



€2,317 million (equivalent)

\$2,060,000,000 6⁵/₈% Senior Secured Notes due 2023

€500,000,000 5¹/₄% Senior Secured Notes due 2023

issued by

ALTICE FINANCING S.A.

\$385,000,000 7⁵/₈% Senior Notes due 2025

issued by

ALTICE FINCO S.A.

Altice Financing S.A., a public limited liability company (*société anonyme*) organized and existing under the laws of the Grand Duchy of Luxembourg (the “Senior Secured Notes Issuer”), a wholly owned direct subsidiary of Altice Finco S.A., a public limited liability company (*société anonyme*) incorporated under the laws of the Grand Duchy of Luxembourg (the “Senior Notes Issuer”, and together with the Senior Secured Notes Issuer, the “Issuers”), which is in turn a wholly owned direct subsidiary of Altice International S.à r.l. (“Altice International”), offered \$2,060 million aggregate principal amount of its 6⁵/₈% senior secured notes due 2023 (the “Dollar Senior Secured Notes”) and €500 million aggregate principal amount of its 5¹/₄% senior secured notes due 2023 (the “Euro Senior Secured Notes”, and together with the Dollar Senior Secured Notes, the “New Senior Secured Notes”) and the Senior Notes Issuer offered \$385 million aggregate principal amount of its 7⁵/₈% senior notes due 2025 (the “New Senior Notes” and, together with the New Senior Secured Notes, the “New Notes”) in connection with the financing of the PT Portugal Acquisition. The New Senior Secured Notes will mature on February 15, 2023 and the New Senior Notes will mature on February 15, 2025. The Issuers will pay interest on the New Notes, as applicable, semi annually in cash in arrears on each April 1 and October 1, commencing on October 1, 2015. Please refer to “*Definitions*” for the meaning of certain capitalized terms used herein.

On the Issue Date (as defined below), the Initial Purchasers deposited (i) the gross proceeds from the offering of the New Senior Secured Notes into segregated escrow accounts in the name of the Senior Secured Notes Escrow Agent (as defined herein) for the benefit of the holders of the New Senior Secured Notes and the Trustee and (ii) the gross proceeds from the offering of the New Senior Notes into a segregated escrow account in the name of the Senior Notes Escrow Agent (as defined herein) for the benefit of the holders of the New Senior Notes and the Trustee. The release of escrow proceeds will be subject to the conditions set forth in “*Description of Senior Secured Notes—Escrow of Proceeds; Special Mandatory Redemption*” and “*Description of Senior Notes—Escrow of Proceeds; Special Mandatory Redemption*”. If the conditions for the release of escrow proceeds are not satisfied prior to June 9, 2016 or upon the occurrence of certain other events, the applicable New Notes will be subject to a special mandatory redemption at 100% of the initial issue price of such New Notes plus accrued and unpaid interest and additional amounts, if any, from the Issue Date. See “*Description of Senior Secured Notes—Escrow of Proceeds; Special Mandatory Redemption*” and “*Description of Senior Notes—Escrow of Proceeds; Special Mandatory Redemption*”.

At any time prior to February 15, 2018, the Senior Secured Notes Issuer may redeem some or all of the New Senior Secured Notes at a price equal to 100% of the principal amount plus a “make whole” premium. At any time on or after February 15, 2018, the Senior Secured Notes Issuer may redeem some or all of the New Senior Secured Notes at the redemption prices set forth herein. In addition, at any time prior to February 15, 2018, the Senior Secured Notes Issuer may redeem up to 40% of the New Senior Secured Notes with the net proceeds from one or more specified equity offerings. Further, the Senior Secured Notes Issuer may redeem all of the New Senior Secured Notes at a price equal to their principal amount plus accrued and unpaid interest and additional amounts, if any, upon the occurrence of certain changes in tax law. If Altice International and its restricted subsidiaries sell certain of their assets, upon the occurrence of

certain events constituting a change of control triggering event (as defined in the Indentures (as defined herein)) or upon certain HOT Minority Shareholder Option Exercises, the Senior Secured Notes Issuer may be required to make an offer to repurchase the New Senior Secured Notes at the prices set forth herein.

At any time prior to February 15, 2020, the Senior Notes Issuer may redeem some or all of the New Senior Notes at a price equal to 100% of the principal amount plus a “make whole” premium. At any time on or after February 15, 2020, the Senior Notes Issuer may redeem some or all of the New Senior Notes at the redemption prices set forth herein. In addition, at any time prior to February 15, 2018, the Senior Notes Issuer may redeem up to 40% of the New Senior Notes with the net proceeds from one or more specified equity offerings. Further, the Senior Notes Issuer may redeem all of the New Senior Notes at a price equal to their principal amount plus accrued and unpaid interest and additional amounts, if any, upon the occurrence of certain changes in tax law. If Altice International and its restricted subsidiaries sell certain of their assets, upon the occurrence of certain events constituting a change of control triggering event (as defined in the Indentures (as defined herein)) or upon certain HOT Minority Shareholder Option Exercises, the Senior Notes Issuer may be required to make an offer to repurchase the New Senior Notes at the prices set forth herein.

The New Senior Secured Notes are senior secured obligations of the Senior Secured Notes Issuer and the New Senior Notes are senior obligations of the Senior Notes Issuer. Prior to the release of all of the proceeds of the offering of the New Senior Secured Notes and the New Senior Notes (as applicable) from the applicable escrow accounts, the New Senior Secured Notes are secured by a first ranking pledge over the Senior Secured Notes Issuer’s rights under the Senior Secured Notes Escrow Agreement and the assets in the Senior Secured Notes Escrow Accounts and the New Senior Notes are secured by a first ranking pledge over the Senior Notes Issuer’s rights under the Senior Notes Escrow Agreement and the assets in the Senior Notes Escrow Account.

The New Notes were not guaranteed on the Issue Date. On the Completion Date, (a) the New Senior Secured Notes will be guaranteed on a senior secured basis (the “Senior Secured Notes Guarantees”) by Altice International, Altice Caribbean S.à r.l. (“Altice Caribbean”), Cool Holding Ltd. (“Cool Holding”), H. Hadaros 2012 Ltd. (“SPV1”), Altice Holdings S.à r.l. (“Altice Holdings”), Altice West Europe S.à r.l. (“Altice West Europe”), green.ch AG (“Green”), Altice Portugal, S.A. (“Altice Portugal”), Cabovisão—Televisão por Cabo, S.A. (“Cabovisão”), Altice Bahamas S.à r.l. (“Altice Bahamas”), Tricom S.A., Global Interlink Ltd., Altice Hispaniola S.A. (“ODO”), Winreason—S.A. (“Winreason”), ONI S.G.P.S., S.A. (“ONI S.G.P.S.”), Onitelem—Infocomunicações, S.A. (“Onitelem”) and Knewon, S.A. (“Knewon”) (collectively, the “Existing Guarantors”), and, within 90 days following the PT Portugal Acquisition, PT Portugal SGPS, S.A. (“PT Portugal”) and MEO—Serviços de Comunicações e Multimédia, S.A. (“PT OpCo”) (the “Acquired Guarantors”, and together with the Existing Guarantors, the “Senior Secured Notes Guarantors”), (b) the New Senior Notes will be guaranteed on a senior subordinated basis (the “Senior Notes Guarantees” and together with the Senior Secured Notes Guarantees, the “Guarantees”) by the Senior Secured Notes Issuer and the Existing Guarantors and, within 90 days following the PT Portugal Acquisition, the Acquired Guarantors (collectively, the “Senior Notes Guarantors”, and together with the Senior Secured Notes Guarantors, the “Guarantors”), (c) the New Senior Secured Notes will benefit from (i) first ranking pledges over all of the share capital of the Senior Secured Notes Issuer and the Existing Guarantors (other than Altice International, Green, Altice Portugal, Cabovisão, Winreason, ONI S.G.P.S., Onitelem and Knewon), Altice Blue One (“ABO”), the capital stock of HOT and, within 10 Business Days following the PT Portugal Acquisition, the share capital of PT Portugal, and within 90 days following the PT Portugal Acquisition, the share capital of PT OpCo, PT Cloud e Data Centers, S.A. (“PT Cloud”), and PT—Móveis—Serviços de Telecomunicações, SGPS, S.A. (“PT Móveis”), (ii) a first ranking pledge over the bank accounts and all receivables of the Senior Secured Notes Issuer, including the Senior Secured Notes Issuer Pledged Proceeds Notes, (iii) subject to certain exceptions, first ranking pledges (or assignments as applicable) over all of the material assets of each Existing Guarantor (other than Cabovisão, Altice Portugal, Winreason, ONI S.G.P.S., Onitelem and Knewon) and, on the closing of the PT Portugal Acquisition, an assignment of claims and rights under the acquisition agreement signed by Altice Portugal in connection with the PT Portugal Acquisition, (iv) a first ranking pledge over the Senior Notes Proceeds Loans, (v) a first ranking pledge over the Cool Shareholder Loan, (vi) a first ranking pledge over the Covenant Party Pledged Proceeds Loans (other than the Onitelem Proceeds Notes and the Cabovisão Proceeds Notes) and (vii) on closing of the PT Portugal Acquisition, a first ranking pledge over the receivables under the AWE Proceeds Loan; and (d) the New Senior Notes and the Senior Notes Guarantees will benefit from (i) a first ranking pledge over all of the share capital of the Senior Notes Issuer, (ii) second ranking pledges over all of the share capital of the Senior Secured Notes Issuer, Cool Holding and Altice Holdings, (iii) a second ranking pledge over the Cool Shareholder Loan and (iv) second ranking pledges of the Senior Notes Proceeds Loans. The collateral securing the New Notes and the Guarantees also secure, on a first or second ranking basis, as applicable, the obligations of the Senior Secured Notes Issuer and the Senior Secured Notes Guarantors under the Senior Secured Debt and the obligations of the Senior Notes Issuer and the Senior Notes Guarantors under the Existing Senior Notes. Under the terms of the Intercreditor Agreement, in the event of an enforcement of the Collateral securing the New Senior Secured Notes, the holders of the New Senior Secured Notes will receive proceeds from such Collateral only after the lenders under the 2012 Revolving Credit Facility, 2013 Revolving Credit Facility, the New Super Senior Revolving Credit Facility and counterparties to certain hedging agreements have been repaid in full. In addition, the security interests in the Collateral may be released under certain circumstances. See “General Description of

our Business and the Offering—The Offering”, “Corporate and Financing Structure” and “Risk Factors—Risks Relating to the New Notes and the Structure”.

See “Risk Factors” beginning on page 52 for a discussion of certain risks that you should consider in connection with an investment in the New Notes.

The New Notes and the Guarantees have not been, and will not be, registered under the U.S. Securities Act of 1933, as amended (the “U.S. Securities Act”), or the securities laws of any other jurisdiction. The Issuers are offering the New Notes only to qualified institutional buyers in accordance with Rule 144A under the U.S. Securities Act and to non-U.S. persons outside the United States in accordance with Regulation S under the U.S. Securities Act. You are hereby notified that the Initial Purchasers may be relying on the exemption from the provisions of Section 5 of the U.S. Securities Act provided by Rule 144A. For a description of certain restrictions on the transfer of the New Notes, see “Plan of Distribution” and “Transfer Restrictions”.

Application has been made to the Luxembourg Stock Exchange for the New Notes to be admitted to listing on the Official List of the Luxembourg Stock Exchange and trading on the Euro MTF Market, which is not a regulated market (pursuant to the provisions of Directive 2004/39/EC).

The Dollar Senior Secured Notes and the New Senior Notes are in registered form in minimum denominations of \$200,000 and integral multiples of \$1,000 above \$200,000. The Euro Senior Secured Notes are in registered form in minimum denominations of €100,000 and integral multiples of €1,000 above €100,000. As of February 4, 2015 (the “Issue Date”), each series of New Notes are being represented by one or more global notes that were delivered through The Depository Trust Company (“DTC”), Euroclear SA/NV (“Euroclear”) and Clearstream Banking, *société anonyme*, as applicable. Interests in each global note will be exchangeable for definitive notes only in certain limited circumstances. See “Book-Entry, Delivery and Form”.

Dollar Senior Secured Notes price: 100.000% plus accrued interest from the Issue Date.

Euro Senior Secured Notes price: 100.000% plus accrued interest from the Issue Date.

New Senior Notes price: 100.000% plus accrued interest from the Issue Date.

Joint Lead Bookrunners

Goldman Sachs International J.P.Morgan Credit Suisse Deutsche Bank Morgan Stanley
BNP PARIBAS Cr dit Agricole CIB Banca IMI Citigroup HSBC Nomura RBC Capital Markets Soci t  G n rale UniCredit Bank

THIS DOCUMENT CONSISTS OF THE LISTING PARTICULARS (THE “LISTING PARTICULARS”) IN CONNECTION WITH THE APPLICATION TO HAVE THE NEW NOTES LISTED ON THE OFFICIAL LIST OF THE LUXEMBOURG STOCK EXCHANGE AND ADMITTED FOR TRADING ON THE EURO MTF MARKET OF THE LUXEMBOURG STOCK EXCHANGE (THE “LISTING”) . THESE LISTING PARTICULARS ARE PROVIDED ONLY FOR THE PURPOSE OF OBTAINING APPROVAL OF ADMISSION OF THE NOTES TO THE OFFICIAL LIST OF THE LUXEMBOURG STOCK EXCHANGE AND ADMISSION FOR TRADING ON THE EURO MTF MARKET OF THE LUXEMBOURG STOCK EXCHANGE AND SHALL NOT BE USED FOR OR DISTRIBUTED FOR ANY OTHER PURPOSE. THESE LISTING PARTICULARS DO NOT CONSTITUTE AN OFFER TO SELL, OR A SOLICITATION OF AN OFFER TO BUY, ANY OF THE NEW NOTES AND THESE LISTING PARTICULARS HAVE NOT BEEN FILED WITH, OR REVIEWED BY, ANY NATIONAL OR LOCAL SECURITIES COMMISSION OR REGULATORY AUTHORITY OF ISRAEL, THE UNITED STATES, THE UNITED KINGDOM, FRANCE, GERMANY, BELGIUM, THE NETHERLANDS, OR ANY OTHER JURISDICTION, NOR HAS ANY SUCH COMMISSION OR AUTHORITY PASSED UPON THE MERITS, ACCURACY OR ADEQUACY OF THESE LISTING PARTICULARS. ANY REPRESENTATION TO THE CONTRARY MAY BE UNLAWFUL AND MAY BE A CRIMINAL OFFENSE.

These Listing Particulars are provided only for the purpose of obtaining approval of admission for trading on the Euro MTF Market of the Luxembourg Stock Exchange and shall not be used for or distributed for any other purpose and these Listing Particulars do not constitute an offer to sell, or a solicitation of an offer to buy, any of the New Notes.

Neither the Issuers nor any of their subsidiaries or affiliates has authorized any dealer, salesperson or other person to give any information or represent anything to you other than the information contained in these Listing Particulars. You must not rely on unauthorized information or representations.

These Listing Particulars does not offer to sell or ask for offers to buy any of the securities in any jurisdiction where it is unlawful, where the person making the offer is not qualified to do so, or to any person who cannot legally be offered the securities.

The information in these Listing Particulars is current only as of the date on the cover page of the Listing Particulars, and may have changed after that date. For any time after the date of the Listing Particulars, the Issuers do not represent that their affairs or the affairs of the Group (as defined herein) are the same as described or that the information in these Listing Particulars are correct, nor do they imply those things by delivering these Listing Particulars or selling securities to you.

The Issuers and the Initial Purchasers (as defined below) are offering to sell the New Notes only in places where offers and sales are permitted.

IN CONNECTION WITH THE OFFERING OF NEW NOTES, GOLDMAN SACHS INTERNATIONAL (THE “STABILIZING MANAGER”) (OR PERSONS ACTING ON BEHALF OF THE STABILIZING MANAGER) MAY OVER-ALLOT NEW NOTES OR EFFECT TRANSACTIONS WITH A VIEW TO SUPPORTING THE MARKET PRICE OF THE NEW NOTES AT A LEVEL HIGHER THAN THAT WHICH MIGHT OTHERWISE PREVAIL. HOWEVER, THERE IS NO ASSURANCE THAT THE STABILIZING MANAGER (OR PERSONS ACTING ON BEHALF OF A STABILIZING MANAGER) WILL UNDERTAKE ANY SUCH STABILIZATION ACTION. SUCH STABILIZATION ACTION, IF COMMENCED, MAY BEGIN ON OR AFTER THE DATE OF ADEQUATE PUBLIC DISCLOSURE OF THE FINAL TERMS OF THE OFFER OF THE NEW NOTES IS MADE AND, IF BEGUN, MAY BE ENDED AT ANY TIME, BUT IT MUST END NO LATER THAN THE EARLIER OF 30 CALENDAR DAYS AFTER THE DATE ON WHICH THE ISSUERS RECEIVED THE PROCEEDS OF THE ISSUE AND 60 CALENDAR DAYS AFTER THE DATE OF ALLOTMENT OF THE NEW NOTES.

The Issuers offered the New Notes in reliance on exemptions from the registration requirements of the U.S. Securities Act. The New Notes have not been registered with, recommended by or approved by the U.S. Securities and Exchange Commission (the “SEC”) or any other securities commission or regulatory authority, nor has the SEC or any such securities commission or authority passed upon the accuracy or adequacy of these Listing Particulars. Any representation to the contrary is a criminal offense in the United States.

These Listing Particulars are being provided for informational use solely in connection with consideration of a purchase of the New Notes (i) to U.S. investors that the Issuers reasonably believe to be qualified institutional buyers as defined in

Rule 144A under the U.S. Securities Act, and (ii) to certain persons in offshore transactions complying with Rule 903 or Rule 904 of Regulation S under the U.S. Securities Act. Its use for any other purpose is not authorized.

These Listing Particulars are directed only to persons who (i) are investment professionals, as such term is defined in Article 19(5) of the Financial Services and Markets Act 2000 (Financial Promotion) Order 2005 (as amended, the “Financial Promotion Order”), (ii) are persons falling within Article 49(2)(a) to (d) (“high net worth companies, unincorporated associations, etc.”) of the Financial Promotion Order, (iii) are outside the United Kingdom, or (iv) are persons to whom an invitation or inducement to engage in investment activity (within the meaning of section 21 of the Financial Services and Markets Act 2000 (“FSM Act”)) in connection with the issue or sale of any New Notes may otherwise lawfully be communicated or caused to be communicated (all such persons together being referred to as “relevant persons”). These Listing Particulars are directed only at relevant persons and must not be acted on or relied on by persons who are not relevant persons. Any investment or investment activity to which these Listing Particulars relates is available only to relevant persons and will be engaged in only with relevant persons.

These Listing Particulars have been prepared on the basis that all offers of the New Notes will be made pursuant to an exemption under Article 3 of Directive 2003/71/EC as amended (the “EU Prospectus Directive”), as implemented in member states of the European Economic Area (the “EEA”), from the requirement to produce a prospectus for offers of the New Notes. Accordingly, any person making or intending to make any offer within the EEA of the New Notes should only do so in circumstances in which no obligation arises for the Issuers or any of the Initial Purchasers to produce a prospectus for such offer. Neither the Issuers nor the Initial Purchasers has authorized, nor do any of them authorize, the making of any offer of the New Notes through any financial intermediary, other than offers made by the Initial Purchasers which constitute the final placement of the New Notes contemplated in these Listing Particulars.

These Listing Particulars constitutes a prospectus for the purpose of part IV of the Luxembourg act dated 10 July 2005 on prospectuses for securities, as amended (the “Prospectus Act”) and for the purpose of the rules and regulations of the Luxembourg Stock Exchange.

The Issuers and Altice International have prepared these Listing Particulars solely for use in connection with this offering and for applying to the Luxembourg Stock Exchange for the New Notes to be admitted to listing on the Official List of the Luxembourg Stock Exchange and to trading on the Euro MTF Market of the Luxembourg Stock Exchange.

You are not to construe the contents of these Listing Particulars as investment, legal or tax advice. You should consult your own counsel, accountant and other advisers as to legal, tax, business, financial and related aspects of a purchase of the New Notes. You are responsible for making your own examination of the Issuers, the Group, the PT Portugal Group and your own assessment of the merits and risks of investing in the New Notes. The Issuers and the Initial Purchasers, the Trustee and their respective agents are not making any representation to you regarding the legality of an investment in the New Notes by you.

The information contained in these Listing Particulars has been furnished by the Issuers, Altice International and other sources they believe to be reliable. No representation or warranty, express or implied, is made by the Initial Purchasers, the Trustee and their respective agents as to the accuracy or completeness of any of the information set out in these Listing Particulars, and nothing contained in these Listing Particulars are or shall be relied upon as a promise or representation by the Initial Purchasers, the Trustee and their respective agents whether as to the past or the future. These Listing Particulars contains summaries, believed by the Issuers and Altice International to be accurate, of some of the terms of specified documents, but reference is made to the actual documents, copies of which will be made available by the Issuers upon request, for the complete information contained in those documents. Copies of such documents and other information relating to the issuance of the New Notes will also be available for inspection upon request at the specified offices of the Issuer. All summaries of the documents contained herein are qualified in their entirety by this reference.

The Issuers and Altice International accept responsibility for the information contained in these Listing Particulars. Each of the Issuers and Altice International have made all reasonable inquiries and confirmed to the best of each of their knowledge, information and belief that the information contained in these Listing Particulars with regard to them, each of its subsidiaries and affiliates, and the New Notes are true and accurate in all material respects, that the opinions and intentions expressed in these Listing Particulars are honestly held, and that they are not aware of any other facts the omission of which would make these Listing Particulars or any statement contained herein misleading in any material respect.

The historical information contained herein regarding PT Portugal and its subsidiaries is primarily based on public filings by Portugal Telecom, SGPS, S.A. and its subsidiaries and we have relied on such information, together with certain limited additional information provided by Portugal Telecom, SGPS, S.A. and/or Oi, in the preparation of this offering memorandum. Neither Portugal Telecom, SGPS, S.A., Oi nor any of their subsidiaries, nor any of their representatives,

officers, employees or advisers, assumes any responsibility for the accuracy or completeness of the information contained herein, and such parties do not have any liability with respect to the New Notes.

No person is authorized in connection with any offering made pursuant to these Listing Particulars to give any information or to make any representation not contained in these Listing Particulars, and, if given or made, any other information or representation must not be relied upon as having been authorized by the Issuers; the Initial Purchasers, the Trustee and their respective agents. The information contained in these Listing Particulars are current at the date hereof. Neither the delivery of these Listing Particulars at any time nor any subsequent commitment to enter into any financing shall, under any circumstances, create any implication that there has been no change in the information set out in these Listing Particulars or in the Issuers' or the Group's affairs since the date of these Listing Particulars.

The Issuers reserve the right to withdraw this offering of the New Notes at any time, and the Issuers and the Initial Purchasers reserve the right to reject any commitment to subscribe for the New Notes in whole or in part and to allot to you less than the full amount of New Notes subscribed for by you.

The distribution of these Listing Particulars and the offer and sale of the New Notes may be restricted by law in some jurisdictions. Persons into whose possession these Listing Particulars or any of the New Notes come must inform themselves about, and observe, any restrictions on the transfer and exchange of the New Notes. See "*Plan of Distribution*" and "*Transfer Restrictions*".

These Listing Particulars does not constitute an offer to sell or an invitation to subscribe for or purchase any of the New Notes in any jurisdiction in which such offer or invitation is not authorized or to any person to whom it is unlawful to make such an offer or invitation. You must comply with all laws that apply to you in any place in which you buy, offer or sell any New Notes or possess these Listing Particulars. You must also obtain any consents or approvals that you need in order to purchase any New Notes. The Issuers and the Initial Purchasers are not responsible for your compliance with these legal requirements.

The New Notes are subject to restrictions on resale and transfer except as permitted under the U.S. Securities Act and all other applicable securities laws as described under "*Plan of Distribution*" and "*Transfer Restrictions*". By purchasing any New Notes, you will be deemed to have made certain acknowledgments, representations and agreements as described in those sections of these Listing Particulars. You may be required to bear the financial risks of investing in the New Notes for an indefinite period of time.

NOTICE TO NEW HAMPSHIRE RESIDENTS

NEITHER THE FACT THAT A REGISTRATION STATEMENT OR AN APPLICATION FOR A LICENSE HAS BEEN FILED UNDER RSA 421-B WITH THE STATE OF NEW HAMPSHIRE NOR THE FACT THAT A SECURITY IS EFFECTIVELY REGISTERED OR A PERSON IS LICENSED IN THE STATE OF NEW HAMPSHIRE CONSTITUTES A FINDING BY THE SECRETARY OF STATE THAT ANY DOCUMENT FILED UNDER RSA 421-B IS TRUE, COMPLETE AND NOT MISLEADING. NEITHER ANY SUCH FACT NOR THE FACT THAT AN EXEMPTION OR EXCEPTION IS AVAILABLE FOR A SECURITY OR A TRANSACTION MEANS THAT THE SECRETARY OF STATE HAS PASSED IN ANY WAY UPON THE MERITS OR QUALIFICATIONS OF, OR RECOMMENDED OR GIVEN APPROVAL TO, ANY PERSON, SECURITY, OR TRANSACTION. IT IS UNLAWFUL TO MAKE, OR CAUSE TO BE MADE, TO ANY PROSPECTIVE PURCHASER, CUSTOMER OR CLIENT ANY REPRESENTATION INCONSISTENT WITH THE PROVISIONS OF THIS PARAGRAPH.

NOTICE TO U.S. INVESTORS

Each purchaser of the New Notes is deemed to have made the representations, warranties and acknowledgements that are described in these Listing Particulars under "*Transfer Restrictions*". The New Notes have not been and will not be registered under the U.S. Securities Act or the securities laws of any state of the United States and are subject to certain restrictions on transferability and resale and may not be transferred or resold except as permitted under the U.S. Securities Act or any other applicable securities laws, pursuant to registration or an exemption therefrom. Prospective purchasers are hereby notified that the seller of any New Note may be relying on the exemption from the provisions of Section 5 of the U.S. Securities Act provided by Rule 144A. For a description of certain further restrictions on resale or transfer of the New Notes, see "*Transfer Restrictions*". The New Notes may not be offered to the public within any jurisdiction. By accepting delivery of these Listing Particulars, you agree not to offer, sell, resell, transfer or deliver, directly or indirectly, any New Note to the public.

NOTICE TO CERTAIN EUROPEAN INVESTORS

Austria These Listing Particulars have not been or will not be approved and/or published pursuant to the Austrian Capital Markets Act (*Kapitalmarktgesetz*) as amended. Neither these Listing Particulars nor any other document connected therewith constitutes a prospectus according to the Austrian Capital Markets Act and neither these Listing Particulars nor any other document connected therewith may be distributed, passed on or disclosed to any other person in Austria. No steps may be taken that would constitute a public offering of the New Notes in Austria and the offering of the New Notes may not be advertised in Austria. Any offer of the New Notes in Austria will only be made in compliance with the provisions of the Austrian Capital Markets Act and all other laws and regulations in Austria applicable to the offer and sale of the New Notes in Austria.

Luxembourg These Listing Particulars have not been approved by and will not be submitted for approval to the Luxembourg Supervision Commission of the Financial Sector (*Commission de Surveillance du Secteur Financier*) for purposes of a public offering or sale in Luxembourg. Accordingly, the New Notes may not be offered or sold to the public in Luxembourg, directly or indirectly, and neither these Listing Particulars nor any other circular, prospectus, form of application, advertisement or other material may be distributed, or otherwise made available in or from, or published in, Luxembourg except in circumstances which do not constitute a public offer of securities to the public, subject to prospectus requirements, in accordance with the Prospectus Act and implementing the EU Prospectus Directive. “EU Prospectus Directive” means Directive 2003/71/EC (and amendments thereto, including the 2010 PD Amending Directive, to the extent implemented in each member state of the EEA which has implemented the EU Prospectus Directive (a “Relevant Member State”)) and includes any relevant implementing measure in each Relevant Member State and the expression “2010 PD Amending Directive” means Directive 2010/73/EU.

Germany The New Notes may be offered and sold in Germany only in compliance with the German Securities Prospectus Act (*Wertpapierprospektgesetz*) as amended, the Commission Regulation (EC) No 809/2004 of April 29, 2004 as amended, or any other laws applicable in Germany governing the issue, offering and sale of securities. The Listing Particulars has not been approved under the German Securities Prospectus Act (*Wertpapierprospektgesetz*) or the Directive 2003/71/EC and accordingly the New Notes may not be offered publicly in Germany.

France These Listing Particulars have not been prepared in the context of a public offering of financial securities in France within the meaning of Article L. 411-1 of the *Code Monétaire et Financier* and Title I of Book II of the *Règlement Général de l'Autorité des marchés financiers* (the “AMF”) and therefore has not been submitted for clearance to the AMF. Consequently, the New Notes may not be, directly or indirectly, offered or sold to the public in France (*offre au public de titres financiers*), and offers and sales of the New Notes will only be made in France to providers of investment services relating to portfolio management for the account of third parties (*personnes fournissant le service d'investissement de gestion de portefeuille pour le compte de tiers*) and/or to qualified investors (*investisseurs qualifiés*) and/or to a closed circle of investors (*cercle restreint d'investisseurs*) acting for their own accounts, as defined in and in accordance with Articles L. 411-1, L. 411-2, D. 411-1, D744-1, D 754-1 and D 764-1 of the *Code of Monétaire et Financier*. Neither these Listing Particulars nor any other offering material may be distributed to the public in France.

Italy No action has been or will be taken which could allow an offering of the Notes to the public in the Republic of Italy within the meaning of Article 1, paragraph 1, letter t) of Legislative Decree No. 58 of February 24, 1998, as subsequently amended (the “**Italian Financial Act**”). Accordingly, the Notes may not be offered or sold directly or indirectly in the Republic of Italy, and neither these Listing Particulars nor any other offering circular, prospectus, form of application, advertisement, other offering material or other information relating to the Issuer, the Notes may be issued, distributed or published in the Republic of Italy, except under circumstances that will result in compliance with all applicable laws, orders, rules and regulations. The Notes cannot be offered or sold in the Republic of Italy either on the primary or on the secondary market to any natural persons or to entities other than qualified investors (*investitori qualificati*) as defined pursuant to Article 100 of the Italian Financial Act and Article 34-ter, paragraph 1, letter b) of Regulation No. 11971 of May 14, 1999 as amended (the “**Issuers Regulation**”) issued by the *Commissione Nazionale per le Società e la Borsa* (“**CONSOB**”) or unless in circumstances which are exempt from the rules on public offers pursuant to the Italian Financial Act and the implementing CONSOB regulations, including the Issuers Regulation.

The Notes may not be offered, sold or delivered and neither these Listing Particulars, and no other material relating to the Notes may be distributed or made available in the Republic of Italy unless such offer, sale or delivery of Notes or distribution or availability of copies of these Listing Particulars or any other material relating to the Notes in Italy is made as follows: (a) by investment firms, banks or financial intermediaries permitted to conduct such activities in Italy in accordance with Legislative Decree No 385 of September 1, 1993 as amended, the Italian Financial Act, CONSOB Regulation No. 16190 of October 29, 2007 as amended and any other applicable laws and regulations; and (b) in compliance with all relevant Italian securities, tax and exchange control and other applicable laws and regulations and any other applicable requirement or limitation which may be imposed from time to time by CONSOB or the Bank of Italy or other competent authority. Any investor purchasing the Notes is solely responsible for ensuring that any offer or resale of the Notes by such investor occurs in compliance with applicable laws and regulations.

The Netherlands The New Notes (including the rights representing an interest in the New Notes in global form) which are the subject of these Listing Particulars, have been and shall be offered, sold, transferred or delivered exclusively to qualified investors (within the meaning of the EU Prospectus Directive) in the Netherlands.

For the purposes of the abovementioned paragraphs, the expression an “offer of notes to the public” in relation to any New Notes in the Netherlands means the announcement or communication in any form and by any means of sufficient information on the terms of the offer and the New Notes to be offered so as to enable an investor to decide to purchase or subscribe for the New Notes and the expression “EU Prospectus Directive” means Directive 2003/71/EC (and amendments thereto, including the 2010 PD Amending Directive) and the expression “2010 PD Amending Directive” means Directive 2010/73/EU.

Spain This offering has not been registered with the Comisión Nacional del Mercado de Valores and therefore the New Notes may not be offered in Spain by any means, except in circumstances which do not qualify as a public offer of securities in Spain in accordance with article 30 bis of the Securities Market Act (“*Ley 24/1988, de 28 de julio del Mercado de Valores*”) as amended and restated, or pursuant to an exemption from registration in accordance with article 41 of the Royal Decree 1310/2005 (“*Real Decreto 1310/2005, de 4 de noviembre por el que se desarrolla parcialmente la Ley 24/1988, de 28 de julio, del Mercado de Valores, en materia de admisión a negociación de valores en mercados secundarios oficiales, de ofertas públicas de venta o suscripción y del folleto exigible a tales efectos*”).

Switzerland The New Notes offered hereby are being offered in Switzerland on the basis of a private placement only. These Listing Particulars, as well as any other material relating to the New Notes which are the subject of the offering contemplated by these Listing Particulars, do not constitute an issue prospectus pursuant to article 652a and/or article 1156 of the Swiss Code of Obligations (SR 220) and does not comply with the Directive for Notes of Foreign Borrowers of the Swiss Bankers’ Association. The New Notes will not be listed on the SIX Swiss Exchange Ltd or any other Swiss stock exchange or regulated trading facility and, therefore, the documents relating to the New Notes, including, but not limited to, these Listing Particulars, do not claim to comply with the disclosure standards of the Swiss Code of Obligations and the listing rules of SIX Swiss Exchange Ltd and corresponding prospectus schemes annexed to the listing rules of the SIX Swiss Exchange Ltd or the listing rules of any other Swiss stock exchange or regulated trading facility. Neither these Listing Particulars nor any other material relating to the New Notes may be publicly distributed or otherwise made publicly available in Switzerland. The New Notes are being offered in Switzerland by way of a private placement (i.e., to a limited number of selected, hand picked investors only), without any public advertisement and only to investors who do not purchase the New Notes with the intention to distribute them to the public. The investors will be individually approached directly from time to time. These Listing Particulars do not constitute an offer to any other person. These Listing Particulars, as well as any other material relating to the New Notes, may not be used in connection with any other offer and shall in particular not be copied and/or distributed to the public in (or from) Switzerland.

United Kingdom These Listing Particulars are directed solely at persons who (i) are investment professionals, as such term is defined in Article 19(5) of the Financial Services and Markets Act 2000 (Financial Promotion) Order 2005, as amended (the “Financial Promotion Order”) (ii) are persons falling within Article 49(2)(a) to (d) (“high net worth companies, unincorporated associations, etc.”) of the Financial Promotion Order (iii) are outside the United Kingdom, or (iv) are persons to whom an invitation or inducement to engage in investment activity (within the meaning of Section 21 of the FMSA) in connection with the issue or sale of any New Notes may otherwise be lawfully communicated or caused to be communicated (all such persons together being referred to as “relevant persons”). These Listing Particulars are directed only at relevant persons and must not be acted on or relied on by persons who are not relevant persons. Any investment or investment activity to which these Listing Particulars relates is available only to relevant persons and will be engaged in only with relevant persons. Any person who is not a relevant person should not act or rely on these Listing Particulars or any of its contents.

Portugal Neither this offering, nor the New Notes have been approved by the Portuguese Securities Commission (*Comissão do Mercado de Valores Mobiliários*—the “CMVM”) or by any other competent authority of another Member State of the European Union and notified to the CMVM.

Neither the Issuers nor the Initial Purchasers have, directly or indirectly, offered or sold any New Notes or distributed or published these Listing Particulars, any prospectus, form of application, advertisement or other document or information in Portugal relating to the New Notes and will not take any such actions in the future, except under circumstances that will not be considered as a public offering under article 109 of the Portuguese Securities Code (*Código dos Valores Mobiliários*—the “Cód.VM”) approved by Decree Law 486/99 of 13 November 1999, as last amended by Decree Law no. 157/2014, of 24 October 2014.

As a result, this offering and any material relating to the New Notes are addressed solely to, and may only be accepted by, any person or legal entity that is resident in Portugal or that will hold the notes through a permanent establishment in Portugal (each a “Portuguese Investor”) to the extent that such Portuguese Investor (i) is deemed a qualified investor (*investidor qualificado*) pursuant to paragraph 1 of article 30 of the Cód.VM, (ii) is not treated by the relevant financial

intermediary as a non-qualified investor (*investidor não qualificado*) pursuant to article 317 of the Cód.VM and (iii) does not request the relevant financial intermediary to be treated as a non-qualified investor (*investidor não qualificado*) pursuant to article 317-A of the Cód.VM.

NOTICE TO ISRAELI INVESTORS

The New Notes may not be offered or sold to any Israeli investor unless such investor (i) is a “Qualified Investor” within the meaning of the first Appendix to the Israeli Securities Law, who is not an individual (a “Qualified Israeli Investor”), (ii) has completed and signed a questionnaire regarding its qualifications as a Qualified Israeli Investor and delivered it to Goldman Sachs International and (iii) has certified that it has an exemption from Israeli withholding taxes on interest and delivered a copy of such certification to Goldman Sachs International.

THIS OFFERING MEMORANDUM CONTAINS IMPORTANT INFORMATION WHICH YOU SHOULD READ BEFORE YOU MAKE ANY DECISION WITH RESPECT TO AN INVESTMENT IN THE NEW NOTES.

DEFINITIONS

Unless otherwise stated or the context otherwise requires, the terms “Group”, “we”, “us” and “our” as used in these Listing Particulars refers to Altice International and its subsidiaries. See “Corporate and Financing Structure” and “The Transactions”. Definitions of certain terms and certain financial and operating data can be found below. For explanations or definitions of certain technical terms relating to our business as used herein, see “Glossary” on page G-1 of these Listing Particulars.

“2012 Acquisition Note” refers to SPV1’s NIS 955.5 million aggregate principal amount of notes due 2019 issued to the Senior Secured Notes Issuer on the 2012 Transaction Completion Date.

“2012 Indentures” refers collectively to the 2012 Senior Notes Indenture and the 2012 Senior Secured Notes Indenture.

“2012 Notes” collectively refers to the 2012 Senior Secured Notes and the 2012 Senior Notes.

“2012 Revolving Credit Facility” refers to the revolving facility agreement, dated November 27, 2012, as amended and restated on December 12, 2012, as further amended, restated, supplemented or otherwise modified from time to time between, *inter alios*, the Senior Secured Notes Issuer, as borrower, the lenders from time to time party thereto, Citibank International PLC as facility agent and Citibank, N.A., London Branch as security agent.

“2012 Senior Notes” refers to the \$425 million aggregate principal amount of 9⁷/₈% senior notes due 2020 issued by the Senior Notes Issuer under the 2012 Senior Notes Indenture.

“2012 Senior Notes Indenture” refers to the indenture dated as of December 12, 2012, as amended, among, *inter alios*, the Senior Notes Issuer, as issuer, the guarantors party thereto and the trustee and the security agent party thereto, governing the 2012 Senior Notes.

“2012 Senior Notes Proceeds Loan” refers to the proceeds loan agreement dated the 2012 Transaction Completion Date between the Senior Notes Issuer and the Senior Secured Notes Issuer pursuant to which the proceeds of the 2012 Senior Notes were on-lent by the Senior Notes Issuer to the Senior Secured Notes Issuer.

“2012 Senior Secured Notes” collectively refers to the €210 million aggregate principal amount of 8% senior secured notes due 2019 and the \$460 million aggregate principal amount of 7⁷/₈% senior secured notes due 2019 issued by the Senior Secured Issuer under the 2012 Senior Secured Notes Indenture.

“2012 Senior Secured Notes Indenture” refers to the indenture dated as of December 12, 2012, among, *inter alios*, the Senior Secured Notes Issuer, as Issuer, the guarantors party thereto and the trustee and the security agent party thereto, governing the 2012 Senior Secured Notes.

“2012 Transaction” collectively refers to the HOT Take Private Transaction, the refinancing of certain indebtedness of Cool Holding and HOT, the entering into of the 2012 Revolving Credit Facility Agreement, the issuance of the HOT Refinancing Notes, the 2012 Acquisition Note and the Cool Proceeds Note, the making of the 2012 Senior Notes Proceeds Loan and the offering and sale of the 2012 Notes.

“2012 Transaction Completion Date” means December 27, 2012, the date on which the 2012 Transaction completed.

“2013 Coditel Acquisition” refers to the acquisition by Altice International of shares in Coditel Holding from certain minority shareholders which was consummated in November 2013.

“2013 December AH Proceeds Loan” refers to the intercompany loan made by the Senior Secured Notes Issuer as lender to Altice Holdings as borrower in connection with the 2013 December Transactions.

“2013 December Senior Notes” refers to the \$400 million aggregate principal amount of 8¹/₈% Senior Notes due 2022 issued by Altice Finco on December 12, 2013.

“2013 December Senior Notes Indenture” refers to the indenture dated as of December 12, 2013, as amended, among, *inter alios*, the Senior Notes Issuer, as issuer, the guarantors party thereto and the trustee and the security agent party thereto, governing the 2013 December Senior Notes.

“2013 December Senior Notes Proceeds Loan” refers to the proceeds loan agreement between the Senior Notes Issuer and the Senior Secured Notes Issuer pursuant to which the proceeds of the 2013 December Senior Notes were on-lent by the Senior Notes Issuer to the Senior Secured Notes Issuer.

“2013 December Transactions” refers to the acquisition of ODO which was consummated on April 9, 2014, the acquisition of Tricom which was consummated on March 12, 2014, and the related issuance of the 2013 December Senior Notes, 2013 December Dollar Senior Secured Notes, and 2013 December Euro Senior Secured Notes to fund such acquisitions.

“2013 December Dollar Senior Secured Notes” refers to the \$900 million aggregate principal amount of 6¹/₂% Senior Secured Notes due 2022 issued by Altice Financing on December 12, 2013.

“2013 December Euro Senior Secured Notes” refers to the €300 million aggregate principal amount of 6¹/₂% Senior Secured Notes due 2022 issued by Altice Financing on December 12, 2013.

“2013 December Senior Secured Notes” collectively refers to the 2013 December Dollar Senior Secured Notes and the 2013 December Euro Senior Secured Notes.

“2013 December Senior Secured Notes Indenture” refers to the indenture dated as of December 12, 2013, as amended, among, *inter alios*, the Senior Secured Notes Issuer, as issuer, the guarantors party thereto and the trustee and the security agent party thereto, governing the 2013 December Senior Secured Notes.

“2013 Guarantee Facility” refers to the 2013 Guarantee Facility agreement dated July 1, 2013, as amended, restated, supplemented or otherwise modified from time to time, between, *inter alios*, the Senior Secured Notes Issuer as borrower, the lenders from time to time party thereto, Wilmington Trust (London) Limited as facility agent and Citibank, N.A., London Branch as security agent.

“2013 June AH Proceeds Loan” refers to the intercompany loan made by the Senior Secured Notes Issuer as lender to Altice Holdings as borrower in connection with the 2013 June Transactions.

“2013 June Senior Notes” refers to the €250 million aggregate principal amount of 9% senior notes due 2023 of the Senior Notes Issuer issued by the Senior Notes Issuer under the 2013 June Senior Notes Indenture.

“2013 June Senior Notes Indenture” refers to the indenture dated as of June 14, 2013, as amended, among, *inter alios*, the Senior Notes Issuer, as issuer, the guarantors party thereto and the trustee and the security agent party thereto, governing the 2013 June Senior Notes.

“2013 June Senior Notes Proceeds Loan” refers to the intercompany loan made with the proceeds of the offering of the 2013 June Senior Notes by the Senior Notes Issuer as lender to the Senior Secured Notes Issuer as borrower in connection with the 2013 June Transactions.

“2013 June Transactions” refers collectively to the Fold-in, the ABO Refinancing, the Cabovisão Refinancing, the Coditel Refinancing, the ONI Transaction, the Outremer Transaction, the 2013 Coditel Acquisition, the issuance of the 2013 June Senior Notes and the entry into the 2013 Revolving Credit Facility, 2013 Term Loan and the 2013 Guarantee Facility.

“2013 Revolving Credit Facility” refers to the revolving facility agreement, dated July 1, 2013, as amended, restated, supplemented or otherwise modified from time to time, between, *inter alios*, the Senior Secured Notes Issuer as borrower, the lenders from time to time party thereto Citibank International PLC as facility agent and Citibank, N.A., London Branch as security agent.

“2013 Term Loan” refers to the term loan credit agreement dated June 24, 2013, as amended, restated, supplemented or otherwise modified from time to time, between, *inter alios*, the Senior Secured Notes Issuer as borrower and the persons listed in Schedule 2.01 thereto as lenders, Goldman Sachs Lending Partners LLC as the Administrative Agent and Citibank, N.A., London Branch as Security Agent.

“ABO” refers to Altice Blue One S.A.S., a *société par actions simplifiée*, incorporated under the laws of France.

“ABO Proceeds Loan” refers to the intercompany loan made by Altice Holdings as lender to ABO as borrower in connection with the ABO Refinancing and the 2013 June Transactions.

“ABO Refinancing” refers to ABO’s refinancing of approximately € 70 million of its existing indebtedness to third parties with the proceeds of the 2013 Term Loan and the 2013 June Senior Notes on July 2, 2013.

“ABT Convertible Bonds” refers to the convertible bonds issued by Altice Blue Two and subscribed for by Altice Caribbean in connection with the Outremer Transaction and the 2013 June Transactions.

“Aggregate Portuguese Security and Guarantee Limit” refers to, as applicable, (1) €95 million, representing the maximum aggregate amount of obligations (i) guaranteed by Altice Portugal and Cabovisão and (ii) secured by the Cabovisão Security (including the pledge over the shares in PT Portugal, to be granted by Altice Portugal within 10 Business Days following the PT Portugal Acquisition), which limitation applies to all indebtedness so guaranteed and/or secured on an aggregate basis; (2) €45,807,869.98, representing the maximum aggregate amount of obligations secured by the ONI Security and guaranteed by the ONI Group, which limitation applies to all indebtedness so secured and/or guaranteed on an aggregate basis; and (3) (i) up to € 4,634.4 million for PT Portugal and (ii) €968.4 million for PT OpCo, representing the maximum aggregate amount of obligations secured by PT Portugal and PT OpCo, respectively, and guaranteed by PT Portugal and PT OpCo, respectively, which limitation applies to all indebtedness so secured and/or guaranteed on an aggregate basis.

“Altice” or “Altice International” refers to Altice International S.à r.l., a private limited liability company (*société à responsabilité limitée*), formerly named Altice VII S.à r.l., incorporated under the laws of the Grand Duchy of Luxembourg.

“Altice Bahamas” refers to Altice Bahamas S.à r.l., a private limited liability company (*société à responsabilité limitée*), incorporated under the laws of the Grand Duchy of Luxembourg.

“Altice Blue Two” refers to Altice Blue Two S.A.S., a private limited liability company (*société par actions simplifiée*) incorporated under the laws of France.

“Altice Caribbean” refers to Altice Caribbean S.à r.l. a private limited liability company incorporated under the laws of the Grand Duchy of Luxembourg.

“Altice France Group” refers to Numericable-SFR S.A. and its subsidiaries after giving effect to the acquisition of SFR by the Numericable Group.

“Altice Group” refers to, collectively, Altice S.A. and its subsidiaries and includes the Group and the Numericable Group, unless the context otherwise requires.

“Altice Holdings” refers to Altice Holdings S.à r.l., a private limited liability company (*société à responsabilité limitée*), incorporated under the laws of the Grand Duchy of Luxembourg.

“Altice Portugal” refers to Altice Portugal, S.A. (formerly known as Rightproposal—Telecomunicações, S.A.), a public limited liability company (*sociedade anónima*) incorporated under the laws of Portugal.

“Altice West Europe” refers to Altice West Europe S.à r.l. a private limited liability company (*société à responsabilité limitée*) incorporated under the laws of the Grand Duchy of Luxembourg.

“AP Proceeds Loan” refers to the intercompany loan made by Altice West Europe as lender to Altice Portugal, and any successor entity, as borrower, in connection with the New Transactions.

“ASA Notes Proceeds Contribution” refers to the €2,055 million (equivalent), equal to the proceeds of the New ASA Senior Notes, to be contributed by Altice S.A. to Altice International in exchange for mandatory convertible notes of €2,055 million aggregate value (in €100,000 nominal value each) to be issued by Altice International and to be subscribed to by Altice S.A., and Altice International in turn will contribute such proceeds to Altice Holdings.

“AWE Proceeds Loan” refers to the intercompany loan made by Altice Holdings as lender to Altice West Europe, and any successor entity, as borrower, in connection with the New Transactions.

“Business Day” means each day that is not a Saturday, Sunday or other day on which banking institutions in London, United Kingdom, the Grand Duchy of Luxembourg or New York, New York, United States are authorized or required by law to close.

“Cabovisão” refers to Cabovisão—Televisão por Cabo, S.A., a public limited liability company (*sociedade anónima*) incorporated under the laws of Portugal.

“Cabovisão Proceeds Notes” refers to the outstanding bonds issued by Cabovisão and subscribed for by Altice Holdings on April 23, 2013 (“Original Cabovisão Proceeds Notes”) and on July 2, 2013 (“New Cabovisão Proceeds Notes”).

“Cabovisão Refinancing” refers to the repayment by Altice Financing of the outstanding indebtedness under the Refinanced Cabovisão Bridge Facility of €203 million with the proceeds of the 2013 Term Loan and the 2013 June Senior Notes on July 2, 2013.

“Cabovisão Security” refers to the security interests governed by Portuguese law created by Altice Holdings, Altice West Europe (if applicable), Altice Portugal and Cabovisão and as amended from time to time.

“Carve Out Reorganization” refers to the reorganization of PT Portugal and its subsidiaries required to be completed by Oi S.A. under the terms of the PT Portugal Acquisition Agreement so that, among other things, upon the completion of the PT Portugal Acquisition, PT Portugal shall no longer own any interests in the Asian entities and assets, African entities and assets, other than Open Ideia (Angola), Open Ideia (Morocco) and Contact Cabo Verde, or in the financing vehicles that are currently part of the PT Portugal perimeter. In particular, the commercial paper and any other securities issued by Rio Forte Investments S.A shall not be included in the assets comprising the PT Portugal Group.

“Clearstream” refers to Clearstream Banking, *société anonyme*.

“Coditel Belgium” refers to Coditel Brabant S.P.R.L., a private limited liability company (*société privée à responsabilité limitée*) incorporated under the laws of Belgium.

“Coditel Holding” or “Coditel Holding S.A.” or “Coditel” refers to Coditel Holding S.A., a public limited liability company (*société anonyme*) incorporated under the laws of Luxembourg, or collectively, Coditel Holding S.A. and its subsidiaries as the context requires.

“Coditel Luxembourg” refers to Coditel S.à r.l., a private limited liability company (*société à responsabilité limitée*) incorporated under the laws of Luxembourg.

“Coditel Senior Facilities Agreement” refers to the senior facilities agreement, dated November 29, 2011, among, *inter alios*, Coditel Holding Lux S.à r.l. as parent, Coditel Holding as the company, GE Corporate Finance Bank S.A.S., HSBC France, ING Belgium SA/NV, KBC Bank NV and Natixis as mandated lead arrangers, ING Bank N.V. as agent and security agent.

“Collateral” refers to the Senior Secured Collateral and the Senior Notes Collateral (other than, if the context so requires, the first ranking pledge over all of the share capital of the Senior Notes Issuer).

“Completion Date” refers to the date on which the PT Portugal Acquisition is consummated.

“Cool Holding” refers to Cool Holding Ltd., (a) a public limited liability company (*société anonyme*) incorporated under the laws of Luxembourg and (b) a private limited liability company incorporated under the laws of Israel.

“Cool Proceeds Note” refers to Cool Holding’s NIS 1,052.8 million aggregate principal amount of notes due 2019 issued to the Senior Secured Notes Issuer on the 2012 Transaction Completion Date.

“Cool Shareholder Loan” refers to the amended and restated interest free loan agreement dated January 11, 2013 between Altice International and Cool Holding pursuant to which Altice International agreed to grant Cool Holding a loan in a maximum aggregate amount of NIS 1.5 billion.

“Covenant Party Pledged Proceeds Loans” has the meaning ascribed to it under “*Corporate and Financing Structure*”.

“Dollar Senior Secured Notes” refers to the \$2,060 million aggregate principal amount of 6⁵/₈% New Senior Secured Notes due 2023 offered hereby.

“DTC” refers to The Depository Trust Company.

“Escrow Accounts” refers to the Senior Secured Notes Escrow Accounts and the Senior Notes Escrow Account.

“Escrow Agent” refers to the Senior Secured Notes Escrow Agent or the Senior Notes Escrow Agent and “Escrow Agents” refers to them collectively.

“Euro Senior Secured Notes” refers to the €500 million aggregate principal amount of 5¹/₄% New Senior Secured Notes due 2023 offered hereby.

“Euroclear” refers to Euroclear Bank SA/NV.

“Existing Coditel Intercreditor Agreement” refers to the intercreditor agreement, dated November 29, 2011 between, *inter alios*, Coditel Holding Lux S.à r.l., Coditel Holding, the companies listed therein as original debtors, ING Bank N.V. as senior agent, Wilmington Trust (London) Limited as mezzanine agent and ING Bank N.V. as security agent.

“Existing Coditel Mezzanine Facility” refers to the facility that was available under the Existing Coditel Mezzanine Facility Agreement.

“Existing Coditel Mezzanine Facility Agreement” refers to the mezzanine facility agreement, dated November 29, 2011, among, *inter alios*, Coditel Holding Lux S.à r.l., Coditel Holding as the company, Wilmington Trust (London) Limited as agent and ING Bank N.V. as security agent.

“Existing Coditel Proceeds Loan” refers to the existing proceeds loan agreement between Coditel Holding as lender and Coditel Belgium as borrower.

“Existing HOT Unsecured Notes” refers to the NIS 825 million notes (Series A) and the NIS 675 million notes (Series B) of HOT, offered to Israeli investors pursuant to an Israeli shelf offering report dated March 29, 2011 under an Israeli shelf prospectus dated February 28, 2011, as amended on March 29, 2011, and as amended from time to time.

“Existing Indentures” collectively refers to the 2013 December Senior Secured Notes Indenture, the 2013 December Senior Notes Indenture, the 2013 June Senior Notes Indenture, the 2012 Senior Notes Indenture and the 2012 Senior Secured Notes Indenture and “Existing Indenture” refers to the 2013 December Senior Secured Notes Indenture, the 2013 December Senior Notes Indenture, the 2013 June Senior Notes Indenture, 2012 Senior Notes Indenture or the 2012 Senior Secured Notes Indenture, as the context requires.

“Existing Revolving Credit Facility Agreements” collectively refers to the 2012 Revolving Credit Facility and the 2013 Revolving Credit Facility.

“Existing Senior Notes” collectively refers to the 2013 December Senior Notes, the 2013 June Senior Notes and the 2012 Senior Notes.

“Existing Senior Notes Indentures” collectively refers to the 2013 December Senior Notes Indenture, the 2013 June Senior Notes Indenture and the 2012 Senior Notes Indenture and “Existing Senior Notes Indenture” refers to the 2013 December Senior Notes Indenture, the 2013 June Senior Notes Indenture and 2012 Senior Notes Indenture, as the context requires.

“Existing Senior Notes Proceeds Loans” collectively refers to the 2013 December Senior Notes Proceeds Loan, the 2012 Senior Notes Proceeds Loan and the 2013 June Senior Notes Proceeds Loan.

“Existing Senior Secured Notes” collectively refers to the 2012 Senior Secured Notes and the 2013 December Senior Secured Notes.

“Existing Senior Secured Guarantors” collectively refers to Altice International, Cool Holding, SPV1, Altice Holdings, Altice West Europe, Altice Caribbean, Green, Altice Portugal, Cabovisão, Winreason, ONI S.G.P.S., Onitelecom, Knewon, Altice Bahamas, ODO, Tricom (and in respect of the 2012 Notes and the 2013 June Senior Notes only, ABO).

“Fold-in” refers to the designation of Altice Holdings as a covenant party under the 2012 Indentures and the transfer by Altice International of all of the share capital of Altice Holdings and certain of its subsidiaries, including Altice Portugal, Cabovisão, Coditel Holding, ABO, Green and Le Cable into the Restricted Group in connection with the 2013 June Transactions.

“French Overseas Territories” refers to Guadeloupe, Martinique, French Guiana, La Réunion and Mayotte.

“Global Interlink Ltd.” refers to Global Interlink Ltd., a corporation organized under the laws of The Bahamas.

“GOT On-Loan” refers to the intercompany loan entered into between OMT Invest as lender and Groupe Outremer Telecom as borrower in connection with the Outremer Transaction.

“Green” refers to green.ch AG (company registration no. CHE- 113.574.742; formerly Solution25 AG), a Swiss company limited by shares (*Aktiengesellschaft*), incorporated and existing under the laws of Switzerland, a non-wholly owned subsidiary of Altice International Group (the minority shareholders having a participation in Green of approximately 0.23%, see “*Simplified Corporate and Financing Structure*” below).

“Green Datacenter” refers to Green Datacenter AG (company registration no. CHE-115.555.342), a Swiss company limited by shares (*Aktiengesellschaft*), incorporated and existing under the laws of Switzerland.

“Group” or “Altice International Group” refers to Altice International and its subsidiaries, unless the context otherwise requires.

“Groupe Outremer Telecom” refers to Groupe Outremer Telecom S.A., a public limited liability company incorporated under the laws of France, or collectively, Groupe Outremer Telecom S.A. and its subsidiaries as the context requires.

“Guarantees” collectively refers to the Senior Notes Guarantees and the Senior Secured Notes Guarantees.

“Guarantors” collectively refers to the Senior Notes Guarantors and the Senior Secured Notes Guarantors.

“HOT” refers to HOT Telecommunication Systems Ltd., or collectively, HOT Telecommunication Systems Ltd. and its subsidiaries as the context requires.

“HOT Minority Shareholders” has the same meaning given to the term “Minority Shareholder” in “*Description of Senior Secured Notes*”.

“HOT Minority Shareholder Agreements” has the meaning given to such term in “*Description of Our Business*”.

“HOT Minority Shareholder Call Options” has the same meaning given to the term “Minority Shareholder Call Option” in “*Description of Senior Secured Notes*”.

“HOT Minority Shareholder Option Exercises” has the same meaning given to the term “Minority Shareholder Option Exercise” in the “*Description of Senior Secured Notes*”.

“HOT Mobile” refers to HOT Mobile Ltd., formerly known as MIRS Communications Ltd.

“HOT Net” refers to HOT Net Internet Services Ltd.

“HOT Proceeds RCF Note” refers to HOT’s NIS 320 million aggregate principal amount of notes issued to the Senior Secured Notes Issuer on the 2012 Transaction Completion Date subject to the terms of the revolving loan agreement dated December 27, 2012 among the Senior Secured Notes Issuer, HOT, the HOT Refinancing Note Guarantors and Citibank, N.A., London Branch as security agent.

“HOT Proceeds Term Note” refers to HOT’s NIS 1,900 million aggregate principal amount of notes issued to the Senior Secured Notes Issuer on the 2012 Transaction Completion Date.

“HOT Refinancing Note Collateral” refers to the pledge over substantially all of the assets of HOT (including all of the share capital of HOT Mobile) and the HOT Refinancing Note Guarantors securing the HOT Refinancing Notes, but, in each case, excluding licenses granted by the Israeli Ministry of Communication and certain end-user equipment, with respect to which HOT is not permitted to grant a security interest, securing the HOT Refinancing Notes.

“HOT Refinancing Note Guarantors” refers to HOT Net, HOT Telecom Limited Partnership, Hot Vision Ltd., HotIdan Cable Systems Israel Ltd., HotIdan Cable Systems (Holdings) 1987 Ltd., HotEdom Ltd., Hot T.L.M Subscribers Television Ltd. and HotCable System Media Haifa Hadera Ltd.

“HOT Refinancing Notes” collectively refers to the HOT Proceeds RCF Note and the HOT Proceeds Term Note.

“HOT Take Private Transaction” refers to the acquisition by Cool Holding and SPV1 of all the outstanding shares of HOT (other than certain share options) and the subsequent delisting from the Tel Aviv Stock Exchange of the shares of HOT, which was completed on the 2012 Transaction Completion Date.

“IFRS” refers to the International Financial Reporting Standards as adopted by the European Union, unless the context otherwise requires.

“Initial Purchasers” refers to Goldman Sachs International, and with respect to the Dollar Notes, J.P. Morgan Securities LLC, Deutsche Bank Securities Inc. and Nomura Securities International, Inc., and with respect to the Euro Senior Secured Notes, J.P. Morgan Securities plc, Deutsche Bank AG, London Branch and Nomura International plc, and with respect to all Securities, Credit Suisse Securities (Europe) Limited, Morgan Stanley & Co. International plc, BNP

Paribas, Crédit Agricole Corporate and Investment Bank, Banca IMI S.p.A., Citigroup Global Markets Limited, HSBC Bank plc, RBC Europe Limited, Société Générale and UniCredit Bank AG.

“Intercreditor Agreement” refers to the intercreditor agreement dated December 12, 2012, as amended from time to time, among, *inter alios*, the Senior Notes Issuer, the Senior Secured Notes Issuer, Cool Holding, and Citibank, N.A., London Branch, as the Security Agent.

“Issuers” refers to the Senior Notes Issuer and the Senior Secured Notes Issuer.

“Knewon” refers to Knewon, S.A., a public limited liability company (*sociedade anónima*) incorporated under the laws of Portugal.

“Le Cable” collectively refers to Le Cable Martinique and Le Cable Guadeloupe.

“Le Cable Guadeloupe” refers to World Satellite Guadeloupe S.A., a public limited liability (*société anonyme*) company incorporated under the laws of France.

“Le Cable Martinique” refers to Martinique TV Câble S.A. a public limited liability company (*société anonyme*) incorporated under the laws of France.

“Le Cable Proceeds Loans” collectively refers to the intercompany loans by Altice Holdings as lender to Le Cable Martinique and Le Cable Guadeloupe as borrowers in connection with the refinancing of Le Cable and the 2013 June Transactions.

“Luxembourg” refers to the Grand Duchy of Luxembourg.

“Meo, S.A.” refers to the former MEO—Serviços de Comunicações e Multimédia, S.A., a public limited liability company (*sociedade anónima*) incorporated under the laws of Portugal with registration number 502 600 268, which was merged into the former PT Comunicações, S.A. on December 29, 2014.

“Mobius” or “Mobius Group” means the group headed by Mobius S.A.S., a private limited liability company (*société par actions simplifiée*) incorporated under the laws of France.

“Mobius Acquisition” refers to the acquisition by Altice Blue Two (a wholly-owned subsidiary of Altice International) of the Mobius Group in January 2014.

“Mobius Transaction” refers collectively to the following transactions: (i) the Mobius Acquisition and (ii) the reinvestment of certain managers of the Mobius Group in Altice S.A.

“New AH Proceeds Loans” refers to the intercompany loans made by the Senior Secured Notes Issuer as lender to Altice Holdings, and any successor entity, as borrower, in connection with the New Transactions.

“New ASA Senior Notes” refers to the senior notes due 2025 to be issued by Altice S.A. on or about the Issue Date.

“New Indentures” refers to the New Senior Secured Notes Indenture and the New Senior Notes Indenture.

“New Notes” refers to the New Senior Secured Notes and the New Senior Notes, collectively.

“New Pari Passu Revolving Credit Facility” has the meaning given to such term in “*Description of Other Indebtedness*”.

“New Revolving Credit Facilities” collectively refers to the facilities under the New Super Senior Revolving Credit Facility and the New Pari Passu Revolving Credit Facility.

“New Senior Notes” refers to the \$385 million aggregate principal amount of 7⁵/₈% senior notes due 2025 offered hereby.

“New Senior Notes Indenture” refers to the indenture governing the New Senior Notes.

“New Senior Notes Proceeds Loan” refers to the proceeds loan agreement between the Senior Notes Issuer and the Senior Secured Notes Issuer pursuant to which the proceeds of the New Senior Notes will be on-lent by the Senior Notes Issuer to the Senior Secured Notes Issuer on the date of completion of the PT Portugal Acquisition.

“New Senior Secured Notes” refers to, collectively, the Euro Senior Secured Notes and the Dollar Senior Secured Notes.

“New Senior Secured Notes Indenture” refers to the indenture governing the New Senior Secured Notes.

“New Super Senior Revolving Credit Facility” has the meaning given to such term in “*Description of Our Business*”.

“New Term Loan” or “New Senior Credit Facility” refers to the term loan credit agreement dated on or about the Issue Date, among, *inter alios*, the Senior Secured Notes Issuer as borrower, the lenders from time to time party thereto and Deutsche Bank, A.G., London Branch and Deutsche Bank A.G., New York Branch as administrative agents and Citibank, N.A., London Branch as security agent.

“New Transactions” has the meaning ascribed to it under “*The Transactions*”.

“Noteholder” refers to a holder of the New Notes.

“Numericable Group” refers to Numericable-SFR S.A. (formerly known as Numericable Group S.A.) and its subsidiaries.

“ODO” refers to Altice Hispaniola S.A., formerly named Orange Dominicana S.A.

“ODO Acquisition” refers to the acquisition by Altice Dominican Republic II S.A.S. of ODO which was completed on April 9, 2014.

“OMT Invest” refers to OMT Invest S.A.S., a private limited liability company (*Société par actions simplifiée*), incorporated under the laws of France.

“ONI” and “ONI Group” refer to Winreason, ONI S.G.P.S., Onitelecom, Knewon, S.A. and/or their subsidiaries as the context requires.

“ONI Acquisition” refers to the purchase by Cabovisão of all of the outstanding shares of Winreason and Winreason shareholders’ credits, which was consummated on August 8, 2013.

“ONI Facility Agreement” refers to the facility agreement dated November 10, 2011 between, amongst others, Onitelecom, as borrower, and Banco Efisa, S.A., as agent.

“ONI Hedging Agreements” refers to the hedging agreements entered into by Onitelecom in connection with the ONI Facility Agreement.

“ONI Refinancing” refers to, collectively, the repayment of the outstanding indebtedness under the ONI Facility Agreement by Altice Financing and the termination of, and repayment of the outstanding indebtedness under, the ONI Hedging Agreements by Onitelecom, which were consummated on August 8, 2013.

“ONI S.G.P.S.” means ONI S.G.P.S., S.A. a holding company (*sociedade gestora de participações sociais*) incorporated under the laws of Portugal.

“ONI Security” refers to the security interests governed by Portuguese law created by Winreason, ONI, S.G.P.S. and its subsidiaries under the ONI Security Agreement and as amended from time to time.

“ONI Security Agreement” refers to the security agreement dated 10 November 10, 2011 among, *inter alios*, Winreason, ONI S.G.P.S., Onitelecom, Hubgrade, S.A., F300—Fiber Communications, S.A. and Knewon, S.A., as pledgors, and Banco Efisa, S.A., as security agent (as amended and restated on August 8, 2013).

“ONI Transaction” refers to, collectively, the ONI Acquisition and the ONI Refinancing.

“Onitelecom” means Onitelecom—Infocomunicações, S.A., a public limited liability company (*sociedade anónima*) incorporated under the laws of Portugal.

“Onitelecom Proceeds Notes” refers to the outstanding bonds issued by ONI and subscribed for by Altice Holdings.

“Outremer” refers to Groupe Outremer Telecom and its subsidiaries.

“Outremer Investment Agreement” refers to the investment agreement between the parties to the Outremer Purchase Agreement.

“Outremer Minority Shareholders” has the meaning ascribed to it under “*Description of our Business—Material Contracts—Certain Shareholder Arrangements—French Overseas Territories*”.

“Outremer Proceeds Loans” collectively refers to the intercompany loans made by Altice Holdings as lender to Altice Caribbean, Altice Blue Two, OMT Invest and Outremer Telecom as borrowers in connection with the Outremer Transaction.

“Outremer Purchase Agreement” refers to the sale and purchase agreement dated June 7, 2013 between Altice International and certain of its subsidiaries and the existing investors in, and certain managers of, OMT Invest and certain of its affiliates.

“Outremer Transaction” refers collectively to the following transactions: (i) the purchase by Altice (through Altice Blue Two) of all of the outstanding share capital of OMT Invest other than shares that were contributed separately by the Outremer Minority Shareholders pursuant to the Outremer Investment Agreement and the refinancing of all of the outstanding indebtedness of OMT Invest and its subsidiaries pursuant to the Outremer Purchase Agreement; and (ii) the contribution by the Group of all of the outstanding share capital of Le Cable Martinique and Le Cable Guadeloupe to Altice Blue Two and the contribution by the managers of OMT Invest of substantially all of the outstanding shares of OMT Invest not sold to Altice under the Outremer Purchase Agreement to Altice Blue Two pursuant to the Outremer Investment Agreement. The Outremer Transaction was consummated on July 5, 2013.

“Overseas Territories” refers to the French Overseas Territories and the Dominican Republic.

“Pledged Proceeds Notes” collectively refers to the Covenant Party Pledged Proceeds Loans and the Senior Secured Notes Issuer Pledged Proceeds Notes.

“PT Cloud” means PT Cloud e Data Centers, S.A., a public limited liability company (*sociedade anónima*) incorporated under the laws of Portugal.

“PT OpCo” refers to MEO—Serviços de Comunicações e Multimédia, S.A., a public limited liability company (*sociedade anónima*) incorporated under the laws of Portugal with registration number 504 615 947, which was formerly known as PT Comunicações, S.A. and is the surviving entity from the merger of Meo, S.A. into PT Comunicações, S.A. on December 29, 2014.

“PTC” means PT Comunicações S.A., a public limited liability company (*sociedade anónima*) incorporated under the laws of Portugal and registered with the Commercial Registry Office of Lisbon under the registration number 504 615 947.

“PT Group Loans” refers to the intercompany loans made by (i) Altice Portugal as lender to PT Portugal as borrower, (ii) PT Portugal as lender to PT Opco as borrower, (iii) PT Opco as lender to PT Móveis as borrower and (iv) PT Móveis as lender to SIRESP as borrower, in each case, in connection with the Transactions.

“PT Móveis” means PT—Móveis—Serviços de Telecomunicações, SGPS, S.A., a public limited liability company (*sociedade anónima*) incorporated under the laws of Portugal.

“PT Portugal” means PT Portugal SGPS, S.A., a public limited liability company (*sociedade anónima*) incorporated under the laws of Portugal.

“PT Portugal Acquisition” refers to the acquisition by Altice International (through one of its subsidiaries) of 100% of the issued share capital of PT Portugal.

“PT Portugal Acquisition Agreement” refers to the agreement entered into between Altice S.A. and Altice Portugal with Oi S.A. relating to 100% of the issued share capital of PT Portugal.

“PT Portugal Group” refers to the entities that will be acquired pursuant to the PT Portugal Acquisition. For a list of these entities, see “*PT Portugal Combined Selected Financial Information—Basis of Preparation*”.

“PT Portugal Security” refers to the security interests created by certain members of the PT Portugal Group and Altice Portugal under the PT Portugal Security Documents and as amended from time to time.

“PT Portugal Security Documents” refer to, collectively, (i) the agreement for the assignment of claims and rights under the PT Portugal Acquisition Agreement, (ii) the share pledge agreement creating a first ranking pledge over all of the shares of PT Portugal and, (iii) the share pledge agreement creating a first ranking pledge over all of the shares of PT OpCo, PT Cloud and PT Móveis and any other instrument and document executed and delivered pursuant to the New Senior Secured Notes Indenture or otherwise in connection with the foregoing, as the same may be amended, supplemented or otherwise modified from time to time, creating the security interests granted by some of the members of the PT Portugal Group in the relevant Notes Collateral as contemplated by the New Senior Secured Notes Indenture.

“Refinanced Cabovisão Bridge Facility” refers to the facility agreement, dated March 6, 2013 (as amended and restated on April 18, 2013), among, *inter alios*, Altice Holdings, as the borrower, Altice International, as the parent, Altice Portugal and Cabovisão, as original guarantors, Goldman Sachs International, Morgan Stanley Bank International Limited and Crédit Agricole Corporate and Investment Bank, as the arrangers, and Wilmington Trust (London) Limited as agent and security agent, which was refinanced pursuant to the Cabovisão Refinancing and the 2013 June Transactions.

“Restricted Group” refers to Altice International and its subsidiaries, other than Green Datacenter and Auberimmo.

“Security Agent” refers to Citibank, N.A., London Branch.

“Senior Notes” collectively refers to the New Senior Notes and the Existing Senior Notes.

“Senior Notes Collateral” has the meaning ascribed to it under “*The Offering—Security—New Senior Notes*”.

“Senior Notes Escrow Account” has the meaning ascribed to it under “*The Offering—Escrow of Proceeds; Special Mandatory Redemption*”.

“Senior Notes Escrow Agent” refers to an affiliate of one of the Initial Purchasers, acting in its capacity as escrow agent under the Senior Notes Escrow Agreement.

“Senior Notes Escrow Agreement” has the meaning ascribed to it under “*The Offering—Escrow of Proceeds; Special Mandatory Redemption*”.

“Senior Notes Guarantees” has the meaning ascribed to it under “*The Offering—Guarantees—Senior Notes*”.

“Senior Notes Guarantors” has the meaning ascribed to it under “*The Offering—Guarantees—Senior Notes*”.

“Senior Notes Issuer” refers to Altice Finco S.A., a public limited liability company (*société anonyme*), incorporated under the laws of Luxembourg.

“Senior Notes Proceeds Loans” collectively refers to the 2012 Senior Notes Proceeds Loan, the 2013 June Senior Notes Proceeds Loan, the 2013 December Senior Notes Proceeds Loans and the New Senior Notes Proceeds Loan.

“Senior Secured Collateral” has the meaning ascribed to it under “*The Offering—Security—New Senior Secured Notes*”.

“Senior Secured Debt” refers to the 2012 Senior Secured Notes, the 2012 Revolving Credit Facility, the 2013 Term Loan, the 2013 Revolving Credit Facility, the 2013 Guarantee Facility, the 2013 December Senior Secured Notes, the New Revolving Credit Facilities, the New Senior Secured Notes and the New Term Loan.

“Senior Secured Notes Escrow Accounts” has the meaning ascribed to it under “*The Offering—Escrow of Proceeds; Special Mandatory Redemption*”.

“Senior Secured Notes Escrow Agent” refers to an affiliate of one of the Initial Purchasers, acting in its capacity as escrow agent under the Senior Secured Notes Escrow Agreement.

“Senior Secured Notes Escrow Agreement” has the meaning ascribed to it under “*The Offering—Escrow of Proceeds; Special Mandatory Redemption*”.

“Senior Secured Notes Guarantees” has the meaning ascribed to it under “*The Offering—Guarantees—Senior Secured Notes*”.

“Senior Secured Notes Guarantors” has the meaning ascribed to it under “*The Offering—Guarantees—Senior Secured Notes*”.

“Senior Secured Notes Issuer” refers to Altice Financing S.A., a public limited liability company (*société anonyme*) incorporated under the laws of Luxembourg.

“Senior Secured Notes Issuer Pledged Proceeds Notes” collectively refers to the Cool Proceeds Note, the 2012 Acquisition Note, the HOT Refinancing Notes, the 2013 June AH Proceeds Loan, the 2013 December AH Proceeds Loans and the New AH Proceeds Loans.

“SIRESP” means SIRESP—Gestão de Redes Digitais de Segurança e Emergência, S.A., a public limited liability company (*sociedade anónima*) incorporated under the laws of Portugal.

“SPV1” refers to H. Hadaros 2012 Ltd.

“Tricom” refers collectively to Tricom S.A., a corporation (*Sociedad Anónima*) incorporated under the laws of the Dominican Republic and Global Interlink Ltd.

“Tricom Acquisition” refers to the acquisition by Altice (through one of its Subsidiaries) of Tricom which was consummated on March 12, 2014.

“Trustee” refers to Deutsche Bank AG, London Branch.

“U.S. Exchange Act” refers to the U.S. Securities Exchange Act of 1934, as amended.

“U.S. Securities Act” refers to the U.S. Securities Act of 1933, as amended.

“Winreason” refers to Winreason—S.A., a public limited liability company (*sociedade anónima*) incorporated under the laws of Portugal.

PRESENTATION OF FINANCIAL AND OTHER INFORMATION

Unless otherwise stated or the context otherwise requires, references to “IFRS” herein are to IFRS as adopted in the European Union.

Financial Data

Issuers

The Senior Secured Notes Issuer and the Senior Notes Issuer were incorporated on August 17, 2012. The following financial statements of the Senior Secured Notes Issuer and the Senior Notes Issuer are incorporated by reference to Altice’s website (<http://www.altice.net/phoenix.zhtml?c=252690&p=irol-regulatoryinformation>):

- the financial statements of the Senior Secured Notes Issuer as of and for the year ended December 31, 2013, and as of December 31, 2012 and for the period from August 17, 2012 (its date of incorporation) to December 31, 2012, each prepared in accordance with IFRS, which have been audited by Deloitte Audit S.à r.l.; and
- the financial statements of the Senior Notes Issuer as of and for the year ended December 31, 2013, and as of December 31, 2012 and for the period from August 17, 2012 (its date of incorporation) to December 31, 2012, prepared in accordance with IFRS, which have been audited by Deloitte Audit S.à r.l.

Historical Consolidated Financial Information

These Listing Particulars includes the following historical consolidated financial statements of Altice International:

- the unaudited condensed consolidated financial statements of Altice International as of and for the three and nine month periods ended September 30, 2014 (including comparative information as of and for the three and nine month periods ended September 30, 2013), prepared in accordance with IAS 34 Interim Financial Reporting (“IAS 34”), which have been reviewed by Deloitte Audit S.à r.l.; and
- the audited consolidated financial statements of Altice International as of and for the years ended December 31, 2012 (including comparative information as of and for the year ended December 31, 2011) and 2013, prepared in accordance with IFRS, which have been audited by Deloitte Audit S.à r.l.

The above-mentioned historical consolidated financial information of Altice International, and information directly derived therefrom, are referred to herein as the “Historical Consolidated Financial Information”.

Illustrative Aggregated Selected Financial Information

Altice International is a holding company which, since its formation in 2008, has from time to time made significant equity investments in a number of cable, media and telecommunication businesses in various jurisdictions. The following is a summary of the key investments and disposals made by Altice International since 2011, which have had a significant impact on the Historical Consolidated Financial Information.

During the year ended December 31, 2011, Altice International made the following acquisitions that fundamentally changed the business undertaking: (i) in the first quarter of 2011, Altice International increased its ownership in HOT-Telecommunication Systems Ltd. (together with its subsidiaries but excluding HOT Mobile Ltd., the “HOT Telecom Group”) thereby acquiring a majority equity ownership in the HOT Telecom Group (as a result of which the financial information of the HOT Telecom Group is consolidated in the Historical Consolidated Financial Information of Altice International with effect from March 16, 2011). In addition, in the fourth quarter of 2011, MIRS Communications Ltd. (an Israeli mobile services provider that was subsequently renamed HOT Mobile Ltd.) was acquired by the HOT Telecom Group from a subsidiary of Altice International and renamed HOT Mobile Ltd (the HOT Telecom Group and HOT Mobile Ltd. are collectively referred to herein as the “HOT Group”); and (ii) in the second quarter of 2011, Altice International acquired a controlling equity interest in Coditel Brabant S.p.r.l, a company with cable television operations in Belgium and Coditel S.à r.l., a company with cable television operations in Luxembourg, in each case, through an intermediate holding company, Coditel Holding S.A. (the financial information of which is consolidated in the Historical Consolidated Financial Information of Altice International with effect from July 1, 2011). In addition, Altice International sold 5% of its equity interest in MIRS Communications Limited during the course of 2011.

The year ended December 31, 2012 was marked by the following two significant acquisitions by Altice International: (i) in the first quarter of 2012, Altice International acquired approximately 60% of the equity interests in Cabovisão, a

Portuguese telecommunications company (the financial information of which is consolidated in the Historical Consolidated Financial Information of Altice International with effect from February 29, 2012); and (ii) in the fourth quarter of 2012, the Company completed the take-private transaction of the HOT Group whereby it acquired substantially all of the equity interests in HOT-Telecommunication Systems Ltd. it did not previously own.

Altice International added to its portfolio of holdings in 2013 with the following acquisitions: (i) in the first quarter of 2013, Altice International acquired substantially all of the equity interests in Cabovisão that it did not already own; (ii) in the third quarter of 2013, Altice International acquired a controlling equity interest in Groupe Outremer Telecom, a telecommunications company with operations in the French Overseas Territories (the financial information of which is consolidated in the Historical Consolidated Financial Information of Altice International with effect from July 5, 2013); and (iii) in the third quarter of 2013, Altice International (through its subsidiary Cabovisão) acquired 100% of the equity interests in Winreason, the owner of the Portuguese telecommunications holding company ONI S.G.P.S. and its subsidiaries (the financial information of which is consolidated in the Historical Consolidated Financial Information of Altice International with effect from August 8, 2013) and (iv) in November 2013, Altice International acquired further equity interests in Coditel pursuant to the 2013 Coditel Acquisition. In addition, in 2013, we disposed of our interests in Valvision S.A.S. (“Valvision”) and acquired Ma Chaîne Sport S.A.S. (“Ma Chaîne Sport”) and SportV S.A. (“SportV”). During 2013 Altice International also initiated its equity investment in Wananchi (“Wananchi”), a Kenyan cable operator.

In 2014, Altice International consummated the acquisitions of (i) Tricom, a cable, fixed-line and mobile services provider in the Dominican Republic (the financial information of which is consolidated in the Historical Consolidated Financial Information of Altice International with effect from March 12, 2014), (ii) ODO, a mobile and wireless broadband services provider in the Dominican Republic (the financial information of which is consolidated in the Historical Consolidated Financial Information of Altice International with effect from April 9, 2014) and (iii) Mobius, a telecommunications operator in the French Overseas Territory of La Réunion (the financial information of which is consolidated in the Historical Consolidated Financial Information of Altice International with effect from January 1, 2014). On March 11, 2014, we entered into arrangements pursuant to which Altice Caribbean, acquired a substantial proportion of the minority interests in Altice Blue Two (which owns 96% of Outremer, the remaining interest being owned by Altice S.A.) in exchange for ordinary shares of Altice S.A. and Altice-Caribbean Warrants. On December 9, 2014, we entered into an agreement with Oi S.A. to purchase 100% of the issued share capital of PT Portugal. In addition, in connection with the acquisition of SFR by Numericable Group (which is indirectly controlled by our parent Altice S.A., and therefore an affiliate of the Group), we have entered into a commitment agreement with the French Competition Authority to dispose of our mobile network assets in Mayotte and La Réunion (which are part of our Group’s business in the French Overseas Territories and which in aggregate contributed €10 million to aggregated and pro forma EBITDA for the fiscal year ended 2013.). If this disposal is not completed by mid-2015, we are committed to appoint an independent agent (who must be approved by the French Competition Authority) to complete such disposal. Further, we have undertaken to ensure that such mobile assets in La Réunion and in Mayotte are managed independently from the other activities of Numericable Group (including those of SFR) prior to such disposal. We expect that the disposal of the mobile network assets of OMT in Mayotte and La Réunion will reduce the overall leverage of the Group.

As a result of the series of significant acquisitions that have been consummated by Altice International since 2011, and the intra-year timing of such acquisitions, the Historical Consolidated Financial Information does not consolidate the results of operations of the entire business undertaking of the Group as it existed as of December 31, 2011, 2012, 2013 or September 30, 2013 or 2014 for all of the periods presented and the comparability of the Historical Consolidated Financial Information over each of the periods presented may be significantly limited. Consequently, in addition to the Pro Forma Financial Information (as defined herein) described below, certain unaudited illustrative aggregated selected financial information as of and for each of the years ended December 31, 2011 and 2012 has been included in these Listing Particulars as we believe this will aid comparability of the results of operations of the Group for each of these periods. The illustrative aggregated selected financial information for each of the years ended December 31, 2011 and 2012, and information directly derived therefrom, are referred to herein as the “Illustrative Aggregated Selected Financial Information”. The Illustrative Aggregated Selected Financial Information has been compiled by aggregating selected aggregated financial information extracted from (i) the audited Historical Consolidated Financial Information of Altice International for each of the years ended December 31, 2011 and 2012 and (ii) the historical financial information of each of the business undertakings the acquisition of which were consummated by Altice International prior to December 31, 2013 for each of the years ended December 31, 2011 and 2012 (or for such shorter periods during the years ended December 31, 2011 and 2012, as applicable, for which the results of operations of such acquired business undertaking are not included in the audited Historical Consolidated Financial Information of Altice International). Adjustments have been made to the resulting aggregation in instances where the audited historical financial information of a business undertaking acquired by Altice International and included within such resulting aggregation have been drawn up in accordance with an accounting framework, the measurement and recognition criteria of which differs substantially from the corresponding criteria applicable under IFRS as adopted by the European Union. The Illustrative Aggregated Selected Financial Information does not include any additional pro forma adjustments. For further details regarding the basis of preparation of the Illustrative Aggregated Selected Financial Information, please see Note 1 to the Illustrative

Aggregated Selected Financial Information included elsewhere in these Listing Particulars. The Illustrative Aggregated Selected Financial Information does not aggregate the financial information of the Mobius Group, ODO, Tricom or PT Portugal. The Pro Forma Financial Information (as defined below) and the Illustrative Aggregated Selected Financial Information include the results of operations of Valvision until June 6, 2013 even though we disposed of our interests in Valvision in 2013. Valvision's contribution to our revenue and EBITDA was not material. Further, the Historical Consolidated Financial Information, the Illustrative Aggregated Selected Financial Information and the Pro Forma Financial Information include the results of operations of Green Datacenter and Auberimmo S.A.S. ("Auberimmo"), which are subsidiaries of Altice International but are unrestricted subsidiaries under the terms governing our existing indebtedness and did not constitute Restricted Subsidiaries on the Issue Date. In each of the years ended December 31, 2011, 2012 and 2013, Green Datacenter contributed €4.3 million, €10.3 million and €12.4 million to aggregated and pro forma revenues and €3.6 million, €9.0 million and €10.2 million to aggregated and pro forma EBITDA and Auberimmo's contribution to our revenue and EBITDA was not material. For the nine months ended September 30, 2013 and 2014, Green Datacenter contributed €8.8 million and €8.2 million to pro forma revenue and €7.6 million and €6.9 million to pro forma EBITDA, respectively. As of September 30, 2014, Green Datacenter had €34.8 million of third-party debt outstanding.

The Illustrative Aggregated Selected Financial Information was prepared on the basis of the audited historical financial statements of Altice International for the years ended December 31, 2011 and 2012 prepared in accordance with IFRS (which include in the notes thereto certain pro forma financial information of HOT Telecom for the period between January 1, 2011 and March 16, 2011) included elsewhere in these Listing Particulars and the following additional financial statements that are incorporated by reference to Altice's website (www.altice.net/phoenix.zhtml?c=252690&p=irol-ipo):

- the audited financial statements of Coditel Brabant S.p.r.l. as of and for the seven months ended July 31, 2011 prepared in accordance with Belgian GAAP;
- the audited accounts of Coditel S.à r.l. for the period from January 1, 2011 to July 31, 2011 prepared in accordance with Luxembourg GAAP;
- the unaudited financial statements of Cabovisão for the two months ended February 29, 2012 prepared in accordance with IFRS;
- the audited financial statements of Cabovisão for the year ended December 31, 2011 prepared in accordance with IFRS;
- the audited pro forma accounts for ONI for the years ended December 31, 2011 and 2012 (corresponding to the period between January 1 and December 31) prepared in accordance with IFRS;
- the audited consolidated financial statements for Groupe Outremer Telecom for the years ended December 31, 2011 and 2012 prepared in accordance with IFRS; and
- the audited statutory accounts of Ma Chaîne Sport for the years ended December 31, 2011 and 2012 prepared in accordance with French GAAP (aligned with the measurement and recognition criteria of IFRS).

The Illustrative Aggregated Selected Financial Information among other things:

- neither represents financial information prepared in accordance with IFRS nor pro forma financial information and should not be read as such;
- has not been audited in accordance with any generally accepted auditing standards;
- has not been reviewed in accordance with any generally accepted review standards;
- is presented for illustrative purposes only; and
- is provided for certain limited items from Altice International's statement of income and statement of cash flows and accordingly does not include all the information that would usually be included in a statement of income or statement of cash flows or any information that would usually be included in a statement of other comprehensive income, statement of financial position or statement of changes in equity, in each case prepared in accordance with IFRS.

- does not purport to represent what our actual results of operations or financial condition would have been had the significant acquisitions and disposals described above occurred with effect from the dates indicated; and
- does not purport to project our results of operations or financial condition for any future period or as of any future date.

The Illustrative Aggregated Selected Financial Information included in these Listing Particulars has not been prepared in accordance with the requirements of Regulation S-X of the U.S. Securities Act, the EU Prospectus Directive, or any generally accepted accounting standards. Neither the assumptions underlying the adjustments nor the resulting aggregated financial information have been audited or reviewed in accordance with any generally accepted auditing standards. The Illustrative Aggregated Selected Financial Information has been prepared only for the years ended December 31, 2011 and 2012 and no similar financial information has been prepared by Altice International for any other periods for which Historical Consolidated Financial Information or Pro Forma Financial Information has been included in these Listing Particulars.

The Illustrative Aggregated Selected Financial Information includes results of operations data of the acquired businesses (other than Mobius Group, Tricom, ODO and PT Portugal) for each of the periods presented even though we may not have owned or controlled such acquired businesses for all or any of the duration of the periods presented and would not have been permitted under IFRS to consolidate the results of such acquired businesses in any historical financial statements. As we currently have the ability to control Coditel Holding through which we conduct our operations in Belgium and Luxembourg, we consolidate 100% of their revenue and expenses in the Illustrative Aggregated Selected Financial Information for each of the periods presented, and in the Historical Consolidated Financial Information from July 1, 2011, respectively, despite the fact that third parties own significant interests in these entities. Since we do not present any Illustrative Aggregated Selected Financial Information below the line item operating income before depreciation, amortization, restructuring costs and other expenses, or EBITDA, the non-controlling interests in the operating results of Coditel Holding are not reflected anywhere in the Illustrative Aggregated Selected Financial Information. Such non-controlling owners' interests may be very significant. Since we do not present any Illustrative Aggregated Selected Financial Information below the line item operating income before depreciation, amortization, restructuring costs and other expenses, or EBITDA, the Illustrative Aggregated Selected Financial Information is also subject to the limitations with respect to non-IFRS measures described below.

ODO Financial Information

As of September 30, 2014, the Group owns approximately 97.2% of the equity interests in ODO. These Listing Particulars includes the audited stand-alone financial statements of ODO as of and for the years ended December 31, 2013 and 2012 and as of and for the nine months ended September 30, 2013. The financial information of ODO has been consolidated in the Historical Consolidated Financial Information of Altice International with effect from April 9, 2014. Certain financial information of ODO for the nine months ended September 30, 2014 presented in these Listing Particulars for comparative purposes have been derived from the Historical Consolidated Financial Information of Altice International as of and for the nine months ended September 30, 2014 (including the notes thereto, which contain certain financial information of ODO for the period between January 1, 2014 and April 8, 2014).

PT Portugal Financial Information

Historically, the results of the former Portugal Telecom group were consolidated at the level of Portugal Telecom, SGPS, S.A., which was the holding entity and the listed company for such group and which consolidated the results of the PT Portugal Group as well as the results of certain entities that are not a part of the PT Portugal Group and that will not be acquired pursuant to the PT Portugal Acquisition. These Listing Particulars includes the audited stand alone financial statements prepared under Portuguese GAAP of PTC and Meo, S.A, which are the most significant subsidiaries of the PT Portugal Group, as of and for the years ended December 31, 2012 (including unaudited comparative information as of and for the year ended December 31, 2011) and 2013 and the unaudited condensed financial information of PTC and Meo, S.A. as of and for the nine months ended September 30, 2013 and 2014 (the "PT Historical Financial Information"). The PT Historical Financial Information does not consolidate the results of operations of the entire business undertaking of the PT Portugal Group as it existed as of December 31, 2011, 2012 or 2013 or September 30, 2013 or 2014 for all of the periods presented. Consequently, in addition to the PT Historical Financial Information and the Pro Forma Financial Information described below, certain unaudited illustrative aggregated selected financial information of the PT Portugal Group for each of the years ended December 31, 2011, 2012 and 2013 and for each of the nine months ended September 30, 2013 and 2014 has been included in these Listing Particulars. The illustrative aggregated selected financial information of the PT Portugal Group for each of the years ended December 31, 2011, 2012 and 2013, and the nine months ended September 30, 2013 and 2014, and information directly derived therefrom, are referred to herein as the "PT Portugal Combined Selected Financial Information". The PT Portugal Combined Selected Financial Information has been compiled by aggregating selected aggregated financial information extracted from (i) the audited historical stand alone financial statements of PTC and Meo, S.A. for each of the years

ended December 31, 2012 (including unaudited comparative figures for 2011) and 2013 and the unaudited historical condensed financial statements for each of the nine months ended September 30, 2013 and 2014 and (ii) the unaudited historical condensed financial information of the other subsidiaries and assets included in the PT Portugal Group derived from the internal financial reporting systems of the PT Portugal Group. The PT Portugal Combined Selected Financial Information is subject to significant limitations similar to those described under “—*Illustrative Aggregated Selected Financial Information*” above and under “—*Non-IFRS Measures*” below. For the nine months ended September 30, 2014, PTC and Meo, S.A. represented over 97% of the PT Portugal Group’s revenues as derived from the PT Portugal Combined Selected Financial Information described below.

Pro Forma Financial Information

The Listing Particulars includes the (i) unaudited pro forma consolidated interim financial statements of Altice International as of and for each of the nine-months periods ended September 30, 2013 and 2014 and (ii) the unaudited pro forma consolidated financial statements of Altice International for the year ended December 31, 2013, giving effect to each of the significant acquisitions described above as if such acquisitions had occurred by January 1, 2013, January 1, 2014 or September 30, 2014, as the case may be (but without giving effect to the disposal of our mobile network assets in Mayotte and La Réunion which we have committed to undertake and, except as described below without giving effect to the Tricom Acquisition or the Mobius Acquisition) (collectively, the “Pro Forma Financial Information”). These Listing Particulars includes certain information derived from the Pro Forma Financial Information (a) after giving effect to each of the significant acquisitions described above but without giving effect to the ODO Acquisition, the Tricom Acquisition, the Mobius Acquisition or the PT Portugal Acquisition (the “Pre-PT/ODO Transactions Pro Forma Financial Information”), (b) after giving effect to each of the significant acquisitions described above (including the ODO Acquisition, but without giving effect to the PT Portugal Acquisition, Tricom Acquisition or the Mobius Transaction) (the “Pre-PT Transaction Pro Forma Financial Information”) and (c) after giving effect to each of the significant acquisitions described above (including the ODO Acquisition and the PT Portugal Acquisition, but without giving effect to the Tricom Acquisition or the Mobius Transaction) (the “Post Transaction Pro Forma Financial Information”).

The financial information of Tricom has been consolidated in the Historical Consolidated Financial Information of Altice International with effect from March 12, 2014 and the financial information of Mobius has been consolidated in the Historical Consolidated Financial Information of Altice International with effect from January 1, 2014. As a result, the Pro Forma Financial Information also consolidates the financial information of Tricom and Mobius from March 12, 2014 and January 1, 2014, respectively, but does not give pro forma effect to the Mobius Acquisition or the Tricom Acquisition for any other periods. For the nine months ended September 30, 2014, Tricom contributed €82.0 million to pro forma revenue and €40.5 million to pro forma EBITDA and Mobius contributed €13.2 million to pro forma revenue and €3.1 million to pro forma EBITDA.

With effect from April 9, 2014, the financial information of ODO has been consolidated in the Historical Consolidated Financial Information of Altice International. The Pre-PT/ODO Transactions Pro Forma Financial Information as of and for the nine months ended September 30, 2014 deducts the contribution of ODO and does not give pro forma effect to the ODO Acquisition during this period. The Post-Transaction Pro Forma Financial Information as of and for the nine months ended September 30, 2014, includes ODO’s contribution for the period between April 9, 2014, and September 30, 2014, and gives pro forma effect to the ODO Acquisition for the period between January 1, 2014, and April 8, 2014. See Note 2 to the Pro Forma Financial Information included elsewhere in these Listing Particulars.

The Pro Forma Financial Information included in these Listing Particulars has not been prepared in accordance with the requirements of Regulation S-X of the U.S. Securities Act, the EU Prospectus Directive or any generally accepted accounting standards.

The Pro Forma Financial Information included in these Listing Particulars and their respective pro forma adjustments, among other things:

- are limited to certain income statement and balance sheet items;
- are based on available information and assumptions that we believe are reasonable under the circumstances;
- are presented for informational purposes only;
- have not been audited in accordance with any generally accepted auditing standards;
- have not been reviewed in accordance with any generally accepted review standards;
- do not purport to represent what our actual results of operations or financial condition would have been had the applicable significant acquisitions described above occurred with effect from the dates indicated; and

- do not purport to project our results of operations or financial condition for any future period or as of any future date.

The Historical Consolidated Financial Information, the Pro Forma Financial Information and the Illustrative Aggregated Selected Financial Information mentioned above do not indicate results that may be expected for any future period.

The Pro Forma Financial Information includes the results of operations and financial condition of the acquired businesses and in the case of the Post-Transaction Pro Forma Financial Information, the results of ODO and PT Portugal, for each of the periods presented even though we may not have owned or controlled such acquired businesses for all or any of the duration of the periods presented and would not have been permitted under IFRS to consolidate the results of such acquired businesses in any historical financial statements.

Certain Adjusted Financial Information

These Listing Particulars also includes certain financial information on an as adjusted basis to give effect to the New Transactions, including this offering and the application of the proceeds therefrom, including combined financial data as adjusted to reflect the effect of the New Transactions on the Group's indebtedness as if the New Transactions had occurred on September 30, 2014 and the Group's finance costs as if the New Transactions occurred on January 1, 2013 or January 1, 2014, as applicable. The as adjusted financial information has been prepared for illustrative purposes only and does not represent what the Group's indebtedness would have been had the New Transactions occurred on such dates; nor does it purport to project the combined entities' or the Group's indebtedness or interest expense at any future date. The as adjusted financial information has not been prepared in accordance with IFRS. Neither the assumptions underlying the adjustments nor the resulting as adjusted financial information have been audited or reviewed in accordance with any generally accepted auditing standards.

Non-IFRS Measures

These Listing Particulars contains measures and ratios (the "Non-IFRS Measures"), including, for example, EBITDA, Adjusted EBITDA, Pro Forma Adjusted EBITDA (including synergies) and cash flow conversion, that are not required by, or presented in accordance with, IFRS or any other generally accepted accounting standards. We present Non-IFRS measures because we believe that they are of interest for the investors and similar measures are widely used by certain investors, securities analysts and other interested parties as supplemental measures of performance and liquidity. The Non-IFRS measures may not be comparable to similarly titled measures of other companies, have limitations as analytical tools and should not be considered in isolation or as a substitute for analysis of our, or any of our subsidiaries', operating results as reported under IFRS or other generally accepted accounting standards. The Non-IFRS measures may also be defined differently than the corresponding terms governing our indebtedness, including the Existing Indentures and the New Indentures. Non-IFRS measures and ratios such as EBITDA and Adjusted EBITDA are not measurements of our, PT Portugal's or any of our or their subsidiaries', performance or liquidity under IFRS or any other generally accepted accounting principles. In particular, you should not consider EBITDA or Adjusted EBITDA as an alternative to (a) operating profit or profit for the period (as determined in accordance with IFRS) as a measure of our, or any of our operating entities' or PT Portugal's or any of their subsidiaries, operating performance, (b) cash flows from operating, investing and financing activities as a measure of our, PT Portugal's or any of our or their subsidiaries' ability to meet its cash needs or (c) any other measures of performance under IFRS or other generally accepted accounting standards. EBITDA and Adjusted EBITDA have limitations as an analytical tool, and you should not consider them in isolation, or as a substitute for, an analysis of the results of our operating entities as reported under IFRS or other generally accepted accounting standards. Some of these limitations are:

- they do not reflect cash expenditures or future requirements for capital expenditures or contractual commitments;
- they do not reflect changes in, or cash requirements for, working capital needs;
- they do not reflect the significant interest expense or the cash requirements necessary to service interest or principal payments;
- although depreciation, amortization and impairment are non-cash charges, the assets being depreciated and amortized will generally need to be replaced in the future and EBITDA and Adjusted EBITDA do not reflect any cash requirements that would be required for such replacements; and
- some of the exceptional items that we or our operating entities eliminate in calculating EBITDA and Adjusted EBITDA reflect cash payments that were made, or will in the future be made.

These Listing Particulars contains certain synergy estimates, among others, relating to cost reductions and other benefits expected to arise from the Tricom Acquisition, the ODO Acquisition and the PT Portugal Acquisition as well as related costs to implement such measures. The estimates present the expected future impact of these transactions and the

integration of Tricom, ODO and PT Portugal into our existing business. Such estimates are based on a number of assumptions made in reliance on the information available to us and management's judgments based on such information. The assumptions used in estimating the synergies arising from the Tricom Acquisition, the ODO Acquisition and the PT Portugal Acquisition are inherently uncertain and are subject to a wide variety of significant business, economic, and competitive risks and uncertainties that could cause actual results to differ materially from those contained in the synergy benefit estimates.

In these Listing Particulars, "Adjusted EBITDA" as presented by Altice S.A. and Altice International corresponds to "EBITDA" as reported by such entities for financial reporting purposes as of September 30, 2014.

Certain amounts and percentages presented herein have been rounded and, accordingly, the sum of amounts presented may not equal the total. All references in this document to NIS and ILS refer to New Israeli Shekels and all references to "U.S. \$" or "\$" are to U.S. dollars. All references to DOP refer to the Dominican Peso. All references to "€" are to euro.

SUBSCRIBER, MARKET AND INDUSTRY DATA

Key Operating Measures

These Listing Particulars includes information relating to certain key operating measures of certain subsidiaries in the Group, including, among others, number of homes passed, Cable Customer Relationships, subscribers, RGUs, RGUs per Cable Customer Relationship, churn, ARPUs, penetration and mobile coverage of territory, as applicable, which our management uses or will use to track the financial and operating performance of our businesses. None of these terms are measures of financial performance under IFRS, nor have these measures been audited or reviewed by an auditor, consultant or expert. All of these measures are derived from the internal operating systems of the individual members of the Group, PTC, Meo, S.A. and PT Portugal, as the case may be. As defined by the Group, PTC, Meo, S.A. or PT Portugal, these terms may not be directly comparable to corresponding or similar terms used by competitors or other companies. Certain measures relating to PTC and Meo, S.A. have been derived from the information included in the public filings of Portugal Telecom, SGPS, S.A. Please refer to the meanings of these terms as defined elsewhere in these Listing Particulars.

Market and Industry Data

We operate in industries in which it is difficult to obtain precise market and industry information. We have generally obtained the market and competitive position data in these Listing Particulars from our competitors' public filings, from industry publications and from surveys or studies conducted by third party sources that we believe to be reliable. Certain information in these Listing Particulars contains independent market research carried out by Euromonitor International Limited, Ovum Research, Anacom, IDC, Cisco, and Analysys Mason and should not be relied upon in making, or refraining from making, any investment decision. Analysys Mason does not guarantee the accuracy, adequacy or completeness of any information and would not be responsible for any errors or omissions or for the results obtained from the use of such information.

With respect to Israel, we calculate market share for each of our services by dividing the number of RGUs for such service by the total number of subscribers in Israel to such service, which is calculated based on our competitors' public filings and reported subscriber base, other public information and our internal estimates. Under HOT's mobile license, it is required to calculate market share of its mobile operations, which is calculated using different parameters than as described above. For more information see "*Description of Our Business—Material Contracts—Provision of certain bank guarantees to the State of Israel relating to performance of certain license terms*". In footprint market shares in the jurisdictions in which we operate are calculated from our penetration data by extrapolating overall market penetration from industry sources to our footprint. Market and industry data relating to PT Portugal have been derived from public filings made by Portugal Telecom SGPS, S.A.

However, neither we nor the Initial Purchasers or any of our or their respective advisors can verify the accuracy and completeness of such information and neither we nor the Initial Purchasers or any of our or their respective advisors has independently verified such market and position data. We do, however, accept responsibility for the correct reproduction of this information and, as far as we are aware and are able to ascertain from information published, no facts have been omitted that would render the reproduced information inaccurate or misleading.

In addition, in many cases we have made statements in these Listing Particulars regarding our industries and our position in these industries based on our experience and our own investigation of market conditions. Neither we nor the Initial Purchasers or any of our or their respective advisors can assure you that any of these assumptions are accurate or correctly reflect our position in these industries, and none of our or their internal surveys or information has been verified by independent sources.

EXCHANGE RATE INFORMATION

We have set forth in the table below, for the periods and dates indicated, certain information regarding the exchange rates between U.S. dollars and euro based on the market rates at 6:00 p.m. London time. We have provided this exchange rate information solely for your convenience. We do not make any representation that any amount of currencies specified in the table below has been, or could be, converted into the applicable currency at the rates indicated or any other rate.

	U.S.\$ per euro			
	Period Average ⁽¹⁾⁽²⁾	High	Low	Period End ⁽³⁾
Year				
2011	1.3924	1.4874	1.2925	1.2960
2012	1.2859	1.3463	1.2053	1.3197
2013	1.3300	1.3789	1.2819	1.3789
2014	1.3285	1.3925	1.2100	1.2100
Month				
September 2013	1.3354	1.3531	1.3127	1.3531
October 2013	1.3639	1.3804	1.3498	1.3599
November 2013	1.3497	1.3367	1.3605	1.3591
December 2013	1.3706	1.3803	1.3551	1.3789
January 2014	1.3620	1.3789	1.3505	1.3505
February 2014	1.3662	1.3802	1.3505	1.3802
March 2014	1.3830	1.3721	1.3733	1.3772
April 2014	1.3810	1.3887	1.3705	1.3866
May 2014	1.3731	1.3925	1.3592	1.3641
June 2014	1.3596	1.3690	1.3531	1.3690
July 2014	1.3535	1.3691	1.3379	1.3385
August 2014	1.3315	1.3431	1.3145	1.3145
September 2014	1.2899	1.3141	1.2629	1.2629
October 2014	1.2677	1.2825	1.2513	1.2531
November 2014	1.2471	1.2550	1.2388	1.2435
December 2014	1.2312	1.2509	1.2100	1.2100
January 2015 (through January 26, 2015)	1.1702	1.2099	1.1255	1.1280

(1) The average rate for a year means the average of the Bloomberg Composite Rates on the last day of each month during a year.

(2) The average rate for each month presented is based on the average Bloomberg Composite Rate for each business day of such month.

(3) Represents the exchange rate on the last business day of the applicable period.

For your convenience we have translated certain financial information and operating measures expressed in Swiss Francs, NIS or Dominican Peso, as applicable, into euro. We have provided this exchange rate information solely for your convenience. We do not make any representation that any amount of currencies specified in the table below has been, or could be, converted into the applicable currency at the rates indicated or any other rate. The exchange rates used herein are set forth below and reflect the periods for which we have presented financial information and operating measures that we have translated into euros, from Swiss Francs, NIS or Dominican Peso, as applicable.

As of	EUR per NIS	
December 31, 2011	€0.2024	NIS1.00
December 31, 2012	€0.2030	NIS1.00
December 31, 2013	€0.2093	NIS1.00
September 30, 2013	€0.2094	NIS1.00
September 30, 2014	€0.2150	NIS1.00

Average rate for the	EUR per NIS	
Year ended December 31, 2011	€0.2009	NIS1.00
Year ended December 31, 2012	€0.2018	NIS1.00
Year ended December 31, 2013	€0.2086	NIS1.00
Nine months ended September 30, 2013	€0.2086	NIS1.00
Nine months ended September 30, 2014	€0.2113	NIS1.00

As of	EUR per CHF	
December 31, 2011	€0.8226	CHF1.00
December 31, 2012	€0.8226	CHF1.00

December 31, 2013.....	€0.8161	CHF1.00
September 30, 2013.....	€0.8179	CHF1.00
September 30, 2014.....	€0.8294	CHF1.00

Average rate for the	EUR per CHF	
Year ended December 31, 2011.....	€0.8112	CHF1.00
Year ended December 31, 2012.....	€0.8296	CHF1.00
Year ended December 31, 2013.....	€0.8126	CHF1.00
Nine months ended September 30, 2013.....	€0.8119	CHF1.00
Nine months ended September 30, 2014.....	€0.8211	CHF1.00

As of	EUR per DOP	
December 31, 2013.....	€0.0168	DOP1.00
September 30, 2014.....	€0.0173	DOP1.00

Average rate for the	EUR per DOP	
Year ended December 31, 2012.....	€0.0201	DOP1.00
Year ended December 31, 2013.....	€0.0183	DOP1.00
Nine months ended September 30, 2013.....	€0.0186	DOP1.00
Nine months ended September 30, 2014.....	€0.0172	DOP1.00

FORWARD-LOOKING STATEMENTS

These Listing Particulars contains “forward-looking statements” as that term is defined by the U.S. federal securities laws. These forward-looking statements include, but are not limited to, statements other than statements of historical facts contained in these Listing Particulars, including, but without limitation, those regarding our or PT Portugal’s future financial condition, results of operations and business, our or PT Portugal’s products, acquisitions, dispositions and finance strategies, our or PT Portugal’s capital expenditure priorities, regulatory or technological developments in the market, subscriber growth and retention rates, potential synergies and cost savings, competitive and economic factors, the maturity of our or PT Portugal’s markets, anticipated cost increases, synergies, liquidity, credit risk and target leverage levels. In some cases, you can identify these statements by terminology such as “aim”, “anticipate”, “believe”, “continue”, “could”, “estimate”, “expect”, “forecast”, “guidance”, “intend”, “may”, “plan”, “potential”, “predict”, “project”, “should”, and “will” and similar words used in these Listing Particulars.

By their nature, forward-looking statements are subject to numerous assumptions, risks and uncertainties. Many of these assumptions, risks and uncertainties are beyond our control. Accordingly, actual results may differ materially from those expressed or implied by the forward-looking statements. Such forward-looking statements are based on numerous assumptions regarding our present and future business strategies and the environment in which we and PT Portugal operate. We caution readers not to place undue reliance on the statements, which speak only as of the date of these Listing Particulars, and we expressly disclaim any obligation or undertaking to disseminate any updates or revisions to any forward looking statement contained herein, to reflect any change in our expectations with regard thereto, or any other change in events, conditions or circumstances on which any such statement is based.

Where, in any forward-looking statement, we express an expectation or belief as to future results or events, such expectation or belief is expressed in good faith and believed to have a reasonable basis, but there can be no assurance that the expectation or belief will result or be achieved or accomplished.

Risks and uncertainties that could cause actual results to vary materially from those anticipated in the forward-looking statements included in these Listing Particulars include those described under “Risk Factors”.

The following are some but not all of the factors that could cause actual results or events to differ materially from anticipated results or events:

- our substantial leverage and debt service obligations;
- our ability to generate sufficient cash flow to service our debt and to control and finance our capital expenditures and operations;
- restrictions and limitations contained in the agreements governing our debt;
- our ability to raise additional financing or refinance our existing indebtedness;
- fluctuations in currency exchange rates, inflation and interest rates;
- negative changes to our credit rating;
- risks associated with our structure, this offering, and our other indebtedness;
- the competitive environment and downward price pressure in the broadband internet communications, television sector, fixed line telephony, mobile telephony and B2B sectors in the countries in which we operate;
- economic and business conditions and trends in the industries in which we and the entities in which we have interests operate;
- changes in the political, judicial, economic or security environment in the countries in which we operate or will operate in the future;
- changes in consumer demand for cable-based and mobile products as well as the demand for bundled services and offerings;
- capital spending for the acquisition and/or development of telecommunications networks and services and equipment and competitor responses to our products and services, and the products and services of the entities in which we have interests;

- increases in operating costs and inflation risks;
- our ability to introduce new technologies or services and our ability to respond to technological developments;
- deployment of fiber or VDSL2 networks by competitors;
- perceived or actual health risks and other environmental requirements relating to our mobile operations;
- our ability to maintain favorable roaming or network sharing agreements;
- our ability to achieve cost saving from network sharing arrangements for our mobile services in Israel;
- reduced interconnection rates in the countries in which we operate, including Portugal;
- the ability of third party suppliers and vendors to timely deliver products, network infrastructure, equipment, software and services;
- the availability of attractive programming for our analog and digital video services or necessary equipment at reasonable costs;
- risks related to royalties payments and our licenses;
- technical failures, equipment defects, physical or electronic break-ins to the services, computer viruses and similar description problems;
- any negative impact on our reputation, including due to product quality issues;
- our ability to attract and retain customers;
- our ability to integrate acquired businesses and realize planned synergy benefits from past or future acquisitions (including, without limitation, PT Portugal following the PT Portugal Acquisition);
- uncertainty with respect to the amount and the timeframe for synergies and other benefits expected to arise from the PT Portugal Acquisition, the Tricom Acquisition, Mobius Acquisition, the ODO Acquisition and the cost savings we expect to realize from our Network Sharing Agreement in Israel;
- our ability to maintain adequate managerial controls and procedures as the business grows;
- our inability to provide high levels of customer service;
- the declining revenue from certain of our services and our ability to offset such declines;
- any disruptions in the credit and equity markets which could affect our credit instruments and cash investments;
- our ability to protect our intellectual property rights and avoid any infringement of any third party's intellectual property rights;
- our ability to maintain subscriber data and comply with data privacy laws;
- the outcome of any pending or threatened litigation, including class action lawsuits in Israel and antitrust proceedings in Portugal;
- uncertainty over the legal framework within which we own and operate our networks, including in Belgium and Luxembourg;
- post retirement and healthcare benefit obligations (both funded and unfunded) of companies we have acquired or may acquire in the future, including PT Portugal;
- changes in laws or treaties relating to taxation in the countries in which we operate, or the interpretation thereof;
- the regulatory environment in the countries in which we operate and changes in, or a failure or an inability to comply with, government regulations and adverse outcomes from regulatory proceedings;

- the application of law generally and government intervention that opens our fixed-line and mobile networks to competitors, which may have the effect of increasing competition and reducing our ability to reach the expected returns on investment;
- our ability to manage our brands;
- our inability to completely control the prices we charge to customers or the programming we provide;
- our ability to obtain building and environmental permits for the building and upgrading of our networks, including our mobile network in Israel, and to comply generally with city planning laws;
- the loss of key employees and the availability of qualified personnel and a deterioration of the relationship with employee representatives;
- our ultimate parent's interest may conflict with our interests;
- the entry of new operators into the telecommunications markets in which we operate;
- risks related to the Transactions and our ability to execute the Transactions in the manner and within the timetable currently envisaged;
- events that are outside of our control, such as political unrest in international markets, terrorist attacks, natural disasters, pandemics and other similar events; and
- other factors discussed in these Listing Particulars.

The cable television, broadband internet access, fixed-line telephony, ISP services, mobile services and B2B industries are changing rapidly and, therefore, the forward-looking statements of expectations, plans and intent in these Listing Particulars are subject to a significant degree of risk. These forward-looking statements and such risks, uncertainties and other factors speak only as of the date of these Listing Particulars, and we expressly disclaim any obligation or undertaking to disseminate any updates or revisions to any forward looking statement contained herein, to reflect any change in our expectations with regard thereto, or any other change in events, conditions or circumstances on which any such statement is based. Readers are cautioned not to place undue reliance on any forward looking statement.

The cautionary statements set forth above should be considered in connection with any subsequent written or oral forward-looking statements that we or persons acting on our behalf may issue. We do not undertake any obligation to review or confirm analysts' expectations or estimates or to release publicly any revisions to any forward-looking statements to reflect events or circumstances after the date of these Listing Particulars.

We disclose important factors that could cause our actual results to differ materially from our expectations in these Listing Particulars. These cautionary statements qualify all forward-looking statements attributable to us or persons acting on our behalf. When we indicate that an event, condition or circumstance could or would have an adverse effect on us, we mean to include effects upon our business, financial and other conditions, results of operations and ability to make payments under the New Notes.

These Listing Particulars contains certain synergy estimates, among others, relating to cost reductions and other benefits expected to arise from the Tricom Acquisition, the ODO Acquisition and the PT Portugal Acquisition as well as related costs to implement such measures. The estimates present the expected future impact of these transactions and the integration of Tricom, ODO and PT Portugal into our existing business. Such estimates are based on a number of assumptions made in reliance on the information available to us and management's judgments based on such information. The assumptions used in estimating the synergies arising from the Tricom Acquisition, the ODO Acquisition and the PT Portugal Acquisition are inherently uncertain and are subject to a wide variety of significant business, economic, and competitive risks and uncertainties that could cause actual results to differ materially from those contained in the synergy benefit estimates.

AVAILABLE INFORMATION

For so long as any of the New Notes are “restricted securities” within the meaning of Rule 144A(a)(3) under the U.S. Securities Act, we will, during any period in which we are neither subject to the reporting requirements of Section 13 or 15(d) of the U.S. Exchange Act, nor exempt from the reporting requirements of the U.S. Exchange Act under Rule 12g3-2(b) thereunder, provide to the holder or beneficial owner of such restricted securities or to any prospective purchaser of such restricted securities designated by such holder or beneficial owner, in each case upon the written request of such holder, beneficial owner or prospective purchaser, the information required to be provided by Rule 144A(d)(4) under the U.S. Securities Act.

We are not currently subject to the periodic reporting and other information requirements of the U.S. Exchange Act. However, pursuant to the New Indentures and so long as the New Notes are outstanding, we will furnish periodic information to holders of the New Notes, as applicable. See “*Description of Senior Secured Notes—Certain Covenants—Reports*” and “*Description of Senior Notes—Certain Covenants—Reports*”.

TAX CONSIDERATIONS

Prospective purchasers of the New Notes are advised to consult their own tax advisors as to the consequences of purchasing, holding and disposing of the New Notes, including, without limitation, the application of U.S. federal tax laws to their particular situations, as well as any consequences to them under the laws of any other taxing jurisdiction, and the consequences of purchasing the New Notes at a price other than the initial issue price in the offering. See “*Tax Considerations*”.

TRADEMARKS AND TRADE NAMES

We own or have rights to certain trademarks or trade names that we use in conjunction with the operation of our businesses. Each trademark, trade name or service mark of any other company appearing in these Listing Particulars are the property of its respective holder.

GENERAL DESCRIPTION OF OUR BUSINESS AND THE OFFERING

This general description of our business and the offering highlights selected information contained in these Listing Particulars regarding the Group and the New Notes. It does not contain all the information you should consider prior to investing in the New Notes. You should read the entire Offering Memorandum carefully including the “Risk Factors” and the financial statements and notes thereto included in these Listing Particulars. Please see page G-1 of these Listing Particulars for a glossary of technical terms used in these Listing Particulars.

In this section, unless the context otherwise requires, the terms “Group”, “we”, “us” and “our” refers to Altice International and its subsidiaries, and following the completion of the New Transactions, these terms will also include PT Portugal and its subsidiaries; the term PT Portugal Group refers to the entities that will be acquired pursuant to the PT Portugal Acquisition. For a list of these entities, see “PT Portugal Combined Selected Financial Information—Basis of Preparation”.

Overview

We are a multinational cable and telecommunications company. We conduct our activities in three regions—Western Europe (comprising Belgium, Luxembourg, Portugal and Switzerland), Israel, and the Overseas Territories (comprising the Dominican Republic and certain French Overseas Territories in the Caribbean and the Indian Ocean regions). We provide cable and fiber-based services (high quality pay television, broadband internet and fixed line telephony) and mobile telephony services to residential and corporate customers.

We have expanded internationally through price-disciplined acquisitions and have recently entered into agreements to acquire from Oi S.A. 100% of the issued share capital of PT Portugal, and accordingly, the PT Portugal Group and its assets for an enterprise value of €7.4 billion on a cash and debt free basis, which includes a €500 million earn-out related to the future revenue generation of the PT Portugal Group (the “PT Portugal Acquisition”). The PT Portugal Group is a leading provider of integrated telecommunication services to residential and corporate customers in Portugal, including triple-play and quadruple-play services. It is the second largest pay television services provider and the market leading provider of broadband internet services and B2B services, which it provides through its fiber-to-the-home (“FTTH” or “fiber”) and DSL networks. PT Portugal is also the leading mobile services provider in Portugal. Based on the PT Portugal Combined Selected Financial Information, for the last twelve months (“LTM”) ended September 30, 2014, the PT Portugal Group had revenues of €2,565 million, EBITDA of € 997 million (EBITDA Margin of 38.9%), gross cash capital expenditures of € 448 million and EBITDA less gross cash capital expenditures of €549 million (Margin of 21.4%) and Cash Flow Conversion (defined as EBITDA less cash capital expenditure as a percentage of EBITDA) of 55.0%). The PT Portugal Acquisition transaction is subject to regulatory approval and is currently expected to close in the second quarter of 2015.

Prior to the PT Portugal Acquisition, we passed 4.1 million cable/FTTH homes with 1.6 million Cable/FTTH Customer Relationships, 3.4 million cable/FTTH-based RGUs, an average of 2.1 RGUs per Cable Customer Relationship, 4.7 million mobile telephony RGUs and had 0.5 million xDSL/non-cable/non-FTTH based fixed RGUs, as at September 30, 2014. In addition, as at September 30, 2014, the PT Portugal Group passed approximately 1.7 million homes with its FTTH network (including an approximate 36% overbuild of the 910,000 homes passed by our existing cable network in Portugal).

We are the largest or second largest cable/FTTH pay television operator and broadband internet services provider, and a leading provider of multiple-play services in our service areas. We offer bundled triple-play services, and where possible, quadruple-play services and focus our marketing on our multiple-play offerings. Our service portfolio in each of the regions in which we operate is set forth below. Our Pro Forma Adjusted EBITDA for the LTM ended September 30, 2014 was €1,991 million (which gives effect to the PT Portugal Acquisition and the ODO Acquisition and includes certain synergies we expect to achieve as a result of the PT Portugal Acquisition and certain other recently completed transactions). Please refer to “—Pro Forma Adjusted EBITDA” for further details. The table below shows the Pro Forma Adjusted EBITDA splits by geography for the LTM ended September 30, 2014, before and after giving effect to the PT Portugal Acquisition.

Altice International Pro Forma LTM ended September 30, 2014 Adjusted EBITDA Split Pre PT Acquisition¹

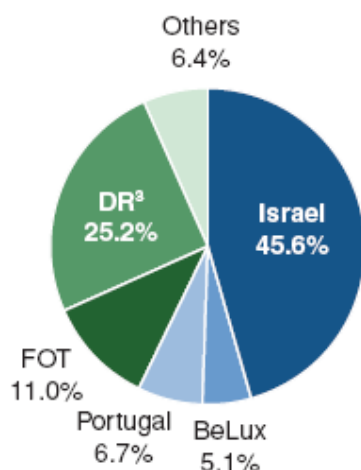

Altice International Pro Forma LTM ended September 30, 2014 Adjusted EBITDA Split Post PT Acquisition²

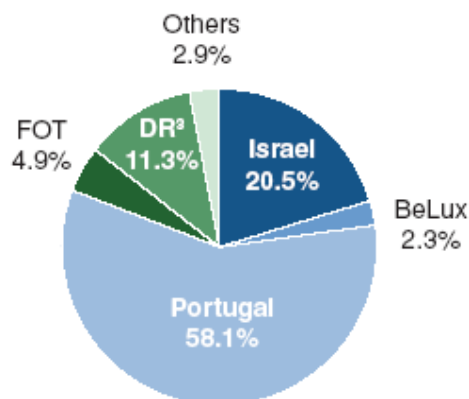

- (1) Adjusted EBITDA includes management estimate of €15 million of pro forma synergies expected to result in the medium term from expected synergies and cost savings in the Dominican Republic, Portugal and the French Overseas Territories.
- (2) Adjusted EBITDA includes management estimate of €115 million of pro forma synergies expected to result in the medium term from the PT Portugal Transaction, and certain other expected synergies and cost savings in Dominican Republic, Portugal and the French Overseas Territories.
- (3) Gives pro forma effect to the ODO Acquisition and the Tricom Acquisition for the entire LTM ended September 30, 2014.

We have a high quality cable-based and fiber-based network infrastructure. Our fixed-line services are primarily delivered over hybrid fiber coaxial (“HFC”) cable that are among the most technically advanced in the markets in which we operate and the PT Portugal Group’s FTTH networks are among the most technically advanced in Portugal. Our cable networks benefit from substantial spectrum availability and on a blended basis, are 99% Docsis 3.0-enabled as of September 30, 2014. Together with the PT Portugal Group’s FTTH networks which offer download speeds of up to 1 Gbps, this allows us to offer advanced triple-play services in a vast majority of Altice International’s service areas. Outside the Overseas Territories, our cable networks enable us to offer download speeds of at least 100 Mbps to a majority of homes passed in our footprint. Given the existing technological capability of our networks, in the short to medium term, we expect that the substantial majority of our cable networks outside the Overseas Territories will offer significant download speeds with limited network and customer premises equipment upgrades. We believe that our cable networks are well positioned for future technological developments including our ability to upgrade to the upcoming Docsis 3.1 standard while the PT Portugal Group’s FTTH networks are already set up to provide download speeds of up to 1 Gbps. In Portugal, the French Overseas Territories and the Dominican Republic we also provide fixed-line services to a portion of our customer base through a DSL network that we continue to upgrade to FTTH and HFC.

Overview of Service Portfolio Pro-forma for PT Portugal Acquisition



Geographic Area	Western Europe	Portugal	Israel	Dominican Republic	French Overseas Territories ^{1,2}	Other ³
Countries of Operation	 Belgium and Luxembourg ¹	 Portugal	 Israel	 Dominican Republic	 French Overseas Territories	Various
Bundling Strategy	4P/3P	4P	3P + Mobile	4P	4P	NA
Cable/FTTH Services Offered	<ul style="list-style-type: none"> ■ Pay television ■ Broadband internet ■ Fixed line telephony 	<ul style="list-style-type: none"> ■ Pay television ■ Broadband internet ■ Fixed line telephony ■ B2B services 	<ul style="list-style-type: none"> ■ Pay television ■ Broadband internet ■ Fixed line telephony ■ Infrastructure access ■ ISP 	<ul style="list-style-type: none"> ■ Pay television ■ Broadband internet ■ Fixed line telephony 	<ul style="list-style-type: none"> ■ Pay television ■ Broadband internet ■ Fixed line telephony 	
Mobile Services Offered	<ul style="list-style-type: none"> ■ MVNO mobile services (Belgium only) 	<ul style="list-style-type: none"> ■ 2G mobile services ■ 3G mobile services ■ 4G-LTE mobile services 	<ul style="list-style-type: none"> ■ UMTS 3G Mobile services ■ B2B iDEN mobile services³ 	<ul style="list-style-type: none"> ■ 2G mobile services ■ 3G mobile services ■ 4G-LTE mobile services 	<ul style="list-style-type: none"> ■ UMTS 3G mobile services⁴ 	
xDSL Based Services/ Other Services	<ul style="list-style-type: none"> ■ B2B services 	<ul style="list-style-type: none"> ■ B2B services ■ Pay television ■ Broadband internet ■ Fixed line telephony 	<ul style="list-style-type: none"> ■ B2B services 	<ul style="list-style-type: none"> ■ B2B services ■ Pay television ■ Internet access ■ Fixed line telephony 	<ul style="list-style-type: none"> ■ B2B services ■ Pay television ■ Fixed line telephony 	<ul style="list-style-type: none"> ■ B2B services ■ Television content

- (1) We provide our cable based services in Belgium and Luxembourg and the French Overseas Territories under the Numericable brand licensed from the Numericable Group, which is 60.3% owned by our parent Altice S.A.
- (2) We provide pay television, fixed-line telephony and internet access services over our unbundled xDSL network in certain parts of the French Overseas Territories. In Guadeloupe and Martinique we have begun to market these services under the Numericable brand which we have historically used for services provided via our cable network but we continue to use the ONLY brand in French Guiana and Mayotte, while in La Réunion we use the IZI brand.
- (3) We continue to provide our iDEN mobile services under the “MIRS” brand. On January 12, 2015, the Israeli Ministry of Communications informed HOT Mobile that based on the results of a tender regarding 4G-LTE, it would be awarded a frequency bandwidth of 2X5MHz in the 1.8 GHz spectrum, for a license fee of NIS 34.5 million (up to half of which may be paid by way of provision of a bank guarantee, which may be refunded, in whole or in part, upon HOT Mobile reaching certain market share milestones). The tender results will be brought before the Minister of Communications for approval.

- (4) In La Réunion, Mayotte and French Guiana, we continue to market our mobile services under the “ONLY” brand. However, in connection with the acquisition of SFR by Numericable Group (which is controlled by our parent Altice S.A., and therefore an affiliate of the Group), we have committed to the French Competition Authority to dispose of the mobile network assets in La Réunion and in Mayotte by mid-2015, which in aggregate contributed €10 million to aggregated and pro forma EBITDA for the fiscal year ended 2013.
- (5) Includes business and datacenter operations in Switzerland (Green and Green Datacenter), datacenter operations in France (Auberimmo) and content production and distribution businesses in France and Luxembourg (Ma Chaîne Sport and SportV). Green Datacenter and Auberimmo are designated as unrestricted subsidiaries under the terms governing the indebtedness of the Group.

Key Performance Measures

	Illustrative Aggregated Selected Financial Information ⁽¹⁾	Pre-PT/ODO Transactions Pro Forma Financial Information ⁽²⁾	Post-Transaction Pro Forma Financial Information ⁽³⁾			
			For the year ended December 31,		LTM ended September 30,	
			2012	2013	2013	2014
			€ in millions			
Revenue						
Israel	850.4	881.9	881.9	669.4	645.9	858.4
Belgium and Luxembourg.....	71.3	70.5	70.5	53.1	54.0	71.4
Portugal	235.4	209.6	2,806.3	2,098.8	2,023.7	2,731.3
o/w						
Cabovisao/ONI o/w PT Portugal Group.....	235.4	209.6	209.6	159.8	140.4	190.1
intercompany adjustments	—	—	2,627.4	1,963.2	1,900.9	2,565.1
French Overseas Territories ⁽¹⁴⁾	219.6	223.5	(30.6)	(24.3)	(17.6)	(23.9)
Dominican Republic ⁽⁵⁾	—	—	223.5	166.3	178.7	236.0
Tricom adjustment ⁽¹³⁾	—	—	446.3	333.9	327.4	439.7
Others ⁽⁶⁾	65.2	75.2	—	—	—	66.9
Total Revenue	1,441.8	1,460.6	4,503.7	3,375.0	3,365.0	4,560.6
EBITDA ⁽⁷⁾						
Israel	305.2	363.0	363.0	269.9	314.6	407.8
Belgium and Luxembourg.....	45.6	45.0	45.0	35.4	36.3	45.9
Portugal	48.0	58.3	1,084.7	820.8	790.9	1,054.6
o/w						
Cabovisao/ONI o/w PT Portugal Group.....	48.0	58.3	58.3	45.1	44.3	57.4
intercompany adjustments	—	—	1,026.4	775.7	746.6	997.2
French Overseas Territories ⁽¹⁴⁾	75.1	84.6	—	—	—	—
Dominican Republic ⁽⁵⁾	—	—	84.6	62.0	72.7	95.3
Tricom adjustment ⁽¹³⁾	—	—	173.0	131.7	150.0	191.3
Others ⁽⁶⁾	20.3	20.0	—	—	—	23.6
Total EBITDA	494.2	570.9	1,770.3	1,337.2	1,418.9	1,875.7
Equity based compensation ⁽⁸⁾	3.8	—	—	—	—	—
Adjusted EBITDA ⁽⁹⁾	498.0	570.9	1,770.3	1,337.2	1,418.9	1,875.7
Pro Forma Synergies for Previous Transactions ⁽¹⁰⁾						15.0
Pro forma Synergies for PT Portugal ⁽¹¹⁾						100.0
Pro Forma Adjusted EBITDA ⁽¹²⁾						1,990.7

(1) The Illustrative Aggregated Selected Financial Information does not aggregate the financial information of Tricom, ODO, Mobius or the PT Portugal Group. For details, see “*Illustrative Aggregated Selected Financial Information of the Group*”.

(2) The Pre-PT/ODO Transactions Pro Forma Financial Information does not give pro forma effect to the acquisition of ODO, Tricom, Mobius or PT Portugal for the year ended December 31, 2013. For details, see “*Pro Forma Financial Information of the Group*”. Pro Forma Financial Information does not give pro forma effect to the disposal of our mobile network assets in Mayotte and La Réunion which we have committed to undertake.

(3) The Post-Transaction Pro Forma Financial Information, among other things, gives pro forma effect to the acquisition of ODO (which is included under “Dominican Republic”) and PT Portugal (which is included under “Portugal”). Save for the LTM column, it does not give

pro forma effect to the acquisition of Tricom or Mobius but includes the contribution of Tricom and Mobius from March 12, 2014, and January 1, 2014, respectively, following their consolidation into the Historical Consolidated Financial Information of Altice International. For details, see “*Pro Forma Financial Information of the Group*”. Post-Transaction Pro Forma Financial Information does not give pro forma effect to the disposal of our mobile network assets in Mayotte and La Réunion which we have committed to undertake.

- (4) LTM ended September 30, 2014 is calculated by (i) adding the revenue, EBITDA or Adjusted EBITDA or other applicable line item for the nine months ended September 30, 2014 and the year ended December 31, 2013 and (ii) subtracting the revenue, EBITDA or Adjusted EBITDA or other applicable line item for the nine months ended September 30, 2013 from such sum.
- (5) Includes ODO but excludes Tricom.
- (6) Others includes our B2B telecommunications solutions business and datacenter operations in Switzerland (Green and Green Datacenter), our datacenter operations in France (Auberimmo) and our content production and distribution businesses in France and Luxembourg (Ma Chaîne Sport and SportV). For the nine months ended September 30, 2014, it also includes the contribution made by Tricom from March 12, 2014. We disposed of our interests in Valvision in 2013 (which was included in Others). Green Datacenter and Auberimmo are designated as unrestricted subsidiaries under the terms governing the indebtedness of the Group. Valvision’s and Auberimmo’s contribution to our revenue and EBITDA was not material. In each of the years ended December 31, 2011, 2012 and 2013, Green Datacenter contributed €4.3 million, €10.3 million and € 12.4 million, respectively, to aggregated and pro forma revenues and € 3.6 million, €9.0 million and €10.2 million respectively to aggregated and pro forma EBITDA. For the nine months ended September 30, 2013 and 2014, Green Datacenter contributed €8.8 million and €8.2 million to pro forma revenue and €7.6 million and €6.9 million to pro forma EBITDA, respectively.
- (7) EBITDA is defined as operating profit before depreciation and amortization, goodwill impairment, other expenses, net, management fees and restructuring and other non-recurring costs. We believe that this measure is useful to readers of our financial information as it provides them with a measure of the operating results which excludes certain items we consider outside of our recurring operating activities or that are non-cash, making trends more easily observable and providing information regarding our operating results and cash flow generation that allows investors to better identify trends in its financial performance. EBITDA should not be considered as a substitute measure for operating income and may not be comparable to similarly titled measures used by other companies.
- (8) Equity-based compensation consists of expenses pertaining to employee stock options provided to employees in Israel.
- (9) Adjusted EBITDA is defined as EBITDA before equity based compensation expenses.
- (10) Giving effect to certain synergies expected to result from the 2013 June Transactions (including the Outremer Transaction and the ONI Transaction which were consummated in the third quarter of 2013) and to certain synergies expected to result over time from the ODO Acquisition and the Tricom Acquisition. See “*General Description of our Business—History*”. These synergy estimates are based on a number of assumptions made in reliance on the information available to us and management’s judgments based on such information. The assumptions used in estimating synergies are inherently uncertain and are subject to a wide variety of significant business, economic, and competitive risks and uncertainties that could cause actual results to differ materially from those contained in the synergy benefit estimates.
- (11) Giving effect to certain synergies expected to result over time from the PT Portugal Acquisition, which is expected to include substantial cost-savings in the following areas: subcontractor rationalization, increased buying power through combined procurement, reduction in interconnection costs through re-routing to Altice’s international backbone, renegotiations of price lists with suppliers, reduction in IT spending, simplification of operating practices, and outsourcing of customer care. These synergy estimates are based on a number of assumptions made in reliance on the information available to us and management’s judgments based on such information. The assumptions used in estimating synergies are inherently uncertain and are subject to a wide variety of significant business, economic, and competitive risks and uncertainties that could cause actual results to differ materially from those contained in the synergy benefit estimates.
- (12) For reconciliation of Pro Forma Adjusted EBITDA to Adjusted EBITDA, see “*Summary Financial Information and Other Data—Pro Forma Adjusted EBITDA*”.
- (13) For the purposes of the LTM ended September 30, 2014, only, pro forma effect is given to the acquisition of Tricom, including the non-consolidated portion of Tricom prior to Tricom’s consolidation into the Historical Consolidated Financial Information of Altice International from March 12, 2014, which is accounted for under “Tricom adjustment”, and the contribution of Tricom from March 12, 2014, following its consolidation into the Historical Consolidated Financial Information of Altice International.
- (14) For the nine months ended September 30, 2014, it also includes the contribution of Mobius.

Key Operating Measures

Pre PT Portugal Acquisition⁽¹⁾

	As of and for the nine months ended September 30, 2014 in thousands except percentages and as otherwise indicated					
	Israel	Belgium and Luxembourg	Portugal	French Overseas Territories	Dominican Republic	Total
CABLE-BASED SERVICES						
Market and Network						
Homes Passed.....	2,329	233	910	178	473 ⁽¹¹⁾	4,123
Docsis 3.0 Upgraded (%).....	100%	100%	99%	95%	100%	99.5%
Unique Customers						
Cable Customer Relationships.....	1,088	110	225	44	119	1,586
Triple-Play Cable Customer Relationships	484	50	133	26	15	708

RGUs & Penetration

Total RGUs	2,270	231	578	95	198	3,372
Pay Television RGUs	862	120	214	44	114 ⁽²⁾	1,354
Pay Television Penetration (%)	37%	52%	24%	25%	24%	32.8%
Broadband Internet RGUs	727	59	152	26	41	1,005
Broadband Internet Penetration (%)	31%	25%	17%	15%	9%	24%
Fixed-Line Telephony RGUs	681	52	213	26	42	1,014
Fixed-Line Telephony Penetration (%)	29%	22%	23%	14%	9%	25%
RGUs Per Cable Customer Relationship	2.1x	2.1x	2.6x	2.2x	1.7x	2.1x

ARPU

Cable ARPU (€)	48.8	43.6	34.3	55.6	21.1	—
----------------------	------	------	------	------	------	---

MOBILE-BASED SERVICES**Market and Network**

UMTS Mobile Coverage of Territory (%)	56.3%	—	—	90% ⁽⁹⁾	77%	—
---	-------	---	---	--------------------	-----	---

Subscribers

Total Mobile Subscribers	932	3	—	365	3,391	4,691
Post-paid	927	3	—	205	702	1,837
Prepaid	5	—	—	160	2,690	2,855

ARPU

Mobile ARPU (€)	15.0	32.2	—	28.4	8.5	—
-----------------------	------	------	---	------	-----	---

xDSL/NON-CABLE BASED SERVICES**RGUs**

Total RGUs	—	—	—	152	336	488
Broadband Internet RGUs	—	—	—	54	97	151
Fixed Line Telephony RGUs	—	—	—	90	239	329

(1) Please refer to "Summary Financial Information and Other Data—Key Operating Measures" for further details, including the notes to such operating data.

PT Portugal Operating Data

As of December 31,			As of September 30,	
2011	2012	2013	2013	2014
in thousands except number of RGUs per individual user and ARPU or unless otherwise indicated				

PTC**Fixed retail accesses (residential and enterprise):**

PSTN/ISDN ⁽¹⁾	2,648	2,604	2,549	2,564	2,503
Broadband customers	1,105	1,225	1,294	1,280	1,354
Pay-TV customers	1,042	1,223	1,315	1,294	1,387
Total fixed retail accesses	4,795	5,052	5,158	5,137	5,244
Triple or Quadruple Play customers	679	833	952	921	1,065
Unique customers	2,851	2,814	2,745	2,766	2,670
Total fixed retail accesses/unique customer	1.68	1.80	1.88	1.86	1.96
Non-voice revenues as % of revenues	46.2	51.2	53.2	53.0	55.2

Net additions:⁽²⁾

PSTN/ISDN	(48)	(43)	(55)	(40)	(46)
Broadband customers	104	119	69	55	60
Pay-TV customers	212	181	91	70	73
Total fixed retail accesses net additions	268	257	105	85	87

Residential⁽³⁾**Fixed retail accesses (residential only)**

PSTN/ISDN	1,674	1,692	1,646	1,652	1,631
Broadband customers	911	1,015	1,027	1,019	1,075
Pay-TV customers	972	1,135	1,157	1,146	1,209
Total fixed retail accesses	3,557	3,841	3,830	3,817	3,915
Triple or Quadruple Play customers	623	769	824	803	912
Unique customers	1,881	1,881	1,818	1,830	1,779
Total fixed retail accesses/unique customer	1.89	2.04	2.11	2.09	2.20
ARPU (€/month)	30.8	31.6	31.6	31.7	31.9
Non-voice revenues as % of revenues	58.5	63.4	65.7	65.4	68.2

Net additions⁽²⁾

PSTN/ISDN	1	18	(22)	(16)	(15)
Broadband customers	102	104	29	22	48
Pay-TV customers	198	162	43	31	52
Total fixed retail accesses net additions	300	284	50	36	85

Enterprise⁽⁷⁾**Fixed retail accesses (enterprise only)**

PSTN/ISDN	826	725	720	727	695
Broadband customers	193	207	264	258	276
Pay-TV customers	68	86	155	146	176
Total fixed retail accesses net additions	(30)	(68)	60	51	8
Unique customers	846	745	724	730	724
Total fixed retail accesses/unique customer	1.28	1.37	1.57	1.55	1.58
Non-voice revenues as % of revenues	46.4	50.3	55.0	53.9	58.4
Meo, S.A.					
Total mobile customers (personal and enterprise).....	7,444	7,598	7,896	7,807	7,881
Post-paid	2,378	2,469	2,925	2,782	3,554
Prepaid	5,066	5,129	4,971	5,025	4,327
Data as percentage of mobile services revenues	27.2	32.6	36.5	36.2	39.2
Net additions:⁽²⁾					
Total mobile customers	24	154	298	209	(15)
Post-paid	87	91	456	313	629
Prepaid	(63)	63	(158)	(104)	(644)
Personal⁽⁴⁾					
Total mobile customers (personal only)	5,932	6,024	6,390	6,320	6,336
Post-paid	1,064	1,093	1,570	1,457	2,132
Prepaid	4,868	4,931	4,820	4,863	4,205
Minutes of Usage (MOU) (m) ⁽⁵⁾	89	93	98	96	106
ARPU (€/month)	9.7	8.7	7.6	7.7	7.3
Customer	8.7	8.0	7.6	7.2	6.7
Interconnection	1.0	0.7	0.5	0.5	0.6
SARC ⁽⁶⁾ (€)	27.8	27.9	24.6	24.7	23.4
Data as % of mobile service revenues	30.9	33.2	35.8	35.6	38.2
Net additions⁽²⁾					
Total mobile customers (personal only)	(31)	92	312	243	(53)
Post-paid	42	30	441	328	562
Prepaid	(73)	62	(129)	(85)	(615)
Enterprise⁽⁷⁾					
Total mobile customers (enterprise only)	1,445	1,514	1,457	1,433	1,503
Net additions⁽²⁾					
Total mobile customers	55.6	68.7	(3.8)	(28.2)	45.7

(1) The public switched telephone network, or PSTN, is the traditional telephone system that runs through copper lines. The integrated digital services network, or ISDN, is the digital telecommunications network that allows simultaneous voice and data transmission over an access line.

(2) The net additions figures for the nine months ended September 30, 2013 and 2014 are calculated on a nine-month basis from December 31, 2012 and 2013, respectively.

(3) The PT Portugal Group's residential customer category provides fixed line telephone and broadband services, Pay-TV services (IPTV over ADSL and fiber and DTH satellite TV) and internet access services to residential customers. PTC is the primary operating company through which the PT Portugal Group provides such residential services.

(4) The PT Portugal Group's personal customer category provides telecommunications and mobile data services for a variety of personal devices, including traditional cell phones, smartphones, tablets and laptops through our mobile business. Meo, S.A. is the primary operating company through which the PT Portugal Group provides its mobile services.

(5) Minutes of Usage represents the monthly average of outgoing traffic in minutes divided by the average number of users in the period.

(6) Subscriber Acquisition and Retention Cost, or SARC, equals the sum of 70% of marketing and publicity costs plus commissions plus subsidies, divided by gross additions plus upgrades.

(7) The PT Portugal Group's enterprise customer category provides enterprise services (including integrated voice, data and image solutions, virtual private networks, convergence solutions, consultancy and outsourcing) to corporate, SMEs and SoHo customers that need diversified telecommunications solutions and integration with IT services through service packages. PTC and, to a lesser extent, Meo, S.A., are the primary operating companies through which the PT Portugal Group provides its enterprise services.

Our cable and fiber technologies enable us to offer premium digital services, attractive interactive features and local content to our subscribers. We have leveraged our network advantage to drive our multiple-play strategy and offer an attractive combination of content, speed and functionality. We experienced a significant increase in the percentage of triple-play subscribers, reaching 708,000 triple-play customers as of September 30, 2014 compared to 622,000 triple-play customers as of December 31, 2012 (including the Overseas Territories, but excluding the PT Portugal Group), translating into growth in RGU per unique cable customer relationship. We expect this trend of upselling to higher RGUs per subscriber to continue.

Cable-Based Services ARPU Growth and Triple-play Penetration

	2012	2013	Q3 2014
Portugal⁽¹⁾			
PT Portugal Residential ARPU (€)	31.6	31.6	31.9
PT Portugal Growth (%) ⁽²⁾	2.7%	0.3%	0.9%
PT Portugal 3P/4P Penetration (%).....	41%	45%	51%
Cabovisao Cable ARPU (€)	34.9	34.6	33.4
Cabovisao Growth (%) ⁽²⁾	(5.4)%	(0.9)%	(3.5)%
Cabovisao 3P Penetration (%)	58%	57%	59%
Israel⁽³⁾			
Cable ARPU (€)	44.4	47.6	48.8
Growth (%) ⁽²⁾	4.7%	7.2%	2.5%
3P Penetration (%).....	34%	40%	45%
Belgium & Luxembourg⁽⁴⁾			
Cable ARPU (€)	39.5	41.9	43.6
Growth (%) ⁽²⁾	7.6%	6.1%	4.1%
3P Penetration (%).....	42%	44%	45%
French Overseas Territories⁽⁵⁾			
Cable ARPU (€)	48.3	51.4	55.6
Growth (%) ⁽²⁾	12.1%	6.4%	8.2%
3P Penetration (%).....	31%	42%	59%
Dominican Republic⁽⁶⁾			
Cable ARPU (€) ⁽⁷⁾	21.5	19.7	21.1
Growth (%) ⁽²⁾	(9.6)%	(3.7)%	7.1%
3P Penetration (%) ⁽⁸⁾	13%	16%	13%

(1) Portugal represents operating measures of Cabovisao (in which we acquired a controlling interest in February 2012) and the PT Portugal Group (which we agreed to acquire on December 9, 2014).

(2) For 2012 and 2013, represents year on year growth. For Q3 2014, represents growth compared to 2013.

(3) Israel represents operating measures of HOT (in which we acquired a controlling interest in March 2011).

(4) Belgium and Luxembourg represents operating measures of Coditel Belgium and Coditel Luxembourg (in which we acquired a controlling interest in June 2011).

(5) French Overseas Territories represents operating measures of Le Cable and excludes Outremer (in which we acquired a controlling interest in July 2013).

(6) Dominican Republic represents Tricom (in which we acquired a controlling interest in March 2014).

(7) Cable ARPU in the Dominican Republic includes only revenues related to pay television services and also revenues from additional set-top boxes and other value-added and premium services. Does not include ARPU from broadband internet and fixed line telephony services.

(8) Blended 3P penetration in the Dominican Republic is shown for cable and xDSL/non-cable based customers.

We aim to maximize return on our investments by implementing our investment strategy, IT and network planning as well as procurement initiatives at the Altice Group level. We have implemented common technological platforms across many of our networks in order to gain economies of scale, notably with respect to billing systems, network improvements and cable customer premises equipment. We have also achieved substantial reductions in our operating expenses as we implemented the same best practice operational processes across our organization. We have simplified the services we offer, increased the level of outsourcing of customer service, customer installations and network maintenance and reduced costs through the negotiation of attractive interconnection rates and improved pricing of our television content. We believe that sharing of best practices across our regions and identifying group synergies are key drivers of our operational performance improvements, operating margin increases and organic cash-flow growth.

We have an acquisition strategy whereby we target cable and FTTH operators with what we believe to be quality networks in markets we find attractive from an economic, competitive and regulatory standpoint and create value at the acquired businesses by implementing operational improvements and leveraging economies of scale, as well as pursuing in-market consolidation and attractive diversification with B2B, DSL and mobile add-on opportunities. We aim to substantially improve the operational performance of businesses we acquire, thereby providing the cash flow generation to help fund future growth.

PT Portugal Acquisition Overview

Subject to regulatory approval, the acquisition of PT Portugal will result in the combination of the assets of the PT Portugal Group, with our existing Portuguese businesses, Cabovisão (B2C business offering cable-based pay television, broadband internet and fixed-line telephony services) and ONI (B2B business). We believe that after completion of the PT Portugal Acquisition, we will be a leading telecommunications operator in B2C and B2B segments and the second largest service provider of B2C pay television services in Portugal. The PT Portugal Group had a market share of 42% in B2C pay television, 51% in B2C broadband internet, 47% in B2C mobile and 48% in B2B Enterprise, as of December 31, 2013, according to company filings, Anacom and Analysys Mason.

Based on the PT Portugal Combined Selected Financial Information, the PT Portugal Group generated revenues of €2,627.4 million for the year ended December 31, 2013 and €2,565.1 million for the LTM ended September 30, 2014, and EBITDA of €1,026.4 million for the year ended December 31, 2013 (EBITDA Margin of 39.1%) and of €997.2 million for the LTM ended September 30, 2014 (EBITDA Margin of 38.9%).

For further details, see “—Recent Developments” and “The Transactions”.

PT Portugal Expected Synergies

We believe that the PT Portugal Group will be in a position to realize substantial cost savings from the advantages of being a part of the broader Altice Group. We expect that the PT Portugal Group will realize substantial cost savings in the following areas: subcontractor rationalization, increased buying power through combined procurement, reduction in international content costs brought to the level of Altice Group’s benchmarks, reduction in interconnection costs through re-routing to Altice’s international backbone, renegotiation of price lists with suppliers, reduction in IT spending, simplification of operating practices, and outsourcing of customer care. We also expect that Altice Group will realize capital expenditure savings through benefits of scale in procurement, adoption of Altice best practices in capital expenditure planning and efficiency savings in network speed.

Across our geographies, we have a successful track record of improving the performance of cable and telecommunication operators we acquire. We expect to continue to grow our operating margins by focusing on cost optimization and increasing economies of scale and operational synergies as we integrate the recently acquired businesses, and the PT Portugal Acquisition, into the Group. Furthermore, we expect to realize capital expenditures synergies as result of increasing economies of scale and improved negotiating leverage with counterparties as the Altice Group expands. In addition, we also aim to reduce churn by continuously improving our service quality, bundling and subscriber satisfaction, which we expect to drive growth in our operating margin.

Management estimates total annual cost synergies impacting EBITDA and total annual synergies impacting capital expenditure, which are expected to result in the medium term from the PT Portugal Acquisition in the medium term, to be approximately €100 million and approximately €40 million, respectively. However, this synergies estimate is based on a number of assumptions made in reliance on the information available to us and management’s judgments based on such information. The assumptions used in estimating synergies are inherently uncertain and are subject to a wide variety of significant business, economic, and competitive risks and uncertainties that could cause actual results to differ materially from those contained in the synergies benefit estimates.

PT Portugal Group Overview

B2C Pay Television: The PT Portugal Group is the second largest pay television service provider in Portugal with 1.3 million subscribers and 42% market share as of December 31, 2013, according to Anacom. The PT Portugal Group offers exclusive and differentiated premium content, advanced functionalities, such as multiplatform support, and an interactive customer experience, through its FTTH network and DTH satellite technology. Pay television penetration in Portugal stood at 85.9%, as per Ovum Research for 2014. Following the PT Portugal Acquisition, we believe that we will be well placed to benefit from an increase in pay television penetration in Portugal, which is estimated to increase to 98.2% by 2017, according to Ovum Research estimates.

B2C Broadband Internet: The PT Portugal Group is the market leader in Portugal in the provision of broadband internet to consumers, with 1.3 million subscribers and 42% market share, as of December 31, 2013, according to Anacom. Of the 3.9 million primary households in Portugal, the PT Portugal Group covers almost all the homes with its copper DSL network and 1.7 million of the households are passed by PT Portugal Group’s FTTH networks (which includes an approximate 36% overbuild with the 910,000 homes passed by Cabovisao’s existing cable network in Portugal). The PT Portugal Group is the sole fixed infrastructure provider on a portion of its footprint, in mainly rural areas of Portugal where cable operators and Vodafone have no fixed network. The PT Portugal Group has made significant investments in its fiber transmission network that supports up to 100 Gbps and its FTTH access network that offer speeds up to 1 Gbps.

B2C Mobile: The PT Portugal Group is the largest mobile operator in Portugal with 6.4 million subscribers and 47% market share as of December 31, 2013, according to Anacom. The PT Portugal Group has a state of the art 4G-LTE network, covering 95% of population and allowing speeds up to 150 Mbps, in addition to nationwide 3G and 2G networks. We believe that the PT Portugal Group's strong market position in the mobile segment is complementary with Cabovisao's existing fixed line only operations and will allow us to be a leading convergent operator in Portugal, with an attractive quadruple play offering.

B2C Bundling: We believe that we will be well placed to capitalize on the growing trend of bundling of telecom services, in triple and quadruple play packages. As of September 30, 2014, the PT Portugal Group had multiple-play penetration (3P/4P) of 51% (0.9 million customers) compared to 71% (3P/4P) for NOS based on its public filings and 59% for Cabovisao. In 2013, the PT Portugal Group introduced its quadruple-play (M4O) and triple-play (M3O) offers, which have been well received by the market with M4O winning the Consumer Choice for best quadruple-play service in Portugal in 2013. For the nine months ended September 30, 2014, the PT Portugal Group's residential ARPU and personal ARPU amounted to €31.9, and €7.3 respectively, as compared to €31.7 and € 7.7 for the nine months ended September 30, 2013. Through the development of its advanced fixed-mobile infrastructure, we believe that the PT Portugal Group is well placed to increase its penetration of triple-play and quadruple play packages among its customer base.

B2B Enterprise: In the B2B Enterprise segment, the PT Portugal Group is the leading B2B player in the Portuguese market. The PT Portugal Group benefits from an extensive fiber and DSL network in Portugal, with a market share of approximately 48% based on revenues, according to Analysys Mason. A significant number of the PT Portugal Group's clients are connected through FTTH. We believe that the PT Portugal Group also benefits from strong customer relationships. Through PT Portugal Group's and our investments in infrastructure and telecom-IT convergence, we will aim to develop and market advanced integrated solutions for the B2B segment that will include IT/IS services and value added services (such as cloud outsourcing and BPO).

B2B Wholesale/Others: As the incumbent telecom provider in Portugal, the PT Portugal Group is the primary provider of wholesale telecom capacity to resellers in the Portuguese market.

Cabovisao/ONI

Cabovisao, our existing B2C operator in Portugal, is a triple-play provider of pay television, broadband internet and fixed-line telephony services. As of December 31, 2013, Cabovisao had 224,000 pay television subscribers, 156,000 broadband internet subscribers and 223,000 fixed-line telephony subscribers, representing a 7%, 6% and 5% market share respectively, according to Anacom and Ovum Research. Cabovisao owns a fully upgraded (99%) Docsis 3.0 network capable of delivering speeds of up to 360 Mbps. The backbone of Cabovisao is widespread over 3,647 kilometers with approximately 36% overbuild of the PT Portugal Group's FTTH network. Our existing B2B Enterprise business ONI has a next generation network, with more than 9,000km of fibre and 427 points of presence, supporting 17,500 customer sites with fibre access.

Cabovisao and ONI generated cable-based revenues of €108.7 million for the year ended December 31, 2013 and of €101.0 million for the LTM ended September 30, 2014, B2B revenues of €100.9 million for the year ended December 31, 2013 and of €89.0 million for the LTM ended September 30, 2014, total revenues of €209.6 million for the year ended December 30, 2013, and of €190.1 million for the LTM ended September 30, 2014, and EBITDA of €58.3 million for the year ended December 31, 2013 (EBITDA Margin of 27.8%), and of €57.4 million for the nine months ended September 30, 2014 (EBITDA Margin of 30.2%).

Summary Financials

The table below summarizes our growth in revenues, Adjusted EBITDA and Adjusted EBITDA less capital expenditures:

	Historical Consolidated Financial Information				Illustrative Aggregated Selected Financial Information ⁽¹⁾		Post-Transaction Pro Forma Financial Information ⁽²⁾			
	For the year ended December 31,			For the nine months ended September 30,	For the year ended December 31,		For the year ended December 31,	For the nine months ended September 30,		LTM ended September, 30 ⁽³⁾
	2011	2012	2013	2014	2011	2012	2013	2013	2014	2014
	€ in millions									
Revenue	784.2	1,092.4	1,286.8	1,372.8	1,426.2	1,441.8	4,503.7	3,375.0	3,365.0	4,560.6
of which Tricom adjustment ⁽⁷⁾										66.9
Adjusted EBITDA ⁽⁴⁾	303.8	406.9	518.8	626.9	503.2	498.0	1,770.3	1,337.2	1,418.9	1,875.7
of which Tricom adjustment ⁽⁷⁾										23.6
Capital Expenditures ⁽⁵⁾	189.8	347.0	290.1	306.6	293.8	397.8	932.7	676.5	631.5	904.7
of which Tricom adjustment ⁽⁷⁾										17.0
Adjusted EBITDA—Capital Expenditures	114.0	59.9	228.7	320.3	209.4	100.2	837.6	660.7	787.4	971.0
of which Tricom adjustment ⁽⁷⁾										6.6
Pro Forma Adjusted EBITDA ⁽⁶⁾										1,990.7
Pro Forma Adjusted EBITDA— Capital Expenditures										1,086.0

- (1) The Illustrative Aggregated Selected Financial Information does not aggregate the financial information of Tricom, ODO, Mobius and the PT Portugal Group. For details, see “*Illustrative Aggregated Selected Financial Information of the Group*”.
- (2) The Post-Transaction Pro Forma Financial Information, among other things, gives pro forma effect to the acquisition of ODO and PT Portugal. Save for the LTM column, it does not give pro forma effect to the acquisition of Tricom or Mobius but includes the contribution of Tricom and Mobius from March 12, 2014, and January 1, 2014, respectively, following their consolidation into the Historical Consolidated Financial Information of Altice International. For details, see “*Pro Forma Financial Information of the Group*”. Post-Transaction Pro Forma Financial Information does not give pro forma effect to the disposal of our mobile network assets in Mayotte and La Réunion which we have committed to undertake.
- (3) LTM is calculated by (i) adding the revenue, EBITDA or Adjusted EBITDA, as applicable, for the nine months ended September 30, 2014 and the year ended December 31, 2013 and (ii) subtracting the revenue, EBITDA or Adjusted EBITDA, as applicable, for the nine months ended September 30, 2013 from such sum.
- (4) Adjusted EBITDA is defined as operating income before depreciation and amortization, goodwill impairment, management fees, other expenses, net and reorganization and non recurring costs (EBITDA) and before equity based compensation expenses. Adjusted EBITDA is unaudited. We believe that these measures are useful to readers of our financial as it provides them with a measure of the operating results which excludes certain items we consider outside of our recurring operating activities or that are non cash, making trends more easily observable and providing information regarding our operating results and cash flow generation that allows investors to better identify trends in its financial performance. Adjusted EBITDA should not be considered as a substitute measure for operating income and may not be comparable to similarly titled measures used by other companies (including the PT Portugal Group). “Adjusted EBITDA” of Altice International presented herein corresponds to “EBITDA” as reported by Altice International for financial reporting purposes as of September 30, 2014.
- (5) For the Post Transaction Pro Forma Financial Information, capital expenditures have been calculated by aggregating (i) the Group’s cash capital expenditures based on the Pre Transaction Pro Forma Financial Information, (ii) the cash capital expenditures of ODO based on the historical financial statements of ODO and Altice International, as applicable and (iii) the cash capital expenditures of the PT Portugal Group based on the PT Portugal Combined Selected Financial Information.
- (6) For reconciliation of Pro Forma Adjusted EBITDA to Adjusted EBITDA, see “*Summary Financial Information and Other Data—Pro Forma Adjusted EBITDA*”.
- (7) For the purposes of the LTM ended September 30, 2014, only, pro forma effect is given to the acquisition of Tricom, including the non-consolidated portion of Tricom prior to Tricom’s consolidation into the Historical Consolidated Financial Information of Altice International from March 12, 2014, which is accounted for under “Tricom adjustment”, and the contribution of Tricom from March 12, 2014, following its consolidation into the Historical Consolidated Financial Information of Altice International.

Our Competitive Strengths

We believe that we benefit from the following key strengths:

We enjoy leading positions in the pay television and broadband internet services in well diversified markets with favorable dynamics for cable and fiber operators. After giving effect to the PT Portugal Acquisition, we are the largest or second largest cable/FTTH pay television operator and broadband internet services provider in our service areas. In a significant majority of our footprint outside of Portugal, we are the sole cable operator. We are located in markets that we believe have a number of attractive trends for cable and mobile operators. Pro forma for the PT Portugal Acquisition, Portugal will be our largest geography by revenue and EBITDA. In Portugal, we will benefit from the PT Portugal Group’s number one positions in broadband internet, fixed-line telephony and enterprise telecom services and the number two position in pay television which it provides through a fixed network covering 1.7 million homes with FTTH out of a total of 3.9 million homes in Portugal. Cabovisao’s network passes approximately 910,000 homes in Portugal through cable (with approximately 36% overbuild of the PT Portugal Group’s FTTH network), and is 99% DOCSIS 3.0

enabled. We will also be the largest mobile operator in Portugal. The PT Portugal Group's mobile network in Portugal is already upgraded to 4G LTE and currently covers 95% of the population allowing speeds up to 150 Mbps, in addition to nationwide 3G and 2G networks. In Israel, we are the leading cable operator with the number one market position in pay television and number two position in broadband internet and we benefit from nationwide cable network coverage, a unique feature in the cable sector, which we believe provides us with significant penetration upside potential. All of the countries in which we currently operate have historically had high consumption of television and high pay television penetration combined with a relatively weak free-to-air television proposition. Broadband internet penetration in our footprint, and in particular in Israel, Belgium and Luxembourg, also compares favorably with most other West European markets.

We believe that we benefit from a fixed network advantage in each of our markets. We own our HFC networks that, on a blended basis, are 99% Docsis 3.0 enabled, as of September 30, 2014, and, in Portugal, the PT Portugal Group owns one of the largest FTTH networks by penetration reaching 1.7 million homes (43% penetration). We believe our state-of-the-art networks allow us to offer attractive and competitive services in terms of picture quality, speed and connection reliability. Outside the Overseas Territories, where network upgrades are currently underway, we are able to offer download speeds of at least 100 Mbps to a vast majority of homes passed in our footprint. Given the existing technological capability of our networks, in the short to medium term, we expect to offer download speeds of up to 360 Mbps with limited network and customer premises equipment upgrades across a substantial portion of our network. We currently have a network advantage in terms of download speed across a part of our cable service area across geographies (excluding the Dominican Republic and Portugal) and, specifically in Israel, where we expect to continue offering faster speeds than our competitor's legacy technology and at par with it in areas where it has deployed FTTH. We believe that with our HFC, and following the PT Portugal Acquisition, FTTH technologies we are well positioned for future technological developments making it possible for us to increase broadband internet download and upload speeds exceeding those offered by competing technologies, without making significant additional investments.

The following table sets forth the key characteristics of our cable network:

	Altice Key Geographies					European Peers		
	Israel	Belgium/ Luxembourg	Portugal	French Overseas Territories ⁽¹⁾	Dominican Republic	Ziggo	Telenet	KDG
Cable Network Capacity	600-862 MHz	550-860 MHz	750 MHz	550 MHz	Primarily 750-1,000 MHz ⁽²⁾	862 MHz	600 MHz	Mainly 640 MHz
Docsis 3.0 Upgrade (%).....	100	100	99	95	100	100	100	95
Homes Passed per node	~1,250	~645	~1,092	~140	~750	1,500	~580	>1,500
Advertised Speed (Mbps)	30-200	50-200	30-360	20-30	1-100	20-150	60-120	10-100
Homes passed with FTTH Connections						PT Portugal Group		
						1.7 million		

(1) Only relates to the cable based services we provide in Guadeloupe and Martinique and excludes services provided over our xDSL platform.

(2) 91% of Tricom's cable network as of September 30, 2014.

We are a leading multiple-play provider of cable and/or FTTH based services in our markets with substantial cross-sell and up-sell opportunities in fixed, mobile and B2B. Building on our technologically advanced networks and innovative offerings, we have developed leading positions in our markets in multiple-play offerings by selling our differentiated pay television, high speed broadband internet, fixed line telephony and, in most instances, mobile telephony services as bundles. We believe that the strength of our pay television, broadband internet and fixed telephony businesses and our ability to offer advanced mobile telephony services makes us well positioned to increase penetration of multiple-play and premium packages. We believe that continued focus on our bundling strategy and increasing our triple-play or, where possible, quadruple-play penetration will enable us to grow our cable/ FTTH based services ARPU. The demand for high speed internet, fixed mobile convergence and high quality content together with opportunities provided by leveraging our networks as a result of the PT Portugal Acquisition and ODO Acquisition are key drivers of our cross-sell and up-sell strategy.

According to Ovum Research, worldwide subscribers for high-speed broadband internet are expected to increase at a 6% rate between 2013 and 2016. We believe that we are well positioned to capitalize on this trend as we offer download speeds of at least 100 Mbps to a majority of homes passed in our footprint (other than the portion of homes passed in the Overseas Territories that are currently not Docsis 3.0 enabled). In Portugal, the PT Portugal Group is a leading provider of multiple-play services and the market leading provider of broadband internet services, which we believe provides upsell opportunities in fixed telephony and mobile telephony. In Israel, HOT is the sole triple-play provider in the market and enjoys the leading market position in pay television and the number two market position in broadband and fixed telephony. In addition, we have been offering mobile services through our own mobile network since 2012, and we see the increase in penetration of mobile subscribers as a key potential upside.

Pro forma for the PT Portugal Acquisition, we will have a fully integrated fixed mobile business in Portugal, Israel and the Overseas Territories. Following the PT Portugal Acquisition, we believe that we will be well positioned to benefit from convergence between fixed and mobile service offerings in Portugal by leveraging the PT Portugal Group's high speed fiber-based fixed network and 4G mobile network. The PT Portugal Group currently provides innovative triple-play and quadruple-play bundles through the MEO brand and we believe there are significant cross selling opportunities through increased penetration of converged services. We own and operate a 3G mobile network in Israel and in the French Overseas Territories which, in each case, benefit from synergies with our cable networks, whereas in Belgium we complement our fixed-line products with mobile offerings through an MVNO arrangement. We have a premium, high quality content offering in all of our markets. In Portugal, the PT Portugal Group offers a high quality content package through more than 220 channels and a leading VOD library. In Israel, we co-develop and co-own high quality original local content together with local producers and broadcast it on our proprietary channels. We believe that our high quality proprietary local content, along with high quality local content we purchase and our distinctive brand enable us to attract new and retain existing subscribers to our cable based services.

In the Dominican Republic, we target increasing revenues by cross-selling Tricom's high-speed broadband internet and pay television offerings to ODO's existing customers and ODO's mobile services to Tricom's customers in addition to offering new services that utilize both companies' product sets and networks. We also have an opportunity to upsell ODO's DSL customers to Tricom's cable network.

We benefit from strong EBITDA margin and scalable capital expenditures translating into strong organic cash flow.

On a historical consolidated basis, our Adjusted EBITDA as a percentage of revenues increased from 38.0% in fiscal year ended December 31, 2011, to 45.4% in the nine months ended September 30, 2014, primarily as a result of operational efficiencies implemented by us across the organization, in addition to acquisitions of higher margin businesses. The operational efficiencies have been complemented by efficient capital expenditure as, on a blended basis, 99% of our cable networks (before giving effect to the PT Portugal Acquisition, the ODO Acquisition and the Tricom Acquisition) are already upgraded to Docsis 3.0, making our cable based business's capital expenditures largely success driven, including network upgrades and customer acquisition related investments. Pro forma for the PT Portugal Acquisition, we generated in the LTM ended September 30, 2014, Pro Forma Adjusted EBITDA as a percentage of revenues of 43.7% and Pro forma Adjusted EBITDA less capital expenditure as a percentage of Pro Forma Adjusted EBITDA of 54.6% (including certain expected aggregated synergies and cost savings from the PT Portugal Acquisition and certain other recently completed transactions). We believe that we will benefit from the PT Portugal Group's well invested FTTH-based fixed network and 4G-LTE mobile network in Portugal, and we consequently expect to further improve our cashflow conversion as a result of the PT Portugal Acquisition. We expect our increased scale to enable us to further reduce operating expenses and capital expenditures through optimized purchasing. We will continue to upgrade the portions of our cable network where we see strong return on investment, including in the French Overseas Territories of Guadeloupe and Martinique as well as in the Dominican Republic.

We have a proven track record of making attractive acquisitions and of unlocking value through operational excellence.

We believe that our entrepreneurial culture and efficient decision making processes allow us to quickly react to changes in our operating environments and to seize business opportunities as they arise. We believe a key driver of our success is our ability to identify attractive acquisition targets and assess the associated potential for value creation, consummate the acquisitions on terms economically attractive to us and consistently and timely implement best operational practices that drive the previously identified improvements in the profitability of acquired businesses. We have historically been able to acquire fixed and mobile networks operators in what we believe to be new attractive markets and create value through operational synergies. We have expertise in operating cable operators in numerous countries and business environments, with consistent focus on fostering cash-flow growth. In our acquired businesses, we have been successful at optimizing costs, capital expenditures, internal processes and outsourcing certain functions while preserving and enhancing the quality of service we provide to our subscribers. For example, in our Israeli business, following the acquisition of control by the Group over HOT in 2011, Israel's EBITDA margin increased to 49% for the nine months ended September 30, 2014 from 39% for the year ended December 31, 2011; and in our Portuguese business, following the acquisition of control by the Group over Cabovisao in February 2012, our Portuguese business's EBITDA margin increased to 32% in the nine months ended September 30, 2014 from 14% for the year ended December 31, 2011; in our BeLux business, following the acquisition of control by the Group over Numericable in 2011, Coditel EBITDA margin increased to 67% for the nine months ended September 30, 2014 from 62% for the year ended December 31, 2011; and in the Dominican Republic, our cost restructuring efforts following the acquisition of ODO in April 2014 have resulted in an increase in EBITDA margin from 39% for the year ended December 31, 2013 to 46% for the nine months ended September 30, 2014. We believe that PT Portugal will benefit from certain cost advantages as part of the broader Group, including technological know-how and improved procurement terms. We expect to realize operational synergies from the optimization of procurement, marketing spending, including the convergence to a unique brand, and IT through simplification of processes and offerings.

We have an experienced management team with a long term industry track record. We manage our business by combining the expertise of the Altice senior management team with the local expertise of the managers of our operating

subsidiaries who have significant experience managing day-to-day operations at cable and telecommunications companies. We are a wholly-owned subsidiary of Altice S.A., which is controlled by Patrick Drahi, founder of Altice, who has over 20 years of experience owning and managing cable and telecommunications companies globally. Among Mr. Drahi's achievements is the roll-up of the French cable and telecom market into the Numericable Group and Completel and, following the completion of the acquisition by the Numericable Group of SFR in November 2014, SFR. The Altice S.A. senior management team has extensive experience in the cable and telecommunications sectors. Before joining Altice in 2009, Dexter Goei (CEO) worked for 15 years in investment banking, most recently as Co-Head of the Media & Telecommunications Group for Europe, Middle East and Africa at Morgan Stanley. Before joining Altice in 2012, Dennis Okhuijsen (CFO) worked for 17 years in the cable sector with UPC, UGC and Liberty Global, most recently as Group Treasurer of Liberty Global. Before joining Altice in 2005, Jérémie Bonnin (General Secretary) worked for 7 years at KPMG in Transaction Services. Before joining Altice in 2013, Max Aaron (General Counsel) was a partner at Allen & Overy for over 14 years focusing on capital markets transactions.

Our Strategy

The key components of our strategy are to:

Grow operating margins and cash flow by leveraging our operational expertise and group synergies. We have a successful track record of improving the performance of cable and telecommunication operators across geographies. We expect to continue to grow our operating margins by focusing on cost optimization and increasing economies of scale and operational synergies as our Group develops. In addition, we also aim to reduce churn by continuously improving our service quality, bundling and subscriber satisfaction, which we expect to drive growth in our operating margin. Furthermore, we target further economies of scale in capital expenditures as our Group expands and our bargaining power increases. In addition, we believe in-market consolidation opportunities and related synergies will continue to drive our profitability and cash-flow expansion. For example, we believe our recent acquisition of Outremer Telecom (a mobile and fixed-line player in the French Overseas Territories) and the acquisitions of Tricom and ODO (cable and mobile operators in the Dominican Republic) are, and the acquisition of PT Portugal following the PT Portugal Acquisition will be, complementary to our existing cable operations in these geographies and allow us to generate synergies. In Portugal, we expect the PT Portugal Acquisition will result in the realization of operational synergies in the following areas: telecommunication equipment procurement, content procurement, maintenance spend, customer care, IT, workflow processes, marketing and product offering. In addition, the high-quality, fiber based network we will acquire as part of the PT Portugal Acquisition could reduce the need for fiber roll-out expenditures currently planned by Altice Portugal.

Management estimates that the total annual cost synergies impacting EBITDA and total annual synergies impacting capital expenditures, which are expected to result in the medium term from the PT Portugal Acquisition to be approximately €100 million and €40 million respectively. However, this synergies estimate is based on a number of assumptions made in reliance on the information available to us and management's judgments based on such information. The assumptions used in estimating synergies are inherently uncertain and are subject to a wide variety of significant business, economic, and competitive risks and uncertainties that could cause actual results to differ materially from those contained in the synergies benefit estimates.

In the Dominican Republic, in March 2014, we completed the acquisition of Tricom, a cable and fixed line as well as mobile services provider, and in April 2014 we completed the ODO Acquisition, a mobile and wireless broadband internet services provider, which we believe will enable us to build an integrated fixed line and mobile infrastructure, and provide us with substantial cross sell and up sell opportunities. In addition, we believe our recent acquisition of Outremer Telecom (a mobile and fixed line player in the French Overseas Territories) will enable us to benefit from cross selling and up selling opportunities between our cable, DSL and mobile customer bases. Following these acquisitions, we have realized certain operating expense and capital expenditure savings and, together with the synergies expected in the French Overseas Territories and our existing Portuguese operations, expect to benefit from approximately €15 million of incremental total annual cost synergies impacting EBITDA as a result of these transactions.

Further increase our multiple-play penetration and ARPU by providing new and existing customers with additional products and services, including attractive mobile products wherever profitable. We believe that our state-of-the-art cable and fiber networks across our markets provide us with a strong technological infrastructure for delivering high-quality television, higher speed internet and triple and, where permitted, quadruple-play services at attractive prices. We believe that fixed network leadership, operational excellence and multiple-play strategy are key success factors in our end markets. We have successfully increased triple-play penetration, as reflected by the growing number of RGUs per customer relationship across geographies from 2.0x as of December 31, 2012 to 2.1x as of September 30, 2014 (without giving effect to the PT Portugal Acquisition). Our strategy is to continue to increase our multiple-play customer penetration by attracting new customers and cross-selling mobile services to our existing cable- and/or FTTH-based customers in the countries in which we offer those services. We also plan to leverage up-selling opportunities to maximize ARPU by increasing penetration of certain services, such as higher speed broadband internet, premium content

or value added interactive services, such as VoD and PVR. We believe that we will be able to convert some of our existing xDSL customer relationships into cable-based customer relationships with additional services and potentially higher ARPU. Following the PT Portugal Acquisition, we believe we have the potential to increase penetration of both fixed and mobile services in Portugal, by leveraging the PT Portugal Group's state-of-the-art FTTH broadband network and 4G mobile network, and its innovative triple-play and quadruple-play bundles. The PT Portugal Group's mobile strategy will focus on driving growth through mobile data offers based on its high quality network, delivering best in class coverage, capacity and quality of service to customers. The PT Portugal Group is focused on increasing smartphone penetration through a broad portfolio of handsets, and simplification of tariff plans to reinforce its post-paid value proposition and consequently encourage customer migration from prepaid to post-paid plans, which typically results in lower churn.

Leverage our networks to address new growth opportunities including B2B and mobility. We believe that our dense cable/FTTH network infrastructures supported by fiber backbones will position us ideally to service new demand from corporate customers and to benefit from the convergence of fixed-mobile usage without significant capital investment. We aim to leverage our well-invested infrastructures to offer tailored data solutions and capture profitable growth in these markets, thereby maximizing the return on our network assets. As the B2B telecommunications market shifts to next generation services, including IP VPN, hosting or cloud services, which are more bandwidth-intensive and complex, we will look to expand opportunistically in the B2B businesses, which offer important economies of scale and synergies with our B2C operations. In addition, as mobile internet traffic is expected to grow at an average 68% growth rate between 2012 and 2017 (according to a Cisco VNI 2013 study) primarily driven by development of smart devices supporting multiple wireless technologies, we believe our high capacity backbone will be a differentiating factor as it enables us to offer a compelling backhaul offload offering at limited cost to MNOs. In Portugal, following the PT Portugal Acquisition, we will benefit from a leading enterprise telecom infrastructure (including one of the largest data centers in the world) and strong customer relationships, as well as from the PT Portugal Group's number one mobile telecom position with its 4G mobile network and superior scale as a mobile operator. We believe we can further grow this business by leveraging know-how between our Portuguese businesses and implementing best practices from the broader Altice Group.

Generate value through disciplined acquisition strategy and proven integration capabilities. We deploy capital opportunistically across our portfolio through value enhancing acquisitions with the aim of generating strong cash flow and operational synergies in the cable and telecommunication sector. We target operators with what we believe to be quality networks in attractive markets from an economic, competitive and regulatory standpoint and seek to create value at the acquired businesses by implementing operational improvements and leveraging economies of scale, as well as pursuing in-market consolidation and attractive diversification with FTTH, B2B, DSL and mobile add-on opportunities. Our acquisition strategy also benefits from our flexible capital structure, which features no material near term maturities and allows us to make investments. The terms of the agreements governing our debt have historically allowed us to execute our acquisition strategy enabling us to be agile and opportunistic in a fast evolving environment. We have a strong track record of integrating acquired businesses having completed over ten acquisitions in the last three years. The PT Portugal Acquisition represents a further meaningful extension of this strategy and we believe will enable us to realize value through significant expected operational synergies.

Recent Developments

PT Portugal Acquisition

On December 9, 2014, Altice S.A., through its subsidiary Altice Portugal, entered into an agreement with Oi S.A. (the "PT Portugal Acquisition Agreement") relating to the purchase of all of the outstanding equity interests in PT Portugal (the "PT Portugal Acquisition") for an enterprise value of €7,400 million, as adjusted for estimated net post retirement benefit obligations post tax of €957 million and other non financial debt purchase price adjustments (including working capital adjustments and certain tax liabilities) of €339 million (price paid will be after deduction of net financial debt at closing and difference to normative level of working capital, as defined in the PT Portugal Acquisition Agreement) payable in cash upon completion of the PT Portugal Acquisition, which includes an earn out of €500 million, payable in the event the consolidated revenues of the PT Portugal Group for any financial year between 2015 to 2019 achieves a specified target. In order for PT Portugal to exceed such specified revenue target by the end of the specified period, its revenue growth will need to materially exceed the best-in-class compound annual revenue growth rate currently expected by the market from incumbent telecommunications companies in Europe. Prior to the Completion Date, Oi S.A. shall cause a reorganization of PT Portugal and its subsidiaries to be completed (the "Carve Out Reorganization") so that, among other things, upon the completion of the PT Portugal Acquisition, PT Portugal shall no longer own any interests in the entities and assets, or in the financing vehicles that are currently part of the PT Portugal perimeter. In particular, the commercial paper and any other securities issued by Rio Forte Investments S.A. shall not be included in the assets comprising the PT Portugal Group.

The consummation of the PT Portugal Acquisition is subject to certain conditions, including merger control from the European Commission (or from the Portuguese Competition Authority, under the referral mechanism set forth in the EU merger control rules) and relevant authorizations and clearances from the Portuguese ISP (*Instituto de Seguros de Portugal*).

The PT Portugal Acquisition is expected to be completed in the second quarter in 2015.

Merger between PTC and Meo, S.A.

On December 29, 2014, Meo, S.A. and PTC, the two most material subsidiaries in the PT Portugal Group, merged, with PTC as the surviving entity. PTC was renamed MEO—Serviços de Comunicações e Multimédia, S.A. (“PT OpCo”). For the avoidance of doubt, when we refer to “PTC” and “Meo, S.A.” in a historical context, we are referring to PTC and Meo, S.A. as separate entities prior to the merger.

Coditel

Proposed Merger

It is intended that each of Coditel Holding Lux S.à r.l. and Coditel Holding Lux II S.à r.l. will merge with and into Coditel Holding sometime in the first quarter of 2015, with Coditel Holding S.A. being the surviving entity once such merger has taken effect. Once such merger has taken effect, we expect to cause Coditel Holding to accede as an additional guarantor in respect of indebtedness of the Senior Secured Notes Issuer and the Senior Notes Issuer (including the New Notes).

Refinancing of the Existing Coditel Mezzanine Facility

The Existing Coditel Mezzanine Facility was refinanced on December 2, 2014 by €124 million (equivalent) of borrowings under the Existing Revolving Credit Facilities. We drew all of the 2013 Revolving Credit Facility and \$56 million of the 2012 Revolving Credit Facility to repay the Existing Coditel Mezzanine Facility. On January 27, 2015, we repaid the \$56 million outstanding under the 2012 Revolving Credit Facility. As of the date hereof, all of the 2013 Revolving Credit Facility has been drawn.

Altice Group

Our Controlling Shareholder

Founded by telecom entrepreneur Patrick Drahi, Altice S.A. is the parent company of the Altice Group. Altice S.A. has significant experience identifying acquisition opportunities, structuring, financing and managing investments in the telecommunications industry, advising cable operators worldwide and creating value through operational excellence. Through Altice International and its subsidiaries, the Altice Group has developed a strong presence in Israel, Portugal, Belgium, Luxembourg, Switzerland, the Dominican Republic and the French Overseas Territories in the Indian Ocean region. In addition, the Altice Group has consolidated the cable and telecom market in France as a result of the roll up of the French cable and telecom market into the Numericable Group and Completel and, following the completion of the acquisition by the Numericable Group of SFR in November 2014, SFR. Since February 2014, Altice S.A. has consolidated results of operations of the Numericable Group with results of operations of the Altice Restricted Group in the financial statements of a parent entity of the Altice Group. Notwithstanding such consolidation, each of the Altice Restricted Group and the Numericable Group will continue to be financed on a stand-alone basis and the Altice Restricted Group will continue to provide separate financial statements and other required periodic reports to holders of its indebtedness.

The Issuers

The Senior Secured Notes Issuer is a public limited liability company (*société anonyme*) incorporated under the laws of the Grand Duchy of Luxembourg, having its registered office at 3, Boulevard Royal, L-2449 Luxembourg and registered with the Luxembourg Trade and Companies Register under number B171162. The Senior Notes Issuer is a public limited liability company (*société anonyme*) incorporated under the laws of the Grand Duchy of Luxembourg, having its registered office at 3, Boulevard Royal, L-2449 Luxembourg and registered with the Luxembourg Trade and Companies Register under number B171151. The Issuers’ business operations include only managing the financing activities of the Group. The Senior Secured Notes Issuer’s ability to pay principal, interest and premium, if any, on the New Senior Secured Notes and the Senior Notes Issuer’s ability to pay principal, interest and premium, if any, on the New Senior Notes, are dependent, in large part, upon payments received from the Group pursuant to the Pledged Proceeds Notes and the Senior Notes Proceeds Loans, as applicable. See “*Risk Factors—Risks Relating to the New Notes and the Structure—The Issuers are special purpose vehicle companies with limited assets other than their respective interests in the Existing*

Senior Notes Proceeds Loans, New Senior Notes Proceeds Loan, AH Proceeds Loan (as defined below), New AH Proceeds Loan, the Cool Proceeds Note, the 2012 Acquisition Note and the HOT Refinancing Note and escrowed funds and are dependent upon cash from Altice International and its subsidiaries to meet its obligations” and “Corporate and Financing Structure” for more information.

SIMPLIFIED CORPORATE AND FINANCING STRUCTURE

The following diagram summarizes our expected corporate and financing structure after giving effect to the New Transactions. For further details, see “Corporate and Financing Structure”. The following is provided for indicative and illustration purposes only and should be read in conjunction with the information contained elsewhere in these Listing Particulars. For a summary of the debt obligations referred to in the following diagram, see “Description of Senior Secured Notes”, “Description of Senior Notes” and “Description of Other Indebtedness”.

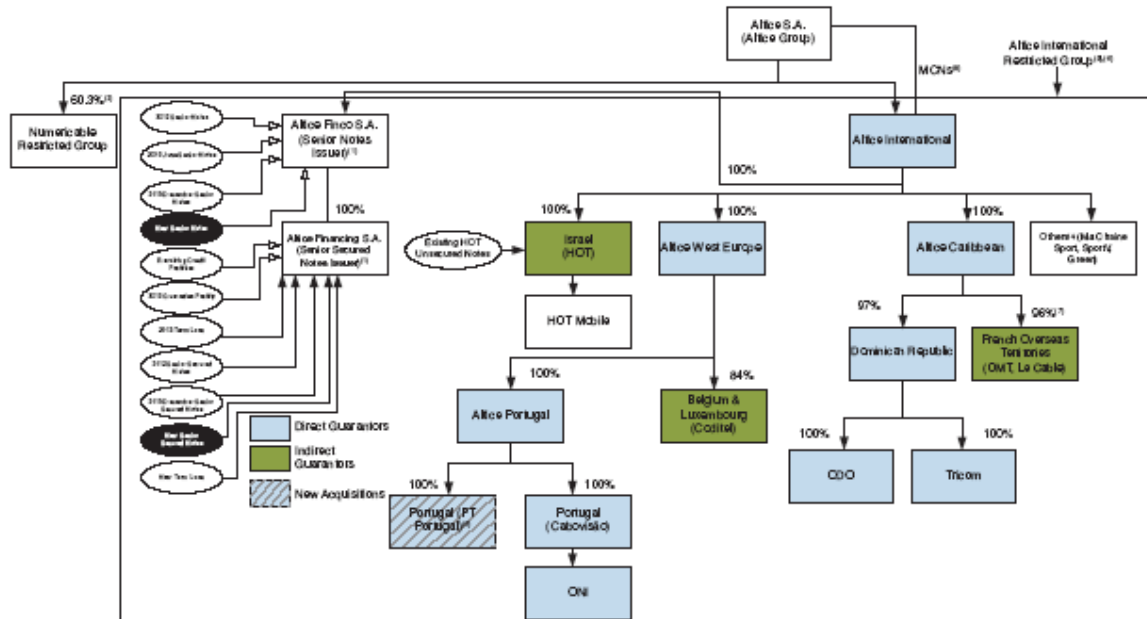

- (1) In connection with the Transactions, the Senior Notes Issuer has issued \$385 million in aggregate principal amount of the New Senior Notes. The New Senior Notes are senior obligations of the Senior Notes Issuer. In connection with the Transactions, the Senior Secured Notes Issuer has issued €500 million in aggregate principal amount of the Euro Senior Secured Notes and \$2,060 million in aggregate principal amount of the Dollar Senior Secured Notes. The New Senior Secured Notes are senior secured obligations of the Senior Secured Notes Issuer.

Pending satisfaction of the conditions to the release of the escrow proceeds as described in “Description of Notes—Escrow of Proceeds; Special Mandatory Redemption”, the Initial Purchasers deposited the gross proceeds from the offering of the Notes into segregated escrow accounts for the benefit of the holders of the Notes. The escrow release conditions will be deemed to have been satisfied upon the delivery of an officer’s certificate (the “Escrow Release Certificate”) by the Issuer to the Escrow Agent stating that, among other things, the PT Portugal Acquisition Agreement shall not have been modified, amended or waived in any respect that is material and adverse to the holders of the Notes (subject to certain exceptions), the PT Portugal Acquisition Agreement remains in full force and effect and no insolvency related events have occurred with respect to Altice International, the Senior Secured Notes Issuer (in the case of the Senior Secured Notes Escrow Agreement) and the Senior Notes Issuer (in the case of the Senior Secured Notes Escrow Agreement). If the conditions for the release of escrow proceeds are not satisfied prior to June 9, 2016 or upon the occurrence of certain other events, the Notes will be subject to a special mandatory redemption at 100% of the principal amount plus accrued and unpaid interest and additional amounts, if any. The Indentures require the Senior Secured Notes Issuer (in the case of the Senior Secured Notes Indenture) and the Senior Notes Issuer (in the case of the Senior Notes Indenture) to cause the consummation of the PT Portugal Acquisition promptly upon release of the proceeds from the Escrow Accounts (other than a release for purposes of investing the escrow proceeds in accordance with the terms of the Senior Secured Notes Escrow Agreement or the Senior Notes Escrow Agreement (as applicable)). Prior to the Completion Date, the New Senior Secured Notes are not guaranteed, but are secured by a first-ranking pledge over the assets in the Senior Secured Notes Escrow Accounts and the Senior Secured Notes Issuer’s rights under the Senior Secured Notes Escrow Agreement. Prior to the Completion Date, the New Senior Notes are not guaranteed, but are secured by a first-ranking pledge over the assets in the Senior Notes Escrow Accounts and the Senior Secured Notes Issuer’s rights under the Senior Notes Escrow Agreement.

- (2) Altice S.A. currently holds 60.3% of the voting shares of Numericable Group.
- (3) The Restricted Group for the New Senior Secured Notes does not include the Senior Notes Issuer.
- (4) Includes Green Datacenter and Auberimmo which are designated as unrestricted subsidiaries.
- (5) The New Notes will be guaranteed by PT Portugal and PT OpCo, with the latter entity contributing to over 97% of the revenues, 95% of the EBITDA and 97% of the total assets of PT Portugal and its subsidiaries (taken as a whole) that will be acquired in the PT Portugal Acquisition.
- (6) Substantially all of our third-party indebtedness within the Restricted Group is at the Senior Notes Issuer and the Senior Secured Notes Issuer except for the finance leases and the Existing HOT Unsecured Notes.

- (7) Substantially all of the remaining share capital is held by our Parent, Altice S.A.
- (8) It is expected that Altice S.A. will contribute the proceeds of the New ASA Senior Notes to Altice International in exchange for €2,055 million (equivalent) mandatory convertible notes to be issued by Altice International and to be subscribed by Altice S.A., and Altice International will, in turn, contribute such proceeds to Altice Holdings.

The following is a summary of certain aspects of the Guarantees and Collateral related to the New Senior Secured Notes. The Guarantees and Collateral related to the New Senior Secured Notes are complex and subject to significant exceptions and qualifications. The following summary is not a complete description of the Guarantees and Collateral related to the New Senior Secured Notes and is qualified in its entirety by reference to the more detailed descriptions set out in “Description of Senior Secured Notes” and “Corporate and Financing Structure”. See also, “Risk Factors—Risk Relating to the New Notes and the Structure”. For a description of the Guarantees and Collateral related to the New Senior Notes, see “Description of Senior Notes” and “Corporate and Financing Structure”.

New Senior Secured Notes

Company	% Ownership by Altice International	Guarantor(s)	Direct Share Pledges	Additional Security/Proceeds Loans/Other
Altice International and certain intermediate holding companies	100% ⁽¹⁾	Yes ⁽²⁾	First-ranking pledges over all of the share capital of Altice Holdings, Altice West Europe, Altice Caribbean, Cool Holdings, SPV1, Altice Bahamas and ABO ⁽⁴⁾	First-ranking pledges over substantially all of the assets of such companies, including share pledges of Restricted Subsidiaries owned by such companies and all intercompany loans from Altice Holdings to other members of the Restricted Group and certain other intercompany debt instruments held by Altice Holdings and certain other members of the Restricted Group, including intercompany loans and debt interests described below as well as €48 million of ABO Proceeds Loans.
Senior Notes Issuer ⁽³⁾	100%	No	N/A	First-ranking pledges over all Senior Notes Proceeds Loans from the Senior Notes Issuer to the Senior Secured Notes Issuer.
Senior Secured Notes Issuer	100%	N/A	First-ranking pledge over all of the share capital of the Senior Secured Notes Issuer	First-ranking pledge over the bank accounts and all receivables of the Senior Secured Notes Issuer, including the Senior Secured Notes Issuer Pledged Proceeds Notes to Altice Holding, Cool Holding, SPV1 and HOT.
Portugal (PT Portugal and certain of its subsidiaries)	100%	PT Portugal and PT OpCo: Yes ⁽²⁾	First-ranking pledges over all of the share capital of PT Portugal, PT OpCo, PT Cloud and PT Móveis	Altice Portugal will assign all of its claims and rights under the acquisition agreement in connection with the PT Portugal Acquisition.
Israel (HOT)	100% ⁽⁶⁾	No (see Additional Security/Proceeds Loans/Other)	First-ranking pledge over all of the share capital of HOT	First-ranking pledge over NIS 1.9 billion (€408.5 million) secured proceeds loan from the Senior Secured Notes Issuer to HOT, which is secured by security interests over all of HOT’s material assets (except licenses and end user equipment and assets of HOT Mobile) including network, bank accounts and receivables.
Dominican Republic (ODO/Tricom)	Orange: 97% Tricom: 97%	Yes	First-ranking pledge over the share capital of ODO and Tricom owned indirectly by Altice International	First-ranking share pledges over operating companies (effective upon approval by Indotel) and all material assets (other than licenses and real estate assets valued at less than €5 million).
Portugal (Altice Portugal, Cabovisão and ONI)	100%	Altice Portugal: Yes Cabovisão: Yes ⁽²⁾ ONI: Yes ⁽²⁾	None (see Additional Security/Proceeds Loans/Other)	The New Senior Secured Notes will not be secured by the share capital of Altice Portugal or any assets of Altice Portugal, Cabovisão or ONI. Pursuant to the Intercreditor Agreement, the holders of the New Senior Secured Notes will share on a <i>pari passu</i> basis in the proceeds of any enforcement by the other senior secured creditors of the Senior Secured Notes Issuer of their security interests over the following property and assets: — all material assets of Altice Portugal and Cabovisão (including bank accounts of Cabovisão and shareholders’ credit of Altice Portugal, a floating charge over the business as a going concern of Cabovisão) ⁽²⁾ ; — certain assets and rights of ONI and its wholly owned subsidiaries (including shareholders’ credits, certain bank accounts and receivables under certain telecommunication contracts) ⁽²⁾ ; — pledge over €24 million Original Cabovisão Proceeds Notes ⁽²⁾ ; — first-ranking pledge over Altice Holdings’ securities account where the €22.2 million of New Cabovisão Proceeds Notes and €47.5 million of Onitelem Proceeds Notes are registered.
Belgium and Luxembourg (Coditel)	84%	No (see Additional Security/Proceeds Loans/Other)	None (see Additional Security/Proceeds Loans/Other)	No direct security over the assets of Coditel Belgium and Coditel Luxembourg. First-ranking pledge over €131 million of loans under the Coditel Senior Facility, which in certain turn are secured by first-ranking security interests over the share capital of Coditel Holding and Coditel Belgium, receivables and bank accounts of Coditel Holdings, trade insurance, inter group and other receivables and bank accounts of Coditel Luxembourg, including a secured intercompany loan (€106 million) made by Coditel Luxembourg to Coditel Belgium that is secured over certain assets of Coditel Belgium.
French Overseas Territories (Le Cable and OMT)	96% ⁽⁵⁾	No (see Additional Security/Proceeds Loans/Other)	None (see Additional Security/Proceeds Loans/Other)	No direct security over the assets of OMT and Le Cable. First-ranking pledge over €355 million of Outremer Proceeds Loans and €22 million of Le Cable Proceeds Loans, which in turn are secured by first-ranking security interests over substantially all of the assets of OMT or Le Cable, as applicable, including share pledges and receivables.
Other (Green, Ma Chaîne Sport and SportV)	97%-100%	Green: Yes Others: No	None	First-ranking assignment over bank accounts, intragroup claims and receivables of Green. Pursuant to the Intercreditor Agreement, the holders of the New Senior Secured Notes will

share on a *pari passu* basis in the proceeds of any enforcement by the other senior secured creditors of the Senior Secured Notes Issuer of their security interests over the capital stock of Green.

No security over assets or shares of Ma Chaîne Sport and SportV.

-
- (1) Other than Altice International.
 - (2) Subject to the Aggregate Portuguese Security and Guarantee Limit (€95 million in the case of Altice Portugal and Cabovisão, € 45.8 million in the case of ONI and up to €4.6344 billion in the case of PT Portugal and €968.4 million in the case of PT OpCo).
 - (3) Excluded from the Restricted Group for purposes of the Senior Secured Debt.
 - (4) It is expected that ABO will be merged into Altice West Europe in the near term.
 - (5) All of the remaining share capital is held by our parent, Altice S.A.
 - (6) Excludes the HOT Minority Shareholder Call Options. For further details, see “*Description of Our Business—Material Contracts—Certain Shareholder Arrangements—HOT Minority Shareholder Agreements*”.

THE OFFERING

The summary below describes the principal terms of the New Notes. Certain of the terms and conditions described below are subject to important limitations and exceptions. The “Description of Senior Secured Notes” and “Description of Senior Notes” sections of these Listing Particulars contain a more detailed description of the terms and conditions of the New Notes, including the definitions of certain terms used in this summary.

Issuers

Senior Secured Notes Issuer..... Altice Financing S.A., a public limited liability company incorporated under the laws of the Luxembourg, having its registered office at 3, boulevard Royal, L-2449 Luxembourg, registered with the Luxembourg Trade and Companies’ Register under number B 171.162.

Senior Notes Issuer..... Altice Finco S.A., a public limited liability company incorporated under the laws of the Luxembourg, having its registered office at 3, boulevard Royal, L-2449 Luxembourg, registered with the Luxembourg Trade and Companies’ Register under number B 171.151.

Notes Offered

New Senior Secured Notes..... \$2,060 million aggregate principal amount of 6⁵/₈% senior secured notes due 2023 (the “Dollar Senior Secured Notes”).

€500 million aggregate principal amount of 5¹/₄% senior secured notes due 2023 (the “Euro Senior Secured Notes” and together with the Dollar Senior Secured Notes, the “New Senior Secured Notes”).

New Senior Notes..... \$385 million aggregate principal amount of 7⁵/₈% senior notes due 2025 (the “New Senior Notes”).

Maturity Date

New Senior Secured Notes..... February 15, 2023

New Senior Notes..... February 15, 2025

Interest

Dollar Senior Secured Notes..... 6.625%

Euro Senior Secured Notes 5.250%

New Senior Notes..... 7.625%

Interest Payment Dates..... Semi-annually in cash in arrears on each April 1 and October 1, commencing October 1, 2015. Interest will accrue from the Issue Date.

Denomination The Dollar Senior Secured Notes and the New Senior Notes are in denominations of \$200,000 and any integral multiples of \$1,000 above \$200,000. Dollar Senior Secured Notes and New Senior Notes in denominations of less than \$200,000 are not available. The Euro Senior Secured Notes are in denominations of €100,000 and any integral multiples of €1,000 in excess of €100,000. Euro Senior Secured Notes in denominations of less than €100,000 are not available.

Issue Price

Dollar Senior Secured Notes..... 100.000% plus accrued interest, if any, from the Issue Date.

Euro Senior Secured Notes 100.000% plus accrued interest, if any, from the Issue Date.

New Senior Notes..... 100.000% plus accrued interest, if any, from the Issue Date.

Ranking of the Notes

New Senior Secured Notes..... The New Senior Secured Notes:

- are general obligations of the Senior Secured Notes Issuer;
- will be secured as set forth under “—Security”;
- rank pari passu in right of payment with any existing or future indebtedness of the Senior Secured Notes Issuer that is not subordinated in right of payment to the New Senior Secured Notes;
- rank senior in right of payment to any existing or future indebtedness of the Senior Secured Notes Issuer that is expressly subordinated in right of payment to the New Senior Secured Notes;
- will be effectively subordinated to any existing or future indebtedness of the Senior Secured Notes Issuer that is secured by property or assets that do not secure the New Senior Secured Notes, to the extent of the value of the property and assets securing such Indebtedness; and
- will be effectively subordinated to the indebtedness and other obligations of any member of the Group that does not guarantee the New Senior Secured Notes.

New Senior Notes..... The New Senior Notes:

- are general obligations of the Senior Notes Issuer;
- will be secured as set forth under “—Security”;

- rank pari passu in right of payment with any existing or future indebtedness of the Senior Notes Issuer that is not subordinated in right of payment to the New Senior Notes;
- rank senior in right of payment to any existing or future indebtedness of the Senior Notes Issuer that is expressly subordinated in right of payment to the New Senior Notes;
- will be effectively subordinated to any existing or future indebtedness of the Senior Notes Issuer that is secured by property or assets that do not secure the New Senior Notes, to the extent of the value of the property and assets securing such Indebtedness; and
- will be effectively subordinated to the indebtedness and other obligations of any member of the Group that does not guarantee the New Senior Notes.

Guarantees

New Senior Secured Notes..... The New Senior Secured Notes were not guaranteed on the Issue Date. On the Completion Date, the New Senior Secured Notes will be guaranteed on a senior secured basis (the “Senior Secured Notes Guarantees”) by Altice International, Cool Holding, SPV1, Altice Holdings, Altice West Europe, Altice Caribbean, Green, Altice Portugal, Cabovisão, Altice Bahamas, Tricom, Global Interlink Ltd., ODO, Winreason, ONI S.G.P.S., Onitelecom and Knewon (collectively, the “Existing Guarantors”) and within 90 days following the PT Portugal Acquisition, PT Portugal and PT OpCo (the “Acquired Guarantors” and, together with the Existing Guarantors, the “Senior Secured Notes Guarantors”). The guarantees of Altice Portugal, Cabovisão, Winreason, ONI S.G.P.S., Onitelecom, Knewon, PT Portugal and PT OpCo will be subject to the Aggregate Portuguese Security and Guarantee Limit, as applicable.

New Senior Notes..... The New Senior Notes were not guaranteed on the Issue Date. On the Completion Date, the New Senior Notes will be guaranteed on a senior subordinated basis (the “Senior Notes Guarantees” and, together with the Senior Secured Notes Guarantees, the “Guarantees”) by the Senior Secured Notes Issuer and the Existing Guarantors and within 90 days following the PT Portugal Acquisition, the Acquired Guarantors (such guarantors, collectively, the “Senior Notes Guarantors” and, together with the Senior Secured Notes Guarantors, the “Guarantors”). The guarantees of Altice Portugal, Cabovisão, Winreason, ONI S.G.P.S., Onitelecom, Knewon, PT Portugal and PT OpCo will be subject to the Aggregate Portuguese Security and Guarantee Limit, as applicable.

Ranking of the Guarantees

New Senior Secured Notes..... Each Senior Secured Notes Guarantee will:

- be a general obligation of the relevant Senior Secured Notes Guarantor;
- rank pari passu in right of payment with any existing and future indebtedness of the relevant Senior Secured Notes Guarantor that is not subordinated in right of payment to such Senior Secured Notes Guarantor’s Senior Secured Notes Guarantee;
- rank senior in right of payment to all existing and future indebtedness of the relevant Senior Secured Notes Guarantor that is expressly subordinated in right of payment to such Senior Secured Notes Guarantor’s Senior Secured Notes Guarantee;
- be effectively subordinated to any existing and future indebtedness of the relevant Senior Secured Notes Guarantor that is secured by property or assets that do not secure such Senior Secured Notes Guarantor’s Senior Secured Notes Guarantee, to the extent of the value of the property and assets securing such indebtedness; and
- be effectively subordinated to the indebtedness and other obligations of any member of the Group that does not guarantee the New Senior Secured Notes.

The Senior Secured Notes Guarantees will be subject to the terms of the Intercreditor Agreement. See “*Description of Other Indebtedness—The Intercreditor Agreement*”.

The Senior Secured Notes Guarantees will be subject to release under certain circumstances. See “*Description of Senior Secured Notes—The Note Guarantees*”.

New Senior Notes..... Each Senior Notes Guarantee will:

- be a senior subordinated obligation of the relevant Senior Notes Guarantor;

- be subordinated in right of payment to any existing and future senior indebtedness of the relevant Senior Notes Guarantor, including that Senior Notes Guarantor’s guarantee of the New Senior Secured Notes, the Existing Revolving Credit Facilities, the New Revolving Credit Facilities, the Existing Senior Credit Facility and the New Senior Credit Facility;
- rank pari passu in right of payment to all existing and future senior subordinated indebtedness of the relevant Senior Notes Guarantor;
- rank senior in right of payment to all existing and future indebtedness of the relevant Senior Notes Guarantor that is expressly subordinated in right of payment to such Senior Notes Guarantor’s Senior Notes Guarantee;
- be effectively subordinated to any existing and future indebtedness of the relevant Senior Notes Guarantor that is secured by property or assets that do not secure such Senior Notes Guarantor’s Senior Notes Guarantee, to the extent of the value of the property and assets securing such indebtedness; and
- be effectively subordinated to the indebtedness and other obligations of any member of the Group that does not guarantee the New Senior Notes.

The Senior Notes Guarantees will be subject to the terms of the Intercreditor Agreement, including payment blockage upon a senior default and standstills on enforcement. See “*Description of Other Indebtedness—The Intercreditor Agreement*”.

The Senior Notes Guarantees will be subject to release under certain circumstances. See “*Description of Senior Notes—The Note Guarantees*”.

Security

New Senior Secured Notes.....

As of the Issue Date, the New Senior Secured Notes were secured by a security interest over the rights of the Senior Secured Notes Escrow Agent under the Senior Secured Notes Escrow Agreement and the assets in the Senior Secured Notes Escrow Accounts.

On the Completion Date, the New Senior Secured Notes will be secured (i) on the date of release from the applicable Senior Secured Notes Escrow Accounts, by (A) a first ranking pledge over the receivables under the AWE Proceeds Loan and (B) an assignment of claims and rights under the acquisition agreement signed by Altice Portugal in connection with the PT Portugal Acquisition, (ii) within 10 Business Days of the PT Portugal Acquisition, by a first ranking pledge over all of the shares of PT Portugal and (iii) within 90 days following the PT Portugal Acquisition, by first ranking pledges over all of the shares of PT OpCo, PT Cloud and PT Móveis. Security granted by Altice Portugal, PT Portugal and PT OpCo will be subject to the Aggregate Portuguese Security and Guarantee Limit. The New Senior Secured Notes, as Senior Secured Debt, will also be secured by:

- first-ranking pledges over all of the share capital of the Senior Secured Notes Issuer, all of the share capital of the Existing Guarantors (other than Altice International, Green, Altice Portugal, Cabovisão, Winreason, ONI S.G.P.S., Onitelecom and Knewon) (the share pledges over the share capital of ODO, Global Interlink Ltd. and Tricom will be effective upon approval by Indotel), ABO (which is expected to be merged into Altice West Europe in the near term) and the capital stock of HOT;
- a first-ranking pledge over the bank accounts and all receivables of the Senior Secured Notes Issuer, including the Senior Secured Notes Issuer Pledged Proceeds Notes;
- subject to certain exceptions, first-ranking pledges (or assignments, as applicable) over all of the material assets of each Existing Guarantor (other than Altice Portugal, Cabovisão, Winreason, ONI S.G.P.S., Onitelecom and Knewon);
- a first-ranking pledge over the Senior Notes Proceeds Loans;
- a first-ranking pledge over the Cool Shareholder Loan; and
- a first-ranking pledge over the Covenant Party Pledged Proceeds Loans (other than the Onitelecom Proceeds Notes and the Cabovisão Proceeds Notes) (collectively the security described under this paragraph, the “Senior Secured Collateral”).

Pursuant to the Intercreditor Agreement, the holders of the New Senior Secured Notes will share in the proceeds of enforcement of the Cabovisão Security, the ONI Security and the PT Portugal Security up to an amount equal to the Aggregate Portuguese Security and Guarantee Limit, as applicable.

New Senior Notes.....	<p>The Senior Secured Collateral securing the New Senior Secured Notes and the Senior Secured Notes Guarantees also secure, on a first-ranking basis, the obligations of the Senior Secured Notes Issuer and Senior Secured Notes Guarantors under the Senior Secured Debt.</p> <p>As of the Issue Date, the New Senior Notes were secured by a security interest over the rights of the Senior Notes Escrow Agent under the Senior Notes Escrow Agreement and the assets in the Senior Notes Escrow Account.</p> <p>On the Completion Date, the New Senior Notes will be secured by:</p> <ul style="list-style-type: none"> (i) a first-ranking pledge over all of the share capital of the Senior Notes Issuer; (ii) second-ranking pledges over all of the share capital of the Senior Secured Notes Issuer, Cool Holding and Altice Holdings; (iii) second-ranking pledges over the Senior Notes Proceeds Loans; and (iv) a second-ranking pledge over the Cool Shareholder Loan (collectively, the “Senior Notes Collateral” and, together with the Senior Secured Collateral, the “Collateral”). <p>The Senior Notes Collateral securing the New Senior Notes and the Senior Notes Guarantees also secure, on a first-ranking basis, the obligations of the Senior Secured Notes Issuer and the Existing Guarantors and, following the PT Portugal Acquisition, the applicable Acquired Guarantors under the New Senior Secured Notes and the Senior Secured Debt (other than the pledge over all of the share capital of the Senior Notes Issuer), and on a pari passu basis, the obligations of the Senior Notes Issuers and the Senior Notes Guarantors under the Existing Senior Notes.</p>
Escrow of Proceeds; Special Mandatory Redemption.....	<p>The Initial Purchasers, concurrently with the closing of the offering of the New Notes on the Issue Date, (i) deposited the gross proceeds of the New Senior Secured Notes into segregated escrow accounts (the “Senior Secured Notes Escrow Accounts”) pursuant to the terms of an escrow deed (the “Senior Secured Notes Escrow Agreement”) and (ii) deposited the proceeds of the New Senior Notes into a segregated escrow account (the “Senior Notes Escrow Account”) pursuant to the terms of the terms of an escrow deed (the “Senior Notes Escrow Agreement”). The Senior Secured Notes Escrow Accounts are controlled by the Senior Secured Notes Escrow Agent, and pledged on a first ranking basis in favor of the Trustee on behalf of the holders of the New Senior Secured Notes. The Senior Notes Escrow Account is controlled by Senior Secured Notes Escrow Agent, and pledged on a first ranking basis in favor of the Trustee on behalf of the holders of the New Senior Notes.</p> <p>If the conditions to the release of the escrow proceeds as set forth in “<i>Description of Senior Secured Notes—Escrow of Proceeds; Special Mandatory Redemption</i>” and “<i>Description of Senior Notes—Escrow of Proceeds; Special Mandatory Redemption</i>” are not satisfied prior to June 9, 2016 or upon the occurrence of certain other events, the applicable New Notes will be subject to a special mandatory redemption at a price equal to 100% of the initial issue price of each such New Note plus accrued and unpaid interest and additional amounts, if any, from the Issue Date. See “<i>Description of Senior Secured Notes—Escrow of Proceeds; Special Mandatory Redemption</i>” and “<i>Description of Senior Notes—Escrow of Proceeds; Special Mandatory Redemption</i>”.</p>
Change of Control	<p>The Indentures require the Senior Secured Notes Issuer (in the case of the Senior Secured Notes Indenture) and the Senior Notes Issuer (in the case of the Senior Notes Indenture) to consummate the PT Portugal Acquisition promptly upon release of the proceeds from the Escrow Accounts (other than a release for purposes of investing the escrow proceeds in accordance with the Senior Secured Notes Escrow Agreement or the Senior Notes Escrow Agreement (as applicable)).</p> <p>Following a change of control triggering event as defined in the New Senior Secured Notes Indenture at any time, the Senior Secured Notes Issuer will be required to offer to repurchase the New Senior Secured Notes at 101% of their aggregate principal amount, plus accrued and unpaid interest and additional amounts, if any, to the date of the purchase. See “<i>Description of Senior Secured Notes—Change of Control</i>”.</p> <p>Following a change of control triggering event as defined in the New Senior Notes Indenture at any time, the Senior Notes Issuer will be required to offer to repurchase the New Senior Notes at 101% of their aggregate principal amount, plus accrued and unpaid interest and additional amounts, if any, to the date of the purchase. See “<i>Description of Senior Notes—Change of Control</i>”.</p>

Subject to certain conditions, a change of control as defined in each Indenture, and therefore a change of control triggering event, shall be deemed not to have occurred as a result of the sale, lease, transfer, conveyance or other disposition in one or a series of related transactions of any assets of Altice International and its subsidiaries or PT Portugal and its Subsidiaries (including the capital stock of PT Portugal or any subsidiary of Altice International or PT Portugal) that is required pursuant to competition laws or is taken to avoid or eliminate any impediment under competition laws (including without limitation, in response to any actions initiated by a administrative, regulatory or other governmental authority or private party under competition laws). See “*Description of Senior Secured Notes—Change of Control*” and “*Description of Senior Notes—Change of Control*”.

Redemption with Minority Shareholder Option Proceeds ...

Upon certain HOT Minority Shareholder Option Exercises (as defined in “*Description of Senior Secured Notes*” and “*Description of Senior Notes*”), the Senior Secured Notes Issuer must offer to repurchase the New Senior Secured Notes and the Senior Secured Debt (and other pari passu debt) at a price equal to 103% of the principal amount plus accrued and unpaid interest and additional amounts, if any, with the net cash proceeds of such HOT Minority Shareholder Option Exercises. In the event there are any remaining net cash proceeds after the completion of such offer, the Senior Notes Issuer must offer to repurchase the New Senior Notes and the Existing Senior Notes (and other pari passu debt) at a price equal to 103% of the principal amount plus accrued and unpaid interest and additional amounts, if any, with such remaining net cash proceeds. See “*Description of Senior Secured Notes—Offer to Repurchase with Minority Shareholder Option Proceeds*” and “*Description of Senior Notes—Offer to Repurchase with Minority Shareholder Option Proceeds*”.

Optional Redemption

New Senior Secured Notes.....

Prior to February 15, 2018, the Senior Secured Notes Issuer may redeem all or a portion of the New Senior Secured Notes at a price equal to 100% of the principal amount plus a make-whole premium. The Senior Secured Notes Issuer may redeem some or all of the New Senior Secured Notes at any time on or after February 15, 2018, at a redemption price equal to their principal amount plus a premium, accrued and unpaid interest and additional amounts, if any. See “*Description of Senior Secured Notes—Optional Redemption*”.

In addition, prior to February 15, 2018, the Senior Secured Notes Issuer may redeem up to 40% of each series of the aggregate principal amount of the New Senior Secured Notes with the proceeds of certain public or private equity offerings at a redemption price equal to 106.625% of the principal amount of the Dollar Senior Secured Notes and 105.250% of the principal amount of the Euro Senior Secured Notes, plus, in each case, accrued and unpaid interest and additional amounts, if any, to the redemption date, provided that at least 60% of the original aggregate principal amount of each series of the New Senior Secured Notes remains outstanding after the redemption and the redemption occurs within 180 days after the closing of such equity offering. See “*Description of Senior Secured Notes—Optional Redemption*”.

New Senior Notes.....

Prior to February 15, 2020, the Senior Notes Issuer may redeem all or a portion of the New Senior Notes at a price equal to 100% of the principal amount plus a make-whole premium. The Senior Notes Issuer may redeem some or all of the New Senior Notes at any time on or after February 15, 2020, at a redemption price equal to their principal amount plus a premium, accrued and unpaid interest and additional amounts, if any. See “*Description of Senior Notes—Optional Redemption*”.

In addition, prior to February 15, 2018, the Senior Notes Issuer may redeem up to 40% of the aggregate principal amount of the New Senior Notes with the proceeds of certain public or private equity offerings at a redemption price equal to 107.625% of the principal amount of the New Senior Notes, plus, in each case, accrued and unpaid interest and additional amounts, if any, to the redemption date, provided that at least 60% of the original aggregate principal amount of the New Senior Notes remains outstanding after the redemption and the redemption occurs within 180 days after the closing of such equity offering. See “*Description of Senior Notes—Optional Redemption*”.

Additional Amounts; Tax

Redemption

All payments made under or in respect of the New Notes or the Guarantees will be made without withholding or deduction for any taxes, except to the extent required by law. If such withholding or deduction is required by law in any relevant tax jurisdiction, the relevant Issuer or the relevant Guarantor, as applicable, will pay additional amounts so that the net amount received by each holder is no less than that which it would have received in the absence of such withholding or deduction. See “*Description of Senior Secured Notes—Withholding Taxes*” and “*Description of Senior Notes—Withholding Taxes*”.

In the event of certain developments affecting taxation or certain other circumstances, the Senior Secured Notes Issuer or the Senior Notes Issuer, as applicable, may redeem the relevant New Notes in whole, but not in part, at any time, at a redemption price of 100% of the principal amount, plus accrued and unpaid interest, if any, and additional amounts, if any, to the date of redemption. See “*Description of Senior Secured Notes—Redemption for Changes in Withholding Taxes*” and “*Description of Senior Notes—Redemption for Changes in Withholding Taxes*”.

Certain Covenants

The Issuers has issued the New Notes under the New Indentures. The New Indentures limit, among other things, the ability of the Issuers and Altice International and its restricted subsidiaries, as applicable, to:

- incur or guarantee additional indebtedness;
- make investments or other restricted payments;
- create liens;
- sell assets and subsidiary stock;
- pay dividends or make other distributions or repurchase or redeem our capital stock or subordinated debt;
- engage in certain transactions with affiliates;
- enter into agreements that restrict the payment of dividends by subsidiaries or the repayment of intercompany loans and advances; and
- engage in mergers or consolidations.

These covenants are subject to a number of important exceptions and qualifications. For more details, see “*Description of Senior Secured Notes*” and “*Description of Senior Notes*”.

Transfer Restrictions

The New Notes have not been, and will not be, registered under the U.S. Securities Act or the securities laws of any other jurisdiction. The New Notes are subject to restrictions on transfer and may only be offered or sold in transactions that are exempt from or not subject to the registration requirements of the U.S. Securities Act. See “*Transfer Restrictions*” and “*Plan of Distribution*”.

Absence of a Public Market for the New Notes

The New Notes will be new securities for which there is currently no market. Although the Initial Purchasers have informed the Issuers that they intend to make a market in the New Notes, they are not obligated to do so and they may discontinue market making at any time without notice. Accordingly, the Issuers cannot assure you that a liquid market for the New Notes will develop or be maintained.

Use of Proceeds	The gross proceeds from the sale of the New Senior Secured Notes were deposited into the Senior Secured Notes Escrow Accounts for the benefit of the relevant holders of the New Senior Secured Notes and the Trustee and the gross proceeds from the sale of the New Senior Notes were deposited into the Senior Notes Escrow Account for the benefit of the holders of the New Senior Notes and the Trustee, in each case, pending satisfaction of the conditions to release such proceeds. On or prior to the Completion Date, the Escrow Agents will transfer to the Senior Secured Notes Issuer and the Senior Notes Issuer, as applicable, the gross proceeds from the New Senior Secured Notes and the New Senior Notes, respectively. See “ <i>Description of Senior Secured Notes—Escrow of Proceeds; Special Mandatory Redemption</i> ” and “ <i>Description of Senior Notes—Escrow of Proceeds; Special Mandatory Redemption</i> ”. Subject to the conditions to the release of the escrow proceeds as set forth in “ <i>Description of Senior Secured Notes—Escrow of Proceeds; Special Mandatory Redemption</i> ” and “ <i>Description of Senior Notes—Escrow of Proceeds; Special Mandatory Redemption</i> ”, the Senior Notes Issuer will use the proceeds of the New Senior Notes to make the New Senior Notes Proceeds Loan to the Senior Secured Notes Issuer which will in turn use amounts borrowed under the New Senior Notes Proceeds Loan, the amounts borrowed under the New Term Loan and the proceeds of the New Senior Secured Notes to consummate the New Transactions and to pay certain fees and expenses incurred in connection with the New Transactions. See “ <i>The Transactions</i> ” and “ <i>Use of Proceeds</i> ”.
Listing	Application has been made for the New Notes to be admitted to listing on the Official List of the Luxembourg Stock Exchange and to trading on the Euro MTF Market of the Luxembourg Stock Exchange. See “ <i>Description of Senior Secured Notes—Certain Covenants—Maintenance of Listing</i> ” and “ <i>Description of Senior Notes—Certain Covenants—Maintenance of Listing</i> ”.
Trustee	Deutsche Bank AG, London Branch
Principal Paying Agent and Transfer Agent	Deutsche Bank AG, London Branch
Euro Transfer Agent and Euro Registrar	Deutsche Bank Luxembourg S.A.
US Paying Agent, US Transfer Agent and US Registrar	Deutsche Bank Trust Company Americas
Security Agent	Citibank, N.A. London Branch
Governing Law	The New Indentures, the New Notes and the New Term Loan are governed by the laws of the State of New York. The security documents governing the Collateral will be governed by and construed in accordance with the laws of Luxembourg, Israel, England, Portugal, Switzerland, France, the Dominican Republic and the Bahamas, as applicable. See “ <i>Description of Senior Secured Notes—Notes Security</i> ” and “ <i>Description of Senior Notes—Notes Security</i> ”. The application of the provisions set out in Articles 86 to 94-8 of the Luxembourg law dated August 10, 1915 on commercial companies, as amended, is excluded.
Risk Factors	Please see “ <i>Risk Factors</i> ” for a description of certain of the risks you should carefully consider before investing in the New Notes.
Certain U.S. Federal Income Tax Considerations	The Dollar Senior Secured Notes, Euro Senior Secured Notes or New Senior Notes may be treated as having been issued with original issue discount for U.S. federal income tax purposes. An obligation generally is treated as having been issued with original issue discount if its stated principal amount exceeds its issue price by at least a defined de minimis amount. If a New Note is treated as issued with original issue discount, investors subject to U.S. federal income tax will be subject to tax on that original issue discount as ordinary income as it accrues, in advance of the receipt of cash payments attributable to that income (and in addition to qualified stated interest). See “ <i>Tax Considerations—Certain U.S. Federal Income Tax Considerations</i> ”.
Certain ERISA Considerations	The New Notes and any interest therein may, subject to certain restrictions described herein under “ <i>Certain Employee Benefit Plan Considerations</i> ”, be sold and transferred to ERISA Plans (as defined in these Listing Particulars). See “ <i>Certain Employee Benefit Plan Considerations</i> ”.

SUMMARY FINANCIAL INFORMATION AND OTHER DATA

Basis of Presentation

The following tables set forth:

- (a) summary selected Historical Consolidated Financial Information of Altice International derived from the (i) the unaudited condensed consolidated financial statements of Altice International as of and for the three and nine month periods ended September 30, 2014 (including comparative information as of and for the three and nine month periods ended September 30, 2013), prepared in accordance with IAS 34, which have been reviewed by Deloitte Audit S.à r.l. and (ii) the consolidated financial statements of Altice International as of and for the years ended December 31, 2011, 2012 and 2013, prepared in accordance with IFRS, which have been audited by Deloitte Audit S.à r.l.;
- (b) unaudited summary PT Portugal Combined Selected Financial Information as of and for the years ended December 31, 2011, 2012 and 2013 and the nine months ended September 30, 2013 and 2014;
- (c) summary selected historical financial information of ODO derived from the audited stand alone financial statements of ODO as of and for the years ended December 31, 2012 and 2013 and the unaudited stand-alone historical financial statements of ODO as of and for the nine months ended September 30, 2013 (and with respect to information relating to the nine months ended September 30, 2014, derived from the Historical Consolidated Financial Information of Altice International as of and for the nine months ended September 30, 2014);
- (d) summary Illustrative Aggregated Selected Financial Information as of and for the years ended December 31, 2011 and 2012 (which does not aggregate the results of ODO, Tricom or Mobius Group or PT Portugal);
- (e) summary selected Pre-PT/ODO Transactions Pro Forma Financial Information derived from the Pro Forma Financial Information of Altice International (giving effect to each significant acquisition by Altice International but excluding the ODO Acquisition, the PT Portugal Acquisition and the disposal of our mobile network assets in Mayotte and La Réunion which we have committed to undertake and, except as described elsewhere in these Listing Particulars, the Mobius Acquisition and the Tricom Acquisition) as of and for the year ended December 31, 2013;
- (f) summary selected Pre-PT Transaction Pro Forma Financial Information derived from the Pro Forma Financial Information of Altice International (giving effect to each such significant acquisition by Altice International, including the ODO Acquisition) (but not the PT Portugal Acquisition, the disposal of our mobile network assets in Mayotte and La Réunion which we have committed to undertake or, except as described elsewhere in these Listing Particulars, the Mobius Acquisition or the Tricom Acquisition) as of and for the year ended December 31, 2013 and as of and for the nine months ended September 30, 2013 and 2014; and
- (g) summary selected Post Transaction Pro Forma Financial Information derived from the Pro Forma Financial Information of Altice International (giving effect to each such significant acquisition by Altice International, including the ODO Acquisition and the PT Portugal Acquisition) (but not the disposal of our mobile network assets in Mayotte and La Réunion which we have committed to undertake or, except as described elsewhere in these Listing Particulars, the Mobius Acquisition or the Tricom Acquisition) as of and for the year ended December 31, 2013 and as of and for the nine months ended September 30, 2013 and 2014.

For further details regarding the basis of preparation of the Illustrative Aggregated Selected Financial Information, the PT Portugal Combined Selected Financial Information and the Pro Forma Financial Information, please see Note 1 to the Illustrative Aggregated Selected Financial Information, Notes to the PT Portugal Combined Selected Financial Information and Note 2 to the Pro Forma Financial Information included elsewhere in these Listing Particulars. The Illustrative Aggregated Selected Financial Information, the PT Portugal Combined Selected Financial Information and the Pro Forma Financial Information included in these Listing Particulars have not been prepared in accordance with the requirements of Regulation S-X of the U.S. Securities Act, the EU Prospectus Directive, or any generally accepted accounting standards. Neither the assumptions underlying the adjustments nor the resulting aggregated financial information have been audited or reviewed in accordance with any generally accepted auditing standards. The Illustrative Aggregated Selected Financial Information, the PT Portugal Combined Selected Financial Information and the Pro Forma Financial Information are subject to significant limitations. See *“Presentation of Financial and Other Information”* and *“Risk Factors—The Pro Forma Financial Information, the Illustrative Aggregated Selected Financial Information, the Historical Consolidated Financial Information and the PT Portugal Combined Selected Financial Information presented in these Listing Particulars may not reflect what our actual results of operations and financial condition would have been had we been a combined company for the periods presented and thus these results may not be*

indicative of our future operating performance. The Illustrative Aggregated Selected Financial Information, the PT Portugal Combined Selected Financial Information and the Pro Forma Financial Information included herein are subject to certain signification assumptions and limitations”.

The summary financial information presented below should be read together with Altice International’s historical financial statements as of and for the years ended December 31, 2012 and 2013 and the nine months ended September 30, 2013 and 2014, the Illustrative Aggregated Selected Financial Information as of and for the years ended December 31, 2011 and 2012, the PT Portugal Combined Selected Financial Information as of and for the years ended December 31, 2011, 2012 and 2013 and the nine months ended September 30, 2013 and 2014 and the Pro Forma Financial Information as of and for the year ended December 31, 2013 and the nine months ended September 30, 2013 and 2014, including the accompanying notes, included elsewhere in these Listing Particulars.

Altice International (Pre-PT Transaction)

Income Statement Data (Altice International Pre-PT Transaction)

Statement of Income Items	Historical Consolidated Financial Information				
	For the year ended December 31,			For the nine months ended September 30,	
	2011	2012	2013	2013	2014
	€ in millions				
Revenue					
Cable based services.....	560.3	873.3	923.1	694.5	722.0
Mobile services.....	180.6	172.7	256.2	175.9	457.8
B2B and others.....	43.3	46.4	107.4	58.0	193.0
Total revenue.....	784.2	1,092.4	1,286.8	928.4	1,372.8
Purchasing and subcontracting services.....	(175.4)	(302.1)	(367.8)	(262.2)	(324.5)
Gross profit.....	608.8	790.3	919.0	666.2	1,048.3
Other operating expenses ⁽¹⁾	(195.4)	(248.9)	(320.2)	(235.7)	(299.7)
General and administrative expenses.....	(51.2)	(58.1)	(36.2)	(24.0)	(36.8)
Other sales and marketing expenses.....	(64.4)	(80.1)	(43.9)	(29.4)	(84.9)
Operating income before depreciation and amortization⁽²⁾ ...	297.8	403.2	518.8	377.1	626.9
Depreciation and amortization.....	(176.4)	(266.4)	(399.6)	(278.0)	(397.6)
Goodwill impairment.....	—	(121.9)	—	—	—
Other expenses, net ⁽³⁾	(5.6)	(29.8)	15.1	—	—
Management fees.....	(3.1)	(6.2)	(0.6)	(0.7)	(0.6)
Restructuring and other non-recurring costs ⁽³⁾	(7.6)	(20.8)	61.2	(12.3)	(58.5)
Operating profit/(loss).....	105.1	(41.7)	42.3	86.1	170.3
Gain on step acquisitions.....	134.8	—	—	—	—
Share of profit of associates.....	11.7	—	—	—	—
Finance income.....	16.6	30.5	93.6	36.2	32.1
Finance costs.....	(111.6)	(204.7)	(366.9)	(184.3)	(334.3)
Profit/(loss) before taxes on revenue.....	156.6	(215.8)	(201.0)	(62.0)	(132.0)
Income tax benefits/(expenses).....	(32.5)	26.0	(7.4)	(27.4)	(27.6)
Profit/(loss) for the year.....	123.9	(189.8)	(208.4)	(89.4)	(159.6)

(1) “Other operating expenses” also includes staff costs and employee benefits expenses. Beginning with the year ended December 31, 2013, such staff costs and employee benefits have been accounted for in a separate line item and reflect total staff costs for all functions. See the historical financial statements for the nine months ended September 30, 2014 elsewhere in these Listing Particulars for further details. For comparative purposes staff and employee costs have been reclassified for the nine months ended September 30, 2013 to match the new reporting method of the Group.

(2) Further referred to as EBITDA.

(3) With effect from January 1, 2014, “Other expenses, net” have been included in the “Restructuring and other non recurring costs” line item.

Statement of Income Items	Illustrative Aggregated Selected Financial Information ⁽¹⁾		Pre-PT/ODO Transactions Pro-Forma Financial Information ⁽²⁾	Pre-PT Transaction Pro-Forma Financial Information ⁽⁵⁾		
	For the year ended December 31,		For the year ended December 31,	For the year ended December 31,	For the nine months ended September 30,	
	2011	2012	2013	2013	2013	2014
€ in millions						
Revenue						
Cable based services.....	941.2	945.7	953.1	954.7	721.1	728.3
Mobile services.....	306.5	304.4	322.8	769.1	579.8	573.4
B2B and others	178.5	191.6	184.7	183.1	135.3	179.9
Total revenue.....	1,426.2	1,441.8	1,460.6	1,906.9	1,436.1	1,481.6
Purchasing and subcontracting services.....	(399.6)	(444.4)	(433.6)	(555.2)	(429.7)	(351.9)
Gross profit	1,026.6	997.4	1,027.1	1,351.7	1,006.6	1,129.7
Other operating expenses ⁽³⁾	(319.5)	(315.3)	(293.1)	(607.4)	(251.9)	(256.6)
General and administrative expenses ⁽³⁾ ..	(100.9)	(85.1)	(75.3)	—	(91.2)	(75.8)
Other sales and marketing expenses ⁽³⁾ ...	(108.9)	(102.8)	(87.9)	—	(101.9)	(124.9)
Operating income before depreciation and amortization⁽⁴⁾	497.2	494.2	571.2	743.9	561.5	672.3
Depreciation and amortization			(426.7)	(491.0)	(352.2)	(412.9)
Management fees.....			(1.4)	(12.9)	(10.2)	(0.6)
Restructuring and other non-recurring costs			(87.5)	(87.4)	(24.0)	(61.4)
Operating (loss)/profit.....			55.6	153.0	175.1	197.4
Finance income.....			93.8	94.3	36.9	32.8
Finance costs.....			(485.7)	(818.5)	(499.7)	(576.5)
(Loss) before taxes on revenue			(336.3)	(571.2)	(287.7)	(346.2)
Income tax benefits/(expenses).....			(14.5)	(39.9)	(56.8)	(35.8)
Profit for the year/period.....			(350.8)	(611.1)	(344.5)	(382.0)

- (1) The Illustrative Aggregated Selected Financial Information does not aggregate the financial information of Tricom, ODO, Mobius or PT Portugal. For details, see “*Illustrative Aggregated Selected Financial Information of the Group*”. We do not present any Illustrative Aggregated Selected Financial Information below the line item operating income before depreciation and amortization.
- (2) The Pre-PT/ODO Transactions Pro Forma Financial Information does not give pro forma effect to the acquisition of ODO, Tricom, Mobius or PT Portugal for the year ended December 31, 2013. For details, see “*Pro Forma Financial Information of the Group*”. Pro Forma Financial Information does not give pro forma effect to the disposal of our mobile network assets in Mayotte and La Réunion which we have committed to undertake.
- (3) For the Historical Consolidated Financial Information “Other operating expenses” also includes staff costs and employee benefits expenses. Prior to the year ended December 31, 2013, staff costs and employee benefits were recorded under the line items “Other operating expenses”, “General and administrative expenses” and “Other sales and marketing expenses”, depending on the costs which they related to. Beginning with the year ended December 31, 2013, such staff costs and employee benefits have been accounted for in a separate line item and reflect total staff costs for all functions. See the historical financial statements for the year ended December 31, 2013 elsewhere in these Listing Particulars for further details. For comparative purposes staff and employee costs have been reclassified for the year ended December 31, 2012 and for the nine months ended September 30, 2013 to match the new reporting method of the Group. For the Pre-PT/ODO Transactions Pro Forma Financial Information and the Pre-PT Transaction Pro Forma Financial Information, staff costs and employee benefits expenses are accounted for under the line items “Other operating expenses”, “General and administrative expenses” and “Other sales and marketing expenses”, depending on the costs which they related to.
- (4) Further referred to as EBITDA.
- (5) The Pre-PT Transaction Pro Forma Financial Information, among other things, gives pro forma effect to the acquisition of ODO. It does not give pro forma effect to the PT Portugal Acquisition or the acquisition of Tricom or Mobius but includes the contribution of Tricom and Mobius from March 12, 2014, and January 1, 2014, respectively, following their consolidation into the Historical Consolidated Financial Information of Altice International. For details, see “*Pro Forma Financial Information of the Group*”. It does not give pro forma effect to the disposal of our mobile network assets in Mayotte and La Réunion which we have committed to undertake.

Revenue and EBITDA (Altice International Pre-PT Transaction)

The following table sets forth the revenues and EBITDA by geography based on the Illustrative Aggregated Selected Financial Information, the Pre-PT/ODO Transactions Pro Forma Financial Information and the Pre-PT Transaction Pro Forma Financial Information, which do not give pro forma effect to the Tricom Acquisition, Mobius Acquisition or the

PT Portugal Acquisition, but includes the contribution of Tricom and Mobius from March 12, 2014, and January 1, 2014, respectively, following their consolidation into the Historical Consolidated Financial Information of Altice International. The Illustrative Aggregated Selected Financial Information and the Pre-PT/ODO Transactions Pro Forma Financial Information also exclude the ODO Acquisition.

	Illustrative Aggregated Selected Financial Information ⁽¹⁾		Pre-PT/ODO Transactions Pro Forma Financial Information ⁽²⁾	Pre-PT Transaction Pro Forma Financial Information ⁽⁷⁾		
	For the year ended December 31,		For the year ended December 31,	For the year ended December 31		For the nine months ended September 30,
	2011	2012	2013	2013	2013	2014
	€ in millions					
Revenue						
Israel.....	845.5	850.4	881.9	881.9	669.4	645.9
Belgium and Luxembourg.....	67.3	71.3	70.5	70.5	53.2	54.0
Portugal.....	238.8	235.4	209.6	209.6	159.9	140.4
French Overseas Territories.....	217.9	219.6	223.5	223.5	166.3	178.7 ⁽⁹⁾
Dominican Republic ⁽⁸⁾	—	—	—	446.3	333.9	327.4
Others ⁽⁶⁾	56.7	65.2	75.2	75.2	53.4	135.2
Total revenue.....	1,426.2	1,441.8	1,460.7	1,906.9	1,436.1	1,481.6
EBITDA⁽³⁾						
Israel.....	327.2	305.2	363.0	363.0	269.9	314.6
Belgium and Luxembourg.....	41.0	45.6	45.0	45.0	35.4	36.3
Portugal.....	39.0	48.0	58.3	58.3	45.1	44.3
French Overseas Territories.....	72.4	75.1	84.6	84.6	62.1	72.7 ⁽⁹⁾
Dominican Republic ⁽⁸⁾	—	—	—	173.0	131.7	150.0
Others ⁽⁶⁾	17.7	20.3	20.0	20.0	17.7	54.6
Total EBITDA.....	497.2	494.2	570.9	743.9	561.5	672.3
Equity based compensation ⁽⁴⁾	6.0	3.8	—	—	—	—
Adjusted EBITDA⁽⁵⁾.....	503.2	498.0	570.9	743.9	561.5	672.3

(1) The Illustrative Aggregated Selected Financial Information does not aggregate the financial information of Tricom, ODO, Mobius and PT Portugal. For details, see “*Illustrative Aggregated Selected Financial Information of the Group*”. We do not present any Illustrative Aggregated Selected Financial Information below the line item operating income before depreciation and amortization, or EBITDA.

(2) The Pre-PT/ODO Transactions Pro Forma Financial Information does not give pro forma effect to the acquisition of ODO, Tricom, Mobius or PT Portugal for the year ended December 31, 2013. For details, see “*Pro Forma Financial Information of the Group*”. Pro Forma Financial Information does not give pro forma effect to the disposal of our mobile network assets in Mayotte and La Réunion which we have committed to undertake.

(3) EBITDA is defined as operating profit before depreciation and amortization, goodwill impairment, other expenses, net, management fees and restructuring and other non-recurring costs.

(4) Equity-based compensation consists of expenses pertaining to employee stock options provided to employees in Israel.

(5) Adjusted EBITDA is defined as EBITDA before equity based compensation expenses. Adjusted EBITDA is unaudited. We believe that these measures are useful to investors as it provides them with a measure of the operating results which excludes certain items we consider outside of our recurring operating activities or that are non-cash, making trends more easily observable and providing information regarding our operating results and cash flow generation that allows investors to better identify trends in our financial performance. Adjusted EBITDA should not be considered as a substitute measure for operating income and may not be comparable to similarly titled measures used by other companies. “Adjusted EBITDA” of Altice International presented herein corresponds to “EBITDA” as reported by Altice International for financial reporting purposes as of September 30, 2014.

(6) Others includes our B2B telecommunications solutions business and datacentre operations in Switzerland (Green and Green Datacenter), our datacentre operations in France (Auberimmo) and our content production and distribution businesses in France and Luxembourg (Ma Chaîne Sport and SportV). For the nine months ended September 30, 2014, it also includes the contribution made by Tricom from March 12, 2014. We disposed of our interests in Valvision in 2013 (which was included in Others). Green Datacenter and Auberimmo are designated as unrestricted subsidiaries under the terms governing the indebtedness of the Group. Valvision’s contribution to our revenue and EBITDA was not material. In each of the years ended December 31, 2011, 2012 and 2013, Green Datacenter contributed € 4.3 million, €10.3 million and €12.4 million to aggregated and pro forma revenues and €3.6 million, €9.0 million and €10.2 million to aggregated and pro forma EBITDA and Auberimmo’s contribution to our revenue and EBITDA was not material. For the nine months ended September 30, 2013 and 2014, Green Datacenter contributed €8.8 million and €8.2 million to pro forma revenue and €7.6 million and €6.9 million to pro forma EBITDA, respectively.

(7) The Pre-PT Transaction Pro Forma Financial Information, among other things, gives pro forma effect to the acquisition of ODO. It does not give pro forma effect to the PT Portugal Acquisition or the acquisition of Tricom or Mobius but includes the contribution of Tricom and Mobius from March 12, 2014, and January 1, 2014, respectively, following their consolidation into the Historical Consolidated Financial

Information of Altice International. For details, see “*Pro Forma Financial Information of the Group*”. It does not give pro forma effect to the disposal of our mobile network assets in Mayotte and La Réunion which we have committed to undertake.

(8) Excludes Tricom.

(9) Also includes the contribution of Mobius.

ODO

The following table sets forth the revenues and EBITDA based on historical financial statements of ODO, other than the information for the nine months ended September 30, 2014 which has been derived from the Historical Consolidated Financial Information of Altice International.

	For the year ended December 31,			For the nine months ended September 30,		LTM ended September 30 ⁽¹⁾
	2011	2012	2013	2013	2014	2014
	€ in millions					
Revenue						
Dominican Republic (ODO)	417.1	457.4	446.6	333.9	327.4	439.7
EBITDA						
Dominican Republic (ODO)	—	166.7	173.0	131.7	150.0	191.3

(1) LTM ended September 30, 2014 is calculated by (i) adding the revenue, EBITDA for the nine months ended September 30, 2014 and the year ended December 31, 2013 and (ii) subtracting the revenue or EBITDA item for the twelve months ended September 30, 2013 from such sum.

Capital Expenditures (Altice International Pre-PT Transaction)

Pre-PT/ODO Transactions

The following tables set forth cash capital expenditures by geography based on the Illustrative Aggregated Selected Financial Information, the Financial Information and Pre-PT Transaction Pro Forma Financial Information, which do not give effect to the Tricom Acquisition, Mobius Acquisition and ODO Acquisition, but includes the contribution of Tricom and Mobius from March 12, 2014, and January 1, 2014, respectively, following their consolidation into the Financial Information of Altice International. The Illustrative Aggregated Selected Financial Information and the Pre-PT/ODO Transactions Pro Forma Financial Information are presented in the following table.

	Illustrative Aggregated Selected Financial Information ⁽¹⁾											Pre-PT/ODO Transactions		
	For the year ended December 31, 2011						For the year ended December 31, 2012						Israel	Luxembourg
	Israel	Belgium and Luxembourg	Portugal	French Overseas Territories	Others	Total	Israel	Belgium and Luxembourg	Portugal	French Overseas Territories	Others	Total		
	€ in millions													
Capital expenditures														
CPEs and installations	57.3	5.2	12.4	6.4	—	81.3	98.1	4.4	8.7	7.5	—	118.8	49.0	
Cable network and constructions	36.9	2.8	5.4	13.0	—	58.1	55.7	6.4	7.1	7.7	—	76.8	43.0	
Other cable	32.7	2.6	1.6	8.7	—	45.6	57.8	6.2	2.4	0.9	—	67.3	63.3	
Cable based services	126.8	10.6	19.4	28.1	—	185.0	211.6	17.0	18.1	16.1	—	262.8	155.3	
Mobile services	47.1	—	—	17.2	—	64.3	83.8	—	—	9.2	—	93.0	53.6	
B2B and others	—	—	15.0	8.1	21.5	44.6	—	—	12.7	10.5	18.7	41.9	—	
Total capital expenditures	173.9	10.6	34.4	53.5	21.5	293.8	295.4	17.0	30.8	35.7	18.7	397.8	208.9	
EBITDA—total capital expenditures	153.3	30.4	4.6	19.0	(3.8)	203.2	9.8	28.6	17.2	39.4	1.6	96.4	154.1	

- (1) The Illustrative Aggregated Selected Financial Information does not aggregate the financial information of Tricom, ODO, Mobius or PT Portugal. For details, see "Information of the Group".
- (2) The Pre-PT/ODO Transactions Pro Forma Financial Information does not give pro forma effect to the acquisition of ODO, Tricom, Mobius or PT Portugal for the year ended December 31, 2012 and 2013, ODO's total capital expenditures were €73.2 million and €58.5 million, respectively. For the year ended December 31, 2014, ODO's total capital expenditures were approximately \$35 million (approximately €27 million), in each case according to unaudited and unreviewed management accounts.

Pre-PT Transaction

	Pre-PT Transaction Pro Forma Financial Information ⁽¹⁾															
	For the year ended December 31, 2013							For the nine months ended September 30, 2013								
	Israel	Belgium and Luxembourg	Portugal	French Overseas Territories ⁽¹⁾	Dominican Republic ⁽²⁾	Others ⁽¹⁾	Total	Israel	Belgium and Luxembourg	Portugal	French Overseas Territories ⁽¹⁾	Dominican Republic ⁽²⁾	Others ⁽¹⁾	Total	Israel	Belgium and Luxembourg
Capital expenditures																
Cable based services.....	155.3	21.5	18.3	10.6	—	0.3	206	100.0	13.5	14.7	8.4	—	—	136.6	133.0	
Mobile services	53.6	—	—	8.3	58.5	—	120.4	36.0	1.2	—	8.9	38.9	—	85.0	22.8	
B2B and others	—	1.4	5.7	18.5	—	21.8	47.4	—	—	3.6	9.8	—	13.4	26.8	—	
Total capital expenditures.....	208.9	23.0	24.0	36.2	58.5	22.1	372.7	136.0	14.7	18.3	27.1	38.9	13.4	248.4	155.8	
EBITDA—total capital expenditures...	154.1	22	34.3	48.4	114.5	(2.1)	371.2	133.9	20.7	26.8	35.0	93.8	4.0	313.3	158.8	

(1) Excludes Tricom and Mobius but includes the contribution of Tricom (in Others) and Mobius (in French Overseas Territories) from March 12, 2014 and January 1, 2014 in the Historical Consolidated Financial Information of Altice International.

(2) Excludes Tricom.

ODO

The following table sets forth the cash capital expenditures and EBITDA less capital expenditures based on historical financial statements of ODO, other than the information for the nine months ended September 30, 2014, which has been derived from the Historical Consolidated Financial Information of Altice International.

	For the year ended December 31,			For the nine months ended September 30,	
	2011	2012	2013	2013	2014
	€ in millions				
Capital expenditures ⁽¹⁾	70.8	73.2	58.5	38.9	48.4
EBITDA—total capital expenditures	—	93.5	114.5	92.8	101.6

(1) In addition, for the years ended December 31, 2012 and 2013 and the nine months ended September 30, 2013 and 2014, Tricom's total capital expenditures were approximately \$71 million (approximately €56 million) of which approximately \$23 million (approximately €18 million) was spent on 4G/LTE technology upgrades, approximately \$35 million (approximately €27 million), approximately \$28.0 million (approximately €21.0 million) and approximately €13.2 million, respectively. Tricom's capital expenditures have been consolidated in the Historical Consolidated Financial Information of Altice International with effect from March 12, 2014.

Cash Flow Data (Altice International Pre-PT Transaction)

	Historical Consolidated Financial Information				
	For the year ended December 31,			For the nine months ended September 30,	
	2011	2012	2013	2013	2014
	€ in millions				
Cash and cash equivalents at beginning of year/period.....	18.2	19.8	129.7	129.7	61.3
Net cash provided by/(used in) operating activities	306.4	464.5	439.2	288.8	502.7
Net cash provided by/(used in) investing activities	(576.3)	(574.2)	(1,913.6)	(502.2)	(340.8)
Net cash provided by/(used in) financing activities	272.4	219.3	1,405.6	145.4	(83.3)
Effects of exchange rate changes on the balance of cash held in foreign currencies.....	(0.9)	0.2	0.1	—	0.7
Cash and cash equivalents at end of year/period	19.8	129.7	61.3	61.9	140.8

Balance Sheet Data (Altice International Pre-PT Transaction)

	Historical Consolidated Financial Information				
	As of December 31,			As of September 30, 2014	
	2011	2012	2013		
	€ in millions				
Total current assets	150.8	324.5	1,560.6	471.1	
Total non-current assets.....	2,352.9	2,395.5	2,935.4	4,331.6	
Total assets	2,503.7	2,720.0	4,496.0	4,802.7	
Total current liabilities	558.5	546.0	705.2	885.7	
Total non-current liabilities.....	1,211.6	1,888.3	4,052.0	4,010.3	
Total liabilities	1,770.1	2,434.3	4,757.2	4,896.0	
Total equity	733.6	285.7	(261.2)	(93.2)	

PT Portugal

Combined Adjusted Income Statement Data (PT Portugal)

	For the year ended December 31, ⁽¹⁾			For the nine months ended September 30, ⁽¹⁾	
	2011	2012	2013	2013	2014
	€ in millions				
Operating Revenues	2,955.3	2,769.4	2,627.4	1,963.2	1,900.9
Services rendered	2,802.1	2,594.0	2,457.2	1,841.6	1,789.6
Sales	121.7	134.5	126.3	87.8	86.0
Other operating revenues	31.5	41.0	43.8	33.8	25.3
Costs from operations	1,687.6	1,641.8	1,601.0	1,187.5	1,154.4
Wages and salaries	374.0	374.2	361.8	272.1	269.6
Direct costs	472.8	439.7	443.7	328.7	341.5
Commercial costs:					
Costs of products sold	128.6	127.0	124.2	86.0	62.3
Commissions	132.1	126.1	129.1	94.0	55.9
Marketing and publicity	73.1	61.8	59.5	43.4	35.4
Support Services	138.9	139.0	126.7	95.0	98.1
Maintenance and repairs	128.9	101.2	114.1	83.7	66.9
Supplies and external services	203.7	217.5	199.6	144.8	170.9
Provisions	17.6	22.7	22.3	15.2	8.6
Taxes	29.5	31.8	29.3	24.0	29.1
Other operating costs	(11.5)	0.8	(9.4)	0.8	16.0
EBITDA^(*)	1,267.7	1,127.6	1,026.4	775.7	746.6
Post retirement benefits			40.5	31.8	31.4
Depreciation and amortisation			796.7	594.7	577.6
Work force reduction program costs			118.3	119.8	(21.6)
Losses/(gains) on sales disposals of fixed assets, net			(3.6)	(3.1)	(1.1)
Other costs (gains), net			25.1	16.7	14.0
Income before financials and income taxes			49.5	15.8	146.3
Interests, net			269.0	194.8	224.1
Net foreign currency exchange losses/(gains)			4.9	3.0	(2.0)
Losses/(Gains) on financial assets			1.1	1.1	(0.0)
Equity in earnings of associated companies			(4.5)	(3.2)	(2.3)
Net other financial expenses/(income)			11.4	6.9	19.7
Income before income taxes			(232.4)	(186.8)	(93.2)
Provision for income taxes			74.7	34.1	(8.2)
Net income			(307.1)	(220.9)	(85.0)

(1) Reflects the combined income statement data of PT Portugal, including PTC and Meo, S.A. For further information, see "PT Portugal Unaudited Combined Adjusted Financial Information."

* EBITDA comprises income before financial and income taxes plus post retirement costs, depreciation and amortization expenses, work force reduction program costs, net losses/(gains) on sales disposals of fixed assets and net other costs (gains).

Combined Adjusted Balance Sheet Data (PT Portugal)

	As of September 30, 2014 ⁽¹⁾
	€ in millions
ASSETS	
Current Assets	
Cash and equivalents	244.7
Accounts receivable, net	874.3
Inventories, net	75.5
Tax receivable	85.1
Other current assets	48.3
Non current assets held for sale	(0.0)
Total Current Assets	1,327.9

Non-Current Assets	
Investments in associated companies.....	20.7
Investments in intercompany loans.....	3,406.0
Other investments.....	22.9
Goodwill.....	3,723.7
Intangible assets.....	574.5
Fixed assets, net.....	3,103.7
Post retirement benefits.....	1.9
Deferred taxes.....	391.5
Other non-current assets.....	1.8
Total Non-Current Assets.....	11,246.7
Total Assets.....	12,574.5
LIABILITIES	
Current Liabilities	
Short term debt.....	477.6
Short term intercompany debt.....	1,340.2
Accounts payable.....	478.2
Accrued expenses.....	345.1
Deferred income.....	159.0
Tax payable.....	90.9
Provisions.....	49.9
Other liabilities.....	0.4
Total Current Liabilities.....	2,941.3
Non-Current liabilities	
Medium and long-term debt.....	876.8
Medium and long-term Intercompany debt.....	6,859.6
Accounts payable.....	19.0
Deferred income.....	0.0
Provisions.....	1.3
Post retirement benefits.....	1,073.6
Deferred taxes.....	141.5
Other liabilities.....	19.0
Total Non-Current Liabilities.....	8,990.8
Total Liabilities.....	11,932.1
Net Assets.....	642.5

(1) Reflects the combined balance sheet of PT Portugal before adjustments to reflect the effects of certain transactions agreed between Oi and Altice that are expected to be completed prior to the completion of the PT Portugal Acquisition. For more information, including the basis of preparation for the combined balance sheet, see "PT Portugal Unaudited Combined Adjusted Financial Information" and "PT Portugal Pre-Closing Unaudited Combined Pro Forma Balance Sheet".

Combined Adjusted Cash Flow Data (PT Portugal)

	For the year ended December 31,			For the nine months ended September 30,	
	2011	2012	2013	2013	2014
	€ in millions				
OPERATING ACTIVITIES					
Collections from Clients.....	3,647.4	3,468.0	3,049.9	2,323.2	2,167.3
Payments to Suppliers.....	(1,681.2)	(1,697.7)	(1,453.9)	(1,060.2)	(953.1)
Payments to Employees.....	(408.1)	(400.0)	(400.7)	(293.3)	(284.1)
Payments relating to income taxes....	(166.1)	(71.4)	(117.7)	(85.3)	(55.8)
Payments relating to post retirement benefits, net.....	(199.2)	(181.8)	(178.7)	(136.3)	(137.3)
Payments relating to indirect taxes and other.....	(180.4)	(228.5)	(230.0)	(228.3)	(151.7)
Cash Flows from Operating Activities.....	1,012.3	888.6	668.9	519.8	585.2
INVESTING ACTIVITIES					
Cash receipts resulting from					
Short-term financial applications..	—	285.5	38.5	38.3	55.9
Financial investments.....	2,142.8	116.5	2,307.3	2,306.9	6,451.2
Tangible and intangible assets.....	10.3	6.5	7.7	6.4	5.6

Interest and related income	73.4	100.7	119.4	101.9	43.0
Dividends.....	2.6	6.6	5.8	5.9	2.4
Other investing activities.....	323.3	1.9	0.2	0.1	11.3
	2,552.3	517.6	2,478.9	2,459.4	6,569.5
Payments resulting from					
Short-term financial applications..	0	0	(40.8)	(40.7)	(11.4)
Financial investments.....	(3,990.4)	(2,271.6)	(2,508.9)	(2,459.2)	(6,563.2)
Tangible assets.....	(605.2)	(625.5)	(526.7)	(404.8)	(291.0)
Intangible assets.....	(64.9)	(138.1)	(33.3)	(23.3)	(25.4)
Other investing activities.....	(11.3)	(1.6)	(0.6)	(0.6)	(200.0) ⁽¹⁾
	(4,671.8)	(3,036.9)	(3,110.3)	(2,928.5)	(7,091.0)
Cash Flows from Investing Activities	(2,119.5)	(2,519.3)	(631.4)	(469.2)	(521.5)
FINANCING ACTIVITIES					
Cash receipts resulting from					
Loans obtained.....			1,536.3	1,449.1	9,232.8
Increases in share capital and paid-in surplus			2,134.2	34.2	1,250.0
Subsidies.....			1.7	1.3	1.9
Other financing activities			—	—	—
			3,672.2	1,484.6	10,484.8
Payments resulting from					
Loans repaid			(1,392.8)	(1,378.9)	(7,101.3)
Amortization of leasing contracts .			(22.2)	(16.0)	(15.8)
Reductions in share capital and paid-in surplus			(2,135.5)	(35.5)	(2,967.7)
Interest and related expenses.....			(304.5)	(226.2)	(356.9)
Dividends.....			(0.9)	(0.9)	(0.9)
			(3,856.0)	(1,657.5)	(10,442.6)
Cash Flows from Financing Activities			(183.9)	(172.9)	42.2

- (1) The payment related to other investment activities of €200 million for the nine months ended September 30, 2014, relates to the subscription of commercial paper of Rio Forte Investments, S.A. (“Rio Forte”) on April 15, 2014, and matured on July 15, 2014, which was not repaid by Rio Forte on the respective maturity date. This investment is carved-out from the unaudited balance sheet as of September 30, 2014, presented in the section “PT Portugal Unaudited Combined Adjusted Financial Information”, as it is out of the scope of the transaction perimeter.

Revenue and EBITDA (PT Portugal)

	PT Portugal Combined Selected Financial Information					
	For the year ended December 31,			For the nine months ended September 30,		LTM ended September 30 ⁽²⁾
	2011	2012	2013	2013	2014	2014
	€ in millions					
Revenue						
Portugal (PT Portugal).....	2,955.3	2,769.4	2,627.4	1,963.2	1,900.9	2,565.1
Intercompany adjustments.....			(30.6)	(24.3)	(17.6)	(23.9)
EBITDA⁽¹⁾						
Portugal (PT Portugal).....	1,267.7	1,127.6	1,026.4	775.7	746.6	997.2

- (1) For EBITDA reconciliation between Portuguese and International format, see “Management’s Discussion and Analysis of Financial Condition and Results of Operations of the PT Portugal Group—Summary of Significant Differences between Portuguese GAAP and IFRS”.
- (2) LTM for the period ended September 30, 2014 is calculated by (i) adding the revenue, EBITDA or Adjusted EBITDA or other applicable line item for the nine months ended September 30, 2014 and the year ended December 31, 2013 and (ii) subtracting the revenue, EBITDA or Adjusted EBITDA or other applicable line item for the nine months ended September 30, 2013 from such sum.

Capital Expenditures (PT Portugal)

The following table sets forth the gross cash capital expenditures and EBITDA less capital expenditures of the PT Portugal Group based on the PT Portugal Combined Selected Financial Information.

	PT Portugal Combined Selected Financial Information				
	For the year ended December 31,			For the nine months ended September 30,	
	2011	2012	2013	2013	2014
	€ in millions				
Total gross cash capital expenditures ⁽¹⁾	670.1	763.6	560.0	428.1	316.4
EBITDA—total cash capital expenditures	597.6	364.0	466.4	347.6	430.2

(1) The capital expenditures figures included are on a cash basis. For the years ended December 31, 2011, 2012 and 2013 and the nine months ended September 30, 2013 and 2014, the accrued capital expenditures of the PT Portugal Group based on the PT Portugal Combined Selected Financial Information were €798.6 million, €571.7 million, €520.3 million, €356.3 million and €231.0 million, respectively. See “Management’s Discussion and Analysis of Financial Condition and Results of Operations of the PT Portugal Group—Capital Expenditures”.

The following tables set forth the accrued capital expenditures of the PT Portugal Group by entity and by segment based on the PT Portugal Combined Selected Financial Information:

	Year ended December 31,			Nine months ended September 30,	
	2011	2012	2013	2013	2014
		€ in millions			
PTC	515.3	392.8	341.1	229.3	170.7
Meo, S.A.	280.1	140.8	107.5	70.2	42.3
Sub-total	795.4	533.6	448.6	299.5	213.0
Other entities included in the transaction perimeter	3.2	38.1	71.7	56.8	18.0
Total combined accrued capital expenditure	798.6	571.7	520.3	356.3	231.0

	Year ended December 31,		Nine months ended September 30,	
	2012	2013	2013	2014
		€ in millions		
Customer	180.2	158.7	119.7	98.5
B2C	123.4	98.9	73.2	67.7
B2B	55.0	57.6	45.1	29.4
Other	1.8	2.1	1.4	1.4
Infrastructure	266.1	199.3	121.7	75.7
IT/IS	90.5	110.8	88.6	40.7
Other	18.6	21.2	6.6	6.2
Telecommunications business	555.5	490.0	336.7	221.1
Support companies and other entities	16.2	30.3	19.6	9.9
Total combined capital expenditure	571.7	520.3	356.3	231.0

Altice International and PT Portugal

Post-Transaction Pro Forma Financial Information

Income Statement Data (Altice International and PT Portugal)

Statement of Income Items	Post-Transaction Pro Forma Financial Information ⁽¹⁾		
	For the year ended December 31,	For the nine months ended September 30,	
	2013	2013	2014
	€ in millions		
Revenue			
Total revenue	4,503.6	3,375.0	3,365.0
Purchasing and subcontracting services.....	(1,097.7)	(823.8)	(742.9)
Other operating expenses ⁽²⁾	(1,635.2)	(1,214.0)	(1,203.2)
Operating income before depreciation and amortization⁽³⁾	1,770.7	1,337.2	1,418.9
Depreciation and amortization.....	(1,287.7)	(946.9)	(990.4)
Management fees.....	(12.9)	(10.2)	(0.6)
Restructuring and other non-recurring costs and other expenses.....	(267.6)	(189.2)	(84.1)
Operating profit	202.5	190.9	343.7
Finance income.....	94.3	36.9	34.8
Finance costs.....	(1,105.0)	(705.5)	(820.3)
Share of profit of associates.....	4.5	3.2	2.3
Loss before taxes on revenue	(803.6)	(474.5)	(439.5)
Income tax benefits/(expenses).....	(114.6)	(90.9)	(27.6)
Loss for the year/period	(918.2)	(565.4)	(467.0)

(1) The Post-Transaction Pro Forma Financial Information, among other things, gives pro forma effect to the acquisition of ODO and PT Portugal. It does not give pro forma effect to the acquisition of Tricom or Mobius but includes the contribution of Tricom and Mobius from March 12, 2014, and January 1, 2014, respectively, following their consolidation into the Historical Consolidated Financial Information of Altice International. For details, see “Pro Forma Financial Information of the Group”. Post-Transaction Pro Forma Financial Information does not give pro forma effect to the disposal of our mobile network assets in Mayotte and La Réunion which we have committed to undertake.

(2) Also includes “staff costs and employee benefits expenses” which is presented as a separate line item on the Group’s consolidated statement of income.

(3) Further referred to as EBITDA.

Pro Forma Revenue and Adjusted EBITDA (Altice International and PT Portugal)

	Post-Transaction Pro Forma Financial Information ⁽¹⁾			
	For the year ended December 31, 2013	For the nine months ended September 30,		LTM ended September 30, 2014 ⁽²⁾
		2013	2014	
	€ in millions			
Revenue				
Israel.....	881.9	669.4	645.9	858.4
Belgium and Luxembourg.....	70.5	53.1	54.0	71.4
Portugal.....	2,806.3	2,098.8	2,023.7	2,731.3
<i>of which Cabovisão and ONI</i>	209.6	159.8	140.4	190.1
<i>of which PT Portugal</i>	2,627.4	1,963.2	1,900.9	2,565.1
<i>intercompany adjustments</i>	(30.6)	(24.3)	(17.6)	(23.9)
<i>French Overseas Territories⁽³⁾</i>	223.5	166.3	178.7	236.0
<i>Dominican Republic⁽⁴⁾</i>	446.3	333.9	327.4	439.7
<i>Tricom adjustment⁽¹¹⁾</i>				66.9
<i>Others⁽⁵⁾</i>	75.2	53.4	135.2	157.0
Total revenue	4,503.7	3,375.0	3,365.0	4,560.6
EBITDA⁽⁶⁾				
Israel.....	363.0	269.9	314.6	407.8
Belgium and Luxembourg.....	45.0	35.4	36.3	45.9
Portugal.....	1,084.7	820.9	790.9	1,054.6

<i>of which Cabovisão and ONI</i>	58.3	45.1	44.3	57.4
<i>of which PT Portugal</i>	1,026.4	775.7	746.6	997.2
<i>intercompany adjustments</i>	—	—	—	—
French Overseas Territories ⁽³⁾	84.6	62.0	72.7	95.3
Dominican Republic ⁽⁴⁾	173.0	131.7	150.0	191.3
Tricom adjustment ⁽¹¹⁾	—	—	—	23.6
Others ⁽⁵⁾	20.0	17.3	54.6	57.2
Total EBITDA	1,770.3	1,337.2	1,418.9	1,875.7
Equity based compensation ⁽⁷⁾	—	—	—	—
Total Adjusted EBITDA ⁽⁸⁾	1,770.3	1,337.2	1,418.9	1,875.7
Pro Forma Synergies for Previous Transactions ⁽⁹⁾				15.0
Pro Forma Synergies for PT Portugal ⁽¹⁰⁾				100.0
Pro Forma Adjusted EBITDA				1,990.7

- (1) The Post-Transaction Pro Forma Financial Information, among other things, gives pro forma effect to the acquisition of ODO (which is included under “Dominican Republic”) and PT Portugal (which is included under “Portugal”). Save for the LTM column, it does not give pro forma effect to the acquisition of Tricom or Mobius but includes the contribution of Tricom and Mobius from March 12, 2014, and January 1, 2014, respectively, following their consolidation into the Historical Consolidated Financial Information of Altice International. For details, see “Pro Forma Financial Information of the Group”. Post-Transaction Pro Forma Financial Information does not give pro forma effect to the disposal of our mobile network assets in Mayotte and La Réunion which we have committed to undertake.
- (2) LTM ended September 30, 2014 is calculated by (i) adding the revenue, EBITDA or Adjusted EBITDA or other applicable line item for the nine months ended September 30, 2014 and the year ended December 31, 2013 and (ii) subtracting the revenue, EBITDA or Adjusted EBITDA or other applicable line item for the nine months ended September 30, 2013 from such sum.
- (3) For the nine months ended September 30, 2014, “French Overseas Territories” also includes the contribution of Mobius. In connection with the acquisition of SFR by Numericable-SFR S.A. (which is controlled by our parent Altice S.A., and therefore an affiliate of the Group), we have entered into a commitment with the French Competition Authority to dispose of our mobile network assets in Mayotte and La Réunion (which are part of our Group’s business in the French Overseas Territories) by mid-2015.
- (4) Includes ODO but excludes Tricom.
- (5) Others includes our B2B telecommunications solutions business and datacenter operations in Switzerland (Green and Green Datacenter), our datacenter operations in France (Auberimmo) and our content production and distribution businesses in France and Luxembourg (Ma Chaîne Sport and Sportv). For the nine months ended September 30, 2014, it also includes the contribution made by Tricom from March 12, 2014. We disposed of our interests in Valvision in 2013 (which was included in Others). Green Datacenter and Auberimmo are designated as unrestricted subsidiaries under the terms governing the indebtedness of the Group. Valvision’s contribution to our revenue and EBITDA was not material. In each of the years ended December 31, 2011, 2012 and 2013, Green Datacenter contributed €4.3 million, €10.3 million and €12.4 million to aggregated and pro forma revenues and €3.6 million, €9.0 million and €10.2 million to aggregated and pro forma EBITDA and Auberimmo’s contribution to our revenue and EBITDA was not material. For the nine months ended September 30, 2013 and 2014, Green Datacenter contributed €8.8 million and €8.2 million to pro forma revenue and €7.6 million and €6.9 million to pro forma EBITDA, respectively.
- (6) EBITDA is defined as operating profit before depreciation and amortization, goodwill impairment, other expenses, net, management fees and restructuring and other non-recurring costs. We believe that this measure is useful to readers of our financial information as it provides them with a measure of the operating results which excludes certain items we consider outside of our recurring operating activities or that are non-cash, making trends more easily observable and providing information regarding our operating results and cash flow generation that allows investors to better identify trends in its financial performance. EBITDA should not be considered as a substitute measure for operating income and may not be comparable to similarly titled measures used by other companies.
- (7) Equity based compensation consists of expenses pertaining to employee stock options provided to employees in Israel.
- (8) Adjusted EBITDA is defined as EBITDA before equity based compensation expenses.
- (9) Giving effect to certain synergies expected to result from the 2013 June Transactions (including the Outremer Transaction and the ONI Transaction which were consummated in the third quarter of 2013) and to certain synergies expected to result over time from the ODO Acquisition and the Tricom Acquisition. See “General Description of our Business—History”. We may not be able to achieve all such synergies for a number of reasons. These synergy estimates are based on a number of assumptions made in reliance on the information available to us and management’s judgments based on such information. The assumptions used in estimating synergies are inherently uncertain and are subject to a wide variety of significant business, economic, and competitive risks and uncertainties that could cause actual results to differ materially from those contained in the synergy benefit estimates.
- (10) Gives effect to certain synergies expected to result over time from the PT Portugal Acquisition, which is expected to include substantial cost savings in the following areas: subcontractor rationalization, increased buying power through combined procurement, reduction in interconnection costs through re-routing to Altice’s international backbone, reduction in IT spending, simplification of operating practices and outsourcing of customer care.
- (11) For the purposes of the LTM ended September 30, 2014 only, pro forma effect is given to the acquisition of Tricom, including the non-consolidated portion of Tricom prior to Tricom’s consolidation into the Historical Consolidated Financial Information of Altice International from March 12, 2014, which is accounted for under “Tricom adjustment”, and the contribution from Tricom from March 12, 2014, following its consolidation into the Historical Consolidated Financial Information of Altice International.

Balance Sheet Data (Altice International and PT Portugal)

	Post- Transaction Pro Forma Financial Information⁽¹⁾ <hr/> As of September 30, 2014 <hr/> € in millions
Total current assets	1,545.1
Total non-current assets.....	11,213.1
Total assets	12,758.2
Total current liabilities	2,000.1
Total non-current liabilities.....	9,556.7
Total liabilities	11,556.8
Total equity	1,200.2

- (1) The Post-Transaction Pro Forma Financial Information, among other things, gives pro forma effect to the acquisition of ODO and PT Portugal (using the combined balance sheet of PT Portugal after adjustments to reflect the effects of certain transactions agreed between Oi and Altice that are expected to be completed prior to the completion of the PT Portugal Acquisition) and includes the contribution of Tricom and Mobius from March 12, 2014, and January 1, 2014, respectively, following their consolidation into the Historical Consolidated Financial Information of Altice International. For details, see “Pro Forma Financial Information of the Group” “PT Portugal Combined Adjusted Financial Information” and “PT Portugal Pre-Closing Combined Pro Forma Balance Sheet.” *Post-Transaction Pro Forma Financial Information does not give pro forma effect to the disposal of our mobile network assets in Mayotte and La Réunion which we have committed to undertake.*

Certain As Adjusted Information (Altice International and PT Portugal)**

	LTM ended September 30, 2014⁽³⁾
	€ in millions
As adjusted total net debt ⁽¹⁾	7,319
As adjusted senior net debt ⁽²⁾	6,076
LTM Pro Forma Adjusted EBITDA ⁽³⁾	1,991
As adjusted cash interest expense ⁽⁴⁾	489
Ratio of as adjusted total net debt to LTM Pro Forma Adjusted EBITDA	3.7x
Ratio of as adjusted senior net debt to LTM Pro Forma Adjusted EBITDA	3.1x
Ratio of LTM Pro Forma Adjusted EBITDA to as adjusted cash interest expense	4.1x

** Assumes that the PT Portugal Acquisition is consummated. The completion of the PT Portugal Acquisition is subject to certain conditions, including the separate approval by the competent regulatory authorities in Portugal and merger-control clearance from the European Commission. For further details, see “*Capitalization*”.

- (1) As adjusted total net debt reflects the aggregate principal amount of our debt (including financial leases of Altice) minus cash and cash equivalents, in each case on an as adjusted basis after giving effect to the New Transactions and to the repayment of the Existing Coditel Mezzanine Facility with proceeds from our Existing Revolving Credit Facilities which occurred on December 2, 2014.
- (2) As adjusted senior net debt reflects the aggregate principal amount of our debt (including financial leases) that is outstanding under the 2012 Senior Secured Notes, the 2013 December Senior Secured Notes, the 2013 Term Loan, the Existing HOT Unsecured Notes, the amounts drawn under the Existing Revolving Credit Facilities, the amounts expected to be drawn under the New Revolving Credit Facilities to consummate the PT Portugal Acquisition, the New Term Loan and the New Senior Secured Notes minus cash and cash equivalents, in each case, as adjusted after giving effect to the New Transactions and to the repayment of the Existing Coditel Mezzanine Facility with proceeds from our Existing Revolving Credit Facilities which occurred on December 2, 2014.
- (3) LTM ended September 30, 2014 is calculated by (i) adding the revenue, EBITDA or Adjusted EBITDA or other applicable line item for the nine months ended September 30, 2014 and the year ended December 31, 2013 and (ii) subtracting the revenue, EBITDA or Adjusted EBITDA or other applicable line item for the nine months ended September 30, 2013 from such sum. For the purposes of the LTM ended September 30, 2014, only, pro forma effect is given to the acquisition of Tricom, including the non-consolidated portion of Tricom prior to Tricom’s consolidation into the Historical Consolidated Financial Information of Altice International from March 12, 2014 and the contribution of Tricom from March 12, 2014, following its consolidation into the Historical Consolidated Financial Information of Altice International.
- (4) As adjusted cash interest expense represents the gross cash interest expense (excluding any hedging expenses) which is calculated using the cash interest expense in connection with the debt incurred in connection with the New Transactions, the 2013 Term Loan, the Existing HOT Unsecured Notes, the Existing Revolving Credit Facilities, the 2012 Notes, the 2013 June Senior Notes, the 2013 December Senior Secured Notes and the 2013 December Senior Notes. As adjusted cash interest expense has been presented for illustrative purposes only and does not purport to represent what our interest expense would actually have been had the New Transactions occurred nor does it purport to project our interest rate for any future period or financial condition at any future. Interest expense excludes (a) other financing costs relating to (i) foreign exchange transactions, collection costs and embedded derivatives, (ii) bank charges and credit card commissions, and (iii) refinancing and reorganization costs, (b) interest income and (c) the impact of hedging transactions.

Key Operating Measures

Pre-PT Transaction Operating Data

The following key operating data gives effect to the ODO Acquisition, Tricom Acquisition, Mobius Acquisition, but does not give effect to the F

	As of and for the year ended December 31, 2012 in thousands except percentages and as otherwise indicated						As of and for the year ended December 31, 2013 in thousands except percentages and as otherwise indicated						As of and for the year ended December 31, 2014 in thousands except percentages and as otherwise indicated	
	Israel ⁽⁶⁾	Belgium and Luxembourg	Portugal	French Overseas Territories ⁽⁷⁾	Dominican Republic ⁽¹⁰⁾	Total ⁽⁸⁾	Israel ⁽⁶⁾	Belgium and Luxembourg	Portugal	French Overseas Territories ⁽⁷⁾	Dominican Republic ⁽¹⁰⁾	Total ⁽⁸⁾	Israel ⁽⁶⁾	Belgium and Luxembourg
CABLE-BASED SERVICES														
Market and Network														
Homes Passed.....	2,243	233	906	154	372 ⁽¹¹⁾	3,908	2,282	233	908	154	456 ⁽¹¹⁾	4,033	2,329	233
Docsis 3.0 Upgraded (%).....	100%	100%	94%	37%	33%	89.7%	100%	100%	99%	53%	100%	98.0%	100%	100%
Unique Customers														
Cable Customer Relationships ⁽¹⁾	1,198	120	255	39	136	1,748	1,127	114	237	40	103	1,621	1,088	114
Triple-Play Cable Customer Relationships.....	413	50	147	12	—	622	452	50	135	17	45	699	484	50
RGUs & Penetration⁽²⁾⁽³⁾														
Total RGUs.....	2,343	244	648	63	169	3,466	2,295	239	603	74	165	3,376	2,270	239
Pay Television RGUs.....	896	136	245	39	136 ⁽²⁾	1,452	875	129	224	40	108 ⁽²⁾	1,376	862	129
Pay Television Penetration (%).....	40%	58%	27%	25%	37%	37%	38%	55%	25%	26%	24%	34%	37%	55%
Broadband Internet RGUs.....	771	55	159	12	22	1,019	744	57	156	17	30	1,004	727	57
Broadband Internet Penetration (%).....	34%	24%	18%	8%	6%	26%	33%	25%	17%	11%	7%	25%	31%	25%
Fixed-Line Telephony RGUs.....	676	53	243	12	12	996	676	53	223	17	26	995	681	53
Fixed-Line Telephony Penetration (%).....	30%	23%	27%	8%	3%	25%	30%	23%	25%	11%	6%	25%	29%	23%
RGUs Per Cable Customer Relationship.....	2.0x	2.0x	2.5x	1.6x	1.2x	2.0x	2.0x	2.1x	2.54x	1.86x	1.6x	2.1x	2.1x	2.1x
ARPU⁽⁴⁾														
Cable ARPU (€).....	44.4	39.5	34.9	48.3	21.5 ⁽¹⁶⁾	—	47.6	41.9	34.6	51.4	19.7 ⁽¹⁶⁾	—	48.8	41.9
MOBILE-BASED SERVICES														
Market and Network														
UMTS Mobile Coverage of Territory (%).....	41%	—	—	89%	—	—	61%	—	—	89%	—	—	56.3%	—
Subscribers														
Total Mobile Subscribers ⁽⁵⁾	766	2	—	385 ⁽¹⁵⁾	3,372 ⁽¹²⁾	4,525	810	3	—	375 ⁽¹⁵⁾	3,615 ⁽¹²⁾	4,803	932	810
Post-paid.....	738	2	—	183 ⁽¹⁵⁾	608 ⁽¹²⁾⁽¹³⁾	1,531	801	3	—	197 ⁽¹⁵⁾	648 ⁽¹²⁾⁽¹³⁾	1,649	927	801
Prepaid.....	28	—	—	203 ⁽¹⁵⁾	2,764 ⁽¹²⁾⁽¹⁴⁾	2,995	9	—	—	178 ⁽¹⁵⁾	2,968 ⁽¹²⁾⁽¹⁴⁾	3,155	5	9
ARPU⁽⁴⁾														
Mobile ARPU (€).....	19.4	14.7	—	26.7	—	—	16.8	36.8	—	27.1	—	—	15.0	16.8
xDSL/NON-CABLE BASED SERVICES														
RGUs														
Total RGUs.....	—	—	—	140	351	491	—	—	—	133	484	617	—	—
Broadband Internet RGUs.....	—	—	—	57	96	153	—	—	—	56	236	292	—	—
Fixed Line Telephony RGUs.....	—	—	—	83	255	338	—	—	—	78	248	326	—	—

- (1) Cable Customer Relationships represents the number of individual end users who have subscribed for one or more of our cable based services (including pay television) without regard to how many services to which the end user subscribed. It is calculated on a unique premises basis. Cable Customer Relationships does not include subscribers who have not been billed.
- (2) RGUs relate to sources of revenue, which may not always be the same as customer relationships. For example, one person may subscribe for two different services, then be counted as two RGUs. RGUs for pay television and broadband internet are counted on a per service basis and RGUs for fixed-line telephony are counted on a per line basis. For the Dominican Republic, RGUs represent “Equivalent Billing Units” of Tricom.
- (3) Penetration rates for our pay television, broadband internet and fixed-line telephony services are presented as a percentage of homes passed.
- (4) ARPU is an average monthly measure that we use to evaluate how effectively we are realizing revenue from subscribers. ARPU is calculated by dividing the revenue for a period by the average number of customer relationships for that period and further adjusted for non-customer related revenue (such as hosting fees paid by channels) for the respective period by the average number of customer relationships for that period and further adjusted for non-customer related revenue. The average number of customer relationships is calculated as the number of customer relationships on the first day in the respective period plus the number of customer relationships on the last day in the respective period, divided by two.

divided by two. For Israel, cable based ARPU has been calculated by using the following exchange rates: (i) average rate for the year ended December 31, 2011 €0.2009 = NIS 1.00, (ii) average rate for the year ended December 31, 2012 €0.2018 = NIS 1.00, (iii) average rate for the year ended December 31, 2013, €0.2092 = NIS 1.00, (iv) average rate for the nine months ended September 30, 2014, €0.2113 = NIS 1.00. For the Dominican Republic (Tricom), cable-based ARPU includes only revenues related to additional set top boxes and other value added and premium services, and does not include ARPU from broadband internet and fixed-line telephony services.

- (5) Mobile subscribers is equal to the net number of lines or SIM cards that have been activated on our mobile network. For the Dominican Republic (Tricom), mobile subscribers. In Israel, the total number of mobile subscribers for our iDEN and UMTS services were as follows:

	As of December 31	
	2011	2012
Mobile Subscribers		
iDEN	444	32
UMTS.....	—	44
Total.....	444	76

- (6) In Israel, Homes Passed is the number of total Israeli Homes. Our cable network passes a vast majority of Israel's 2.3 million households.
- (7) Only relates to the cable based services (pay television, broadband internet and fixed-line telephony) we provide in Guadeloupe and Martinique. Excludes broadband internet (including IPTV) and fixed-line telephony services we provide in Guadeloupe, Martinique, French Guiana, La Reunion and the acquisition of a controlling interest in Outremer in July 2013.
- (8) Total represents the aggregate of the respective key operating measures across all the regions in which we currently operate even if we do not fully control such business for the entire duration of the periods presented. Israel represents operating measures of HOT (in which we acquired a controlling interest in June 2011) and HOT Mobile; Belgium and Luxembourg represents operating measures of Coditel Belgium and Coditel Luxembourg (in which we acquired a controlling interest from the Numericable Group in June 2011); Portugal represents operating measures of Cabovisão (in which we acquired a controlling interest in July 2013); French Overseas Territories represents operating measures of Le Cable and in respect of mobile services only, Outremer (in which we acquired a controlling interest in July 2013).
- (9) Excludes French Guiana.
- (10) Includes Tricom and ODO.
- (11) Includes two way homes passed by Tricom's HFC network.
- (12) Includes subscribers through resellers (dealers and franchises) as ODO enters into direct contractual arrangements with customers of ODO who are considered as active. Includes exclusively mobile subscribers (does not include mobile broadband internet subscribers). Does not include fixed-line subscribers.
- (13) Includes both post-paid residential subscribers and post-paid business subscribers for ODO.
- (14) Active prepaid residential subscribers only for ODO. Prepaid subscribers are considered as inactive when connected on the house network with no outgoing traffic events or with fewer than four incoming traffic events.

- (15) In connection with the acquisition of SFR by Numericable- SFR S.A. (which is controlled by our parent Altice S.A., and therefore an a into a commitment with the French Competition Authority to dispose of our mobile network assets in Mayotte and La Réunion (which French Overseas Territories) by mid-2015.
- (16) Cable ARPU in the Dominican Republic includes only revenues related to pay television services and also revenues from additional se premium services. This does not include ARPU from broadband internet and fixed line telephony.

PT Portugal Operating Data

	As of December 31,			As of September 30,	
	2011	2012	2013	2013	2014
	in thousands except number of RGUs per individual user and ARPU or unless otherwise indicated				
PTC					
Fixed retail accesses (residential and enterprise):					
PSTN/ISDN ⁽¹⁾	2,648	2,604	2,549	2,564	2,503
Broadband customers	1,105	1,225	1,294	1,280	1,354
Pay-TV customers	1,042	1,223	1,315	1,294	1,387
Total fixed retail accesses	4,795	5,052	5,158	5,137	5,244
Triple or Quadruple Play customers	679	833	952	921	1,065
Unique customers	2,851	2,814	2,745	2,766	2,670
Total fixed retail accesses/unique customer	1.68	1.80	1.88	1.86	1.96
Non-voice revenues as % of revenues	46.2	51.2	53.2	53.0	55.2
Net additions:⁽²⁾					
PSTN/ISDN	(48)	(43)	(55)	(40)	(46)
Broadband customers	104	119	69	55	60
Pay-TV customers	212	181	91	70	73
Total fixed retail accesses net additions.....	268	257	105	85	87
Residential⁽³⁾					
Fixed retail accesses (residential only)					
PSTN/ISDN	1,674	1,692	1,646	1,652	1,631
Broadband customers	911	1,015	1,027	1,019	1,075
Pay-TV customers	972	1,135	1,157	1,146	1,209
Total fixed retail accesses	3,557	3,841	3,830	3,817	3,915
Triple or Quadruple Play customers	623	769	824	803	912
Unique customers	1,881	1,881	1,818	1,830	1,779
Total fixed retail accesses/unique customer	1.89	2.04	2.11	2.09	2.20
ARPU (€/month)	30.8	31.6	31.6	31.7	31.9
Non-voice revenues as % of revenues	58.5	63.4	65.7	65.4	68.2
Net additions⁽²⁾					
PSTN/ISDN	1	18	(22)	(16)	(15)
Broadband customers	102	104	(29)	22	48
Pay-TV customers	198	162	43	31	52
Total fixed retail accesses net additions.....	300	284	50	36	85
Enterprise⁽⁷⁾					
Fixed retail accesses (enterprise only)					
PSTN/ISDN	826	725	720	727	695
Broadband customers	193	207	264	258	276
Pay-TV customers	68	86	155	146	176
Total fixed retail accesses net additions.....	(30)	(68)	60	51	8
Unique customers	846	745	724	730	724
Total fixed retail accesses/unique customer	1.28	1.37	1.57	1.55	1.58
Non-voice revenues as % of revenues	46.4	50.3	55.0	53.9	8.4
Meo, S.A.					
Total mobile customers (personal and enterprise)					
Post-paid	7,444	7,598	7,896	7,807	7,881
Prepaid	2,378	2,469	2,925	2,782	3,554
Data as percentage of mobile services revenues.....	5,066	5,129	4,971	5,025	4,327
Net additions: ⁽²⁾	27.7	32.6	36.5	36.2	39.2
Total mobile customers	24	154	298	209	(15)
Post-paid	87	91	456	313	629
Prepaid	(63)	63	(158)	(104)	(644)
Personal⁽⁴⁾					
Total mobile customers (personal only)					
Post-paid	5,932	6,024	6,390	6,320	6,336
Prepaid	1,064	1,093	1,570	1,457	2,132
Minutes of Usage (MOU) (m) ⁽⁵⁾	4,868	4,931	4,820	4,863	4,205
	89	93	98	96	106

ARPU (€/month)	9.7	8.7	7.6	7.7	7.3
Customer.....	8.7	8.0	7.1	7.2	6.7
Interconnection	1.0	0.7	0.5	0.5	0.6
SARC ⁽⁶⁾ (€).....	27.8	27.9	24.6	24.7	23.4
Data as % of mobile service revenues	30.9	33.2	35.8	35.6	38.2
Net Additions⁽²⁾					
Total mobile customers (personal only)	(31)	92	312	243	(53)
Post-paid.....	42	30	441	328	562
Prepaid.....	(73)	62	(129)	(85)	(615)
Enterprise⁽⁷⁾					
Total mobile customers (enterprise only)	1,445	1,514	1,457	1,433	1,503
Net additions⁽²⁾					
Total mobile customers	55.6	68.7	(3.8)	(28.2)	45.7

(1) The public switched telephone network, or PSTN, is the traditional telephone system that runs through copper lines. The integrated digital services network, or ISDN, is the digital telecommunications network that allows simultaneous voice and data transmission over an access line.

(2) The net additions figures for the nine months ended September 30, 2013 and 2014 are calculated on a nine-month basis from December 31, 2012 and 2013, respectively.

(3) The PT Portugal Group's residential customer category provides fixed line telephone and broadband services, pay-TV services (IPTV over ADSL and fiber and DTH satellite TV) services and internet access services to residential customers. PTC is the primary operating company through which the PT Portugal Group provides such residential services.

(4) The PT Portugal Group's personal customer category provides telecommunications and mobile data services for a variety of personal devices, including traditional cell phones, smartphones, tablets and laptops through our mobile business. Meo, S.A. is the primary operating company through which the PT Portugal Group provides its mobile services.

(5) Minutes of Usage represents the monthly average of outgoing traffic in minutes divided by the average number of users in the period.

(6) Subscriber Acquisition and Retention Cost, or SARC, equals the sum of 70% of marketing and publicity costs *plus* commissions *plus* subsidies, divided by gross additions *plus* upgrades.

(7) The PT Portugal Group's enterprise customer category provides enterprise services (including integrated voice, data and image solutions, virtual private networks, convergence solutions, consultancy and outsourcing) to corporate, SMEs and SoHo customers that need diversified telecommunications solutions and integration with IT services through service packages. PTC and, to a lesser extent, Meo, S.A., are the primary operating companies through which the PT Portugal Group provides its enterprise services.

RISK FACTORS

An investment in the New Notes involves risks. Before purchasing the New Notes, you should consider carefully the specific risk factors set forth below, as well as the other information contained in these Listing Particulars. If any of the events described below, individually or in combination, were to occur, this could have a material adverse impact on our business, prospects, results of operations and financial condition and our ability to make payments on the New Notes and could therefore have a negative effect on the trading price of the New Notes. Described below and elsewhere in these Listing Particulars are the risks considered to be the most material, although there may be other unknown or unpredictable economic, business, competitive, regulatory or other factors that also could have material adverse effects on our results of operations, financial condition, business or operations in the future. In addition, our past financial performance may not be a reliable indicator of future performance and historical trends should not be used to anticipate results or trends in future periods. These Listing Particulars also contains forward-looking statements that involve risks and uncertainties. Actual results may differ materially from those anticipated in these forward-looking statements as a result of various factors, including the risks described below and elsewhere in these Listing Particulars. See “Forward-Looking Statements”.

In this section, unless the context otherwise requires, the terms “Group”, “we”, “us” and “our” refers to the Issuers and their subsidiaries (including PT Portugal and its subsidiaries).

Risks Relating to Our Financial Profile and the Transactions

Our substantial leverage could adversely affect our business, financial condition and results of operations and prevent us from fulfilling our obligations under the New Notes or ability to raise additional capital to fund our operations.

We have significant outstanding debt and debt service requirements and may incur additional debt in the future. As of September 30, 2014, the Altice International Group had total third party debt (excluding other long term and short term liabilities, other than finance leases) of €3,730 million on a consolidated basis. As adjusted to reflect all changes to our financial profile since September 30, 2014 including as adjusted to give effect to the New Transactions (including this Offering) and to the repayment of the Existing Coditel Mezzanine Facility with proceeds from our Existing Revolving Credit Facilities which occurred on December 2, 2014, the Altice International Group had total third party debt (excluding other long term and short term liabilities, other than finance leases) of €7,460 million on a consolidated basis. In addition the Senior Secured Issuer will be able to draw up to \$80 million under the 2012 Revolving Credit Facility and € 80 million under the 2013 Revolving Credit Facility (all of which has been drawn as of the date hereof), up to €330 million under the New Super Senior Revolving Credit Facility (of which it is expected that € 180 million will be drawn to complete the PT Portugal Acquisition), up to €501 million under the New Pari Passu Revolving Credit Facility and up to €15 million under the 2013 Guarantee Facility. For a description of such changes to our financial profile and our third party indebtedness, see “Description of Other Indebtedness”.

Although the Altice International Group and the Altice France Group are both controlled by Altice S.A., the Altice International Group is currently financed, and will be financed following the consummation of the New Transactions, on a standalone basis and constitute a separate financing group from the Altice France Group. Each of these financing groups are subject to covenants that restrict the use of their respective cash flows outside their respective restricted group (including between the Altice International Group and the Altice France Group and between Altice S.A. and either of the two groups). Consequently, cash flows from operations of the Altice International Group may not be able to be applied to meet the obligations of the Altice France Group or the obligations of Altice S.A. and other members of the Altice Group and cash flows from operations of the Altice France Group may not be able to be applied to meet the obligations of the Altice International Group, Altice S.A. and other members of the Altice Group.

Our significant level of debt could have important consequences, including, but not limited to, the following:

- making it more difficult for us to satisfy our obligations under the New Notes;
- requiring that a substantial portion of our cash flows from operations be dedicated to servicing debt, thereby reducing the funds available to us to finance our operations, capital expenditures, research and development and other business activities, including maintaining the quality of and upgrading our network;
- impeding our ability to obtain additional debt or equity financing, including financing for capital expenditures, and increasing the cost of any such funding, particularly due to the financial and other restrictive covenants contained in the agreements governing our debt;
- impeding our ability to compete with other providers of pay television, broadband Internet services, fixed-line telephony services, mobile services and B2B services in the regions in which we operate;

- restricting us from exploiting business opportunities or making acquisitions or investments;
- increasing our vulnerability to, and reducing our flexibility to respond to, adverse general economic or industry conditions;
- limiting our flexibility in planning for, or reacting to, changes in our business and the competitive and economic environment in which we operate; and
- adversely affecting public perception of us and our brands.

Any of these or other consequences or events could have a material adverse effect on our ability to satisfy our debt obligations under the New Notes.

The terms of the agreements and instruments governing our debt restrict, but do not prohibit, us from incurring additional debt. We may refinance our debt, and we may increase our consolidated debt for various business reasons which might include, among other things, financing acquisitions, funding the prepayment premiums, if any, on debt we refinance, funding distributions to our shareholders or general corporate purposes. If new debt is added to our consolidated debt described above, the related risks that we now face will intensify.

We may not generate sufficient cash flow to fund our capital expenditures, ongoing operations and debt obligations, and may be subject to certain tax liabilities.

Our ability to service our debt and to fund our ongoing operations will depend on our ability to generate cash. We cannot assure you that our businesses will generate sufficient cash flow from operations or that future debt or equity financing will be available to us in an amount sufficient to enable us to pay our debt obligations when due. Our ability to generate cash flow and to fund our capital expenditures, ongoing operations and debt obligations are dependent on many factors, including:

- our future operating performance;
- the demand and price levels for our current and planned products and services;
- our ability to maintain the required level of technical capability in our networks and in the subscriber equipment and other relevant equipment connected to our networks;
- our ability to successfully introduce new products and services;
- our ability to reduce churn;
- general economic conditions and other conditions affecting customer spending;
- competition;
- sufficient distributable reserves, as required under applicable law;
- the outcome of certain litigation in which we are involved; and
- legal, tax and regulatory developments affecting our business.

Some of these factors are beyond our control. If we are unable to generate sufficient cash flow, we may not be able to repay our debt, grow our business, respond to competitive challenges or fund our other liquidity and capital needs, including capital expenditures. If we are unable to meet our debt service obligations, we may have to sell assets, attempt to restructure or refinance our existing indebtedness or seek additional funding in the form of debt or equity capital. We may not be able to do so on satisfactory terms, if at all.

We expect that a significant amount of our cash flow will consist of payments of dividends or interest by Israeli companies in our Group. In general, payments of dividends or interest by companies that are Israeli residents for tax purposes are subject to withholding tax. With respect to payments to Luxembourg tax residents or residents of other countries who have a tax treaty with Israel, such withholding tax may be reduced from the rates generally applicable under Israeli law to the rates applicable under the tax treaty between Israel and Luxembourg or the other applicable treaty. In order to enjoy the reduced rate of withholding tax, it is necessary to file with the Israel Tax Authority a request for relief from withholding prior to payment of the dividend and/or interest. If a withholding tax exemption or relief

certificate is received from the Israel Tax Authority prior to the payment of the dividend and/or interest, the payer will be able to make the dividend/interest payment at such reduced withholding tax rate. However, if such request is denied or delayed and such certificate is not available at the time of payment, withholding will be made at the full statutory rates. Any changes in the tax rates on dividends or interest could significantly affect our ability to meet our debt service obligations under the New Notes. In addition, payments of dividends or interests by companies resident in the Dominican Republic are subject to a withholding tax of 10%.

The agreements and instruments governing our debt contain restrictions and limitations that could adversely affect our ability to operate our business.

The terms of the agreements and instruments governing our debt contain a number of significant covenants or other provisions that could adversely affect our ability to operate our business. These covenants restrict our ability, and the ability of our subsidiaries, to, among other things:

- pay dividends or make other distributions;
- make certain investments or acquisitions, including participating in joint ventures;
- make capital expenditures;
- engage in transactions with affiliates and other related parties;
- dispose of assets other than in the ordinary course of business;
- merge with other companies;
- incur additional debt and grant guarantees;
- repurchase or redeem equity interests and subordinated debt or issue shares of subsidiaries;
- grant liens and pledge assets; and
- change our business plan.

All of these limitations will be subject to certain exceptions and qualifications, including the ability to pay dividends, make investments or to make significant prepayments of shareholder debt. However, these covenants could limit our ability to finance our future operations and capital needs and our ability to pursue business opportunities and activities that may be in our interest. In addition, our ability to comply with these restrictions may be affected by events beyond our control. In addition, we are also subject to the affirmative covenants contained in certain of the debt agreements we are party to, including the Existing Revolving Credit Facility Agreements, the 2013 Guarantee Facility and the Existing HOT Unsecured Notes which require us to maintain specified financial ratios. Upon entry into the New Revolving Credit Facilities, we will also be required to maintain certain specified financial ratios under these agreements. Our ability to meet these financial ratios may be affected by events beyond our control and, as a result, we cannot assure you that we will be able to meet these ratios.

In addition to limiting our flexibility in operating our business, the breach of any covenants or obligations under the agreements and instruments governing our debt will result in a default under the applicable debt agreement or instrument and could trigger acceleration of the related debt, which in turn could trigger defaults under other agreements governing our debt. A default under any of the agreements governing our other debt could materially adversely affect our growth, financial condition and results of operations.

Moreover, until such time when all of the Existing HOT Unsecured Notes shall be delisted from trading or be repaid in full, HOT will remain a “reporting company” under Israeli law. Reporting companies under Israeli law are subject to extensive disclosure requirements and burdensome corporate governance rules under the Israeli Companies Law, 1999, the Israeli Securities Law, 1968 and the regulations promulgated thereunder, including the provision which requires a reporting company to maintain an independent audit committee, and the approval of the audit committee as a prior condition to any transaction of the reporting company in which the controlling shareholder has a personal interest.

A substantial amount of our indebtedness will mature before the New Notes, and we may not be able to repay this indebtedness or refinance this indebtedness at maturity on favorable terms, or at all.

Of the €7,460 million of total borrowings we would have had outstanding as of September 30, 2014 (including finance leases but excluding other liabilities), as adjusted to give effect to all changes to our capital structure since September 30, 2014, including the New Transactions (including this Offering), €4,172 million (equivalent) of our borrowings, will mature prior to the maturity dates of the New Notes. In addition, €841 million of borrowings we expect to make under the New Term Loan will mature prior to the New Notes.

Our ability to refinance our indebtedness, on favorable terms, or at all, will depend in part on our financial condition at the time of any contemplated refinancing. Any refinancing of our indebtedness could be at higher interest rates than our current debt and we may be required to comply with more onerous financial and other covenants, which could further restrict our business operations and may have a material adverse effect on our business, financial condition, results of operations and prospects and the value of the New Notes. We cannot assure you that we will be able to refinance our indebtedness as it comes due on commercially acceptable terms or at all and, in connection with the refinancing of our debt or otherwise, we may seek additional refinancing, dispose of certain assets, reduce or delay capital investments, or seek to raise additional capital.

We are exposed to interest rate risks. Shifts in such rates may adversely affect our debt service obligations.

As adjusted to give effect to all changes to our capital structure since September 30, 2014, including the New Transactions (including this Offering), as of September 30, 2014, we would have had €2,015 million of floating rate debt. In addition, any amounts we borrow under the Revolving Credit Facility Agreements, the New Revolving Credit Facilities, the New Term Loan or the 2013 Guarantee Facility bear or will bear interest at a floating rate. Further, as of September 30, 2014 we had an amount equivalent to € 148.0 million outstanding under Series A of the HOT Unsecured Notes which is linked to the consumer price index in Israel. An increase in the interest rates on our debt will reduce the funds available to repay our debt and to finance our operations, capital expenditures and future business opportunities. Although we enter into various derivative transactions to manage exposure to movements in interest rates, there can be no assurance that we will be able to continue to do so at a reasonable cost.

Currency fluctuations and interest rate and other hedging risks could adversely affect our earnings and cash flow.

Our business is exposed to fluctuations in currency exchange rates. HOT's primary transactional currency is the New Israel Shekel. The primary transactional currency of Cabovisão, ONI, PT Portugal, Coditel, Outremer Telecom and Le Cable is the Euro. The primary transactional currency of Green is Swiss Francs. The primary transactional currency of Tricom S.A. and ODO is the Dominican Peso. We conduct, and will continue to conduct, transactions in currencies other than such primary transactional currencies, particularly the U.S. dollar. Our existing debt is primarily denominated in U.S. dollars, euros and New Israeli Shekels although the amounts incurred in euros and New Israeli Shekels do not necessarily match the cash flows generated from operations in such currencies. The exchange rate between the U.S. dollar and the New Israeli Shekel, euro, Swiss Franc and the Dominican Peso has fluctuated significantly in recent years and may continue to fluctuate significantly in the future. Further in the past, the Dominican Republic government has imposed exchange controls and currency restrictions and they may do so in the future. This is beyond our control and may result in the Dominican Peso ceasing to be freely convertible or transferable abroad to service our then outstanding indebtedness or otherwise, or the Dominican Peso being significantly depreciated relative to other currencies, including the U.S. dollar. We have historically covered a portion of our U.S. dollar and euro cash outflows arising on anticipated and committed obligations through the use of foreign exchange derivative instruments. Further, while we manage the risk of certain currency fluctuations in respect of a portion of our existing debt and to hedge our exposure to interest rate changes in respect of indebtedness linked to interest rates, these arrangements may be costly and may not insulate us completely from such exposure. There can be no guarantee that our hedging strategies will adequately protect our operating results from the effects of exchange rate fluctuation or changes in interest rates, or that these hedges will not limit any benefit that we might otherwise receive from favorable movements in exchange rates or interest rates.

Negative changes in our credit rating and future ratings downgrades of sovereign debt (such as of Portugal) may have a material adverse effect on our financial condition.

A downgrade in our credit rating (including due to the effects of the economic conditions described below) may negatively affect our ability to obtain future financing (including from financial institutions, retail investors and banks) to fund our operations and capital needs. Any downgrade of our ratings could have even more significant effects on our ability to obtain financing and therefore on our liquidity. It may increase our financing costs by increasing the interest rates of our outstanding debt or the interest rates at which we are able to refinance existing debt or incur new debt.

Our credit rating may be impacted by a number of factors, including the effects of the economic conditions in the countries in which we operate and any future rating downgrades of sovereign debt of these countries. For example,

against the backdrop of the Eurozone crisis, the increased risk perception also led to consecutive downgrades of Portuguese sovereign debt by the rating agencies. In 2011, Portugal was downgraded (1) by 4 notches at Moody's Investors Service, or Moody's, from A1 on December 21, 2010 to Ba2 on July 5, 2011; (2) by 3 notches at Standard & Poor's Ratings Services, or S&P, from A- on November 30, 2011 to BBB- on December 5, 2011; and (3) by 6 notches at Fitch Ratings, or Fitch, from A+ on December 23, 2010 to BB+ on November 24, 2011. In 2012, Portugal was downgraded (1) by 1 notch at Moody's from Ba2 to Ba3 on February 13, 2012; and (2) by 2 notches at S&P from BBB to BB on January 13, 2012.

Because the financial condition, revenues and profitability of PT Portugal, which contributed 16.2% of pro forma revenues and 18.0% of pro forma adjusted EBITDA on a last twelve month basis after giving pro forma effect to the PT Portugal Acquisition, are closely linked to the Portuguese economy, we expect that the ratings under Moody's and S&P's ratings methodologies of the Altice International Group will also be impacted by the Portuguese sovereign debt rating. Any deterioration in the economic condition of Portugal or the other countries in which we operate or any ratings downgrade of sovereign debt of these countries may have a material adverse impact on our financial conditions.

Risks Relating to Our Business, Technology and Competition

We face significant competition in each of the industries in which we operate and competitive pressures could have a material adverse effect on our business.

We face significant competition from established and new competitors in each of the countries and segments in which we operate. The nature and level of the competition we face vary for each of the products and services we offer. Our competitors include, but are not limited to, providers of television, broadband Internet, fixed-line telephony and B2B services using DSL or fiber connections, providers of television services using technologies such as IPTV, providers of television by satellite, DTT providers, mobile network operators, and providers of emerging digital entertainment technologies and other providers of wholesale carrier, infrastructure and white label services.

In some instances, we compete against companies which may have easier access to financing, more comprehensive product ranges, lower financial leverage, greater financial, technical, marketing and personnel resources, larger subscriber bases, wider geographical coverage for their cable or mobile networks, greater brand name recognition and experience or longer established relationships with regulatory authorities, suppliers and customers. Some of our competitors may have fewer regulatory burdens with which they are required to comply because, among other reasons, they use different technologies to provide their services, do not own their own fixed-line network, or are not subject to obligations applicable to operators with significant market power.

Because the telecommunications and mobile markets in certain of the geographic markets in which we operate, including Israel, are reaching saturation, there are a limited number of new subscribers entering the market and therefore in order to increase our subscriber base and market share we are dependent on attracting our competitors' existing subscribers, which intensifies the competitive pressures we are subject to. The competitive landscape in the countries in which we operate is generally characterized by increasing competition, tiered offerings that include lower-priced entry level products and a focus on multiple-play offerings including special promotions and discounts for customers who subscribe for multiple-play services, which may contribute to increased average revenue per unique customer relationship, but will likely reduce our ARPU on a per-service basis for each service included in a multiple-play package. We expect additional competitive pressure to result from the convergence of broadcasting and communication technologies, as a result of which participants in the media and telecommunications industries seek to offer packages of fixed and mobile voice, Internet and video broadcast services. In addition, we expect competition to increase as a result of changes in the regulatory regime seeking to increase competition in the markets in which we operate, such as allowing third party access to cable networks on a wholesale basis.

Our products and services are also subject to increasing competition from alternative new technologies or improvements in existing technologies. For example, our pay television services in certain jurisdictions compete with providers who provide IPTV services to customers in our network areas utilizing DSL or very high bitrate DSL ("VDSL") broadband Internet connections. In the broadband Internet market, we generally face competition from mobile operators as they are increasingly able to utilize a combination of progressively powerful handsets and high bandwidth technologies, such as UMTS and long-term-evolution ("LTE") technology. Mobile services, including those offering advanced higher speed, higher bandwidth technologies and mobile virtual network operators ("MVNOs"), also contribute to the competitive pressures that we face as a fixed-line telephony operator. In the past, mobile operators have engaged in "cut the line" campaigns and used attractive mobile calling tariffs to encourage customers with both fixed-line and mobile services to retain only their mobile services. This substitution, in addition to the increasing use of alternative communications technologies, tends to negatively affect our fixed-line call usage volumes and subscriber growth. At the same time, incumbent fixed-line operators have also applied resources to "win-back" activities that can entice our existing telephony customers, as well as prospective telephony customers, to return or remain with the incumbent by offering certain economic incentives.

In addition, new players from sectors that are either unregulated or subject to different regulations (including Internet players such as Yahoo, Google, Microsoft, Amazon, Skype, Apple, YouTube, Netflix and other audiovisual players, media players and over-the-top (of an existing broadband internet network) players) have emerged as competitors to our content offering. These players are taking advantage of improved connectivity and platform-agnostic technologies to offer over-the-top and cloud-based services. Telecommunications operators are expected to maintain traditional access services and billing relationships over which users access services from adjacent players such as companies offering music, video, photos, apps and retail. The rapid success of audiovisual content streamed through the telecommunications network and insufficient innovation could lead to the emergence of other content or service providers as well as the saturation of the network, which would put pressure on the revenues and margins of operators like our Group while simultaneously requiring them to increase capital expenditures to remain competitive, which could adversely affect our business, financial condition or results of operations.

The following is an overview of the competitive landscape in Israel, Portugal and the Dominican Republic:

Israel

Pay Television. In the multi-channel television market our main competitor is D.B.S. Satellite Services (1998) Ltd, an associate of Bezeq, which provides satellite technology based multi-channel television services under the brand “YES”. Other factors that have a material impact on competition in the market include the availability of free-to-air DTT channels and the increasing availability of video content that may be offered via the Internet. In addition, we believe that the implementation of certain regulatory changes may have an impact on competition in the market, including the expansion in the number of free-to-air DTT channels, the “narrow” television package and the increased scope of special broadcasting licenses pursuant to which we are required to broadcast television channels owned by special broadcasting license holders on our network under certain terms. See “*Regulatory—Israel—Television Access to DTT Channels—Narrow Package Proposal*”.

Broadband Internet Infrastructure Access. Our high-speed broadband Internet infrastructure access service competes primarily with Bezeq, which provides high-speed broadband Internet access over DSL, holds the highest market share in broadband Internet infrastructure access in Israel, and offers a range of products with different download speeds, data transfer limits and other value added services. Continued upgrades to the quality of Bezeq’s DSL-based broadband Internet infrastructure access service to very high bitrate DSL (“VDSL”) and potentially even faster DSL variants and the possibility of widespread fiber-to-the-home installations which it has announced could have a negative impact on our competitive position in the broadband Internet infrastructure market and may also require us to revise our marketing strategy and make potentially significant capital expenditures. Further, the Israeli Ministry of Communications has issued regulatory instructions, including the method of setting wholesale service rates and, in the case of Bezeq, the maximum rates that can be collected by Bezeq from other license holders who make use of its infrastructure for the years 2014 to 2018, in an attempt to create a wholesale market for broadband internet infrastructure access and fixed line telephony services which would allow service providers (such as ISPs, VOB providers and IPTV providers) to provide services to their customers by using our cable network. In addition, the Israeli Ministry of Communications has issued an order requiring HOT to fulfill the universal service obligation. We are currently evaluating the impact of the Israeli Ministry of Communication’s decisions on our business in Israel and while we have not yet made a full assessment of such impact, it is possible that this may result in increased competition. See “*Regulatory—Israel—Obligation to Extend Services*”, and “*Regulatory—Israel—Broadband Internet Infrastructure Access and Fixed Line Telephony—Decision Regarding the Creation of a Wholesale Market*”. Competition may also increase following the creation of a public private joint venture in June 2013 between the government owned Israeli Electric Corporation (“IEC”) and a private company, which proposes to use the electric transmission and distribution network in Israel owned by IEC to provide wholesale products to telecommunication services providers via optical fiber, and thus compete with HOT and Bezeq in the wholesale market as well as providing such services directly to large business customers.

Fixed-Line Telephony. Competition in providing fixed-line telephony service is intense, with providers having introduced substantial price reductions over the past few years. Bezeq, our principal competitor in the Israeli market and the largest provider of fixed-line telephony services, has an extensive fixed-line telephone network throughout Israel, strong market knowledge, high brand recognition and substantial capital resources. We believe that competition in this market will increase due to the low barriers to entry primarily as a result of regulations pursuant to which new service providers, who receive a license, can provide telephony services using voice over Internet protocol (“VoIP”) or voice over broadband Internet (“VOB”) technology over the infrastructure network owned by either us or Bezeq (the end user will still need to purchase access to the infrastructure network directly from us or from Bezeq, until a wholesale market is established). As a result of the wholesale market implementation, the VOB service provider may be entitled to procure the access to the network infrastructure by itself. The Israeli Ministry of Communications requires the various telephony service providers to provide interconnection access in return for payment of an “interconnection fee” set by it. Competition may also increase following the commencement of operations by the proposed IEC joint venture, if successful, and as the result of the policy to develop a wholesale market in telecommunications services. Although our

market share in this segment is increasing, we may not have the resources of, or benefit from the economies of scale available to, Bezeq and other competitors.

Mobile Services. The mobile market in Israel is characterized by saturation and a very high penetration level in excess of 100%, as a result of which competition is focused primarily on customers moving from one mobile operator to another. Our mobile service competes with three principal mobile network operators in Israel, who between them are currently estimated to directly represent over 86% of the total market for mobile services in Israel as of December 31, 2013, by number of mobile customers, and with an additional new mobile network operator (as well as several MVNOs). As such, the brand names of the three principal mobile network operators in Israel are better recognized as mobile service providers than our brand, they have better established sales, marketing and distribution capabilities, and are more experienced in the provision of mobile services. While we acquired HOT Mobile in November 2011, which had an existing iDEN-based mobile network and service offering, we only began offering our 3G based mobile services under the HOT brand in May 2012 and expect that we will continue to face the challenge that the brand names of our competitors are better recognized as mobile service providers and that these competing providers are part of larger, more established companies than us. We may be required to invest significantly in marketing, other promotional activities and our infrastructure to overcome this challenge. We may also face increased competition in the future from Golan Telecom, which launched its services at the same time as HOT Mobile, and MVNOs that provide mobile services under their own brand using the network infrastructure of another service provider. In addition, on November 21, 2012, the Israeli Ministry of Communications issued a policy that permitted VoIP service providers to provide VoC (VoIP over Mobile) services. A licensed VoC service improves user experience, since it has a standard phone number and can be ported in and out with number portability. If the VoC marketing experiment is successful, demand for our mobile services may be reduced, which would negatively impact revenues and profits from that segment. On July 2, 2014, the Israeli Ministry of Communications published a tender for a mobile phone license for the provision of advanced services using 4G-LTE technology, through which a total of eight frequency bands in the area of 1,800 MHz will be allocated. HOT Mobile has submitted its offer for a part of the spectrum in response to the tender. The draft tender clarified that a licensee may enter into a network sharing agreement with another licensee, and that HOT Mobile may request to replace the deployment plan they attached to the tender for the UMTS frequencies with a deployment plan for 4G, in each case subject to certain conditions. As a result, HOT Mobile has updated its request for approval by the Ministry of Communication of the Network Agreement with Partner accordingly.

On January 12, 2015, the Israeli Ministry of Communications informed HOT Mobile that based on the results of the tender it would be awarded a frequency bandwidth of 2X5MHz in the 1.8 GHz spectrum, for a license fee of NIS 34.5 million (up to half of which may be paid by way of provision of a bank guarantee, which may be refunded, in whole or in part, upon HOT Mobile reaching certain market share milestones). The tender results will be brought before the Minister of Communications for approval. In the event that the Minister of Communications approves such additional spectrum and we decide to accept the terms on which it is offered to us, we would need to deploy 4G-LTE infrastructure within the arrangements we have entered into with Partner (which have been approved by the Israeli Antitrust Authority and are pending final approval from the Israeli Ministry of Communications) in order to commercialize such services. If we are not granted such permission or the regulatory approval for our Network Sharing Agreement with Partner is delayed, we could incur significant delays in rolling out our 4G-LTE network. Mobile service providers have been permitted to use temporary frequency bandwidth to use LTE technology until the end of the tender proceedings pursuant to which certain providers have launched LTE based services. We intend to launch such services in the coming months. Any delay in the introduction of 4G-LTE services or a failure on our part to provide such services at all could negatively affect our ability to compete with mobile operators who can provide such services to Israeli subscribers.

Multiple-play offerings. We are currently the only provider of triple-play services combining pay television, broadband Internet infrastructure access and fixed-line telephony services at a bundled price below what a subscriber would pay for each service individually. Bezeq, our principal competitor, is currently limited under its license from providing triple-play services, although it can apply for approval to the Israeli Ministry of Communications to provide such services. On March 26, 2014, the Antitrust Commissioner approved the merger between Bezeq and "YES". Therefore, we expect that Bezeq will offer such triple-play services to its customers in the near future through "YES". Bezeq can also currently provide double-play services including broadband Internet infrastructure access and ISP services at a bundled price. The ability of our competitors to provide multiple-play services in the future as a result of regulatory changes, consolidation in the industry, advances in technology or other factors, or regulatory changes that might require us to provide, on a stand alone basis, the services that currently form our triple-play bundle at the bundled rates, could have a material effect on our business, financial condition and results of operations.

On December 29, 2014, Cellcom, an Israeli telecommunication company, which also offers mobile services, announced the launch of "Cellcom TV", its new service for offering television over the internet. Cellcom TV services include the Israeli DTT broadcasting television channels, VOD services and additional advanced features and viewing capabilities. Although this service was only recently introduced (and, as such, we are unable to fully anticipate the effect that this development may have on HOT), we expect that it may increase the competition in the television services market in

which HOT currently operates, and as such could have a material effect on our business, financial condition and results of operations.

Business services. Competition in the provision of Internet, data and voice products to business customers is intense, with Bezeq, several local telephony operators through VoB and several international telephony operators among our competitors. In addition to competitive activity, we continue to see challenges in this segment of the market as a result of price erosion in existing products and the need to invest in new product development to satisfy the evolving preferences of prospective customers.

Dominican Republic

We began operations in the Dominican Republic as a result of the acquisition of Tricom (which was completed in March 2014) and ODO (which was completed in April 2014). Tricom, which provides cable and fixed line services as well as mobile services, and ODO which provides mobile services and broadband Internet services, currently face significant competition in their respective markets.

In the mobile market, ODO's and Tricom's key competitors are Claro, the incumbent with a 53% market share and Viva with a 7% market share. ODO and Tricom have recently been subject to decreasing mobile termination rates which continue to be significantly higher than in other regions such as Western Europe. While voice to data substitution resulting from increased smartphone penetration should help mitigate the impact of voice ARPU deterioration, ODO and Tricom may not be able to successfully capture wireless market share, due to competition in particular from Claro, the incumbent owned by the Mexican telecom operator America Movil with a 67% market share, and also Wind Telecom, a local wireless player with an 8% market share (as of June 2014).

Key competitors of Tricom's pay television business are Claro (approximately 26% market share), cable operator Aster (approximately 12% market share) and Wind Telecom (approximately 9% market share) (as of September 30, 2014). While the market remains relatively fragmented, significant consolidation opportunities exist, in particular between some of the smaller cable operators and we therefore expect increased competition going forward.

Concentration in the fixed telephony market is also high, with Claro and Tricom together accounting for a market share of over 90% (approximately 65% and 22% market shares, respectively) (as of December 31, 2013). However, revenues and fixed line telephony subscribers have seen declines in recent years, due to mobile substitution. These trends are in line with those witnessed in most Western European countries and are expected to continue in the future, with multiple play uptake only expected to mitigate this deterioration in part. In addition, termination rates continue to be significantly higher than in other countries, with any reductions likely to impact Tricom negatively.

Tricom and Claro are currently the only quadruple play providers in the Dominican Republic. Bundled services are expected to become increasingly important and customers that have such services are less likely to switch to a different operator for all or part of the bundled services. ODO does not currently provide bundled service and is therefore currently unable to compete in the market for bundled services, which may adversely affect its ability both to retain existing customers and to attract new customers, including those who currently subscribe for bundled services from other operators and may be disincentivised to switch operators as a result.

Further, a new mobile network operator, or "MNO," could successfully enter the mobile telecommunications market in the Dominican Republic. The entry of a new MNO in the Dominican Republic mobile telecommunications market could materially impact ODO and Tricom's market shares and have corresponding effects on their revenues and results of operations. MVNOs and resellers could also enter the Dominican Republic mobile telecommunications market, following an international trend towards increasing diversification in the telecommunications markets. In addition, ODO and Tricom are facing increasing competition from non traditional mobile voice and data services based on new mobile voice over the Internet technologies, in particular over the top ("OTT") applications, such as Skype, Google Talk and Facebook.

Portugal

In Portugal, we currently operate through our Cabovisão and ONI brands which face similar risks to those described below. Following the PT Portugal Acquisition, we will also provide telecommunication services through the PT Portugal brand. The competitive risks PT Portugal faces are described below.

Multiplay offerings. In 2008, PT Portugal launched a nationwide Pay-TV service under the "Meo" brand, primarily using its fixed network (IPTV over ADSL2+ and FTTH and direct-to-home, or DTH satellite technology). This service required PT Portugal to make significant investments in its network in order to increase the bandwidth and offer a better service quality than their competitors. In January 2013, PT Portugal announced the rebranding of "Meo" and the launch of a quadruple-play service as "M4O", offering Pay-TV broadband internet, fixed telephone and mobile telephone

services. This launch has required additional marketing expenditures and will entail ongoing investments in infrastructure to remain competitive with other market participants.

Notwithstanding gains in PT Portugal's revenues and market share from Pay-TV services in recent years and the quality of its service, PT Portugal has experienced pressure from its competitors to reduce monthly subscription fees. In addition, PT Portugal's efforts to build scale to enable it to negotiate better programming costs with content suppliers, especially certain premium content owned by one of its competitors, may not prove successful.

The competitive landscape has changed significantly in Portugal as a result of the merger in 2013 of ZON Multimédia—Serviços de Telecomunicações e Multimédia, SGPS, S.A., or ZON, the largest cable operator, and Optimus SGPS, S.A., or Optimus, the third-largest mobile operator, to create NOS SGPS, S.A. ("NOS"), a new integrated telecommunications operator in Portugal. This transaction has further increased the focus on bundled offers and the evolution from triple-play to quadruple-play services as NOS has leveraged its position as an integrated telecommunications operator and a content distributor. Cabovisão also offers triple-play services.

PT Portugal's revenues from residential services, enterprise services (where bundled offers are becoming increasingly important) and its financial position could be significantly affected if it is not successful in competing to provide these bundled services, particularly as its Pay-TV services have become increasingly important as a retention tool of its fixed line and broadband internet customers. PT Portugal's revenues from enterprise services could also be significantly affected by the competition presented by NOS, which has announced its strategy to grow its enterprise services.

Fixed-Lined Telephony. As a result of the trend toward the use of mobile services instead of fixed telephone services (mobile usage grew 63% between 2007 and 2013, whereas fixed traffic reduced by 2.5% in the same period), combined with the increase in competition from other operators, PT Portugal has experienced, and may continue to experience, erosion of market share of both access lines and of outgoing domestic and international traffic. Additionally, all mobile players have launched fixed telephony services based on their mobile networks, which are directly competing for the same customers. Competition is intensified by mobile operators NOS and Vodafone with large mobile operations but a limited (although growing) fixed line network. Mobile operators can bypass PT Portugal's international wireline network by interconnecting directly with fixed line and mobile networks either in its domestic network or abroad. Competition is also forcing down the prices of fixed line voice services for long-distance and international calls, as operators have been offering unlimited voice communications for all national and several international fixed destinations. Lowering international call prices has caused a decline in PT Portugal's revenues from international fixed line voice services. We expect competition from operators with services based on Voice over Internet Protocol, or VoIP, also to place increasing price pressure on voice tariffs. In addition, ANACOM decided to heavily reduce fixed termination fees, from €0.1114 to €0.068, effective as of October 1, 2013. This has contributed to a decrease in our revenues from fixed telephone services. The decrease in fixed line voice traffic and lower tariffs resulting from competition has significantly affected PT Portugal's overall revenues, and we expect these factors to continue to negatively affect revenues.

Broadband Internet. We believe that competition in broadband internet access in Portugal is intensifying. The intensification of competition is driven by the development of technologies such as broadband wireless access through 3G and 4G, as well as high-speed broadband supported by the deployment of a fiber optic network. PT Portugal may have increased competition from Vodafone Portugal, which intends to expand its currently limited FTTH footprint from 700,000 homes as of March 2014, to 1.5 million homes by mid-2015, as well as NOS whose high-speed broadband coverage (including HFC and FTTH) as of March 2014 was larger than that of PT Portugal. As the result of such intensified competition, PT Portugal may face additional pricing pressure on its services, which could result in the loss of revenues from both residential and enterprise customers.

Mobile Services. We believe that PT Portugal's existing mobile competitors, Vodafone and NOS, will continue to market their services aggressively, resulting in similarly priced offers for all major mobile players in the market. These aggressive pricing strategies have boosted voice and data usage at the expense of eroding retail revenues. A clear example was the launch, in 2008, of the so-called "tribal plans." Although initially designed to provide special calling and texting advantages for "restricted" user groups, their widespread success soon resulted in a significant pressure on revenues. We believe that PT Portugal's success against competitors will depend on its ability to differentiate its products based on services offered, quality, simplicity and targeting of pricing plans, and it may not be successful in doing so. We also believe quadruple-play will play a major role in the mobile Portuguese market. Although PT Portugal was the first operator to launch a quadruple-play offer, in January 2013, it will be increasingly difficult to sustain this competitive advantage, particularly following the merger resulting in the creation of NOS.

In addition, we have operations in Belgium and Luxembourg and the French Overseas Territories that face competition and competitive pressure risks similar to those described above.

A weak economy and negative economic development in Israel, Belgium, the French Overseas Territories, Luxembourg, Portugal, Switzerland and the Dominican Republic, may jeopardize our growth targets, have a material adverse effect on our business, financial condition and results of operations and significantly increase our cost of debt.

Negative developments in, or the general weakness of, the economy in Israel, Belgium, the French Overseas Territories, Luxembourg, Portugal, Switzerland or the Dominican Republic, in particular increasing levels of unemployment, may have a direct negative impact on the spending patterns of retail consumers, both in terms of the products they subscribe for and usage levels. Because a substantial portion of our revenue is derived from residential subscribers who may be impacted by these conditions, it may be (i) more difficult to attract new subscribers, (ii) more likely that certain of our subscribers will downgrade or disconnect their services and (iii) more difficult to maintain ARPUs at existing levels. In addition, we can provide no assurances that a deterioration of any of these economies will not lead to a higher number of non-paying customers or generally result in service disconnections. Similarly, a deterioration in economic conditions in the countries in which we offer B2B services (Portugal, Belgium, Luxembourg, Switzerland, the French Overseas Territories and the Dominican Republic) or wholesale services would be likely to adversely affect the demand for and pricing of such services. Therefore, a weak economy and negative economic development in the markets in which we operate may jeopardize our growth targets and may have a material adverse effect on our business, financial condition and results of operations. We are currently unable to predict the extent of these potential adverse effects. Recently, the general economic, political, labor market and capital market conditions in the EMEA region (including Israel), including certain of the jurisdictions in which we operate, and other parts of the world have undergone significant turmoil. In addition, general market volatility has resulted from uncertainty about sovereign debt and fear that the governments of countries such as Cyprus, Greece, Portugal, Spain, Ireland and Italy may default on their financial obligations. This loss of confidence led to rescue measures for Greece, Ireland and Portugal by the EU, the EBC and the IMF and a bailout of the Spanish banking sector by the EU. These issues, along with the re-pricing of credit risk and the difficulties currently experienced by financial institutions, have made it difficult for companies to obtain financing. In Portugal, government economic policy over the last three years has focused on implementing the measures agreed to as part of the €78 billion financial support package from the European Union/European Commission, the ECB and the IMF. Following an assessment of the current economic situation and future prospects, as well as the situation in the financial markets (notably the successful issuance of long-term debt), and the existence of a cash buffer that covered the government's funding needs for the 12-month period beginning May 17, 2014, the Portuguese government concluded and exited the three-year-long adjustment programme without requesting any further external financial assistance. As the result of extensive structural reforms implemented during the adjustment programme period and projected for coming years, Portuguese real GDP is forecasted by IMF to grow by 1.0% in 2014 (as compared to 1.4% decline in 2013). In 2014, the IMF expects the government deficit to remain at approximately 4.1% of GDP (as compared to 5.1% in 2013). As one of Portugal's largest companies and employers, PT Portugal's financial condition, revenues and profitability are closely linked to circumstances affecting in the Portuguese economy. The recession in Portugal has had a direct effect on demand for PT Portugal's products and services, contributing to a decline in revenues in 2011, 2012 and 2013 across most of the customer categories of PT Portugal's business. In addition, the outcome of the Portuguese general elections scheduled for September and October 2015 may results in political, economic or regulatory changes in Portugal. Furthermore, continued hostilities in the Middle East and recent tensions in North Africa could adversely affect the Israeli economy. Additionally, the Dominican Republic economy depends to a significant degree on global tourism and the health of the US economy and remains vulnerable to external shocks (e.g. economic declines in other emerging market countries). Any decrease in visitors, a downturn in the US economy or such external shocks could have a material adverse effect on economic growth in the Dominican Republic. These conditions could also adversely affect access to capital and increase the cost of capital. As a result of the disruptions in the credit markets, many lenders have increased interest rates, enacted tighter lending standards, required more restrictive terms (including higher collateral ratios for advances, shorter maturities and smaller loan amounts) or refused to refinance existing debt at all or on terms similar to pre-crisis conditions. Changes in interest rates and exchange rates may also adversely affect the fair value of our assets and liabilities. If there is a negative impact on the fair values of our assets and liabilities, we could be required to record impairment charges.

The political and military conditions in Israel may adversely affect our financial condition and results of operations.

A significant portion of our operations, our networks and some of our suppliers are located in Israel and are affected by political and military conditions. Since the establishment of the State of Israel in 1948, a number of armed conflicts have taken place between Israel and its neighboring countries. Hostilities involving Israel, any interruption or curtailment of trade between Israel and its trading partners and political instability within Israel or its neighboring countries are likely to cause our revenues to fall and harm our business. In particular, in recent conflicts, missile attacks have occurred on civilian areas, which could cause substantial damage to our networks, reducing our ability to continue serving our customers as well as our overall network capacity. In addition, in the event that recent political unrest and instability in the Middle East, including changes in some of the governments in the region, cause investor concerns resulting in a reduction in the value of the New Israeli Shekel, our expenses in non-shekel currencies may increase, with a material adverse effect on our financial results.

During an emergency, including a major communications crisis in Israel's national communications network, a natural disaster, or a special security situation in Israel, control of our networks may be assumed by a lawfully authorized person in order to protect the security of the State of Israel or to ensure the provision of necessary services to the public. During such circumstances, the government also has the right to withdraw temporarily some of the mobile spectrum granted to us. Under the Equipment Registration and Mobilization to the Israel Defense Forces Law, 1987, the Israel Defense Forces may mobilize our engineering equipment for their use, compensating us for the use and damage. This may materially harm our ability to provide services to our subscribers in such emergency circumstances and have a negative impact on our revenue and results of operations.

Moreover, the Prime Minister of Israel may, under powers which the Communications Law (Telecommunication and Broadcasting), 5742—1982 (the "Communications Law") grants him for reasons of state security or public welfare, order us to provide services to the security forces, to perform telecommunications activities and to set up telecommunications facilities required by the security forces to carry out their duties. While the Communications Law provides that we will be compensated for rendering such services to security forces, the government is seeking a change in the Communications Law which would require us to bear some of the cost involved with complying with the instructions of security forces. Such costs may be significant and have a negative impact on our revenue and results of operations.

Some of our officers and employees are currently obligated to perform annual reserve duty. All reservists are subject to being called to active duty at any time under emergency circumstances. In addition, some of our employees may be forced to stay at home during emergency circumstances in their area. We cannot assess the full impact of these requirements on our workforce and business if such circumstances arise.

More generally, any armed conflicts, terrorist activities or political instability in the region would likely negatively affect business conditions and could harm our results of operations, including following termination of such conflicts, due to a decrease in the number of tourists visiting Israel. Beginning in 2010 and continuing to date several countries in the region, including Egypt and Syria, have been experiencing increased political instability and armed conflict, which have led to change in government in some of these countries, the effects of which are currently difficult to assess. Further, tensions have increased recently between Israel and Iran over Iran's nuclear program. In the event the conflict escalates, especially if Iran has nuclear weapons capabilities, the impact on our business could be significant.

Terrorist attacks and threats, escalation of military activity in response to such attacks or acts of war may negatively affect our cash flows, results of operations or financial condition.

Our business is affected by general economic conditions, fluctuations in consumer confidence and spending, and market liquidity which can decline as a result of numerous factors outside of our control, such as terrorist attacks and acts of war. In Israel, the ongoing hostilities with the Palestinians, future terrorist attacks, rumors or threats of war, actual conflicts in which it or its allies might be involved, or military or trade disruptions affecting us or our customers may adversely affect our operations.

PT Portugal Group's revenues and EBITDA has decreased over the past years and this trend may continue.

The PT Portugal Group's revenue decreased from €2,955.3 million in 2011 to €2,769.4 million in 2012 to €2,627.4 million in 2013 and from €1,963.2 million for the nine months ended September 30, 2013 to €1,900.9 million for the nine months ended September 30, 2014. The PT Portugal Group's EBITDA decreased from €1,267.7 million in 2011 to €1,127.6 million in 2012 to €1,026.4 million in 2013 and from €775.7 million for the nine months ended September 30, 2013 to €746.6 million for the nine months ended September 30, 2014. We believe that the decrease in revenues and EBITDA of the PT Portugal Group have resulted primarily from lower revenues in the enterprise customers category as a result of cost-cutting initiatives by clients driven by the macro-economic and financial conditions in Portugal and due to lower mobile termination rates imposed by the regulator and decreases in mobile prices due to a highly competitive marketplace. We expect this trend of declining revenue and EBITDA the PT Portugal Group to be reflected in its results for the fourth quarter of 2014 and, while we expect to implement business plans and cost reduction measures to address this trend, the PT Portugal Group may continue to see declining revenue and EBITDA in the 2015 fiscal year and beyond, which could have an adverse effect on our business. The PT Portugal Group accounted for 56.2% of the pro forma consolidated revenue of the Group and 50.1% of the pro forma consolidated EBITDA of the Group for the last twelve months ended September 30, 2014.

Our growth prospects depend on a continued demand for cable based and mobile products and services and an increased demand for bundled and premium offerings.

The use of Internet, television and fixed-line telephony and mobile services in certain of the jurisdictions in which we operate has increased sharply in recent years. For example, Israel has become one of the most highly penetrated countries for such services, broadly in line with countries in Western Europe. We have benefited from this growth in recent years and our growth and profitability depend, in part, on a continued demand for these services in the coming years. We rely

on our multiple-play and premium television services in most of the jurisdictions in which we operate to attract new customers and to increase our revenue per customer by migrating existing customers to such services. Therefore, if demand for multiple-play products and premium television services does not increase as expected, this could have a material adverse effect on our business, financial condition and results of operations.

Our business is capital intensive and our capital expenditures may not generate a positive return or we may be unable or unwilling to make additional capital expenditures.

The pay television, broadband Internet, fixed-line telephony, mobile and B2B businesses in which we operate are capital intensive. Significant capital expenditures are required to add customers to our networks, including expenditures for equipment and labor costs. In Israel, we recently completed an upgrade to our cable network that made our entire network Docsis 3.0-enabled, which enables us to expand the transfer volume on the network to improve the provision of services that require substantial bandwidth like VoD and increase the number of channels that we can offer our subscribers. We are also in the process of selectively rolling out “FTTx” improvements to our last mile fixed-line network and may need to make similar capital expenditures in the future to keep up with technological advancements. In addition, we are continuing to invest in the expansion of our UMTS mobile network to provide 3G mobile services, which we launched on May 15, 2012 and which offers subscribers faster network capabilities and better roaming coverage as compared to our iDEN platform and the ability to use 3G phones. In addition, the relevant authorities in Israel have initiated an application process to award spectrum for the provision of LTE mobile telephony services. We submitted our offer in response to this tender. On January 12, 2015, the Israeli Ministry of Communications informed HOT Mobile that based on the results of the tender it would be awarded a frequency bandwidth of 2X5MHz in the 1.8 GHz spectrum, for a license fee of NIS 34.5 million (up to half of which may be paid by way of provision of a bank guarantee, which may be refunded, in whole or in part, upon HOT Mobile reaching certain market share milestones). The tender results will be brought before the Minister of Communications for approval and in case of such approval, we will need to upgrade our mobile network and roll out an LTE network, which could involve a significant amount of capital expenditure (which we expect will be made through investment in the newly formed limited partnership to be set up pursuant to the Network Sharing Agreement between HOT Mobile and Partner).

We have, in recent years, also made significant investments in cable and mobile networks in Belgium and Luxembourg, the French Overseas Territories and Portugal. PT Portugal has also made significant investments in its network, in particular in connection with the commencement of Pay-TV services in 2008 and quadruple play services in 2013. No assurance can be given that our recent or future capital expenditures will generate a positive return or that we will have adequate capital available to finance future upgrades or acquire additional licenses. If we are unable to, or elect not to, pay for costs associated with adding new customers, expanding or upgrading our networks, or making our other planned or unplanned capital expenditures, our growth and our competitive position may be materially adversely affected.

We are subject to increasing operating costs and inflation risks which may adversely affect our earnings.

While we generally attempt to increase our subscription rates to offset increases in operating costs, there is no assurance that we will be able to do so due to competitive and other factors. Therefore, operating costs may rise faster than associated revenue, resulting in a material negative impact on our cash flow and results of operations. We are also affected by inflationary increases in salaries, wages, benefits and other administrative costs which we may not be in a position to pass on to our customers, which in turn could have a material adverse effect on our business, financial condition and results of operations.

If we fail to successfully introduce new technologies or services, or to respond to technological developments, our business and level of revenue may be adversely affected and we may not be able to recover the cost of investments that we have made.

Our business is characterized by rapid technological change and the introduction of new products and services. If any new or enhanced technologies, products or services that we introduce fail to achieve broad market acceptance or experience technical difficulties, our revenue growth, margins and cash flows may be adversely affected. As a result, we may not recover investments that we make in order to deploy these technologies and services. Enhanced television, fixed-line telephony, broadband Internet infrastructure access and mobile services provided by competing operators may be more appealing to customers, and new technologies may enable our competitors to offer not only new services, but to also offer existing standard services at lower prices. See “—We face significant competition in each of the industries in which we operate and competitive pressures could have a material adverse effect on our business”. We may not be able to fund the capital expenditures necessary to keep pace with technological developments. It is possible that alternative technologies that are more advanced than those we currently provide may be developed. We may not obtain the expected benefits of our investments if more advanced technology is adopted by the market. Even if we adopt new technologies in a timely manner as they are developed, the cost of such technology may exceed the benefit to them. Our inability to obtain the funding or other resources necessary to expand or further upgrade our systems and provide advanced services

in a timely manner, or successfully anticipate the demands of the marketplace, could adversely affect our ability to attract and retain customers and generate revenue.

We anticipate that over time, new products and services we may introduce will require upgraded or new customer premises equipment, which may therefore constrain our ability to market and distribute such new services. For example, we do not expect that previously installed Internet modems or set-top boxes will be able to support all the enhancements we may introduce to our broadband Internet or pay television services over time. A portion of our subscribers will therefore require some form of upgrade or potentially a replacement of their customer premises equipment. Implementing such upgrades may entail additional costs to us and could delay the introduction of enhanced services and therefore reduce our cash flow and profitability, particularly where customers rent such customer premise equipment from us.

The deployment of fiber or VDSL2 networks by our competitors may reduce, and ultimately eliminate, the speed and power gap between our cable network and the DSL networks of our main competitors.

We believe that one of our core competitive advantages in the majority of our geographies is the strength and speed of our fiber/cable networks. On a blended basis, approximately 99.5% of the Altice International Group's networks is Docsis 3.0-enabled as of September 30, 2014. Following the PT Portugal Acquisition we will also benefit from PT Portugal's FTTH network. The parts of our networks that have been upgraded to FTTx and use Docsis 3.0 technology allow for speed levels that cannot currently be matched by xDSL networks that have not been upgraded to fiber, which is the technology deployed by most of our competitors, and allows for the connection of several devices without impairing the quality of the television signal.

However, our competitors may deploy fiber and/or VDSL2 networks allowing for download speeds and bandwidths which may rival those achieved by our network. Bezeq, through its DSL network, is the leading broadband Internet infrastructure access provider in Israel with 1.3 million subscriptions as of December 31, 2013 including business and residential customers. Bezeq has reported that, as of December 31, 2013, approximately 98% of its 1.2 million broadband internet customers have been migrated to its next generation network. On August 29, 2012, Bezeq announced its decision to broaden the deployment of optical fibers to reach as close as possible to its customers through FTTH or FTTB, in an effort to form the basis of the future supply of advanced communications services and with greater bandwidth than currently provided. In August 2013, Bezeq announced it had deployed FTTH to 200,000 households and businesses in Israel, reached 400,000 households and businesses in Israel by end of 2013, and was aiming to reach more than one million homes and businesses with fiber by the end of 2014.

In Portugal, the company formed by the combination of Zon and Optimus and which was subsequently rebranded to NOS operates the largest high-speed broadband network (including HFC and FTTH). It passed approximately 3.3 million homes as of the first quarter of 2014, of which it had approximately 68% triple-play and quadruple-play penetration. As of February 2014, NOS's 4G network covered 87.6% of the population (with 46.6% coverage at 150 Mbps). Following the merger, NOS has stated it aims to increase market share from 25% in 2012 to approximately 30% in 2018 (source: NOS Strategy Day presentation).

If our competitors deploy or significantly expand their fiber networks they may be able to compete with our pay television and broadband Internet offers at a level of quality and speed equal or superior to ours, potentially eliminating our current competitive advantage, increasing pressure on our prices and margins and leading us to incur significant capital expenditures to match their service offerings. Implementation of a VDSL2 solution by such competitors could also reduce our competitive advantage. The deployment of fiber and/or VDSL2 networks by competitors is also a risk for our B2B operations, particularly with respect to SMEs and SoHos, for which our cable and fiber/DSL networks, as applicable, are also currently an advantage. While we have invested and improved our offerings in response to fiber/VDSL2 deployment, such deployment could have a material adverse effect on our business, financial condition and results of operations.

In addition, we will need to expend significant capital expenditures to fulfill the universal service obligation and to upgrade the parts of our networks that are xDSL. There can be no assurance that we will have sufficient capital to finance such upgrades or that such upgrades will generate a positive return.

Our business may be adversely affected by actual or perceived health risks and other environmental requirements relating to exposure to electromagnetic fields through telecommunications equipment.

Exposure to electromagnetic fields through telecommunications equipment, including mobile antennas, relay antennas and WiFi, has raised concerns regarding possible harmful side effects. If concern for such risks were to worsen, or if harmful effects were scientifically established, our business, financial condition and results of operations could be materially adversely affected.

A number of studies have been conducted to examine the health effects of mobile phone use and network sites, and some of these studies have been construed as indicating that radiation from mobile phone use causes adverse health effects. Media reports have suggested that radio frequency emissions from mobile network sites, mobile handsets and other mobile telecommunication devices may raise various health concerns. While, to the best of our knowledge, the handsets that we market comply with the applicable laws that relate to acceptable Specific Absorption Rate (“SAR”) levels, we rely on the SAR levels published by the manufacturers of these handsets and do not perform independent inspections of the SAR levels of these handsets. As the manufacturers’ approvals refer to a prototype handset, and not for each and every handset, we have no information as to the actual level of SAR of the handsets along the lifecycle of the handsets. Furthermore, we only own mobile networks in Israel and the French Overseas Territories and our mobile network sites comply with the International Council on Non-Ionizing Radiation Protection standard, a part of the World Health Organization.

In May 2011, the International Agency for Research on Cancer (“IARC”), which is part of the World Health Organization (“WHO”), published a press release according to which it classified radiofrequency electromagnetic fields as possibly carcinogenic to humans based on an increased risk for adverse health effects associated with wireless phone use. We have complied with and are committed to continue to comply with the rules of the authorized governmental institutions with respect to the precautionary rules regarding the use of mobile telephones.

In June 2011, WHO published a fact sheet (no. 193) in which it was noted that “A large number of studies have been performed over the last two decades to assess whether mobile phones pose a potential health risk. To date, no adverse health effects have been established as being caused by mobile phone use”. It was also noted by WHO that “While an increased risk of brain tumors is not established, the increasing use of mobile phones and the lack of data for mobile phone use over time periods longer than 15 years warrant further research of mobile phone use and brain cancer risk in particular, with the recent popularity of mobile phone use among younger people, and therefore a potentially longer lifetime of exposure”. WHO notified that in response to public and governmental concern it will conduct a formal risk assessment of all studied health outcomes from radiofrequency fields exposure.

In Israel, the Israeli Ministry of Health published in July 2008 recommendations regarding precautionary measures when using mobile handsets. It indicated that although the findings of an international study on whether mobile phone usage increases the risk of developing certain tumors were not yet finalized, partial results of several of the studies were published, and a relationship between prolonged mobile phone usage and tumor development was observed in some of these studies. For example, we refer our customers in Israel to the precautionary rules that have been recommended by the Israeli Ministry of Health, as may be amended from time to time. These studies, as well as the precautionary recommendations published by the Israeli Ministry of Health, have increased concerns of the Israeli public with regards to the connection between mobile phone exposure and illnesses.

Several lawsuits have been filed against mobile operators and other participants in the mobile industry alleging adverse health effects and other claims relating to radio frequency transmissions to and from sites, handsets and other mobile telecommunications devices, including lawsuits against HOT, which were settled during 2012 with no material expenses incurred in such settlements.

In Portugal, the National Regulatory Authority, ICP-ANACOM (“ANACOM”) issued a regulation pursuant to Decree Law No. 11/2003, which requires entities, including PT Portugal, that are qualified to install and use radio communication stations for public broadcasting, to submit to ANACOM for approval an annual plan that monitors and measures the intensity levels of the electromagnetic waves emitted from these radio communication stations, especially stations located near the general population. Further, the Portuguese government adopted an ordinance that limits emission and exposure to electromagnetic fields with frequencies between 0 kHz and 300 GHz. Although we believe that these regulations or ordinances do not have a material impact on PT Portugal, the Portuguese government may adopt new laws or regulations regarding electromagnetic emissions and exposure, which could have an adverse effect on PT Portugal’s business.

The perception of increased health risks related to mobile network sites may also cause us increased difficulty in obtaining leases for new mobile network site locations or renewing leases for existing locations or otherwise in installing mobile telecommunication devices. If it is ever determined that health risks existed or that there was a deviation from radiation standards which would result in a health risk from sites, other mobile devices or handsets, this would have a material adverse effect on our business, operations and financial condition, including through exposure to potential liability, a reduction in subscribers and reduced usage per subscriber. Furthermore, we do not expect to be able to obtain insurance with respect to such liability.

If we cannot obtain or maintain favorable roaming or network sharing arrangements for our mobile services, our services may be less attractive or less profitable.

In November 2013 we entered into a Network Sharing Agreement with Partner Communications Company Ltd. (“Partner”) pursuant to which HOT Mobile and Partner will own equal shares of a newly formed limited partnership, which shall hold, develop and operate an advanced shared mobile network for both companies. The Network Sharing Agreement has been approved by the Israeli Antitrust Authority subject to certain conditions. One such condition is that from May 22, 2021, or six years from the date on which the final approval of the Ministry of Communications is given, whichever is earlier, the approval may be revoked if the Commissioner finds the partnership, its existence or its actions harms competition. The Network Sharing Agreement remains subject to final approval from the Israeli Ministry of Communications, the decision of which is expected to be made after the outcome of the 4G-LTE tender process is decided. Once approved, the Network Sharing Agreement will enable HOT Mobile and Partner to share antennas and frequencies and facilitate optimum utilization of the spectrum.

The Network Sharing Agreement is valid until December 31, 2028 and provides for automatic renewals in five year increments after December 31, 2028 but may be terminated in the event of a material breach and certain other specific events. In the interim, HOT Mobile has entered into a RoU Agreement with Partner which gives HOT Mobile a right of use over Partner’s mobile communication network for the purpose of providing nationwide mobile coverage to our customers. The RoU Agreement with Partner is valid until January 4, 2017. If we are unable to obtain the final approval for the Network Sharing Agreement or otherwise implement the arrangements we have entered into with Partner in a timely or cost effective manner we may be unable to achieve some or all of the anticipated benefits of these arrangements and our business and results of operations may be negatively affected. We have also entered into an agreement with Vodafone for roaming services outside Israel and which automatically renews until one of the parties gives written notice of termination and may be terminated in the event of a material breach or the commencement of liquidation or insolvency proceedings.

In Belgium, we do not own a mobile network and we rely on mobile virtual network operator agreements with BASE to provide mobile services. In addition, in the French Overseas Territories we rely on third party operators to provide international roaming services for our mobile subscribers. We cannot control the quality of the service that any such operators provide and it may be inferior to the quality of service that we provide. Equally, our subscribers may not be able to use some of the advanced features that they enjoy when making calls on our mobile network. Some of our competitors may be able to obtain lower roaming or MVNO rates than we do because they may have larger call volumes. If our competitors’ providers can deliver a higher quality or a more cost effective service, then subscribers may migrate to those competitors and our results of operation could be adversely affected. Further, we may not be able to compel providers to participate in our technology migration and enhancement strategies. As a result, our ability to implement technological innovations could be adversely affected if these providers are unable or unwilling to cooperate with the further development of our mobile networks or if they cease to provide services comparable to those we offer on our networks. Moreover, the financial terms of these agreements include a flat fee or a fee based on the actual level of consumption of mobile telephony services by our subscribers or both. In the case of flat fee contracts, even if our subscribers use low levels of mobile telephony services, we will still be charged a monthly flat fee, causing a deterioration of our operating margin. In the case of contracts which have a fee based on actual levels of consumption, if our subscribers use higher levels of mobile telephony services, we will be charged a higher fee based on such levels of consumption. As our mobile subscribers generally pay a flat subscription fee to us, higher usage patterns and hence higher fees under our contracts could put pressure on our margins. In Belgium, we have entered into a MVNO agreement with BASE to provide us with MVNO services for a period of three years (which, as such, is valid until December 2017). If we are unable to renew or replace the services provided by these operators with respect to roaming or MVNO services on favorable terms, our business and results of operations may be negatively affected.

We rely on interconnecting telecommunications providers and could be adversely affected if these providers fail to provide these services without disruption and on a consistent basis.

Our ability to provide commercially viable telephone services in the jurisdictions in which we operate depends upon our ability to interconnect with the telecommunications networks of fixed-line, mobile and international operators in such jurisdictions in order to complete calls between our subscribers and parties on a fixed-line or other mobile telephone network, as well as third parties abroad. Generally, fixed-line telephony, mobile and international operators in the jurisdictions in which we operate are obliged by law to provide interconnection to, and not to discriminate against, any other licensed telecommunications operator. We have no control over the quality and timing of the investment and maintenance activities that are necessary for these entities to provide us with interconnection to their respective telecommunications networks. In Israel, for instance, the implementation of number portability requires us to rely further on other providers, since our ability to implement number portability, provide our services and our basic ability to port numbers between operators are dependent on the manner of number portability implementation by interconnecting local operators.

The failure of these or other telecommunications providers to provide reliable interconnections to us on a consistent basis and under terms that are favorable to us could have an adverse effect on our business, financial condition or results of operations.

In addition, interconnection agreements and interconnection rates are normally subject to regulation in the jurisdictions in which we operate. In the Dominican Republic, interconnection rates are not set by the regulator but are individually negotiated by operators, however, operators must report the agreements they reach with each other to the regulator. The regulator reserves the right to intervene, if necessary, to establish prices and access to backhaul. Any changes in the interconnection rates set by the regulators may impact our results of operations. In the Dominican Republic, ODO has challenged the legality of a decision by Indotel which modified the regulation on interconnection agreements to include backhaul as an essential facility. If the Dominican Republic courts uphold the decision rendered by Indotel, ODO will have to comply with the conditions related to backhaul. It is unclear what financial implications this would have on ODO's operations.

Reduced interconnection rates have negatively affected PT Portugal's revenues for its Portuguese telecommunications businesses and will continue to do so in 2015.

In recent years, ANACOM has imposed price controls on interconnection rates for the termination of calls on mobile networks. These reductions have had a significant impact on interconnection revenues of PT Portugal's mobile subsidiary, Meo, S.A., and, consequently, on its earnings.

ANACOM has issued successive decisions that have reduced mobile termination rates over time. Most recently, in March 2012, ANACOM issued a final decision reducing mobile termination rates progressively to € 0.0127 by December 2012. The reductions in mobile termination rates have had and will continue to have a negative effect on PT Portugal's cash flows and revenues.

The Portuguese Competition Authority also completed an analysis of mobile rates for originating calls to non-geographic numbers in January 2012, finding origination rates to be excessive, and issued a recommendation that mobile operators must reduce their rates to a level reflecting their costs or face the possibility of being sanctioned. In March, 14, 2014 the Portuguese Competition Authority requested Meo, S.A. information regarding its mobile origination rates for calls to non-geographic numbers. Meo, S.A. responded to this request in April, 1, 2014 and there are no further developments since then.

With respect to the wholesale market for voice call termination on individual public telephone networks at a fixed location (Relevant Market 3), on March 7, 2013, ANACOM published a draft decision, proposing to set an average symmetrical fixed termination rate, or FTR, of €0.1091 from October 1, 2013 to July 1, 2014. This rate was calculated as the average FTR of the countries that had already notified the European Commission of their decisions with respect to their national markets based on pure Bottom Up Long-Run Average Incremental Cost, or BU-LRIC, cost models. In August 2013, after the European Commission expressed serious concerns in respect of ANACOM's draft decision, ANACOM decided to withdraw its decision and instead to impose interim and urgent measures. Under its revised measures, ANACOM determined that the maximum average prices to be adopted by operators identified as having significant market power in Relevant Market 3 should be €0.1114 per minute as of October 1, 2013, and that as of July 1, 2014, the price will be set using a pure LRIC cost model that is being developed. In November 2013, ANACOM issued a new decision imposing additional interim and urgent measures for the termination market (this decision has defined the prices PTC must adopt regarding each of the three levels of interconnection of the termination services provided and imposed similar obligations on the remaining operators who have complex prices), and launched a consultation regarding the development and implementation of a cost model for the fix termination market. On July 10, 2014, ANACOM approved (i) a draft decision regarding the definition of the fix termination wholesale market, the evaluation of significant market power in that market and the imposition, maintenance, modification and suppression of regulatory obligations in that market, and (ii) a draft decision regarding the cost model for the fixed termination market (which had been preceded by a public consultation launched in November 2013). Pursuant to Portuguese law, both draft decisions were submitted for public consultation for a period of 30 business days. We expect a final report to be published by ANACOM in the near future.

ANACOM's interconnection price controls may also negatively affect PT Portugal's revenues from fixed line residential services because it is required to reflect the reduction in these interconnection charges in our retail prices for calls from its fixed line network in Portugal. We expect ANACOM to lift these price controls following the designation of NOS as the universal service obligation, or USO, provider for fixed lines. We expect that the reduction in interconnection charges will continue to have an impact on PT Portugal's revenues from fixed line residential services in Portugal.

In addition, the lower interconnection rates have slightly reduced revenues for PT Portugal's wholesale business, which records revenues from international incoming calls transiting through its network that terminate on the networks of mobile and other fixed operators. The prices PT Portugal charge to international operators (and hence its revenues) also

depend on the interconnection fees charged by mobile and fixed operators for international incoming calls terminating on their networks, and these fees have been decreasing. We expect that lower interconnection rates will continue to have a negative impact on PT Portugal's wholesale revenues.

We rely on third parties for access to and the operation of certain parts of our network.

We are generally dependent on access to sites and land belonging to, and network infrastructure owned by, third parties, including for cable duct space and antennas used for our networks and facility space (colocation). In this respect, we have generally obtained leases, rights and licenses from network operators, including incumbent operators, governmental authorities and individuals. Our ability to offer our services to customers depends on the performance of these third parties of their obligations under such leases, licenses and rights.

If we are not able to renew our current lease agreements for these sites and/or enter into new lease agreements for suitable alternate sites, this could have a negative impact on the coverage of our network. In certain cases we are reliant on such third parties to provide installation and maintenance services, such as in Israel where we rely on our competitor and incumbent operator Bezeq to provide installation and maintenance services on certain parts of our cable network. Following the implementation of the Network Sharing Agreement with Partner, we will rely on the newly formed limited partnership (in which HOT Mobile and Partner shall each hold an equal share), which will hold, develop and operate an advanced shared mobile network for both companies.

If third parties refuse to or only partially fulfil their obligations under or terminate the licenses granted to us or prevent the required access to certain or all of such sites, it could prevent or delay the connection to sites or customers, limit the growth of our offerings and influence our ability to supply high quality service to our customers in a timely and cost effective manner. In addition, the costs of providing services is dependent on the pricing and technical terms under which we are given such access and any change in such terms may have a material adverse effect on our business. In many cases, we may not be able to find suitable alternatives at comparable cost or within a reasonable timeframe.

If we are unable to obtain attractive programming on satisfactory terms for our pay television services, the demand for these services could be reduced, thereby lowering revenue and profitability.

The success of our basic and premium pay television services depends on access to an attractive selection of television programming from content providers. The ability to provide movie, sports and other popular programming, including VOD content, is a major factor that attracts subscribers to pay television services, especially premium services.

We rely on digital programming suppliers for a significant portion of our programming content and VOD services. We may not be able to obtain sufficient high-quality programming from third party producers for our digital cable television services on satisfactory terms or at all in order to offer compelling digital cable television services. In addition, we also rely on certain of our competitors for the provision of certain content offerings. Further, with respect to our operations in Israel, we cannot assure you that the local content we are required to develop in conjunction with our partner studios will continue to be successful. The inability to obtain high-quality content, may also limit our ability to migrate customers from lower tier programming to higher tier programming, thereby inhibiting our ability to execute our business strategy. In addition, we are currently subject to "must carry" requirements in certain of the jurisdictions in which we operate that may consume channel capacity otherwise available for other services. Any or all of these factors could result in reduced demand for, and lower revenue and profitability from, our digital cable television services.

Also, some of our programming contracts require us to pay prices for the programming based on a guaranteed minimum number of subscribers, even if that number is larger than the number of actual subscribers. In addition, some of our programming contracts are based on a flat fee irrespective of the popularity of the content purchased under such contract. As a result, if we misjudge anticipated demand for the programming or if the programming we acquire does not attract the number of viewers we anticipated, the profitability of our television services may be impaired.

In addition, program providers and broadcasters may elect to distribute their programming through other distribution platforms, such as satellite platforms, digital terrestrial broadcasting or IPTV, or may enter into exclusive arrangements with other distributors.

Furthermore, as we purchase a significant portion of our content from various content providers under relatively short-term contracts, the prices we pay to purchase such content are subject to change and may increase significantly in the future, which could have a material adverse effect on our results of operations.

An increase in the rate of our annual royalty or other payments with respect to our licenses could adversely affect our results of operations.

We are required to make certain royalty payments to the State of Israel in connection with our domestic license with respect to our broadband Internet and fixed-line services, our broadcasting license, our mobile license and our international long distance telephony services. See “*Regulatory—Israel—Broadband Internet Infrastructure Access and Fixed-Line Telephony—Fees and Royalty Payments*”. In Israel, although the royalty payments due to the Israeli Ministry of Communication have decreased in recent years and have been reduced to zero with effect from January 2013, there is no assurance that the Israeli Ministry of Communications would not reinstate or increase them in the future. We are still required to make annual payments until January 2015, to the State of Israel for the use of cable infrastructure. In Portugal, we are required to pay certain fees to the regulatory authority to cover certain costs of such authority that are allocated amongst the telecommunications operators, such as an annual fee calculated considering our turnover in the telecommunications sector, as well as annual fees for number usage and for frequency usage. We are also required to pay fees for number allocation, for frequency allocation and for certain declarations of rights, among other fees. If the Israeli Ministry of Communications and the Israeli Ministry of Finance or the relevant government authorities in Portugal or in the other jurisdictions in which we operate increase the royalty or other payments we are required to make pursuant to our licenses or otherwise, it may have a material effect on our revenue and results of operations.

We depend on hardware, software and other providers of outsourced services, who may discontinue their services or products, seek to charge us prices that are not competitive or choose not to renew contracts with us.

We have important relationships with several suppliers of hardware, software and related services that we use to operate our pay television, broadband Internet, fixed-line telephony, mobile and B2B businesses. In certain cases, we have made substantial investments in the equipment or software of a particular supplier, making it difficult for us to quickly change supply and maintenance relationships in the event that our initial supplier refuses to offer us favorable prices or ceases to produce equipment or provide the support that we require. For example, while we continue to promote a rapid take up of our premium triple-play services, which combines premium television services including, VOD functionality, HD technology and recording capabilities, very high-speed Internet and fixed-line telephony, using a single set-top box in several of our geographies including Portugal, Belgium and Luxembourg and Israel, we face potential risks in securing the required customer set-top box equipment to maintain this roll out as we currently rely on a single provider to provide us with such equipment. Currently, we have a sufficient supply of these boxes available, but a future shortage may involve significant delays in seeking an alternative supply, may constrain our ability to meet customer demand and may result in increased customer churn. Further, in the event that hardware or software products or related services are defective, it may be difficult or impossible to enforce recourse claims against suppliers, especially if warranties included in contracts with suppliers have expired or are exceeded by those in our contracts with our subscribers, in individual cases, or if the suppliers are insolvent, in whole or in part. In addition, there can be no assurances that we will be able to obtain the hardware, software and services we need for the operation of our business, in a timely manner, at competitive terms and in adequate amounts. In particular, in the case of an industry-wide cyclical upturn or in the case of high demand for a particular product, our suppliers of software, hardware and other services may receive customer orders beyond the capacity of their operations, which could result in late delivery to us, should these suppliers elect to fulfil the accounts of other customers first. We have, from time to time, experienced extensions of lead times or limited supplies due to capacity constraints and other supply-related factors, as well as quality control problems with service providers. We may also not be able to recover monies paid to such suppliers or obtain contractual damages to which we may be entitled (if any) in the event our suppliers fail to comply with their obligations in a timely manner.

We also outsource some of our support services, including parts of our subscriber services, information technology support, technical services, and maintenance operations. Should any of these arrangements be terminated by either contract party, this could result in delays or disruptions to our operations and could result in us incurring additional costs, including if the outsourcing counterparty increases pricing or if we are required to locate alternative service providers or in-source previously outsourced services.

Further, we are dependent on certain suppliers with respect to our mobile services in Israel who we may not be able to replace without incurring significant costs. With respect to our 3G mobile operations, we have engaged NSN Nokia Solutions and Networks (“NSN”) as a turnkey contractor to plan and build the new UMTS network. With respect to our iDEN-based mobile services, we are dependent on Motorola Solutions which, to the best of our knowledge, holds all the rights to and is the sole provider of infrastructure equipment and end-user equipment for this technology. A cessation or interruption in the supply of the products and/or services by NSN or Motorola Solutions may harm our ability to provide our mobile services to our subscribers.

Our ability to renew our existing contracts with suppliers of products or services, or enter into new contractual relationships, with these or other suppliers, upon the expiration of such contracts, either on commercially attractive terms, or at all, depends on a range of commercial and operational factors and events, which may be beyond our control. The occurrence of any of these risks or a significant disruption in our supply of equipment and services from key sourcing partners could create technical problems, damage our reputation, result in the loss of customer relationships and have a material adverse effect on our business, financial condition and results of operations.

Failure in our technology or telecommunications systems could significantly disrupt our operations, which could reduce our customer base and result in lost revenue.

Our success depends, in part, on the continued and uninterrupted performance of our information technology and network systems as well as our customer service centers. The hardware supporting a large number of critical systems for our cable networks and mobile networks is housed in a relatively small number of locations. Our systems are vulnerable to damage from a variety of sources, including telecommunications failures, power loss, malicious human acts and natural disasters. Moreover, despite security measures, our servers are potentially vulnerable to physical or electronic break-ins, computer viruses and similar disruptive problems. Despite the precautions we have taken, unanticipated problems affecting our systems could cause failures in our information technology systems or disruption in the transmission of signals over our networks. Sustained or repeated system failures that interrupt our ability to provide service to our customers or otherwise meet our business obligations in a timely manner would adversely affect our reputation and result in a loss of customers and revenues.

If any part of our cable or mobile networks, including our information technology systems, is subject to a flood, fire or other natural disaster, terrorism, acts of war, a computer virus, a power loss, other catastrophe or unauthorized access, our operations and customer relations could be materially adversely affected. For example, although our cable networks are generally built in resilient rings to ensure the continuity of network availability in the event of any damage to its underground fibers, if any ring is cut twice in different locations, transmission signals will not be able to pass through, which could cause significant damage to our business. In the event of a power outage or other shortage, we do not have a back-up or alternative supply source for all of our network components. The occurrence of any such event could cause interruptions in service or reduce capacity for customers, either of which could reduce our revenue or cause us to incur additional expenses. In addition, the occurrence of any such event may subject us to penalties and other sanctions imposed by regulators such as the Portuguese telecommunications regulator (the *Autoridade Nacional das Comunicações*, or ANACOM) (in the case of our businesses in Portugal). Further, we may incur costs and revenue losses associated with the unauthorized use of our networks, including administrative and capital costs associated with the unpaid use of our networks as well as with detecting, monitoring and reducing the incidences of fraud. Fraud also impacts interconnect costs, capacity costs, administrative costs and payments to other carriers for unbillable fraudulent roaming charges.

Additionally, our businesses are also dependent on certain sophisticated critical systems, including our switches, billing and customer service systems, which could be damaged by any of the aforementioned risks. For example, if we experience problems in the operation of our billing systems, it may be difficult to resolve the issue in a timely and cost effective manner. In addition, the hardware that supports our switches, billing and customer service systems is housed in a relatively small number of locations and if damage were to occur to any of such locations, or if those systems develop other problems, it could have a material adverse effect on our business. Moreover, we may incur liabilities and reputational damages to the extent that any accident or security breach results in a loss of or damage to customers' data or applications, or inappropriate disclosure of confidential information. Additionally, we rely on hardware, software, technical services and customer support provided by third parties. We do not control the proper functioning of such third party equipment, and to the extent hardware, software, technical services and customer support provided by third parties fails, our business operations may be adversely affected.

As the number of our customers and the services that we offer our customers increases, the complexity of our product offerings and network architecture also increases, as does network congestion. A failure to manage the growth and complexity of our networks could lead to a degradation of service and network disruptions that could harm our reputation and result in a loss of subscribers. In Israel, any delays or technical difficulties in establishing our UMTS network may affect our results of operations. Further, although many of our products and services are built on standardized platforms, they have been adapted or tailored to our networks and the offerings we have designed, as a result of which we face the risk of any newly implemented technology that there may be unexpected operational issues that arise. If we were to experience a breakdown of equipment or technology that we cannot timely repair, we might lose subscribers.

We are not generally insured against war, terrorism (except to a limited extent under our general property insurance) and cyber risks and do not generally insure the coaxial portion of our network. Any catastrophe or other damage that affects any of our networks in the jurisdictions in which we operate could result in substantial uninsured losses. In addition, disaster recovery, security and service continuity protection measures that we have or may in the future undertake, and

our monitoring of network performance (including in Israel from our network operating center in Yakum), may be insufficient to prevent losses.

In addition, although so far no incidents have occurred in numbers that are statistically significant, our technical equipment has been and may continue to be subject to occasional malfunctioning due to technical shortcomings or imperfect interfaces with equipment in private homes, the networks of other operators or our own network or with other surrounding equipment. We might incur liabilities or reputational damages as a result thereof.

Our reputation and financial condition may be affected by product quality issues, in particular in connection with LaBox.

Many of our products and services, including LaBox which we have rolled out in Belgium, Luxembourg, Portugal and Israel, are manufactured and maintained through complex and precise technological processes. These complex products may contain defects or experience failures when first introduced or when new versions or enhancements to existing products are released. We cannot guarantee that, despite testing procedures, errors will not be found in new products, including LaBox, after launch. Such errors could result in a loss of, or a delay in market acceptance of our products, increased costs associated with customer support, delay in revenue recognition or loss of revenues, writing down the inventory of defective products, replacement costs, or damage to our reputation with our customers and in the industry. Any such error could also require a software solution that would cure the defect but impede performance of the product. In addition, any loss of confidence by customers in us may cause sales of our other products to drop significantly. Furthermore, we may have difficulty identifying customers whose products are defective. As a result, we could incur substantial costs to implement modifications and correct defects. Any of these problems could materially adversely affect our results of operations.

Customer churn, or the threat of customer churn, may adversely affect our business.

Our ability to attract and retain subscribers to our cable based and mobile services or to increase profitability from existing subscribers will depend in large part on our ability to stimulate and increase subscriber usage, convince subscribers to switch from competitors' services to our services and our ability to minimize customer "churn". Customer churn is a measure of the number of customers who stop subscribing for one or more of our products or services. Churn arises mainly as a result of competitive influences, introduction of new products and technologies, deterioration of personal financial circumstances, price increases and regulatory developments. In Israel, the regulatory framework prohibits, among other things, cable based service providers and mobile operators from charging exit fees, except in limited circumstances, to subscribers who wish to terminate their services and mobile operators from selling locked handsets or linking the terms of sale of handsets to the terms of mobile services, including discounts and other benefits, which has increased churn rates for many cable based service providers and mobile operators. If we fail to effectively communicate the benefits of our networks through our marketing advertising efforts, we may not be able to attract new customers and our efforts to attract and retain customers may prove unsuccessful. With the launch of our UMTS network in 2012, our mobile churn rate in Israel increased from historical levels as 3G mobile services generally have a higher churn rate than iDEN mobile services. In addition, any interruption of our services or the removal or unavailability of programming, which may not be under our control, could contribute to increased customer churn. Further our competitors may improve their ability to attract new customers, for example by offering new product bundles or product offerings at lower prices than us, which would make it difficult for us to retain our current subscribers, and the cost of retaining and acquiring new subscribers could increase. In Portugal, we experienced increase churn in recent periods mainly as a result of aggressive competition and the adverse economic conditions. In addition, our B2B operations are also subject to "tariff churn" (i.e., an existing customer negotiating tariff decreases). Large corporate customers in particular are highly sophisticated and often aggressive in seeking to renegotiate the pricing of their contracts which tends to result in margin pressure. Increased customer or tariff churn may have a material adverse effect on our business, financial condition and results of operation.

Acquisitions and other strategic transactions present many risks including the risk that we may not be able to integrate newly acquired operations into our business, which may prevent us from realizing the strategic and financial goals contemplated at the time of any such transaction and thus adversely affect our business.

Historically, our business has grown, in part, through a significant number of selective acquisitions that enabled us to take advantage of existing networks, service offerings and management expertise. Since 2010, we have acquired the HOT telecommunications group in Israel, Cabovisão and ONI in Portugal, Outremer, Telecom and Mobius in the French Overseas Territories, Tricom and ODO in the Dominican Republic, as well as majority controlling equity interests in Coditel with operations in Belgium and Luxembourg. On December 9, 2014, we entered into an agreement with Oi S.A. to purchase 100% of the issued share capital of PT Portugal. The PT Portugal Acquisition is subject to certain conditions including regulatory approval in Portugal and merger-control clearance by the European Commission (or from the Portuguese Competition Authority, under the referral mechanism set forth in the EU merger control rules). We expect to

continue growing our business through acquisitions of cable and telecommunications businesses that we believe will present opportunities to create value by generating strong cash flows and operational synergies.

Any acquisition or other strategic transaction we may undertake in the future could result in the incurrence of debt and contingent liabilities and an increase in interest expenses and amortization expenses related to goodwill and other intangible assets or in the use by us of available cash on hand to finance any such acquisitions. We may experience difficulties in integrating acquired operations into our business, incur higher than expected costs and not realize all the anticipated benefits or synergies of these acquisitions, if any. Such transactions may also disrupt our relationships with current and new employees, customers and suppliers. In addition, our management may be distracted by such acquisitions and the integration of the acquired businesses. Thus, if we consummate any further acquisitions or fail to integrate any previous acquisitions, there could be a material adverse effect on our business, financial condition or results of operations. In addition, our debt burden may increase if we borrow funds to finance any future acquisition, which could have a negative impact on our cash flows and our ability to finance our overall operations. If we use available cash on hand to finance acquisitions pursuant to our acquisition strategy, our ability to make dividend payments may be limited or we may not be able to make such dividend payments at all. There can be no assurance that we will be successful in completing business acquisitions or integrating previously acquired companies.

There can be no assurance that we will receive the required governmental approvals and meet the other conditions required to consummate the PT Portugal Acquisition. Furthermore, acquisitions of additional telecommunications companies may require the approval of governmental authorities (either at country or, in the case of the EU, European level), which can block, impose conditions on, or delay the process which could result in a failure on our part to proceed with announced transactions on a timely basis or at all, thus hampering our opportunities for growth. In the event conditions are imposed and we fail to meet them in a timely manner, the relevant governmental authority may impose fines and, if in connection with a merger transaction, may require restorative measures, such as mandatory disposition of assets or divestiture of operations. In connection with the acquisition of SFR by Numericable-SFR S.A. (which is controlled by our parent Altice S.A., and therefore an affiliate of the Group), we have entered into a commitment with the French Competition Authority to dispose of our mobile network assets in Mayotte and La Réunion (which are part of our Group's business in the French Overseas Territories). If this disposal is not completed by mid-2015, we are committed to appoint an independent agent (who must be approved by the French Competition Authority) to complete such disposal. Further, we have undertaken to ensure that such mobile assets in La Réunion and in Mayotte are managed independently from the other activities of Numericable Group (including those of SFR) prior to such disposal.

Although we analyze and conduct due diligence on acquisition targets, our assessments are subject to a number of assumptions concerning profitability, growth, interest rates and company valuations and our inquiries may fail to uncover relevant information. There can be no assurance that our assessments or due diligence of and assumptions regarding acquisition targets will prove to be correct, and actual developments may differ significantly from our expectations. Moreover, our plans to acquire additional businesses in the future are subject to the availability of suitable opportunities. Our competitors may also follow similar acquisition strategies and may have greater financial resources available for investments or may be willing to accept less-favorable terms than we can accept, which may prevent us from acquiring the businesses that we target to the benefit of our competitors.

We may be unable to allocate sufficient managerial and operational resources to meet our needs as our business grows, and our current operational and financial systems and managerial controls and procedures may become inadequate.

Historically, our business has grown, in part, through selective acquisitions. As a result, the operating complexity of our business, as well as the responsibilities of management, has increased, which may place significant strain on our managerial and operational resources.

Although we consider the operational and financial systems and the managerial controls and procedures that we currently have in place to be adequate for our purposes, we recognize that the effectiveness of these systems, controls and procedures needs to be kept under regular review as our business grows. We will have to maintain close coordination among our logistical, technical, accounting, finance, marketing and sales personnel. Management of growth will also require, among other things, continued development of financial and management controls and information technology systems. The constant growth and increased international operations may strain our managerial resources which may require us to hire additional managerial resources. We may be unable to hire managers with the relevant expertise or the hiring process may require significant time and resources, all of which could result in a disruption in our management, growth, operational and financial systems, managerial controls and procedures and results of operations.

Any failure to apply the necessary managerial and operational resources to our growing business and any weaknesses in our operational and financial systems or managerial controls and procedures may impact our ability to produce reliable financial statements and may adversely affect our business, financial condition and results of operations.

Pressure on customer service could adversely affect our business.

The volume of contacts handled by our customer service functions can vary considerably over time. The introduction of new product offerings can initially place significant pressure on our customer service personnel. Increased pressure on such functions is generally associated with decreased satisfaction of customers.

In the B2B and wholesale markets, customers require service to be extremely reliable and to be reestablished within short timeframes if there is any disruption. Penalties are often payable in the case of failure to meet expected service quality. In addition, product installation can be complex, requiring specialized knowledge and expensive equipment. Delays and service problems may result in both penalties and the potential loss of customers. In these segments, we rely on our experienced customer relations personnel to handle any customer issues or requests, and the loss of such personnel can result in the loss of customers.

We have in the past experienced significant levels of customer dissatisfaction as a result of operational difficulties. Improvements to customer service functions may be necessary to achieve desired growth levels, and, if we fail to manage such improvements effectively and achieve such growth, we may in the future experience customer service problems and damage our reputation, contribute to increased churn and/or limit or slow our future growth.

Revenue from certain of our services is declining, and we may be unable to offset this decline.

We continue to provide analog television services to subscribers in all of our geographies where we provide pay television services but expect that the number of subscribers to such services will continue to decline and that such services will ultimately be phased out. Furthermore, our analog television subscribers may decide, upon their transition to a digital television service, to shift to other providers of television services.

Disruptions in the credit and equity markets could increase the risk of default by the counterparties to our financial instruments, undrawn debt facilities and cash investments and may impact our future financial position.

Although we seek to manage the credit risks associated with our financial instruments, cash and cash equivalents and undrawn debt facilities, disruptions in credit and equity markets could increase the risk that our counterparties could default on their obligations to us. Were one or more of our counterparties to fail or otherwise be unable to meet its obligations to us, our cash flows, results of operations and financial condition could be adversely affected. It is not possible to predict how disruptions in the credit and equity markets and the associated difficult economic conditions could impact our future financial position. In this regard, (i) the financial failures of any of our counterparties could (a) reduce amounts available under committed credit facilities and (b) adversely impact our ability to access cash deposited with any failed financial institution and (ii) sustained or further tightening of the credit markets could adversely impact our ability to access debt financing on favorable terms, or at all.

Our brands are subject to reputational risks.

The brands under which we sell our products and services, including HOT, Cabovisão, ONI, Only, Orange Dominicana and Tricom are well-recognized brands in Israel, Belgium and Luxembourg, Portugal, the French Overseas Territories and the Dominican Republic, as applicable. We have developed the brands we use through extensive marketing campaigns, website promotions, customer referrals, and the use of a dedicated sales force and dealer networks. Upon completion of the PT Portugal Acquisition, brands including *Meo* will be added to our portfolio.

Our brands represent a material and valuable asset to us. Although we try to manage our brands, we cannot guarantee that our brands will not be damaged by circumstances that are outside our control or by third parties such as hackers, sponsors, or interfaces with its clients, such as subcontractors' employees or sales forces, with a resulting negative impact on our activities. In particular, our image is increasingly tied to LaBox, an innovative set-top box we source from a third-party supplier.

A failure on our part to protect our image, reputation and the brands under which we market our products and services may have a material adverse effect on our business and results of operations.

Our business may suffer if we cannot continue to license or enforce the intellectual property rights on which our business depends.

We rely on patent, copyright, trademark and trade secret laws and licenses and other agreements with our employees, customers, suppliers and other parties to establish and maintain our intellectual property rights in content, technology and products and services used to conduct our businesses. However, our intellectual property rights or those of our licensors could be challenged or invalidated, we could have difficulty protecting or obtaining such rights or the rights may not be

sufficient to permit us to take advantage of business opportunities, which could result in costly redesign efforts, discontinuance of certain product and service offerings or other competitive harm.

We have been, and may be in the future, subject to claims of intellectual property infringement, which could have an adverse impact on our business or operating results.

We have received and may receive in the future claims of infringement or misappropriation of other parties' proprietary rights, particularly creative rights with respect to broadcasted programs. In addition to claims relating to broadcasts on channels which we own, we may be subject to intellectual property infringement claims with respect to programs broadcast on the other channels, including foreign channels that we carry. These claims may require us to initiate or defend protracted and costly litigation, regardless of the merits of these claims. Generally, law relating to intellectual property contains provisions allowing the owner of an intellectual property right to apply to courts to grant various enforcement measures and other remedies, such as temporary and permanent injunctive relief, a right to confiscate infringing goods and damages. Successful challenges to our rights to intellectual property or claims of infringement of a third party's intellectual property could require us to enter into royalty or licensing agreements on unfavorable terms, incur substantial monetary liability or be temporarily or permanently prohibited from further use of the intellectual property in question. This could require us to change our business practices and limit our ability to provide our customers with the content that they expect. If we are required to take any of these actions, it could have an adverse impact on our businesses or operating results. Even if we believe that the claims of intellectual property infringement are without merit, defending against the claims can be time-consuming and costly and divert management's attention and resources away from its businesses.

The operation of our conditional access systems is dependent on licensed technology and subject to illegal piracy risks.

We operate conditional access systems to transmit encrypted digital programs, including our digital pay television packages. For example, in Israel, we are party to an agreement with NDS Limited, pursuant to which NDS Limited has agreed to sell and install parts of our conditional access system for our cable distribution, including hardware equipment, to grant licenses for the respective intellectual property rights for the conditional access system and to provide maintenance, support and security services. We are currently in the process of reviewing our contractual arrangements with NDS Limited for the provision of these products and services. We are also party to similar agreements with Cisco, the parent company of NDS Limited, across our other operations. Billing and revenue generation for our services rely on the proper functioning of our conditional access systems.

Even though we require our conditional access system providers to provide state-of-the-art security for the conditional access systems, the security of our conditional access systems may be compromised by illegal piracy and other means. In addition, our set top boxes require smart cards before subscribers can receive programming and our smart cards have been and may continue to be illegally duplicated, providing unlawful access to our television signals. While we work diligently to reduce the effect of piracy, there can be no assurance that we will be able to successfully eliminate the piracy we currently face. In addition, there can be no assurance that any new conditional access system security that we may put in place will not be circumvented. Encryption failures could result in lower revenue, higher costs and increased basic cable subscriber churn or otherwise have a material adverse effect on our business, financial condition and results of operations.

We collect and process subscriber data as part of our daily business and the leakage of such data may violate laws and regulations which could result in fines, loss of reputation and subscriber churn and adversely affect our business.

We accumulate, store and use data in the ordinary course of our operations that is protected by data protection laws. Regulatory authorities in the jurisdictions in which we operate our businesses have the right to audit us and impose fines if they find we have not complied with applicable laws and adequately protected customer data. Although we take precautions to protect subscriber data in accordance with the applicable privacy requirements in the jurisdictions in which we operate, we may fail to do so and certain subscriber data may be leaked or otherwise used inappropriately. We work with independent and third party sales agents, service providers and call center agents, and although our contracts with these third parties generally restrict the use of subscriber data, we can provide no assurances that they will abide by the contractual terms or that the contracts will be found to be in compliance with data protection laws. Violation of data protection laws may result in fines, loss of reputation and subscriber churn and could have an adverse effect on our business, financial condition and results of operations. There can be no guarantee that our assessment of risk will be accurate or that provisions made will be sufficient.

We are exposed to, and currently engaged in, a variety of legal proceedings, including several existing and potential class action lawsuits in Israel and antitrust proceedings in Portugal.

In addition to a number of legal and administrative proceedings arising in the ordinary course of our business, we have been named as defendants in a number of civil proceedings related to our cable and mobile services, which may result in civil liabilities against us or our officers and directors. These include, amongst others, consumer claims regarding, for example, our tariff plans and billing methods and claims by competitors, which may result in significant monetary damages and civil penalties. The costs that may result from these lawsuits are only accrued when it is more likely than not that a liability, resulting from past events, will be incurred and the amount of that liability can be quantified or estimated within a reasonable range. The amount of the provisions recorded in our historical consolidated financial statements as of December 31, 2013 in respect of each lawsuit, which in the aggregate amounted to €18 million, is based on a case-by-case assessment of the risk level of each individual lawsuit, and events arising during the course of legal proceedings may require a reassessment of this risk. Our assessment of risk is based both on the advice of legal counsel and on our estimate of the probable settlement amounts that are expected to be incurred, if such a settlement will be agreed by both parties.

In January 2011, the European Commission opened an investigation into an agreement between Telefonica and Portugal Telecom SGPS, allegedly not to compete in the Iberian telecommunications markets. In January 2013, the EC adopted a decision finding that Portugal Telecom SGPS and Telefonica had infringed Article 101 of the Treaty on the Functioning of the European Union with reference to Portugal Telecom's July 28, 2010, agreement with Telefónica concerning the acquisition by Telefonica of Portugal Telecom's SGPS stake in Brazilian operator Vivo. In accordance with this decision, Portugal Telecom SGPS was fined in the amount of €12.29 million. The January 2013 decision ended the investigation which began in January 2011, in which the European Commission analysed the relationship between both companies since 1996.

On April 9, 2013, Portugal Telecom SGPS brought an action for annulment before the General Court of European Union (the first level of appeal of the EU courts) and will continue to vigorously defend the matter. The matter is now waiting to be tried before the General Court. We note that the EU appeal courts have unlimited jurisdiction to review decisions where the EC has fixed a fine (including cancelling, reducing or increasing the fine).

Although the European Commission's decision was addressed to Portugal Telecom SGPS PT Moveis, SGPS, S.A. was expressly mentioned in the decision as being involved in the alleged infringement (even though it is not the addressee of the European Commission decision). Portugal Telecom SGPS is therefore solely responsible for the payment of the fine. While the appeal is pending the payment of the fine was secured with a bank guarantee (with an initial term of one year that is automatically extended for additional periods of one year each). While this bank guarantee is in place, the European Commission will not enforce their decision in order to collect the fine. Accordingly, no provision has been recorded with regards to this matter.

In Israel, plaintiffs in these proceedings are often seeking certification as class actions. These claims are generally for significant amounts and may require us to initiate or defend protracted and costly litigation, regardless of the merits of these claims.

If any of these claims or claims that may arise in the future succeed, we may be forced to pay damages or undertake other actions which could affect our business and results of operations. See "*Description of our Business—Legal Proceedings*" and "*Description of PT Portugal's Business—Legal Proceedings*".

There are uncertainties about the legal framework under which we own and operate our network in Belgium and Luxembourg.

In Belgium and in Luxembourg, we built our network pursuant to agreements which we entered into during the 1960s and the 1970s with municipalities which authorized us to build and operate a television cable network in their territory. Since then, the regulatory framework has changed. In particular, the right of certain of the municipalities to receive royalty payments in consideration for the grant of the authorization, to reclaim ownership of the network and to regulate the prices at which we offer our services are arguably incompatible with the liberalization of the telecommunications market within the European Union. These uncertainties are compounded by the fact that the national laws adopted to implement European Union directives did not necessarily deal with these issues, that these agreements were sometimes renewed after the new regulatory regime was entered into force but were not amended to reflect such changes and by the lack of authoritative case law on the subject creating uncertainties as to the status of these networks and the rights of the different interested parties. Furthermore, there is no uniformity among these agreements. These uncertainties have led to litigation, including with the Roeser and Junglinster municipalities in Luxembourg which are currently pending on appeal. See "*Description of our Business—Legal Proceedings*".

If we were to lose what we believe is the ownership of our network and our right to operate it in such litigation or in any new litigation, or because of any new law or regulation that would be favorable to the municipalities' claims, this would have a material adverse effect on our business, results of operations and financial condition.

Unfunded post retirement benefits obligations may put PT Portugal at a disadvantage to its competitors and could adversely affect our financial performance.

Following the PT Portugal Acquisition, PT Portugal will become a part of the Group. PT Portugal has unfunded post retirement benefits obligations that may limit its future use and availability of capital and adversely affect its financial and operating results. Although in December 2010, PTC transferred to the Portuguese government the post retirement benefits obligations relating to regulated pensions of Caixa Geral de Aposentações and Marconi, it retained all other obligations, including (1) salaries to suspended and pre-retired employees amounting to €808.1 million as of September 30, 2014, which PT Portugal must pay monthly directly to the beneficiaries until their retirement age and (2) €516.4 million in obligations related to pension supplements and healthcare as of September 30, 2014, which are backed by plan assets with a market value of €252.6 million, resulting in unfunded obligations of € 1,071.8 million as of September 30, 2014.

Any decrease in the market value of PT Portugal's plan assets relating to its pension supplements and healthcare obligations could increase its unfunded position. Although there is an investment policy in place with capital preservation targets, in the current economic and financial crisis, in particular, the market value of its plan assets is volatile and poses a risk. In addition, PT Portugal's obligations to pay salaries to suspended and pre-retired employees are unfunded. The value of the obligations referred to above may also fluctuate, depending on demographic, financial, legal or regulatory factors that are beyond our control. For example, the Portuguese government has recently announced that the retirement age will be raised to 66 in 2015 and 66 and two months in 2016 and may raise it further in the future. A rise in the retirement age would increase our obligations to pay salaries to suspended and pre-retired employees. Any significant increase in PT Portugal's unfunded obligations could adversely affect its ability to raise capital, require it to use cash flows that it would otherwise use for capital investments, implementing its strategy or other purposes and adversely affect perceptions of its overall financial strength.

See "Management's Discussion and Analysis of the Financial Conditions of the PT Portugal Group—Post Retirement Benefits" for a description of PT Portugal's transfer of pension obligations to the Portuguese government.

PT Portugal and PT OpCo have significant post-retirement benefit and healthcare obligations that may, in some cases, rank senior to the guarantees of the New Notes and our other existing debt that that benefit from guarantees from these companies. In addition, recoveries from these companies are subject to the Aggregate Portuguese Security and Guarantee Limit.

As of September 30, 2014, the projected benefits obligations of PTC's post-retirement benefits, including pension supplements, healthcare benefits and salaries payable to pre-retired and suspended employees amounted to €1,316.4 million (€112.9 million for pension supplements, €402.0 million for healthcare benefits and € 801.5 million for salaries payable to pre-retired and suspended employees). Salaries payable to pre-retired and suspended employees are obligations under individual agreements with employees to pay employees a significant portion of their existing salary to not work (or work part-time) until retirement.

The market value as of September 30, 2014 of the funds related to PTC's pension supplements and healthcare benefits amounted to €94.2 million and €158.5 million. In Portugal, there is no legislation on the establishment of funds to cover the healthcare obligations and the salaries for pre-retired and suspended employees, and PTC (and now PT OpCo) is required to pay for these benefits only when the salaries are paid to pre-retired and suspended employees, or when healthcare expenses are incurred. Accordingly, there is no requirement to fund these benefits obligations at present. Although the PT Portugal Group has set up a fund managed by a subsidiary, PT Prestações—Mandatária de Aquisições e Gestão de Bens, S.A., or PT Prestações, to finance the Group's healthcare post-retirement liabilities, no similar fund has been established to pay salaries owed to pre-retired and suspended employees.

As a general rule, Portuguese law ranks creditor claims in an insolvency in the following order:

1. secured claims (up to the amount of the secured assets, with any excess amounts being treated as common claims);
2. privileged claims, including certain claims resulting from employment contracts;
3. common claims (general unsecured claims); and
4. subordinated claims, including claims of affiliates and shareholders.

Notwithstanding the foregoing, certain claims, such as court costs of the insolvency and labor credits secured by a real estate privilege (*privilégio imobiliário especial*) may rank ahead of secured claims.

In an insolvency, pre-retirement payments would be treated as privileged claims and would rank ahead of common creditors and ahead of secured claims when they are secured by a real estate privilege (*privilégio imobiliário especial*). Although it is not free from doubt and no case law or regulation provides clear guidance, we believe that claims relating to healthcare benefits, pension supplements and suspension payments would be treated as common claims. However, it cannot be precluded that a court would treat such claims as privileged. The guarantee claims of the holders of the New Senior Secured Notes and the holders of such other secured indebtedness against PT Portugal and PT OpCo, as the case may be, will rank ahead of the obligations in respect of pension supplements, healthcare benefits and salaries payable to suspended employees of PT Portugal and PT OpCo, as the case may be, up to the lower of the value of collateral granted by the relevant company and the Aggregate Portuguese Security and Guarantee Limit with respect to PT Portugal and PT OpCo. For a description of the security or the guarantees of the New Senior Secured Notes given by PT Portugal and PT OpCo, see “*General Description of Our Business and the Offering—The Offering—Security*” and “*General Description of Our Business and the Offering—The Offering—Guarantees—New Senior Secured Notes*”. In the event the value of the collateral granted by the relevant company is less than the Aggregate Portuguese Security and Guarantee Limit with respect to PT Portugal, any excess claims against such company up to the Aggregate Portuguese Security and Guarantee Limit will be treated as common claims and will rank behind any privileged claims (including those in respect of post-retirement benefit obligations discussed above). The guarantees to be granted by PT Portugal and PT OpCo for the benefit of the New Senior Notes and the Existing Senior Notes will be unsecured and, therefore, rank as common claims. However, the Aggregate Portuguese Security and Guarantee Limit is an aggregate limit on all guarantees and security recoveries from all of the creditors benefiting from guarantees, and security over the assets, of these companies. Pursuant to the Intercreditor Agreement, the guarantees of the New Senior Notes and the Existing Senior Notes from PT Portugal and PT OpCo will be subordinated to the guarantees of the New Senior Secured Notes and our other senior secured indebtedness from such companies. As a result of the Aggregate Portuguese Security and Guarantee Limit and the provisions of the Intercreditor Agreement, the holders of the New Senior Notes and the Existing Senior Notes may recover materially less, or nothing at all, under the guarantees from PT Portugal and PT OpCo than the holders of the New Senior Secured Notes and our other senior secured indebtedness. The maximum aggregate amount of obligations secured and guaranteed by PT Portugal and PT OpCo under the Aggregate Portuguese Security and Guarantee Limit will be €4,634.4 million and €968.4 million, respectively. As a result, these companies will have no direct obligation to the holders of the New Notes once these limits have been reached, and as a result will be structurally subordinated to all other obligations of such companies, including all required pension supplements, healthcare benefits and salaries payable to pre-retired and suspended employees.

The Pro Forma Financial Information, the Illustrative Aggregated Selected Financial Information and the Historical Consolidated Financial Information presented in these Listing Particulars may not reflect what our actual results of operations and financial condition would have been had we been a combined company for the periods presented and thus these results may not be indicative of our future operating performance. The Illustrative Aggregated Selected Financial Information, the PT Portugal Combined Selected Financial Information and the Pro Forma Financial Information included herein are subject to certain signification assumptions and limitations.

Altice International is a holding company which, since its formation in 2008, has from time to time made significant equity investments in a number of cable and telecommunication businesses in various jurisdictions. The Historical Consolidated Financial Information does not consolidate the results of operations of the entire business undertaking of the Group as it exists at the date of these Listing Particulars for any period for which our historical consolidated financial information has been presented herein. As a result, the Historical Consolidated Financial Information included in these Listing Particulars may not accurately represent the results of operations and financial condition of the entire business undertaking of the Group as it exists as of the date of these Listing Particulars and the comparability of the Historical Consolidated Financial Information over each of the periods presented may be significantly limited. Accordingly, the Historical Consolidated Financial Information may not reflect what our actual results of operations and financial condition would have been had we been a combined company during the periods presented, or what our results of operations and financial condition will be in the future.

In order to aid the comparability of the financial condition and results of operations of the entire business undertaking of the Group as it exists at the date of these Listing Particulars, we have presented the Illustrative Aggregated Selected Financial Information and the Pro Forma Financial Information.

The Illustrative Aggregated Selected Financial Information represents the arithmetical sum of selected financial information extracted from (i) the audited historical consolidated financial statements of Altice International, and (ii) the audited historical financial information of each of the business undertakings the acquisitions of which have been consummated by Altice International prior to December 31, 2013 (to the extent the results of operations of such acquired business undertaking is not included in the audited historical consolidated financial statements of the Group for the relevant period). The Illustrative Aggregated Selected Financial Information is subject to significant limitations. The

Illustrative Aggregated Selected Financial Information does not contain any adjustments to the resulting aggregation other than adjustments to align the accounting framework of the acquired business undertaking in instances where the audited historical financial information of such acquired business undertaking included within such resulting aggregation have been drawn up in accordance with an accounting framework, the measurement and recognition criteria of which differs substantially from the corresponding criteria applicable under IFRS as adopted by the European Union, or where such acquired business undertaking was utilising accounting policy elections that differ substantially from those adopted by Altice International for the purposes of the Historical Consolidated Financial Information. Therefore, among other things, the Illustrative Aggregated Selected Financial Information does not reflect several effects of the relevant acquisitions prior to the dates on which the financial information of the relevant acquired business undertakings were consolidated with the consolidated financial information of Altice International. The Illustrative Aggregated Selected Financial Information neither represents financial information prepared in accordance with IFRS nor pro forma financial information. The Illustrative Aggregated Selected Financial Information is provided with respect to certain limited income statement and cash flow items and accordingly does not include all the information that would usually be included in a statement of income or statement of cash flows or any information that would usually be included in a statement of other comprehensive income, statement of financial position or statement of changes in equity, in each case prepared in accordance with IFRS. The Illustrative Aggregated Selected Financial Information has not been audited in accordance with any generally accepted auditing standards and it has not been reviewed in accordance with any generally accepted review engagement standards. The Illustrative Aggregated Selected Financial Information does not purport to present the operations of the Group as they actually would have been had the relevant acquisitions occurred with effect from any relevant dates indicated or to project the operating results or financial condition of the Group for any future period. The Illustrative Aggregated Selected Financial Information has been prepared only for the years ended December 31, 2011 and 2012 and no similar financial information has been prepared by the Group for any other periods for which Historical Consolidated Financial Statements or Pro Forma Financial Information has been included in these Listing Particulars.

We have also included in these Listing Particulars the Pro Forma Financial Information which gives effect to each of the significant acquisitions Altice International has made since January 1, 2012 (but except as described in these Listing Particulars, without giving effect to the Tricom Acquisition or the Mobius Acquisition).

The Pro Forma Financial Information has not been audited in accordance with any generally accepted auditing standards and it has not been reviewed in accordance with any generally accepted review engagement standards. The Pro Forma Financial Information has been prepared for illustrative purposes only, and because of its nature, the Pro Forma Financial Information addresses a hypothetical situation and, therefore, does not represent the Issuers' actual financial position or results. The Pro Forma Financial Information is based on certain assumptions that we believe are reasonable. Our assumptions may prove to be inaccurate over time. Accordingly, the Pro Forma Financial Information may not reflect what our results of operations and financial condition would have been had we been a combined company during the periods presented, or what our results of operations and financial condition will be in the future.

The Pro Forma Financial Information and the Illustrative Aggregated Selected Financial Information include the results of operations and financial condition of the acquired businesses (and in the case of the Post Transaction Pro Forma Financial Information, the results of ODO and PT Portugal as well) for each of the periods presented even though we may not have owned or controlled such acquired businesses for all or any of the duration of the periods presented and would not have been permitted under IFRS to consolidate the results of such acquired businesses in any historical financial statements. As we have acquired control over ODO and have entered into agreements that will enable us to control PT Portugal, we consolidate 100% of their revenue and expenses in the Post Transaction Pro Forma Financial Information for each of the periods presented, despite the fact that third parties owned significant equity interests therein, as applicable. As we currently have the ability to control Coditel Holding, through which we conduct our operations in Belgium and Luxembourg, we consolidate 100% of its revenues and expenses in the Pro Forma Financial Information and the Illustrative Aggregated Selected Financial Information for each of the periods presented, and in the Historical Consolidated Financial Information from July 1, 2011, despite the fact that third parties own significant interests in the entity. The non controlling interests in the operating results of ODO in the Post-Transaction Pro Forma Financial Information and the non-controlling interests in the operating results of Coditel Holding in the Historical Consolidated Financial Information and Pro Forma Financial Information are reflected in the line item profit or loss attributable to non-controlling interests in the relevant statements of income and financial position. However, since we do not present any Illustrative Aggregated Selected Financial Information below the line item operating income before depreciation, amortization, restructuring costs and other expenses, or EBITDA, the non controlling owners' interests in the operating results of Coditel Holding are not reflected anywhere in the Illustrative Aggregated Selected Financial Information. Such non-controlling interests amounted to negative €1.9 million in the nine months ended September 30, 2014, based on the Pre Transaction Pro Forma Financial Information. The Illustrative Aggregated Selected Financial Information is also subject to the limitations generally attributable to non IFRS measures. For further details regarding the presentation of financial information in these Listing Particulars, including their limitations, please see "*Presentation of Financial and Other Information*".

We have also included in these Listing Particulars the PT Portugal Combined Selected Financial Information which represents the arithmetical sum of selected financial information extracted from (i) the audited historical financial statements of PTC and Meo, S.A. as of and for the years ended December 31, 2012 and 2013; (ii) the unaudited historical condensed financial information of PTC and Meo, S.A. as of and for the nine months ended September 30, 2013 and 2014; and (iii) the unaudited historical condensed financial information of the other subsidiaries in the PT Portugal Group derived from the internal financial reporting systems of the PT Portugal Group. The PT Portugal Combined Selected Financial Information is subject to significant limitations similar to those described above.

In addition, we have presented certain key operating measures across all the countries in which we currently operate even though we may not have owned or controlled such business for the entire duration of the periods presented.

Our lack of operating history as a combined company and the challenge of integrating previously independent businesses make evaluating our business and our future financial prospects difficult. Our potential for future business success and operating profitability must be considered in light of the risks, uncertainties, expenses and difficulties typically encountered by recently organised or combined companies.

We are exposed to local business risks in many different countries.

We conduct our business in multiple jurisdictions, including in Israel, Belgium, the French Overseas Territories, Luxembourg, Portugal and Switzerland. Furthermore, we have completed the Tricom Acquisition and the ODO Acquisition pursuant to which we have expanded our business operations in the Dominican Republic, a jurisdiction where we previously did not have any operations. In addition, we may expand into additional markets in the future by entering into acquisitions or other strategic transactions. Accordingly, our business is subject to risks resulting from differing legal, political, social and economic conditions and regulatory requirements and unforeseeable developments in a variety of jurisdictions, including in emerging markets (which may be more vulnerable to volatility as well as political and economic instability than developed markets). These risks include, among other things:

- differing economic cycles and adverse economic conditions;
- political instability (including expropriation and political violence or disturbance);
- the burden of complying with a wide variety of foreign laws and regulations;
- unexpected changes in the regulatory environment and/or governmental policies;
- varying tax regimes;
- fluctuations in currency exchange, interest rates and inflation (particularly in emerging markets, such as the Dominican Republic, which has historically experienced high rates of inflation);
- inability to collect payments or seek recourse under or comply with ambiguous or vague commercial or other laws;
- varying degrees of concentration among suppliers and customers;
- insufficient protection against violations of our intellectual property rights;
- foreign exchange controls and restrictions on repatriation of funds; and
- difficulties in attracting and retaining qualified management and employees, or further rationalizing our work force;
- significant oil price increases; and
- challenges caused by distance, language and cultural differences.

Our overall success as a business depends to a considerable extent on our ability to anticipate and effectively manage differing legal, political, social and economic conditions and regulatory requirements and unforeseeable developments. We may not continue to succeed in developing and implementing policies and strategies which will be effective in each location where we do business or may do business in the future.

The liquidity and value of our interests in certain of our subsidiaries and our ability to take certain corporate actions may be adversely affected by shareholder agreements and other similar agreements to which we are a party.

Certain of our operations including our operations in Israel, Belgium and Luxembourg are conducted through subsidiaries in which third parties hold a minority equity interest or with respect to which we have provided third parties with rights to acquire minority equity interests in the future. Our equity interests in certain of the subsidiaries, in which third parties hold a minority equity stake, are subject to shareholder agreements partnership agreements and other instruments and agreements that contain provisions that affect the liquidity, and therefore the realizable value, of those interests. We have also entered certain shareholder arrangements with the Outremer Minority Shareholders at the Altice Caribbean level. Most of these agreements subject the transfer of such equity interests to consent rights, pre-emptive rights or rights of first refusal of the other shareholders or partners. Some of our subsidiaries are parties to loan agreements and indentures that restrict changes in ownership of the borrower without the consent of the lenders or noteholders. All of these provisions will restrict the ability to sell those equity interests and may adversely affect the prices at which those interests may be sold. In addition, the present or potential future shareholders in our subsidiaries have the ability to block certain transactions or decisions that we would otherwise undertake. Although the terms of our investments vary, our operations may be affected if disagreements develop with other equity participants in our subsidiaries. Failure to resolve such disputes could have an adverse effect on our business.

Risks Relating to the Integration of Tricom and ODO into Our Business

Anticipated synergies from acquisitions, in particular from the Tricom Acquisition and the ODO Acquisition, may not materialize.

The Tricom Acquisition and the ODO Acquisition completed on March 12, 2014 and April 9, 2014, respectively. We expect to achieve certain synergies relating to the operations of Tricom and ODO as they are one part of the Group. We may not realize any or all of the anticipated synergies of the Tricom Acquisition and the ODO Acquisition that we currently anticipate. Among the synergies that we currently expect are cross selling opportunities to existing customers of Tricom and ODO, network synergies and other operational synergies. The merger application of ODO and Tricom is still pending due to which these entities currently operate as distinct businesses. If such merger approval is not received on a timely basis or at all, or is granted subject to conditions, our operations in the Dominican Republic, including any plans to integrate the operations of Tricom and ODO, may be adversely affected. In addition, until the merger application has been approved, uncertainty remains as to the ability for ODO to utilize Tricom's excess spectrum, which could impact 4G-LTE deployment and therefore increased data demand from our customers. There can be no assurance that we will receive such approval at all or on a timely basis.

We also expect to achieve certain synergies from the 2013 June Transactions. Among the synergies that we currently expect are operational synergies in the French Overseas Territories and Portugal as a result of the Outremer Transaction and ONI Transaction, respectively, increased scale, access to global credit markets, more efficient employment of capital, harmonization of accounting policies and computation of key operating measures and harmonization of best practices across our footprint. Our estimated synergies from the ODO Acquisition, the Tricom Acquisition, the 2013 June Transactions and Mobius Acquisition are subject to a number of assumptions about the timing, execution and costs associated with realizing the synergies. There can be no assurance that such assumptions turn out to be correct and, as a result, the amount of synergies that we will actually realize over time may differ significantly from the ones that we currently estimate and we may incur significant costs in realizing the reorganization of ODO and Tricom. We may not be successful in integrating some or all of these businesses as currently anticipated which may have a material adverse effect on our business and operations.

The integration of Tricom and ODO into the Group could result in operating difficulties and other adverse consequences.

The integration of Tricom and ODO as anticipated into the Group may create unforeseen operating difficulties and expenditures and pose significant management, administrative and financial challenges to our business. These challenges include:

- integration of Tricom and ODO into our current business in a cost effective manner, including network infrastructure, management information and financial control systems, marketing, branding, customer service and product offerings;
- outstanding or unforeseen legal, regulatory, contractual, labor or other issues arising from the Tricom Acquisition and the ODO Acquisition;
- integration of different company and management cultures; and

- retention, hiring and training of key personnel.

In such circumstances, our failure to effectively integrate Tricom and ODO into our Group could have a material adverse effect on our financial condition and results of operations.

Further, ODO has entered into various agreements with suppliers, including a variety of handset device suppliers, outsourcing suppliers and other services suppliers of software licenses, call center support, data management and human resources, consulting, among others, which have terminated following the completion of the ODO Acquisition, as a result of a change in control in ODO's corporate structure. ODO currently sources its handsets and such other services on the basis of temporary arrangements with suppliers, while the Group is negotiating contractual arrangements to replace the agreements that have been terminated. These temporary arrangements which primarily include the sourcing of suppliers on the basis of individual purchase orders may be terminated at any time. Although we are currently working to mitigate such transitional issues, we cannot guarantee that these will be successful.

ODO's ability to operate its business effectively may suffer if we do not, quickly and cost effectively, establish the necessary support functions, as well as a service platform, to support ODO's business following the ODO Acquisition.

Historically, ODO has relied on certain financial, administrative and other resources of Orange S.A. to operate its business and to provide services to its customers. ODO has entered into certain intercompany agreements with Orange S.A. which provided ODO with support services and access to software, IT operations and other technical support. Some of these agreements have automatically terminated upon the ODO Acquisition. As a consequence, ODO will need to create certain independent support systems or contract with third parties to replace Orange S.A.'s systems and services from which ODO will not benefit post closing.

ODO has entered into the Transitional Services Agreement with Orange S.A. identifying, among the products and services provided by Orange S.A. and related entities prior to the ODO Acquisition, which ones will be maintained, modified or terminated and setting forth the conditions under which certain products and services will continue to be provided. The Transitional Services Agreement also have a term of up to twelve months following closing of the ODO Acquisition. These services may not be sufficient to meet ODO's needs, and, after the arrangements with Orange S.A. expire or terminate, we may not be able to replace these services at all or obtain these services at prices or on terms as favorable as currently provided to ODO. Any failure or significant downtime in the services provided to ODO by Orange S.A. during the transition period could impact our results or prevent ODO from paying its suppliers or employees, performing other administrative services on a timely basis or providing an adequate level of service to its customers. Any such event could also have a material adverse impact on our business, financial condition and results of operations.

We may not be successful in establishing a new brand identity for the products and services marketed by ODO.

Historically, ODO has marketed its products and services through the "Orange" brand. Currently, ODO benefits from a Brand License Agreement which allows it to use the "Orange" brand for its current products and services in the Dominican Republic for a period of three to five years after the closing of the ODO Acquisition although this agreement can be terminated early in certain circumstances. The value of the "Orange" brand name has been recognized by ODO's suppliers and customers. We will need to expend significant time, effort and resources to establish a new brand name in the marketplace for ODO's products and services to prepare for the termination of the Brand License Agreement, in addition to our regular marketing and advertising expenses. We cannot guarantee that this effort will ultimately be successful. If our efforts to establish a new brand identity are unsuccessful, our business, financial condition and results of operations could be materially adversely affected. For further details, see "*Description of Our Business—Material Contracts—Agreements with Orange in the Dominican Republic*".

Risks Relating to Legislative and Regulatory Matters

We are subject to significant government regulation and supervision, which could require us to make additional expenditures or limit our revenues and otherwise adversely affect our business, and further regulatory changes could also adversely affect our business.

Our activities as a cable television, broadband Internet infrastructure access provider, ISP, fixed-line and international long distance telephony and mobile operator are subject to regulation and supervision by various regulatory bodies, including local and national authorities in the jurisdictions in which we operate. Such regulation and supervision, as well as future changes in laws or regulations or in their interpretation or enforcement that affect us, our competitors or our industry, strongly influence how we operate our business. Complying with existing and future law and regulations may increase our operational and administrative expenses, restrict our ability or make it more difficult to implement price increases, affect our ability to introduce new services, force us to change our marketing and other business practices, and/or otherwise limit our revenues. In particular, our business could be materially and adversely affected by any changes

in relevant laws or regulations (or in their interpretation) regarding, for example, licensing requirements, access and price regulation, interconnection arrangements or the imposition of universal service obligations, or any change in policy allowing more favorable conditions for other operators or increasing competition. There can be no assurance to you that the provision of our services will not be subject to greater regulation in the future.

In addition to regulation specific to the telecommunications industry, we are from time to time subject to review by competition authorities concerning whether we exhibit significant market power. Regulatory authorities may also require us to grant third parties access to our bandwidth, frequency capacity, facilities or services to distribute their own services or resell our services to end customers.

Furthermore, a failure to comply with the applicable rules and regulations could result in penalties, restrictions on our business or loss of required licenses or other adverse consequences. See “*Regulatory*”.

European Union

The regulations applicable to our operations within the EU often derive from EU Directives. The various Directives require EU Member States to harmonize their laws on communications and cover such issues as access, user rights, privacy and competition. These Directives are reviewed by the EU from time to time and any changes to them could lead to substantial changes in the way in which our businesses in the relevant jurisdictions are regulated and to which we would have to adapt. Any changes to these EU Directives could lead to substantial changes in the way in which our businesses in the European Union are regulated.

Belgium and Luxembourg. In Belgium and Luxembourg, telecommunication activities are subject to significant regulation and supervision by various regulatory bodies. In addition, specific requirements can also be imposed in Belgium and Luxembourg on entities that are deemed, by the Belgium Institute for Postal Services (the “BIPT”) or the Luxembourg Regulatory Institute (the “LRI”) and/or radio and television regulatory authorities, to have a significant power in relevant markets that are not sufficiently competitive, including grant of access, non-discrimination and transparency obligations.

In Belgium and Luxembourg, we are subject to, among other things:

- price regulation for certain services that we provide in Belgium (for instance, the Belgian Ministry for Economic Affairs must consent to any increase in the prices that we charge our subscribers for providing basic cable television);
- rules governing the interconnection between different networks and the interconnection rates that we can charge and that we pay;
- rules and remedies imposed on electronic communications services providers with “significant market power” as defined in Directive 2002/21/EC of the European Parliament (as amended and updated from time to time) and of the Council of 7 March 2002 on a common regulatory framework for electronic communications networks and services;
- risk of regulatory authorities granting third parties access to our network;
- requirements that, under specified circumstances, a service distributor must carry certain broadcasts or obtain consent to carry other broadcasts;
- rules for authorizations, licensing, acquisitions, renewals and transfers of licenses;
- rules and regulations relating to subscriber privacy;
- requirements that we provide or contribute to the provision of certain universal services, including requirements to provide certain “social” tariffs;
- taxes imposed on our public rights of way; and
- other requirements covering a variety of operational areas such as land use and environmental protection, moving the cables in our network underground, equal employment opportunity, technical standards, subscriber service requirements and the implementation of data retention obligations in Belgium.

For an overview of the regulatory landscape in Belgium and Luxembourg, see “*Regulatory—Belgium and Luxembourg*”.

Portugal. In Portugal, our activities in the electronic communication industry, including cable television, broadband Internet and telephony industries, are subject to significant regulation and supervision by ANACOM.

In Portugal, we are subject to, among other things:

- rules regarding authorizations, information duties and specific rights of use for number assignments;
- price regulation with respect to fixed call termination charges;
- number portability obligations;
- rules regarding the interconnection of our network with those of other network operators (capacity interconnection);
- requirements that a network operator carry certain channels (the must carry obligation);
- rules and regulations relating to subscriber privacy;
- regulations governing the limitation of exit-fees or cancellation charges;
- default barring of value-added services;
- rules and regulations imposing co-installation and co-location obligations with regard to our network (including our submarine cable landing stations), the scope of which can be subject to interpretation;
- obligation to contribute to the universal service fund; and
- sector specific charges (e.g. annual charge and investment obligations created by Law 55/2012 of Portugal).

For an overview of the regulatory landscape in Portugal, see “*Regulatory—Portugal*”.

Israel

In Israel, we are subject to, among other things:

- price regulation for certain services that we provide, specifically analog television;
- rules governing the interconnection between different telephone networks and the interconnection rates that we can charge and that we pay;
- regulations requiring us to maintain structural separation between our cable television, broadband Internet infrastructure access and fixed-line telephony, ISP and mobile subsidiaries;
- regulations governing the prohibition of exit-fees or cancellation charges;
- regulations requiring us to grant third party ISPs access to our cable network;
- regulations restricting the number of channels we can own and specifying the minimum investment we are required to make in local content productions;
- regulations governing roaming charges and other billing and customer service matters;
- requirements that, under specified circumstances, a cable system carry certain television stations or obtain consent to carry certain television stations according to telecommunication laws;
- rules for authorizations, licensing, acquisitions, renewals and transfers of licenses;
- requirements that we extend our cable television, broadband Internet infrastructure access and fixed-line telephony services to areas of Israel even where it is not economically profitable to do so;
- rules and regulations relating to subscriber privacy;
- laws requiring levels of responsiveness to customer service calls;

- antitrust law and regulations and specific terms within the antitrust authority's approval for the Israeli cable consolidation;
- requirements that we provide or contribute to the provision of certain universal services; and
- other requirements covering a variety of operational areas such as land use, health and safety and environmental protection, moving the cables in our network underground, equal employment opportunity, technical standards and subscriber service requirements.

The Israeli Ministry of Communications has recently taken active steps to increase competition in the fixed-line and mobile telecommunications industries, including providing licenses to MVNOs and eliminating termination fees that operators can charge, except in limited circumstances, and prohibiting the linkage of the price and terms of handsets to the services or benefits of the mobile contract. The Israeli Ministry of Communications has also introduced a policy for the establishment of a wholesale market for broadband Internet infrastructure access pursuant to which certain limitations on structural separation and bundling of products may be reduced, but we would also be required to provide access to our network infrastructure to other service providers on a wholesale basis. The price for such access would be determined based on a commercial agreement between us and any such service provider, but the Israeli Minister of Communications will be entitled to intervene in the determination of the terms or the price that have been agreed or that is demanded by us if it should find that such price is either unreasonable or could harm the competition, or if we have been unable to enter into a commercial agreement with the service provider. Further, the Israeli Ministry of Communications has issued regulatory instructions, including the method of setting wholesale service rates and, in the case of Bezeq, the maximum rates that can be collected by Bezeq from other license holders who make use of its infrastructure for the years 2014 to 2018, in an attempt to create a wholesale market for broadband Internet infrastructure access and fixed line telephony services which would allow service providers (such as ISPs, VOB providers and IPTV providers) to provide services to their customers by using our cable network. Should the wholesale market develop, certain requirements for structural separation and bundling of products that apply to Bezeq and us may be lifted, and thus competition in the broadband Internet infrastructure access market may increase significantly which could negatively affect or results of operations.

Due to concerns over "margin squeeze" practices by HOT and Bezeq, the Ministry of Communications has proposed to review every new retail offer made by HOT and Bezeq to new or existing subscribers. Under the proposal, the Ministry may notify an infrastructure owner, if there is a concern over margin squeeze, that it is forbidden to offer the proposed package. HOT is currently studying the terms of the proposal and, at this time, is unable to evaluate the effect the proposal would have on its ability to compete if approved.

For an overview of the regulatory landscape in Israel, see "*Regulatory—Israel*".

French Overseas Territories. In the French Overseas Territories, our existing and planned activities in the cable television, broadband Internet and telephony industries are subject to significant regulation and supervision by various regulatory bodies, including national and EU authorities.

Regulation of our service includes price controls (for termination charges), service quality standards, requirements to carry specified programming, requirements to grant network access to competitors and content providers, and programming content restrictions. In particular, we are subject, for our activities in the French Overseas Territories to:

- rules regarding declarations and registrations with telecommunication regulatory authorities;
- individual requirements associated with commitments made in the context of authorizations granted by telecommunication regulatory authorities for the use of frequencies;
- price regulation with respect to call termination charges;
- rules regarding the interconnection of our network with those of other network operators;
- requirements that a network operator carry certain channels (the must carry obligation);
- rules relating to the quality of the landline networks;
- specific rules relating to the access to new-generation optical fiber networks;
- rules relating to the content of electronic communications, antitrust regulations; and
- specific tax regimes;

- taxes imposed on our public rights of way;
- other taxes imposed on our operations including a 0.9% tax levied on electronic communication services related revenues (excluding VAT) in excess of €5,000,000 (subject to certain deductions and exclusions, and with specific rebate for bundled offers) of all telecommunication operators, which was introduced by the Public Audiovisual Reform law of March 5, 2009 (*loi relative à la communication audiovisuelle et au nouveau service public de la télévision*); and
- other requirements covering a variety of operational areas such as land use and environmental protection, moving the cables in our network underground, equal employment opportunity, technical standards, subscriber service requirements and the implementation of data retention obligations in France.

In addition, the expiry of one of Le Cable Guadeloupe’s 28 cable network agreements (that of Pointe-à-Pitre) was due on November 22, 2014. On October 1, 2014, the Guadeloupe Town Hall approved the assignment of its cable network to WSG (“World Services Guadeloupe”, a 100% owned subsidiary of Altice Blue Two) for €400,000.

Further, the payment activity we conduct in the French Overseas Territories through our subsidiary OPS SAS, is subject to the control of the French *Autorité de Contrôle Prudentiel* (“ACP”). In connection with this activity, OPS SAS is subject to the control of the ACP covering matters such as, for instance, its level of equity capital, its management standards and the protection of the funds it receives. For an overview of the regulatory landscape in the French Overseas Territories, see “*Regulatory—French Overseas Territories*”.

Dominican Republic. As a result of the completion the Tricom Acquisition and the ODO Acquisition, we are and will continue to also be subject to significant regulations in the Dominican Republic. For a description of the regulatory landscape in the Dominican Republic, see “*Regulatory—Dominican Republic*”.

The European Commission’s review of roaming charges may continue to lead to a reduction in revenues from mobile services

The European Commission, or EC, regulates the roaming charges that may be charged in the wholesale market and the retail market in Europe. These regulations extend to data and Short Messaging Services, or SMS, or text messaging. On July 1, 2012, the previous roaming regulations were replaced by a new version, known as “*Roaming III*” which will expire on June 30, 2022. In addition to setting maximum voice roaming rates (subject to a glide path) that may be charged with respect to the wholesale and retail market, for voice, data and SMS services, Roaming III also features (1) extended transparency and consumer-protection measures (“bill-shock”) that go beyond the EU territory, (2) the introduction of an obligation for mobile operators in the wholesale market to provide reasonable network access in order to allow roaming services and (3) the decoupling of roaming services from other services, while enabling a consumer to use the same number.

The Roaming III regulations have had, and are expected to continue to have an adverse effect on the revenues of our mobile businesses in the European Union (including PT Portugal upon the consummation of the PT Portugal Acquisition) and on our results of operations. In addition, the EC’s proposed “*Connected Continent*” legislation, which is described in the next risk factor, could lead to the elimination of roaming charges for calls within the EU, which would similarly have an adverse effect on us.

The European Commission’s proposed “Connected Continent” legislation could adversely affect our businesses in the European Union

The EC is finalizing its plans to pass a legislative package implementing a single telecommunications market—the so-called “*Connected Continent*” legislation—in order to stimulate the provision of cross-border European services. The draft legislation, in its initial wording, addresses matters such as a single European authorization and convergence of regulatory remedies, a standard EU wholesale broadband access product, the harmonization of spectrum authorization procedures, net neutrality and transparency, international mobile roaming and international calls, and consumer protection.

In its latest form, the legislative package approved by the European Parliament on April 3, 2014 provides, among other things, for (1) the cancellation of retail market roaming tariffs by December 15, 2015, which would result in operators no longer being able to differentiate between retail domestic and roaming communications within EU mobile networks, (2) clear rules for traffic management and the obligation of operators to assure a certain quality of service and (3) reinforced consumer rights.

In December 2014, the Body of European Regulators for Electronic Communications approved the working documents in view of a workshop to be held in February 2015. On January 8, 2015, the European Council issued its Draft Council

Conclusions on Single Market Policy which calls for the information of competitiveness tests by the end of 2015. The Connected Continent regulation, as part of the Single Digital Market, is included in the Commission's Work Programme for 2015, no precise legislative planning has been released yet. The legislation is not expected to be adapted to its final version before the end of 2015.

If approved, this legislation is expected to have an adverse effect on our businesses in the European Union due to anticipated price decreases, higher operational costs and increased competition.

Burdensome regulation in an open market may put PT Portugal at a disadvantage to its competitors and could adversely affect its business

The Portuguese electronic communications sector is fully open to competition. However, many regulatory restrictions and obligations are still imposed on PT Portugal. Pursuant to the European Relevant Markets Recommendation issued in 2007 (the "2007 Recommendation"), which significantly reduced the number of markets subject to regulation, ANACOM is re-analyzing the retail and wholesale markets to identify which markets are still relevant for regulatory intervention and which electronic communications operators and service providers, if any, it considers to have significant market power in those markets. Additionally, ANACOM is determining the regulatory remedies that should be imposed on those operators and service providers. ANACOM has not indicated when it will conclude this round of market analysis, but it is expected to be concluded by the end of 2015. On October 9, 2014, the European Commission adopted a new European Relevant Markets Recommendation that replaces the 2007 Recommendation and further reduced the number of relevant markets subject to *ex ante* regulation.

ANACOM has re-analyzed some of the markets defined under the European Relevant Market Recommendation and issued findings that PT Portugal had significant market power in certain markets, including the wholesale market for call termination on individual public telephone networks provided at a fixed location, the market for call termination on individual mobile networks, the market for the provision of wholesale (physical) network infrastructure access and the wholesale leased lines terminating segments market. In December 2013, ANACOM launched a public consultation on a draft decision regarding the reanalysis of the retail markets for fixed access and telephony services and of the wholesale market of call origination at a fixed location. ANACOM is proposing to withdraw the existing retail regulation on those markets while keeping the wholesale call origination market fully regulated.

In certain cases, such as the wholesale broadband access market and the wholesale leased lines trunk segments market, ANACOM has segmented the markets into "C" (competitive) and "NC" (non-competitive) segments and issued a finding that PT Portugal had significant market power in the non-competitive segments. ANACOM has the power to impose remedies to increase competition in those markets. However, ANACOM has not completed the review of all the markets identified by the European Relevant Market Recommendation, and we expect that ANACOM will reduce the adverse impacts of the remedies imposed on PT Portugal. However, additional reviews by ANACOM could include other markets, such as access to next generation networks. For example, on February 6, 2012, ANACOM approved a draft decision concerning the review markets for wholesale physical network infrastructure access at a fixed location, or Market 4, and markets for wholesale broadband access, or Market 5. Pursuant to this draft decision, ANACOM proposed to include high-speed broadband networks (e.g. FTTH networks) in order to require operators with Significant Market Power, or SMP, to provide access to these networks. In this connection, pursuant to this draft decision, ANACOM intends to maintain its previous finding (in 2008) that PT Portugal is an SMP operator in the national wholesale market for access to network infrastructure at a fixed location and in the broadband access wholesale market in non-competitive areas.

With respect to Market 4, in addition to the obligation of granting unbundled access to copper loops, subloops, ducts and poles at the national level, in its draft decision of February 6, 2012, ANACOM proposed to impose on PT Portugal a geographically differentiated obligation to provide its wholesale customers with virtual access to optical fiber (advanced bitstream). The analysis review procedure was not concluded, mainly due to the changes that took place in the domestic market during 2013 and 2014 (merger between ZON and Optimus and investments initiated by Vodafone, for expansion of its fiber networks and the infrastructure sharing agreement entered into between PT Portugal and Vodafone) and the publication, in September 2013, of the EC's recommendation on NGA non-discrimination and costing methodologies. In light of these developments, a new ANACOM consultation on Markets 4 and 5 is expected in the future.

With respect to the wholesale leased line markets, in which PTC was declared an operator with Significant Market Power, ANACOM decided to make ethernet circuits subject to a retail-minus rule and approved a final decision amending PTC's leased lines reference offer (*oferta de referência de circuitos alugados*), or "ORCA" and ethernet accesses reference offer (*oferta de referência de circuitos Ethernet*), or "ORCE" in 2012. At the same time, ANACOM extended PTC's co-installation obligations under its regulated reference offers to its submarine cable landing stations.

We receive correspondence from ANACOM from time to time regarding compliance with such and other regulations. If we are found to be in breach of such regulations, the regulators may impose penalties, fines or additional obligations on

us to rectify such breaches which may have an adverse effect on our business operations. Remedies imposed by ANACOM may also require PT Portugal to provide services in certain markets or geographic regions or to make investments that it would otherwise not choose to make. In addition, PT Portugal incurred and may still have to incur, expenses to adapt its operations to changing regulatory requirements and to ensure regulatory compliance. The resources PT Portugal may be required to fulfill our regulatory obligations in Portugal could adversely affect its ability to compete.

PT Portugal's obligations as a universal service provider in Portugal could adversely affect its results of operations and profitability

On October 12, 2012, following ANACOM's decision on the designation of a universal service provider, the Portuguese Ministries of Finance, Economy and Employment launched a public tender to designate the universal service providers, which included a compensation fund for universal service providers. PTC submitted bids for certain tenders. On October 18, 2013 the Portuguese government determined the designation of Optimus and ZON as the universal service providers for the connection to a public electronic communications network at a fixed location and the provision of publicly available telephone services, and of PTC as the universal service provider for publicly available telephone (payphones). In addition, on July 29, 2013, the Portuguese government decided to initiate a direct award procedure in respect of the provision of comprehensive directory and directory inquiry services for a period of 12 months, with the possibility of such period being extended for an additional six months. PTC was the only company that presented a proposal and was awarded the contract to provide directories and directory inquiry services.

As the universal service provider for payphones, directories and directory inquiry services, PTC is required to make available those services in accordance with Portuguese regulations whether or not they are profitable to us. In addition, PTC will be required to contribute to the compensation fund for universal services providers according to its share of the revenues of the national telecommunications sector. These obligations could adversely affect the expenses and PTC's profitability.

We can only operate our business for as long as we have licenses from the relevant authorities in the jurisdictions in which we operate.

We are required to hold licenses to own and operate our networks and to broadcast our signal to our customers. These licenses generally require that we comply with applicable laws and regulations, meet certain solvency requirements and maintain minimum levels of service.

In Israel, we conduct our operations pursuant to licenses granted to us by the Israeli Ministry of Communications and by the Council for Cable and Satellite Broadcasting for specified periods, which may be extended for additional periods upon our request to the Israeli Ministry of Communications and confirmation that we have met certain performance requirements. Our broadcast license is valid until 2017, our domestic operator license for fixed-line telephony and broadband Internet infrastructure access is valid until 2023, our UMTS-based mobile license is valid until 2031 and our general international telecommunications service provider license is valid until 2032. There is no certainty, however, that the licenses will be renewed or extended in the future or that they will not be cancelled or changed by the Israeli Ministry of Communications. Any cancellation or change in the terms of our licenses may materially affect our business and results of operations. Furthermore, although we believe that we are currently in compliance with all material requirements of our licenses, the interpretation and application of the technical standards used to measure these requirements, including the requirements regarding population coverage and minimum quality standards and other license provisions, disagreements have arisen and may arise in the future between the Israeli Ministry of Communications and us. We have provided significant bank guarantees to the Israeli Ministry of Communications to guarantee our performance under our licenses. If we are found to be in material breach of our licenses, the guarantees may be forfeited and our licenses may be revoked. In addition, the Israeli Ministry of Communications is authorized to levy significant fines on us for breaches of our licenses.

PT Portugal provides a significant number of services in Portugal under licenses and authorizations granted by ANACOM to its subsidiaries PTC and Meo, S.A. Certain licenses require PT Portugal and/or its subsidiaries to comply with future regulatory changes, subject to the principle of proportionality, even where PT Portugal and its subsidiaries may not be entitled to receive compensation for the costs of implementing such changes. In addition, PT Portugal and/or its subsidiaries may need to apply for the renewal of certain licenses in the near future. ANACOM can terminate Meo, S.A.'s mobile licenses in the event of non-payment of legally due fees for a period of two consecutive years or in situations of severe and persistent non-compliance with the terms and conditions of its licenses. Through Meo, S.A., PT Portugal holds renewable licenses to provide Global System for Mobile Communications, or GSM, or 2G, and 3G mobile telephone services throughout Portugal, valid until 2016 and 2022, respectively. In January 2012, Meo, S.A. was allocated the right to use frequencies to provide, among other technologies, 4G mobile telephone services throughout Portugal, and in March 2012, ANACOM issued a renewable license to Meo, S.A., valid until 2027, with respect to the use of these frequencies. This license also unifies the previous 2G and 3G licenses issued to Meo, S.A. If ANACOM were to terminate such licenses for any reason, PT Portugal would not be able to conduct the activities authorized by

those licenses. This loss would eliminate an important source of our revenues. ANACOM has recently issued certain decisions with respect to PT Portugal's DTT license, pertaining to required DTT coverage and implementation of additional multi-frequency channels to function in overlay with its single frequency network in order to comply with the license. PT Portugal has responded to these decisions and the matter is still pending a final decision from ANACOM.

In the Dominican Republic, ODO was awarded a concession to and are licensed to provide telecommunications services. ODO's concession was originally granted under a concession agreement with Indotel in 1996 and will expire on August 1, 2015. In order to renew ODO's concession, a renewal request needs to be submitted to Indotel by August 1, 2014. In the event that the concession agreement expires and ODO has not submitted a request to renew, according to applicable law, Indotel may automatically renew the agreement for another 20 year term or terminate the agreement. If ODO correctly files all of the documentation for renewal and remains in compliance with all of Indotel's policies and regulations, Indotel should approve the renewal request, however we cannot guarantee approval. ODO has not yet filed an application for renewal price it is awaiting Indotel providing a template Concession Agreement. In addition, ODO currently holds a number of frequency license certificates issued by Indotel. All of ODO's frequency licenses are valid until August 1, 2015. We cannot guarantee that Indotel will approve ODO's renewal request for its concession or for its frequency licenses. Furthermore, certain regulatory approvals, such as new build permits, may be required for ODO to operate antenna sites with other frequencies/frequency bands, in particular where the shift is made from a higher frequency band (e.g. 1800 MHz) to a lower frequency band (e.g. 900 MHz). To the extent that ODO seeks to operate antenna sites with other frequencies/frequency bands in the future, failure to obtain such regulatory approvals could have a negative impact on the coverage of its network. If Indotel does not renew ODO's concession or frequency licenses or if ODO fails to obtain any regulatory approvals that are required, our business, financial condition and results of operations following the ODO Acquisition could be materially adversely affected.

Should we fail to comply with these requirements or the requirements of any of our other licenses, we may be subject to financial penalties from the relevant authorities and there may also be a risk that licenses could be partially or totally withdrawn. The imposition of fines and/or the withdrawal or non-renewal of licenses could have a material adverse effect on our results of operations and financial condition and prevent us from conducting our business.

ODO's activities may be affected by Indotel's decisions regarding the granting, amendment or renewal of frequency licenses.

ODO's activities as a mobile network operator in the Dominican Republic are subject to regulation and supervision by various Dominican Republic authorities, in particular the Dominican Institute for Telecommunications ("Indotel"). Since 2002, Indotel has issued a series of decrees and resolutions in order to implement the National Frequency Allocation Plan ("PNAF"), the objective of which is to reorganize the radio spectrum in the Dominican Republic and make more bands available for operators to provide mobile services. Frequency migration is currently in progress and concerns ODO among other operators. For example, ODO must migrate from its current 1800Mhz frequency to another frequency to be allocated to it in the 2110-2155Mhz band in order to comply with PNAF provisions, which pair the 1700Mhz frequency with the 2100Mhz frequency. Spectrum entitlement rights relating to the migrated bands remain in dispute among various telecom operators. In addition, Indotel has not confirmed the final step in a frequency swap assigning the 1720-1730 MHZ and the 2120-2130 MHz ranges to ODO in exchange for other frequencies.

We do not have complete control over the programming that we provide or over some of the prices that we charge, which exposes us to third party risks and may adversely affect our business and results of operations.

In all of our jurisdictions where we provide pay television services, we are required to carry certain broadcast and other channels on our cable system that we would not necessarily carry voluntarily. For example, in Israel, these "must carry" obligations apply to: (i) two specific governmental channels; (ii) two specific commercial channels; (iii) the "Knesset" channel, which is a channel broadcasting content from the Israeli parliament; (iv) one educational channel and (v) channels from a special license broadcaster that we deliver to all of our pay television subscribers. See "*Regulatory—Israel—Television—Access to DTT Channels*". We cannot guarantee that the remuneration, if any, that we receive for providing these required channels will cover our actual costs of broadcasting these channels, or provide the return that we would otherwise receive if we were allowed to freely choose the programming we offer on our system.

We may incur significant costs to comply with city planning laws.

We are subject to planning laws when we upgrade or expand our networks. In particular, our current installation of the UMTS network in Israel is subject to compliance with the National Zoning Plan 36 (TAMA 36) and the directives issued thereunder, which are aimed at reducing the danger of radiation and the damage to the environment. The cost of complying with TAMA 36 can be substantial and there is currently a regulatory process underway to amend TAMA 36 which would place substantial limitations and further increase the cost of erecting our UMTS network. See "*Regulatory—Israel—Mobile—Construction of Network Sites—National Zoning Plan 36A*". In addition, the local loop of our networks is generally located aboveground. Local municipal governments generally have the authority to require us

to move these network lines underground. Usually, we are able to coordinate with other utility suppliers to share the costs associated with moving lines underground but no assurance can be given that we will always be able to do so. Nevertheless, the costs of complying with municipal orders can be substantial and not subsidized by such municipal government, and may require us to incur significant costs in the future.

We have had difficulties obtaining some of the building and environmental permits required for the erection and operation of our mobile network sites in Israel, and some building permits have not been applied for or may not be fully complied with. These difficulties could have an adverse effect on the coverage, quality and capacity of our mobile network. Operating mobile network sites without building or other required permits, or in a manner that deviates from the applicable permit, may result in criminal or civil liability to us or to our officers and directors.

Our ability to maintain and improve the extent, quality and capacity of our mobile network coverage in Israel depends in part on our ability to obtain appropriate sites and approvals to install our mobile network infrastructure, including mobile network sites. The erection and operation of most of these mobile network sites require building permits from local or regional planning and building authorities, as well as a number of additional permits from other governmental and regulatory authorities. In addition, as part of our UMTS network build-out, we are erecting additional mobile network sites and making modifications to our existing mobile network sites for which we may be required to obtain new consents and approvals.

For the reasons described in further detail below, we have had difficulties obtaining some of the building permits required for the erection and operation of our mobile network sites.

Mobile network site operation without required permits or that deviates from the permit has in some cases resulted in the filing of criminal charges and civil proceedings against our subsidiaries in Israel and its officers and directors, and monetary penalties against such subsidiaries, as well as demolition orders. In the future, we may face additional monetary penalties, criminal charges and demolition orders. The prosecutor's office has set up a national unit to enforce planning and building laws. The unit has stiffened the punishments regarding violations of planning and building laws, particularly against commercial companies and its directors. If we continue to experience difficulties in obtaining approvals for the erection and operation of mobile network sites and other mobile network infrastructure, this could have an adverse effect on the extent, coverage and capacity of our mobile network, thus impacting the quality of our voice and data services, and on our ability to continue to market our products and services effectively. In addition, as we seek to improve the range and quality of our mobile telephony services, we need to further expand our mobile network, and difficulties in obtaining required permits may delay, increase the costs or prevent us from achieving these goals in full. Our inability to resolve these issues in a timely manner could also prevent us from achieving or maintaining the mobile network coverage and quality requirements contained in our license.

Since June 2002, following the approval of the National Building Plan 36 (the "Plan"), which regulates network site construction and operation, building permits for our mobile network sites (where required) have been issued in reliance on the Plan.

We have set up several hundred small communications devices, called wireless access devices, pursuant to a provision in the Planning and Construction Law, which exempts such devices from the need to obtain a building permit. A claim was raised that the exemption does not apply to mobile communications devices and the matter reached first instance courts a number of times, resulting in conflicting decisions. This claim is included in an application to certify a class action filed against certain Israeli mobile telephone operators, but we were not included in this claim. In May 2008, a district court ruling adopted the position that the exemption does not apply to wireless access devices. The mobile telephone operators filed a request to appeal this ruling to the Supreme Court. In May 2008, the Israeli Attorney General filed an opinion regarding this matter stating that the exemption applies to wireless radio access devices under certain conditions. Subsequently, two petitions were filed with the High Court of Justice in opposition to the Israeli Attorney General's opinion. The matter is still pending before the Supreme Court and the High Court of Justice.

In September 2010, adopting the position of the Israeli Attorney General, the Israeli Supreme Court issued an interim order prohibiting further construction of radio access devices for mobile networks in reliance on the exemption mentioned above. In September 2011, the Supreme Court permitted HOT Mobile and Golan Telecom to use the exemption in order to erect their new UMTS networks until December 31, 2013, provided, however, that no more than 40% of the facilities that the operator erects are within the jurisdiction of any municipality, an affidavit is submitted in advance to the municipality's engineer and the safety zone does not exceed four meters and does not deviate from the boundaries of the lot. On August 28, 2013 we submitted a formal request with the Israeli Supreme Court, requesting a renewal of the exemption. On September 30, 2013, we received a response from the Supreme Court stating that they had requested a formal reply from the state on this subject matter. On October 1, 2013, the Israeli Supreme Court passed a decree nisi in relation to the petition to which the State filed a response on December 17, 2013, requesting a perpetual injunction to prevent the erecting of access network devices until legislation was put in place by the Israeli Ministry of Interior and the Ministry of Communication to regulate this matter. In its response, the State further claimed that the

exemption relating the erecting of access network devices for HOT Mobile and Golan should only be valid until June 30, 2014. The Supreme Court has not passed judgment on this however and until a final decision has been passed by the Supreme Court however, HOT Mobile will be allowed to continue the deployment of its UMTS network.

If a definitive court judgment holds that the exemption does not apply to mobile devices at all, or in case of disagreements with the municipalities where we have installed our devices or a regulatory authority regarding the interpretation of the Supreme Court's decision, we may be required to remove the existing devices and would not be able to install new devices on the basis of the exemption. As a result, our mobile network capacity and coverage would be negatively impacted, which could have an adverse effect on our revenue and results of operations.

We, like the other mobile telephone operators in Israel, provide repeaters, also known as bi-directional amplifiers, to subscribers seeking an interim solution to weak signal reception within specific indoor locations. In light of the lack of a clear policy of the local planning and building authorities, and in light of the practice of the other mobile telephone operators, we have not requested permits under the Planning and Building Law for the repeaters. However, we have received an approval to connect the repeaters to our communications network from the Israeli Ministry of Communications and have received from the Israeli Ministry of Environmental Protection permit types for all our repeaters. If the local planning and building authorities determine that permits under the Planning and Building Law are also necessary for the installation of these devices, or any other receptors that we believe do not require a building permit, it could have a negative impact on our ability to obtain permits for our repeaters.

The Israeli Ministry of Environmental Protection notified us of a new condition for all of our 3G mobile network site operation permits, according to which we must install systems software (provided by the Israeli Ministry of Environmental Protection) that continuously monitors and reports the level of power created in real time from the operation of our 3G mobile network sites (the "Monitoring System"). Since May 2012, we started erecting our new UMTS cell sites according to construction permits received in November 2011. We have also made practical examinations to all our new UMTS cell sites. All of the examinations showed that our new UMTS cell sites comply with the safety standard determined by the Israeli Ministry of Environmental Protection. As of August 2012, we began to apply requests for operation permits to our sites to the Commissioner. We also applied to the Commissioner for extended time to connect to the monitoring system. As of November 2012, we started receiving operation permits, which are subject to the demand to connect to the monitoring system no later than February 5, 2013. On February 4, 2013, we were notified by the Israeli Ministry of Environmental Protection that we have complied with all of its requirements for connecting to the monitoring system.

We are of the opinion that all of the antennas that we operate comply with the conditions of the safety permits that we were granted by the Israeli Ministry of Environmental Protection. However, implementation of the monitoring software increases our exposure and our directors and senior officers to civil and criminal proceedings in the event that any antennas are found to not meet the conditions of the permits granted to us and the maximum permitted power. In addition, if our antennas are found to not meet the conditions of the permits granted to us and the maximum permitted power, the Israeli Ministry of Environmental Protection may revoke existing permits, which would require us to dismantle existing mobile network sites. As a result, our network capacity and coverage would be negatively impacted, which could have an adverse effect on our revenue and results of operations.

We may be required to indemnify certain local planning and building committees in Israel with respect to claims against them.

In Israel, under the Planning and Building Law, 1965, local planning committees may be held liable for the depreciation of the value of nearby properties as a result of approving a building plan. Under the Non-Ionizing Radiation Law, 2006, the National Council for Planning and Building requires indemnification undertakings from mobile companies as a precondition for obtaining a building permit for new or existing mobile network sites. The National Council has decided that until the Plan is amended to reflect a different indemnification amount, mobile companies will be required to undertake to indemnify the committees in full against all losses resulting from claims against a committee for reductions in property values as a result of granting a permit to the mobile network site. On June 1, 2010, the National Council for Planning and Building approved the National Building Plan No. 36/A/1 version that incorporates all of the amendments to the Plan (the "Amended Plan"). The Amended Plan is subject to government approval in accordance with the Planning and Building Law.

As of September 30, 2014, we had approximately 342 indemnification letters outstanding to local planning and building committees although no claims have been filed against us under such letters. Calls upon our indemnification letters may have a material adverse effect on our financial condition and results of operations.

In addition, the requirement to provide indemnification in connection with new building permits may impede our ability to obtain building permits for existing mobile network sites or to expand our mobile network with the erection of new mobile network sites. The indemnification requirement may also cause us to change the location of our mobile network

sites to less suitable locations or to dismantle existing mobile network sites, which may have an adverse effect on the quality and capacity of our mobile network coverage.

In 2007, the Israeli Ministry of Interior Affairs extended the limitation period within which depreciation claims may be brought under the Planning and Building Law from three years from approval of the building plan to the later of one year from receiving a building permit for a mobile network site under the Plan and six months from the construction of a mobile network site. The Israeli Ministry retains the general authority to extend such period further. This extension of the limitation period increases our potential exposure to depreciation claims.

Adverse decisions of tax authorities or changes in tax treaties, laws, rules or interpretations could have a material adverse effect on our results of operations and cash flow.

The tax laws and regulations in the jurisdictions in which we operate may be subject to change and there may be changes in the content as well as in the interpretation and enforcement of tax law. As a result, we may face increases in taxes payable if tax rates increase, or if tax laws and regulations are modified by the competent authorities in an adverse manner.

In addition, the tax authorities in the jurisdictions in which we operate periodically examine our activities. We regularly assess the likelihood of such outcomes and have established tax allowances which represent management's best estimate of the potential assessments.

The resolution of any future tax matters could differ from the amount reserved, which could have a material adverse effect on our cash flows, business, financial condition and results of operations for any affected reporting period.

Portugal Telecom SGPS, S.A. the former parent of the PT Portugal Group, is subject to an ongoing investigation by the Central Department of Penal Investigation and Action relating to purchase of commercial paper issued by Rio Forte Investments S.A.

There is an ongoing investigation by the Central Department of Penal Investigation and Action ("*Departamento Central de Investigação e Ação Penal*") involving Portugal Telecom SGPS, S.A. related to the purchase by PT International Finance BV and PT Portugal (subsidiaries of Portugal Telecom SGPS, S.A. at the date of the purchase) of certain commercial paper issued by Rio Forte Investments S.A. (the "Rio Forte Investigation"). In connection with this process, on January 6, 2015, investigators searched the Lisbon offices of Portugal Telecom SGPS, S.A. The Rio Forte Investigation concerns, among other things, suspicion of aggravated fraud ("*burla qualificada*"). Based on public statements by Portugal Telecom SGPS, S.A., they intend to cooperate fully with the authorities. As we did not control PT Portugal during the period to which the Rio Forte Investigation relates and do not control PT Portugal as of the date of these Listing Particulars, we have very limited information with respect to the facts and circumstances surrounding the subject matter of the Rio Forte Investigation. In addition, because the Rio Forte Investigation is non-public, we do not know who is being investigated or if any PT Portugal employees are the subject of the Rio Forte Investigation. Oi S.A. has warranted in the PT Portugal Acquisition Agreement that, upon closing of the PT Portugal Acquisition, neither PT Portugal nor any other member of the PT Portugal Group would be bound by any ongoing obligation towards Portugal Telecom SGPS, S.A. in connection with the commercial paper of Rio Forte Investments S.A. In addition, the PT Portugal Acquisition Agreement contains certain undertakings regarding indemnity of PT Portugal by Oi S.A. for certain adverse consequences which may have been or may be incurred by PT Portugal as a result of the purchase, holding or transfer of the Rio Forte Investments S.A. commercial paper. However, until the Completion Date we will not control PT Portugal and as a result have no involvement with the Rio Forte Investigation, nor do we have any influence over PT Portugal's level of involvement, co-operation or strategy in responding to inquiries by the authorities conducting the Rio Forte Investigation. Following the Completion Date, we intend to assess any risk of liability under applicable bribery and corruption laws, understand if there has been any historic misconduct which involved PT Portugal Group and take any remedial measures we deem necessary. We cannot assure you that additional information will not come to light which may materially and adversely affect the value of our investment in the PT Portugal Group or may expose any employees of PT Portugal to liability, sanctions or penalties by the authorities conducting the Rio Forte Investigation. If any such new information comes to light or if a member of management of PT Portugal is found liable and/or subject to sanctions or penalties, this may have a material adverse effect on the operations of PT Portugal and the value of your investment in the New Notes may suffer.

Risks Relating to Our Employees, Management, Majority Principal Shareholder and Related Parties

The loss of certain key executives and personnel or a failure to sustain a good working relationship with employee representatives, including workers' unions, could harm our business.

We depend on the continued contributions of our senior management and other key personnel and in particular, Patrick Drahi, who is our executive chairman and the principal shareholder of Altice S.A. There can be no assurance that we will

be successful in retaining their services, or that we would be successful in hiring and training suitable replacements without undue costs or delays. As a result, the loss of our executive chairman (including allocation of his time to any other business interests) or any of these key executives and employees could cause disruptions in our business operations, which could materially adversely affect our results of operations.

In our business, we rely on sales forces and call center employees to interface with the major part of our residential customers. Their reliability is key, as is our relationship with employee representatives. Some of our employees currently belong to organized unions and works councils, and there can be no assurance that more employees will not form or join unions in the future. An increase in the number of our unionised employees could lead to an increased likelihood of strikes, work stoppages and other industrial actions. In addition, we also face the risk of strikes called by employees of our key suppliers of materials or services as well as our installation providers, which could result in interruptions in the performance of our services. Although we monitor our labor relations, we cannot predict the extent to which future labor disputes or disturbance could disrupt our operations, cause reputational or financial harm or make it more difficult to operate our businesses.

You may be unable to effect service of process on the Issuers and/or members of our Board in the U.S. or enforce judgments obtained in U.S. courts for U.S. securities laws violations.

The Issuers are organized under the laws of the Grand Duchy of Luxembourg and do not have any material assets in the U.S. None of the members of the Issuers' Board will be residents of the U.S. and all or a majority of their assets are located outside the United States. As a result, it may not be possible for investors to effect service of process within the U.S. upon the Issuers or the members of their board of directors, or to enforce any judgments obtained in U.S. courts predicated upon civil liability provisions of the U.S. securities laws. In addition, the Issuers cannot assure you that civil liabilities predicated upon the federal securities laws of the U.S. will be enforceable in Luxembourg. The designation of a service of process may constitute a power of attorney/mandate in Luxembourg which can be terminated upon the occurrence of an insolvency event. Despite the service of process, summary proceedings may be initiated in Luxembourg.

The interests of Altice S.A., our majority shareholder, may conflict with our interests or your interests as holders of the New Notes.

Altice S.A. owns indirectly all of the voting interests in the Issuers as of the date of these Listing Particulars. The interests of Altice S.A. may conflict with your interests as holders of the New Notes. Altice S.A. will be able to appoint a majority of the Issuers' and each other group entity's board of directors and to determine our corporate strategy, management and policies. In addition, Altice S.A. will have control over our decisions to enter into any corporate transaction and will have the ability to prevent any transaction that requires the approval of shareholders regardless of whether holders of the New Notes believe that any such transactions are in their own best interests. For example, the shareholders could vote to cause us to incur additional indebtedness, to sell certain material assets or make dividends, in each case, so long as our debt instruments and the intercreditor agreements to which we are party permit. The incurrence of additional indebtedness would increase our debt service obligations and the sale of certain assets could reduce our ability to generate revenues, each of which could adversely affect the holders of the New Notes.

Risks Relating to the New Notes and the Structure

The Issuers are special purpose vehicle companies with limited assets other than their respective interests in the Existing Senior Notes Proceeds Loans, New Senior Notes Proceeds Loan, AH Proceeds Loan (as defined below), New AH Proceeds Loan, the Cool Proceeds Note, the 2012 Acquisition Note and the HOT Refinancing Notes and escrowed funds and are dependent upon cash from Altice International and its subsidiaries to meet its obligations.

Each Issuer is a special purpose vehicle company with no business or revenue generating operations other than the issuance of the relevant Existing Senior Notes and Existing Senior Secured Notes (together, the "Existing Notes") and New Notes. The only significant assets of each Issuer as of the Issue Date consisted of cash in its bank accounts and its interest in the respective Escrow Agreements and Escrow Accounts and, in the case of the Senior Notes Issuer, the Existing Senior Notes Proceeds Loans and the shares it holds in the Senior Secured Notes Issuer and, in the case of the Senior Secured Notes Issuer, the 2013 June AH Proceeds Loan and the 2013 December AH Proceeds Loan (together, the "AH Proceeds Loan"), the Cool Proceeds Note, the 2012 Acquisition Note and the HOT Refinancing Notes. Following any release of funds from the Escrow Accounts, the assets of the Senior Notes Issuer also will consist of its interest in the New Senior Notes Proceeds Loan and the assets of the Senior Secured Notes Issuer also will consist of its interest in the New AH Proceeds Loan. As such, the Senior Secured Notes Issuer will be wholly dependent upon payments under the New AH Proceeds Loan, the other proceeds loans referred to above and other payment from members of the Group in order to service its debt obligations under the New Senior Secured Notes and the New Senior Notes Proceeds Loans, and the Senior Notes Issuer will be wholly dependent upon payments from the Senior Secured Notes Issuer under the New Senior Notes Proceeds Loan and other payments from the Group to service its debt obligations under the New Senior

Notes to the extent it does not have cash to meet those obligations. Furthermore, the New Indentures and the Existing Indentures prohibit the Issuers from engaging in any activities other than certain limited activities. See “*Description of Senior Secured Notes—Certain Covenants—Limitation on Issuer Activities*”, “*Description of Senior Notes—Certain Covenants—Limitation on Issuer and Senior Secured Notes Issuer Activities*”, “*Description of Other Indebtedness—The 2012 Notes—The 2012 Senior Secured Notes*”, “*Description of Other Indebtedness—The 2012 Notes—The 2012 Senior Notes*”, “*Description of Other Indebtedness—The 2013 June Senior Notes*”, “*Description of Other Indebtedness—The 2013 June Senior Notes*”, “*Description of Other Indebtedness—The December 2013 Notes*”, “*Description of Other Indebtedness—The 2013 December Senior Secured Notes*”, “*Description of Other Indebtedness—The 2013 December Senior Notes*”.

The ability of members of the Group to make such payments will depend upon their cash flows and earnings which, in turn, will be affected by all of the factors discussed in these “Risk Factors” and elsewhere in these Listing Particulars. Furthermore, the payment of dividends and the making, or repayment, of loans and advances to the Issuers by Altice International’s subsidiaries are subject to various restrictions. Existing and future debt of certain of these subsidiaries may prohibit the payment of dividends or the making, or repayment, of loans or advances to the Issuers or its parent entities. In addition, the ability of any of Altice International’s direct or indirect subsidiaries to make certain distributions may be limited by the laws of the relevant jurisdiction in which the subsidiaries are organized or located, including financial assistance rules, corporate benefit laws, requirements that dividends must be paid out of reserves available for distribution and other legal restrictions which, if violated, might require the recipient to refund unlawful payments.

Although the New Indentures, the Existing Indentures, the 2013 Term Loan, the New Revolving Credit Facilities, the New Term Loan, the 2013 Guarantee Facility, the Existing Revolving Credit Facility Agreements and the trust deeds governing the Existing HOT Unsecured Notes limit, or will limit, the ability of Altice International’s subsidiaries to enter into future consensual restrictions on their ability to pay dividends and make other payments to the Issuers, there are significant qualifications and exceptions to these limitations. We cannot assure you that arrangements with Altice International’s subsidiaries and the funding permitted by the agreements governing existing and future indebtedness of Altice International’s subsidiaries will provide the Senior Secured Notes Issuer or Altice Holdings, Cool Holding, SPV1 and HOT with sufficient dividends, distributions or loans to fund payments on the New Senior Notes Proceeds Loan and AH Proceeds Loan, respectively, when due. See “*Description of Other Indebtedness*”, “*Description of Senior Secured Notes*” and “*Description of Senior Notes*”.

Altice International and most of the other Guarantors are holding companies and conduct no business of their own and will depend on payments from their direct and indirect subsidiaries to provide them with funds to meet their obligations under the Guarantees.

Each of Altice International, Cool Holding, SPV1, Altice Holdings, Altice West Europe, Altice Caribbean, Altice Portugal and Altice Bahamas is a holding company and conducts no business operations of its own and none of them has significant assets other than the shares it holds in its subsidiaries.

The ability of the direct or indirect subsidiaries of these Guarantors to pay dividends or to make other payments or advances to them will depend on their individual operating results and any statutory, regulatory or contractual restrictions to which they may be or may become subject and, in some cases, receipt of such payments or advances may be subject to onerous tax consequences. See “*—The granting of the Guarantees and the HOT Refinancing Notes Guarantees and security interests under the Collateral by Cool Holding, SPV1 and HOT may be considered a “distribution” under Israeli law*”.

Each of Cool Holding and SPV1 has no significant assets other than the shares it holds in HOT. We cannot assure you that HOT will report net profit in future years, which in light of legal requirements in Israel relating to the distribution of dividends, may impact its ability to make distributions to Cool Holding and/or SPV1 and in turn impact the ability of the Issuers to make payments of principal and interest on the New Notes. Under Israeli laws, a company may only make distributions up to the amount of the greater of (i) its retained earnings and (ii) its cumulative net income over the preceding eight quarters (and provided that it meets the solvency test (as defined under Israeli law)), which will be reduced by the amount of distributions already made to the extent not already reflected in, the calculation of distributable profits. As of September 30, 2014, HOT had limited distributable profits. Our other operating subsidiaries may have similar or other restrictions on the ability to pay dividends or make other distributions.

There can be no assurance that arrangements with Altice International’s, Cool Holding’s, SPV1’s, Altice Holdings’s, Altice West Europe’s, Altice Caribbean’s, Altice Portugal’s and Altice Bahamas’s direct and indirect subsidiaries and the funding permitted by the agreements governing existing and future indebtedness of such subsidiaries will provide Altice International, Cool Holding, SPV1, Altice Holdings, Altice West Europe, Altice Caribbean, Altice Portugal and Altice Bahamas, as applicable, with sufficient dividends, distributions or loans to fund payments under their respective Guarantees, and, in turn, fund payments by the Issuers under the New Notes, when due.

The New Notes may be treated as issued with original issue discount for U.S. federal income tax purposes.

The Dollar Senior Secured Notes, Euro Senior Secured Notes or New Senior Notes may be treated as having been issued with original issue discount for U.S. federal income tax purposes. An obligation generally is treated as having been issued with original issue discount if its stated principal amount exceeds its issue price by at least a defined *de minimis* amount. If a New Note is treated as issued with original issue discount, investors subject to U.S. federal income tax will be subject to tax on that original issue discount as ordinary income as it accrues, in advance of the receipt of cash payments attributable to that income (and in addition to qualified stated interest). See “*Tax Considerations—Certain U.S. Federal Income Tax Considerations*”.

Your right to receive payments under the New Senior Secured Notes or the New Senior Notes may be structurally or effectively subordinated to the claims of certain existing and future creditors of Altice International’s subsidiaries that do not guarantee the New Senior Secured Notes or the New Senior Notes upon the release of the proceeds thereof from the relevant escrow accounts.

As of the Issue Date, none of our subsidiaries guaranteed the New Notes, and on the release of the proceeds of the offering of the New Senior Secured Notes and the New Senior Notes from the applicable escrow accounts, not all of our subsidiaries will guarantee the New Notes. Generally, claims of creditors of a non Guarantor subsidiary, including trade creditors and claims of preference shareholders (if any) of the subsidiary, will have priority with respect to the assets and earnings of the subsidiary over the claims of creditors of its parent entity, including claims by holders of the New Notes under the Guarantees. In the event of any foreclosure, dissolution, winding up, liquidation, administration, reorganization or other insolvency or bankruptcy proceeding of any of our non Guarantor subsidiaries, holders of their debt (including the Senior Secured Notes Issuer as lender under the HOT Refinancing Notes, the Coditel Senior Facilities Agreement and any other intercompany loan to such subsidiaries and the holders of the other debt of such subsidiaries and their trade creditors) and their trade creditors will generally be entitled to payment of their claims from the assets of those subsidiaries before any assets are made available for distribution to its parent entity. As such, the New Notes and the Guarantees will each be structurally subordinated to the creditors (including trade creditors) and preference shareholders (if any) of our non Guarantor subsidiaries.

Holders of the New Senior Secured Notes will have the indirect benefit of the security granted under the HOT Refinancing Notes, the HOT Refinancing Notes Guarantees and the Coditel Senior Facilities Agreement which will be pledged by the Senior Secured Notes Issuer for the benefit of holders of the New Senior Secured Notes. The obligations under the HOT Refinancing Notes and the HOT Refinancing Notes Guarantees will rank senior in right of payment to all other obligations of HOT and the HOT Refinancing Notes Guarantors up to the lesser of the value of the assets securing the HOT Refinancing Notes and the amount of obligations outstanding thereunder. To the extent the amounts outstanding under the HOT Refinancing Notes exceed the value of the assets securing it, such excess amounts will rank *pari passu* in right of payment with all other senior unsecured obligations of HOT and the HOT Refinancing Notes Guarantors, including the Existing HOT Unsecured Notes and claims of any trade creditors. With respect to amounts in excess of the amount outstanding under the HOT Refinancing Notes, the New Senior Secured Notes and the Senior Secured Note Guarantees will be structurally subordinated to the obligations of HOT and its subsidiaries, including with respect to the Existing HOT Unsecured Notes and claims of any trade creditors. In addition, the New Senior Notes and the Senior Notes Guarantees will be structurally subordinated to the subsidiaries of Cool Holding that do not guarantee the New Senior Notes, including HOT and its subsidiaries. The New Senior Notes will not benefit from any security interest over the HOT Refinancing Notes. In addition, the obligations under the Coditel Senior Facilities Agreement will rank senior in right of payment to all other obligations of the obligors thereunder up to the lesser of the value of the assets securing the Coditel Senior Facilities Agreement and the amount of obligations outstanding thereunder. To the extent the amounts outstanding under the Coditel Senior Facilities Agreement exceed the value of the assets securing it, such excess amounts will rank *pari passu* in right of payment with all other senior unsecured obligations of the obligors thereunder, including claims of any trade creditors. With respect to amounts in excess of the amount outstanding under the Coditel Senior Facilities Agreement, the New Senior Secured Notes and the Senior Secured Note Guarantees will be structurally subordinated to the obligations of the obligors under the Coditel Senior Facilities Agreement, including with respect to claims of any trade creditors. The New Senior Notes will not benefit from any security interest over the Coditel Senior Facilities Agreement.

HOT Mobile and its subsidiary are not guarantors of the HOT Refinancing Notes and will not be guarantors of the New Notes and, as a result, the New Notes will be structurally subordinated to all obligations, including with respect to claims of trade creditors, of HOT Mobile and its subsidiary, and any other subsidiary of HOT that does not guarantee the HOT Refinancing Notes or the New Notes. In the event of an insolvency, liquidation or other reorganization of any of Altice International’s subsidiaries that are not Guarantors of the New Notes, holders of their debt (including the Senior Secured Notes Issuer as lender under the HOT Refinancing Note, the Coditel Senior Facility and any other intercompany loan to such subsidiaries and the holders of the other debt of such subsidiaries and their trade creditors) will typically be entitled to payment of their claims from the assets of those subsidiaries before any assets are made available for distribution to Altice International or the other Guarantors.

The Senior Note Guarantees will be subordinated to certain of our existing and future senior debt.

Each of the Senior Note Guarantees will be a senior subordinated obligation of the relevant Senior Notes Guarantor. In addition, no enforcement action with respect to the Senior Note Guarantees (or any future guarantee of the New Senior Notes) may be taken unless (subject to certain limited exceptions): (i) there is an acceleration of the 2012 Revolving Credit Facility, the Existing Senior Secured Notes, the New Senior Secured Notes, the 2013 Term Loan, the 2013 Revolving Credit Facility, the 2013 Guarantee Facility, the New Revolving Credit Facilities, the New Term Loan or any of our other senior secured debt; (ii) there is a default outstanding under the New Senior Notes for a period of 179 days and the agent under the New Super Senior Revolving Credit Facility, the New Pari Passu Revolving Credit Facility, the New Term Loan, 2012 Revolving Credit Facility, the 2013 Revolving Credit Facility and the 2013 Term Loan, the trustee of the Existing Senior Secured Notes, the Trustee of the New Senior Secured Notes or the creditor representative for holders of other senior secured debt has received written notice of such default from the Trustee of the New Senior Notes; (iii) an enforcement action has been taken with respect to certain secured liabilities; provided that the New Senior Notes of the Trustee and holders of the New Senior Notes will be limited to taking the same action; or (iv) with respect to any enforcement action in relation to a particular Senior Notes Guarantor, an insolvency event has occurred with respect to such Senior Notes Guarantor. Please see “*Description of Other Indebtedness—The Intercreditor Agreement*”.

Upon any distribution to the creditors of a Senior Notes Guarantor in liquidation, administration, bankruptcy moratorium of payments, dissolution or other winding up of such Senior Notes Guarantor, the holders of senior debt of such Senior Notes Guarantor that are party to the Intercreditor Agreement will be entitled to be paid in full before any payment may be made with respect to the relevant Senior Note Guarantee. As a result, holders of Senior Notes may receive less, ratably, than the holders of such senior debt of the Senior Notes Guarantors, including the lenders under the New Super Senior Revolving Credit Facility, the New Pari Passu Revolving Credit Facility, the New Term Loan, the 2012 Revolving Credit Facility, the 2013 Revolving Credit Facility, the 2013 Guarantee Facility and the 2013 Term Loan, certain hedging counterparties and holders of the Existing Senior Secured Notes and the New Senior Secured Notes.

The value of the Collateral may not be sufficient to satisfy our obligations under the New Notes and such Collateral may be reduced or diluted under certain circumstances, which may be time consuming and cumbersome, and certain Collateral and Guarantees will be limited to a specified maximum amount.

In the event of foreclosure on the Collateral, the proceeds from the sale of the Collateral that secures the New Senior Secured Notes and/or the New Senior Notes may not be sufficient to satisfy our obligations under the New Senior Secured Notes or the New Senior Notes, as applicable. The value of the Collateral and the amounts to be received upon a sale of such Collateral will depend upon many factors, including, among others, the ability to sell any or all of our subsidiaries’ shares in an ordinary sale and the availability of buyers. In addition, the Senior Notes Collateral may be illiquid and may have no readily ascertainable market value. Although the New Senior Secured Notes will indirectly benefit from collateral securing certain intercompany debt (including collateral security the HOT Refinancing Notes and the Coditel Senior Facilities Agreement) through the assignment of such intercompany debt, the New Senior Secured Notes will not have a direct benefit of such collateral and the Security Agent will be unable to enforce over such collateral except if an event of default has occurred and is continuing under the relevant intercompany debt. See “*—The guarantees of, and the Collateral securing, certain intercompany debt that is pledged to secure our senior secured debt, including the New Senior Secured Notes*” and guarantees thereof, will not directly secure the New Senior Secured Notes. In addition, the New Senior Notes will be secured by the Senior Notes Collateral, which does not include the shares of any of Altice International’s subsidiaries, other than the Senior Notes Issuer, Cool and Altice Holdings, or any Pledged Proceeds Note.

Certain Collateral and Guarantees will be limited to an agreed maximum amount. The maximum aggregate amount of obligations (i) guaranteed by Altice Portugal and Cabovisão and (ii) secured by the Cabovisão Security (including the pledge over the shares in PT Portugal, to be granted by Altice Portugal within 10 Business Days following the PT Portugal Acquisition), which limitation applies to all indebtedness so guaranteed and/or secured on an aggregate basis, is €95 million. The maximum amount of obligations secured or guaranteed by PT Portugal will be € 4,634.4 million and PT OpCo €968.4 million. As a result, these entities will not have a direct obligation to the holders of the New Notes once these limits have been reached, as applicable.

No appraisal of the fair market value of the Collateral has been made in connection with this offering of New Notes. The book value of the Collateral should not be relied on as a measure of realizable value for such assets. The value of the Collateral could be impaired in the future as a result of changing economic and market conditions, our failure to successfully implement our business strategy, competition and other factors. The Collateral may include intangible or other illiquid assets that by their nature may not have a readily ascertainable market value, whose value to other parties may be less than its value to us, or may not be readily saleable or, if saleable, there may be substantial delays in their liquidation. In addition, the value of the Collateral may decrease because of obsolescence, impairment or certain casualty events.

In the event of a liquidation, insolvency, foreclosure, bankruptcy, reorganization or similar proceeding, the value of the Collateral and the amount that may be received upon a sale of Collateral will depend upon many factors including, among others, the condition of the Collateral and our industry, the ability to sell the Collateral in an orderly sale, market and economic conditions, whether the business is sold as a going concern, the availability of buyers and other factors. With respect to any shares of our subsidiaries pledged to secure the New Notes and the Guarantees, such shares may also have limited value in the event of a bankruptcy, insolvency, liquidation, winding up or other similar proceedings in relation to the entity's shares that have been pledged because all of the obligations of the entity whose shares have been pledged must first be satisfied, leaving little or no remaining assets in the pledged entity. As a result, the creditors secured by a pledge of the shares of these entities may not recover anything of value in the case of an enforcement sale. In addition, courts could limit recoverability with respect to the Collateral if they deem a portion of the interest claim usurious in violation of applicable public policy. As a result, liquidating the Collateral may not produce proceeds in an amount sufficient to pay any amounts due on the New Notes. We cannot assure you of the value of the Collateral or that the net proceeds received upon a liquidation, foreclosure, bankruptcy, reorganization or similar proceeding would be sufficient to repay all amounts due on the New Notes. If the proceeds of Collateral were not sufficient to repay amounts outstanding under the New Notes, then holders of the New Notes (to the extent not repaid from the proceeds of the sale of the Collateral) would only have an unsecured claim against our remaining assets. See *"—It may be difficult to realize the value of the Collateral securing the New Notes"*.

The New Indentures permit the granting of certain liens other than those in favor of the holders of the New Notes on the relevant Collateral securing the New Notes. To the extent that holders of other secured indebtedness or third parties enjoy such liens, including statutory liens, whether or not permitted by the New Indentures or the security documents governing the Collateral, such holders or third parties may have rights and remedies with respect to the Collateral that, if exercised, could reduce the proceeds available to satisfy our obligations under the New Notes, to the extent such New Notes are secured by such Collateral. Moreover, if the Issuers issue additional Notes under the New Indentures or Existing Indentures, holders of such additional Notes would benefit from the same Collateral as the holders of the relevant series of Notes being offered hereby, thereby diluting holders of Notes' ability to benefit from the liens on the Collateral securing their series of Notes.

The Intercreditor Agreement will provide for detailed enforcement mechanisms with respect to the Collateral. Please see *"Description of Other Indebtedness—Intercreditor Agreement"*.

The security interests in the Collateral will be granted to the Security Agent rather than directly to the holders of the New Notes, as applicable. The ability of the Security Agent to enforce certain of the Collateral may be restricted by local law.

The security interests in the Collateral that will secure our obligations under the New Notes (other than the Cabovisão Security and ONI Security deemed to have been granted directly in favor of the secured creditors) and the obligations of the Guarantors under the Guarantees will not be granted directly to the holders of the New Notes but will be granted only in favor of the Security Agent. The security interests in any collateral that secures any of our non Guarantor subsidiaries under any secured intercompany debt (including the collateral securing the HOT Refinancing Notes, the HOT Refinancing Notes Guarantees and the Coditel Senior Facilities Agreement) will not be granted directly to the Senior Secured Notes Issuer but will be granted in favor of the security agent (if any) thereunder. See *"—The guarantees of, and the Collateral securing, certain intercompany debt that is pledged to secure our senior secured debt, including the New Senior Secured Notes and guarantees thereof, will not directly secure the New Senior Secured Notes"*. The New Indentures provide (along with the Intercreditor Agreement) that only the Security Agent has the right to enforce the security documents. As a consequence, holders of the New Notes will not have direct security interests (other than the Collateral governed by Portuguese Law deemed to have been granted directly in favor of the secured creditors) and will not be entitled to take enforcement action in respect of the Collateral securing such series of New Notes, except through the Trustee, who will (subject to the provisions of the New Indentures and the Intercreditor Agreement) provide instructions to the Security Agent in respect of the Collateral securing such series of New Notes.

The appointment of a foreign security agent will be recognized under Luxembourg law, (i) to the extent that the designation is valid under the law governing such appointment and (ii) subject to possible restrictions, depending on the type of the security interests. Generally, according to article 2(4) of the Luxembourg Act dated August 5, 2005 concerning financial collateral arrangements, as amended, a security (financial collateral) may be provided in favor of a person acting on behalf of the collateral taker, a fiduciary or a trustee in order to secure the claims of third party beneficiaries, whether present or future, provided that these third party beneficiaries are determined or may be determined. Without prejudice to their obligations vis à vis third party beneficiaries of the security, persons acting on behalf of beneficiaries of the security, the fiduciary or the trustee benefit from the same rights as those of the direct beneficiaries of the security aimed at by such law.

The security documents governing the granting of the Collateral will be governed by the laws of a number of jurisdictions. Bankruptcy laws could prevent the Security Agent on behalf of the holders of the New Notes from

repossessing and disposing of the Collateral upon the occurrence of an event of default if a bankruptcy proceeding is commenced by or against the relevant grantor of such Collateral before the Security Agent repossesses and disposes of the Collateral. See “—Enforcing your rights as a holder of the New Notes or under the Guarantees or security across may prove difficult or provide less protection than U.S. bankruptcy law”.

The holders of the New Senior Secured Notes’ ability to recover under the Senior Secured Collateral and the Senior Secured Notes Guarantees may be limited. Before any amounts are available to repay the New Senior Secured Notes, lenders under our 2012 Revolving Credit Facility, our 2013 Revolving Credit Facility, the New Super Senior Revolving Credit Facility and certain hedge counterparties will have a right to be repaid with the proceeds realized following the enforcement of all or part of the Senior Secured Collateral.

The obligations under the New Senior Secured Notes and the Senior Secured Notes Guarantees are secured by security interests over the Senior Secured Collateral which were granted to secure obligations under the Senior Secured Debt pursuant to the Intercreditor Agreement. Pursuant to the Intercreditor Agreement, the lenders under our 2012 Revolving Credit Facility, 2013 Revolving Credit Facility, the New Super Senior Revolving Credit Facility and such hedging arrangements will have priority over the holders of the New Senior Secured Notes with respect to the proceeds from the enforcement of the Senior Secured Collateral. As a result, the claims of the holders of the New Senior Secured Notes will be contractually subordinated to the rights of our existing and future secured creditors who have priority in respect of proceeds from enforcement of the liens over assets that constitute Senior Secured Collateral to the extent of the value of such assets. In addition, the creditors under our 2012 Revolving Credit Facility, 2013 Revolving Credit Facility, the New Super Senior Revolving Credit Facility and such hedging arrangements will have priority over any amounts received from the sale of any assets of the Senior Secured Notes Issuer or a Senior Secured Guarantor pursuant to an insolvency event or certain other distressed disposals of the Senior Secured Collateral pursuant to the provisions on the Intercreditor Agreement. As such, you may not be able to recover on the Senior Secured Collateral if the claims of the lenders under our 2012 Revolving Credit Facility, 2013 Revolving Credit Facility, the New Super Senior Revolving Credit Facility and such hedging obligations are greater than the proceeds realized from any enforcement of the security interests over the Senior Secured Collateral.

In addition, the Senior Secured Collateral may also secure certain future indebtedness, including certain hedging obligations, that are permitted to be incurred under the New Senior Secured Notes Indenture and our other debt agreements on a *pari passu* basis, and certain of that indebtedness and those hedging obligations may have similar priority to the proceeds of the enforcement of, or certain distressed disposals of, the Senior Secured Collateral. Any proceeds from an enforcement sale of the Senior Secured Collateral by any creditor will, after all obligations under our 2012 Revolving Credit Facility, 2013 Revolving Credit Facility, the New Super Senior Revolving Credit Facility and such priority hedging obligations have been paid from such recoveries, be applied pro rata in repayment of the New Senior Secured Notes and other senior indebtedness secured on such Senior Secured Collateral, including the Existing Senior Secured Notes. Our ability to incur additional debt in the future secured on the Senior Secured Collateral may have the effect of diluting the ratio of the value of such Senior Secured Collateral to the aggregate amount of the obligations secured by the Senior Secured Collateral. In addition, claims of any secured creditors which are secured by assets that do not also secure the New Senior Secured Notes will have priority with respect to such assets over the claims of holders of the New Senior Secured Notes. As such, the claims of the holders of the New Senior Secured Notes will be effectively subordinated to the rights of such secured creditors to the extent of the value of the assets securing such indebtedness.

Subject to certain conditions, any security interest in the Senior Secured Collateral will be automatically released at the time of an enforcement sale of the pledged entity or the assets or shares of any direct or indirect parent entity of such subsidiary. Following such a sale, the Trustee of the New Senior Secured Notes and the holders of the New Senior Secured Notes will have no claims in relation to such entity and its direct and indirect subsidiaries under the New Senior Secured Notes or any Senior Secured Notes Guarantee. See “Description of Other Indebtedness—The Intercreditor Agreement” for further information.

The claims of the holders of the New Senior Notes will be effectively subordinated to the rights of our existing and future secured creditors to the extent of the value of the assets constituting Senior Secured Collateral.

The New Senior Notes and the Senior Note Guarantees will be secured by the Senior Notes Collateral, which will be substantially less than the Senior Secured Collateral. The Senior Secured Debt and the related guarantees will also be secured by senior pledges over all of the Senior Notes Collateral (other than the share pledge over the shares of the Senior Notes Issuer). The value of the Senior Secured Collateral (other than the share pledge over the shares of the Senior Notes Issuer) and Senior Notes Collateral will not be available to pay the obligations under the New Senior Notes and the Existing Senior Notes until the obligations under the Senior Secured Debt and the related guarantees of the foregoing have been satisfied.

The New Senior Notes Indenture allows us and our subsidiaries to incur a limited amount of secured indebtedness which will be effectively senior to the New Senior Notes. In the event of any distribution or payment of our assets in any foreclosure, dissolution, winding up, liquidation, administration, reorganization, or other insolvency or bankruptcy proceeding, holders of such secured indebtedness will have a priority claim to our assets that constitute their collateral. In these circumstances, we cannot assure you that there will be sufficient assets to pay amounts due on the New Senior Notes. As a result, holders of New Senior Notes may receive less, ratably, than holders of other secured indebtedness.

It may be difficult to realize the value of the Collateral securing the New Notes.

On the Completion Date, the holders of the New Notes will benefit from security interests in the Collateral that secures the applicable series of New Notes, which in the case of the New Senior Secured Notes, includes the Senior Secured Notes Issuer's rights under certain secured intercompany debt (including the HOT Refinancing Notes and the Coditel Senior Facilities Agreement).

The Collateral will be subject to any and all exceptions, defects, encumbrances, liens, loss of legal perfection and other imperfections permitted under the New Indentures, the Existing Indentures and/or the Intercreditor Agreement and accepted by other creditors that have the benefit of first ranking security interests in the Collateral securing the New Notes from time to time, whether on or after the date the New Notes are first issued. The Initial Purchasers have neither analyzed the effect of, nor participated in any negotiations relating to, such exceptions, defects, encumbrances, liens and other imperfections. The existence of any such exceptions, defects, encumbrances, liens, loss of legal perfection and other imperfections could adversely affect the value of the Collateral, as well as the ability of the Security Agent to realize or foreclose on such Collateral. Furthermore, the first-ranking ranking of security interests can be affected by a variety of factors, including, among others, the timely satisfaction of perfection requirements, statutory liens or recharacterization under the laws of certain jurisdictions. In addition, before the pledge over the shares of ODO will secure the New Senior Secured Notes, Indotel will need to approve both the granting of the pledge as well as the enforceability of the pledge. We cannot assure you that such approval will be granted, even if Indotel approves the ODO Acquisition.

The security interests of the Security Agent will be subject to practical problems generally associated with the realization of security interests over real or personal property such as the Collateral. For example, the Security Agent may need to obtain the consent of a third party, including that of competent regulatory authorities or courts, to enforce a security interest. We cannot assure you that the Security Agent will be able to obtain any such consents. We also cannot assure you that the consents of any third parties will be given when required to facilitate a foreclosure on such assets. Accordingly, the Security Agent may not have the ability to foreclose upon those assets, and the value of the Collateral may significantly decrease.

Furthermore, enforcement procedures and timing for obtaining judicial decisions in Portugal, Luxembourg, France, Israel, Switzerland, the Bahamas, the Dominican Republic and the United Kingdom may be materially more complex and time consuming than in equivalent situations in jurisdictions with which investors may be familiar. See *"Enforcing your rights as a holder of the New Notes or under the Guarantees or security across multiple jurisdictions may prove difficult or provide less protection than U.S. bankruptcy law"*. In particular, the enforcement and realization of any security interest under the Collateral which is governed by Israeli law will be subject to the supervision of the Israeli courts or the Israeli Office of Execution of Judgments and their practices. Enforcement and realization of security interests in Israel is subject to certain mandatory principles. The general rule under Israeli law is that any enforcement or realization of a fixed pledge or charge or a floating charge is required to be made in accordance with and subject to a court order, with certain exceptions for collateral deposited with the creditor, collateral with respect to which the law specifies another manner of realization and collateral which consists of rights. See *"—Rights of holders of New Notes to enforce, secure and realize their rights under the Collateral may be adversely affected in Israeli insolvency proceedings"*. Furthermore, enforcement or realization of rights with respect to the pledges of the shares of Cool Holding and SPV1 is subject to the prior approval of and supervision by the Israeli Ministry of Communications and enforcement or realization of rights with respect to the pledges of the shares of Tricom and ODO is subject to the prior approval of Indotel, in each case which may be time consuming and cumbersome.

In addition, our business requires a variety of national and local permits and licenses. The continued operation of properties that comprise part of the Collateral and that depend on the maintenance of such permits and licenses may be prohibited or restricted. Our business is subject to regulations and permitting requirements and may be adversely affected if we are unable to comply with existing regulations or requirements or if changes in applicable regulations or requirements occur. In the event of foreclosure, the grant of permits and licenses may be revoked, the transfer of such permits and licenses may be prohibited or may require us to incur significant cost and expense. Furthermore, we cannot assure you that the applicable governmental authorities will consent to the transfer of all such permits. If the regulatory approvals required for such transfers are not obtained, are delayed or are economically prevented, the foreclosure may be delayed, a temporary or lasting shutdown of operations may result, and the value of the Collateral may be significantly decreased.

There are circumstances other than repayment or discharge of the New Notes under which the Collateral and the Guarantees will be released automatically, without your consent or the consent of the Trustee.

Under various circumstances, the Guarantees of the Guarantors will be released. See “*Description of Senior Notes—The Note Guarantees*” and “*Description of Senior Secured Notes—The Note Guarantees*”. In addition, under various circumstances, the Issuers and the Guarantors will be entitled to release the security interests in respect of the Collateral securing the New Notes and the Guarantees.

We will also be permitted to release and/or re-take any lien on any Collateral to the extent otherwise permitted by the terms of the New Indentures, the security documents governing the Collateral, the Existing Indentures or the Intercreditor Agreement or any additional intercreditor agreement. Such a release and re taking of Collateral may give rise to the start of a new hardening period in respect of the Collateral. Under certain circumstances, other creditors, insolvency administrators or representatives or courts could challenge the validity or enforceability of the grant of the Collateral. Any such challenge, if successful, could potentially limit your recovery in respect of the Collateral and thus reduce your recovery under the New Notes. See “*Description of Senior Notes—Notes Security*” and “*Description of Senior Secured Notes—Notes Security*”.

We will in most cases have control over the Collateral securing the New Notes and the sale of particular assets could reduce the pool of assets securing such debt.

The security documents governing the Collateral will allow ourselves and the Guarantors, as applicable, to remain in possession of, retain exclusive control over, freely operate, and collect, invest and dispose of any income from the Collateral. So long as no default or event of default under the New Indentures would result therefrom, we and the Guarantors may, among other things, without any release or consent by the Security Agent, conduct ordinary course activities with respect to the Collateral, such as selling, factoring, abandoning or otherwise disposing of Collateral and making ordinary course cash payments, including repayments of debt. Any of these activities could reduce the value of the Collateral and consequently the amounts payable to you from proceeds of any sale of Collateral in the case of an enforcement of the liens.

The guarantees of, and the Collateral securing, certain intercompany debt that is pledged to secure our senior secured debt, including the New Senior Secured Notes and guarantees thereof, will not directly secure the New Senior Secured Notes.

The guarantees of, and the collateral securing certain intercompany debt (including the HOT Refinancing Notes and the Coditel Senior Facilities Agreement) that is pledged to secure our senior secured debt, including the New Senior Secured Notes and guarantees thereof, will not directly secure the New Senior Secured Notes. Instead, such security interests are granted in favor of the security agent under the relevant intercompany debt (if any) or the relevant lender thereunder, and the first-ranking pledge over such intercompany debt will in turn serve as part of the Senior Secured Collateral securing the obligations of the Senior Secured Notes Issuer under the New Senior Secured Notes. Holders of the New Senior Notes will not benefit from any interest in such pledged intercompany debt. Only the security agent or lender thereunder (as applicable) will be able to enforce the security interests in the collateral securing such intercompany debt in accordance with its terms, including in certain cases upon the occurrence of an event of default that is continuing under such intercompany indebtedness. As a result, upon the occurrence of an event of default under the New Senior Secured Notes, the New Senior Secured Notes Trustee and the holders of the New Senior Secured Notes may not have the right to enforce such security interests in the collateral securing such such intercompany indebtedness (including the HOT Refinancing Notes Collateral and the collateral securing the Coditel Senior Facilities Agreement) and will only have the right to enforce the first-ranking pledge over such intercompany indebtedness. The holders of the New Senior Secured Notes must then rely on the ability of the Senior Secured Notes Issuer to enforce its rights under the relevant intercompany indebtedness upon an event of default thereunder (as applicable) in order to access such collateral. An event of default under the New Senior Secured Notes or the New Senior Notes may not result in an event of default under our secured intercompany indebtedness. Moreover, the borrowers and guarantors under such intercompany indebtedness will not have any liability to the holders of the New Notes in an event of default under the New Indentures, except to the extent they are Guarantors. However, if an event of default occurs and is continuing under the relevant intercompany indebtedness, holders of the New Senior Secured Notes will indirectly benefit to the extent of the Senior Secured Notes Issuer or a Guarantor is a lender under or purchaser of such intercompany indebtedness. This indirect claim over the collateral securing such intercompany indebtedness could delay or make more costly any realization of such collateral. Furthermore, because the New Indentures and the New Notes are governed by New York law and the collateral securing such intercompany indebtedness are governed by the laws of other jurisdictions, realization may be further delayed by court proceedings in multiple jurisdictions. See “*Enforcement of Judgments*”.

There may be circumstances in which a breach of the covenants under the New Senior Secured Notes Indenture does not result in a corresponding breach under certain of our secured intercompany indebtedness that is pledged to secure the New Senior Secured Notes. In such circumstances, the holders of the New Senior Secured Notes would only be entitled

to enforce the assignment over such intercompany indebtedness in accordance with the Intercreditor Agreement; however, they would not be entitled to accelerate such intercompany indebtedness or take enforcement action in respect of the collateral securing such intercompany indebtedness. In addition, there may be circumstances in which such intercompany indebtedness is in default and there is not a default outstanding under the New Indentures. In such circumstances, the holders of the New Senior Secured Notes and the other creditors secured by the assignment over such intercompany indebtedness would not be entitled to take any enforcement action with respect to such intercompany indebtedness. See “*Description of other Indebtedness—Pledged Proceeds Loan—HOT Refinancing Notes—HOT Refinancing Term Note—Limitation of Liability*”.

The dual nationality of Cool Holding may impact the ability to enforce the pledges over the share capital of Cool Holding.

Cool Holding is an entity which has a registered office in Luxembourg and a registered office in the State of Israel. It is registered with both the Luxembourg Trade and Companies Register and the Israeli Registrar of Companies and according to its articles of association its principal place of management and control is Luxembourg. Cool Holding is therefore subject to both Luxembourg laws and Israeli laws and is deemed to have a dual nationality.

The dual nationality of Cool Holding may impact the ability to enforce the pledges over the share capital of Cool Holding depending on whether enforcement will be sought under the Luxembourg law pledges or under the Israeli law pledges, as enforcement formalities and requirements under these laws may differ.

Likewise, there may be limited recognition by a Luxembourg court or an Israeli court of an enforcement of the pledges of the share capital of Cool Holding when performed in the respective other jurisdiction, because each court will consider that, in accordance with its own international private law rules, the pledges should have been enforced in its own jurisdiction and in accordance with its own governing laws, rather than those of the other jurisdiction. Furthermore, due to the dual nationality of Cool Holding, there may be an uncertainty as to which of the Luxembourg or the Israeli law pledges it is appropriate to enforce at the time of enforcement.

The granting of the Guarantees and the HOT Refinancing Notes Guarantees and security interests under the Collateral by Cool Holding, SPV1 and HOT may be considered a “distribution” under Israeli law.

The granting of the Guarantees and the HOT Refinancing Notes Guarantees and security interests under the Collateral to secure obligations under the New Notes, to the extent that no valuable consideration has been paid to the respective guarantor against the granting of the Guarantees, the HOT Refinancing Notes Guarantees or the security interests in the Collateral, as applicable, may be considered as a “distribution” under Israeli law, and accordingly will be subject to Cool Holding, SPV1 or HOT being able to meet all of its obligations when they become due (the “Solvency Test”) and certain distributable reserves criteria, as set by Israeli law. See “*Limitation on Validity and Enforceability of the Guarantees and the Security Interests—Israel—Limitation on Distributions and Fiduciary Duties*”. Cool Holding, SPV1 or HOT may apply to a competent Israeli court to approve a distribution notwithstanding its non compliance with the distributable reserves criteria if it complies with the Solvency Test. However, approval of distributions by an order of a court is subject to objections that may be raised by other creditors whose interests may be jeopardized by the distribution.

Enforcing your rights as a holder of the New Notes or under the Guarantees or security across multiple jurisdictions may prove difficult or provide less protection than U.S. bankruptcy law.

The New Notes were issued by the Issuers, each of which is incorporated under the laws of the Grand Duchy of Luxembourg. The New Notes will be guaranteed by the Guarantors, which are incorporated under the laws of Portugal, Luxembourg, Israel, Switzerland, the Bahamas, and the Dominican Republic. In the event of a bankruptcy, insolvency or similar event, proceedings could be initiated in any, all or any combination of the above jurisdictions. Such jurisdictions may not be as favorable to investors as the laws of the United States or other jurisdictions with which investors are familiar, and proceedings in these jurisdictions are likely to be complex and costly for creditors and otherwise may result in greater uncertainty and delay regarding the enforcement of your rights. Your rights under the New Notes, the Guarantees and the Collateral will be subject to such bankruptcy, insolvency and administrative laws and there can be no assurance that you will be able to effectively enforce your rights in such complex, multiple bankruptcy, insolvency or similar proceedings. See “*—Each Guarantee will be subject to certain limitations on enforcement and may be limited by applicable laws or subject to certain defenses that may limit its validity and enforceability*”.

In addition, in the event that one or more of the Issuers, the Guarantors and any future guarantor, if any, or any other of our subsidiaries experiences financial difficulty, the bankruptcy, insolvency, administrative and other laws of the Issuers and the Guarantors’ jurisdictions of organization and location of assets may be materially different from, or in conflict with, each other and those of the United States, including in the areas of rights of creditors, priority of governmental and other creditors, ability to obtain post petition interest and duration of the proceedings. The application of these laws, or any conflict among them, could call into question whether the law of any particular jurisdiction should apply, and may

adversely affect your ability to enforce your rights under the New Notes, the Guarantees and the Collateral in those jurisdictions or limit any amounts that you may receive. See “*Enforcement of Judgments*” with respect to certain of the jurisdictions mentioned above.

Each Guarantee will be subject to certain limitations on enforcement and may be limited by applicable laws or subject to certain defenses that may limit its validity and enforceability.

Each Guarantee provides the holders of the New Notes with a direct claim against the relevant Guarantor. However, the New Indentures provide that each Guarantee will be limited to the maximum amount that may be guaranteed by the relevant Guarantor without, among other things, rendering the relevant Guarantee, as it relates to that Guarantor, voidable or otherwise ineffective or limited under applicable law or causing the officers of the Guarantor to incur personal civil or criminal liability, and enforcement of each such Guarantee would be subject to certain generally available defenses. See “*Limitation on Validity and Enforceability of the Guarantees and the Security Interests*”.

Enforcement of any of the Guarantees against any Guarantor, or of the security interests in respect thereof, will be subject to certain defenses available to Guarantors in the relevant jurisdiction. Although laws differ among various jurisdictions, in general, under bankruptcy or insolvency law and other laws, a court could (i) void or invalidate all or a portion of a Guarantor’s obligations under its Guarantee or the security interests in respect thereof, (ii) direct that the holders of the New Notes return any amounts paid under a Guarantee to the relevant Guarantor or to a fund for the benefit of the Guarantor’s creditors or (iii) take other action that is detrimental to you, typically if the court found that:

- the relevant Guarantee was incurred with actual intent to give preference to one creditor over another, hinder, delay or defraud creditors or shareholders of the relevant Guarantor or, in certain jurisdictions, when the granting of the Guarantee has the effect of giving a creditor a preference or when the recipient was aware that the relevant Guarantor was insolvent when it granted the relevant Guarantee;
- the relevant Guarantor did not receive fair consideration or reasonably equivalent value or corporate benefit for the relevant Guarantee and such Guarantor was: (i) insolvent or rendered insolvent because of the relevant Guarantee; (ii) undercapitalized or became undercapitalized because of the relevant Guarantee; or (iii) intended to incur, or believed that it would incur, indebtedness beyond its ability to pay at maturity;
- the relevant Guarantee was held to exceed financial assistance rules or the corporate objects of the Guarantor or not to be in the best interests or for the corporate benefit of the Guarantor; or
- the amount paid or payable under the relevant Guarantee was in excess of the maximum amount permitted under applicable law.

These or similar laws may also apply to any future guarantee granted by any of our subsidiaries pursuant to the New Indentures. Limitations on the enforceability of judgments obtained in New York courts in such jurisdictions could limit the enforceability of any Guarantee against any Guarantor.

We cannot assure you which standard a court would apply in determining whether a Guarantor was “insolvent” at the relevant time or that, regardless of the method of the valuation, a court would not determine that a Guarantor was insolvent on that date, or that a court would not determine, regardless of whether or not a Guarantor was insolvent on the date its Guarantee was issued, that payments to holders of the New Notes constituted preferences, fraudulent transfers or conveyances on other grounds.

The measures of insolvency for purposes of fraudulent transfer laws vary depending upon applicable governing law. Generally, an entity would be considered insolvent if, at the time it incurred indebtedness:

- the sum of its debts, including contingent liabilities, is greater than the fair value of all its assets;
- the present fair saleable value of its assets is less than the amount required to pay the probable liability on its existing debts and liabilities, including contingent liabilities, as they become due; or
- it cannot pay its debts as they become due.

The liability of each Guarantor under its Guarantee will be limited to the amount that will result in such Guarantee not constituting a preference, fraudulent conveyance or improper corporate distribution or otherwise being set aside. However, there can be no assurance as to what standard a court will apply in making a determination of the maximum liability of each Guarantor. There is a possibility that the entire Guarantee may be set aside, in which case the entire liability may be extinguished.

If a court decided that a Guarantee was a preference, fraudulent transfer or conveyance and voided such Guarantee, or held it unenforceable for any other reason, you may cease to have any claim in respect of the relevant Guarantor and would be a creditor solely of the Issuers and, if applicable, of any other Guarantor under the relevant Guarantee that has not been declared void. In the event that any Guarantee is invalid or unenforceable, in whole or in part, or to the extent the agreed limitation of the Guarantee obligations apply, the New Notes would be effectively subordinated to all liabilities of the applicable Guarantor, and if we cannot satisfy our obligations under the New Notes or any Guarantee is found to be a preference, fraudulent transfer or conveyance or is otherwise set aside, we cannot assure you that we can ever repay in full any amounts outstanding under the New Notes. See *“Limitation on Validity and Enforceability of the Guarantees and the Security Interests”*.

We may not be able to obtain enough funds necessary to finance an offer to repurchase the New Notes upon the occurrence of certain events constituting a change of control triggering event (as defined in the New Indentures) as required by the New Indentures.

Upon the occurrence of certain events constituting a change of control, triggering event each Issuer will be required to offer to repurchase all outstanding New Senior Secured Notes or New Senior Notes, as applicable, at a purchase price in cash equal to 101% of the principal amount thereof on the date of purchase plus accrued and unpaid interest to the date of purchase. If a change of control triggering event were to occur, we cannot assure you that the Issuers would have sufficient funds available at such time to pay the purchase price of the outstanding New Notes or that the restrictions in our credit facilities or other then existing contractual obligations of the Issuers would allow the Issuers to make such required repurchases. The repurchase of the New Notes pursuant to such an offer could cause a default under such indebtedness, even if the change of control triggering event itself does not. The Issuers’ ability to pay cash to the holders of the New Notes following the occurrence of a change of control triggering event may be limited by our then existing financial resources. Sufficient funds may not be available when necessary to make any required repurchases. If an event constituting a change of control triggering event occurs at a time when the Issuers are prohibited from repurchasing New Notes or we are prohibited from satisfying our obligations under the New AH Proceeds Loans or the Senior Secured Notes Issuer is prohibited from satisfying its obligations under the New Senior Notes Proceeds Loans, we may seek the consent of the lenders under such indebtedness to the purchase of New Notes or may attempt to refinance the borrowings that contain such prohibition. If we do not obtain such consent or repay such borrowings, the Issuers will remain prohibited from repurchasing any tendered New Notes. In addition, we expect that we would require third party financing to make an offer to repurchase the New Notes upon a change of control triggering event. We cannot assure you that we would be able to obtain such financing. Any failure by the Issuers to offer to purchase New Senior Secured Notes or New Senior Notes, as applicable, would constitute a default under the applicable New Indenture, which could, in turn, constitute a default under other agreements governing our debt. See *“Description of Senior Secured Notes—Change of Control”* and *“Description of Senior Notes—Change of Control”*.

The change of control triggering event provisions contained in the New Indentures may not necessarily afford you protection in the event of certain important corporate events, including reorganizations, restructurings, mergers, recapitalizations or other similar transaction involving us that may adversely affect you, because such corporate events may not involve a shift in voting power or beneficial ownership or, even if they do, may not constitute a “change of control triggering event” as defined in the New Indentures. Except as described under *“Description of Senior Secured Notes—Change of Control”* and *“Description of Senior Notes—Change of Control”*, the New Indentures do not contain provisions that require us to offer to repurchase or redeem the New Notes in the event of a reorganization, restructuring, merger, recapitalization or similar transaction.

The definition of “change of control” contained in the New Indentures include a disposition of all or substantially all of the assets of Altice International and its restricted subsidiaries taken as whole to any person. Although there is a limited body of case law interpreting the phrase “all or substantially all,” there is no precise established definition of the phrase under applicable law. Accordingly, in certain circumstances there may be a degree of uncertainty as to whether a particular transaction would involve a disposition of “all or substantially all” of the assets of Altice International and its restricted subsidiaries taken as a whole. As a result, it may be unclear as to whether a change of control has occurred and whether the Issuers are required to make an offer to repurchase the New Notes.

We cannot assure you that an active trading market will develop for the New Notes, in which case your ability to sell the New Notes will be limited.

The New Notes will be new securities for which there is no market. We cannot assure you as to:

- the liquidity of any market that may develop for the New Notes;
- your ability to sell your New Notes; or
- the prices at which you would be able to sell your New Notes.

Future trading prices of the New Notes will depend on many factors, including, among other things, prevailing interest rates, our operating results and the market for similar securities. Historically, the market for non-investment grade securities has been subject to disruptions that have caused substantial volatility in the prices of securities similar to the New Notes. The liquidity of a trading market for the New Notes may be adversely affected by a general decline in the market for similar securities and is subject to disruptions that may cause volatility in prices. It is possible that the market for the New Notes will be subject to disruptions. Any such disruption may have a negative effect on you, as a holder of the New Notes, regardless of our prospects and financial performance. The Initial Purchasers of the New Notes have advised the Issuers that they currently intend to make a market in the New Notes. However, the Initial Purchasers are not obliged to do so, and they may discontinue any market making activities at any time without notice. As a result, there is no assurance that an active trading market will develop for the New Notes. If no active trading market develops, you may not be able to resell your New Notes at a fair value, if at all.

The New Notes may not become, or remain, listed on the Official List of the Luxembourg Stock Exchange.

Although the Issuers agree in the New Indentures to use commercially reasonable efforts to have the New Notes listed and admitted to trading on the Euro MTF Market of the Luxembourg Stock Exchange within a reasonable period after the respective issue date of the New Notes and to maintain such listing as long as the New Notes are outstanding, the Issuers cannot assure you that the New Notes will become or remain listed. If the Issuers are unable or can no longer maintain the listing on the Luxembourg Stock Exchange or it becomes unduly burdensome to make or maintain such listing (for the avoidance of doubt, preparation of financial statements in accordance with IFRS or any other accounting standard other than the accounting standard pursuant to which the Issuers prepare their financial statements shall be deemed unduly burdensome), the Issuers may cease to make or maintain such listing on the Luxembourg Stock Exchange, provided that they will use reasonable best efforts to obtain and maintain the listing of the New Notes on another stock exchange, although there can be no assurance that the Issuers will be able to do so. Although no assurance is made as to the liquidity of the New Notes as a result of listing on the Luxembourg Stock Exchange or another recognized listing exchange for high yield issuers in accordance with the New Indentures, failure to be approved for listing or the delisting of the New Notes from the Luxembourg Stock Exchange or another listing exchange in accordance with the New Indentures may have a material adverse effect on a holder's ability to resell New Notes in the secondary market.

Credit ratings may not reflect all risks.

The credit ratings assigned to the New Notes are an assessment by the relevant rating agencies of the relevant Issuer's ability to pay its debts when due, which is, in respect of payment obligations under the New Notes, dependent upon the ability of the obligors under the New AH Proceeds Loans and the New Senior Notes Proceeds Loan to make payments to pay their debts when due. Consequently, real or anticipated changes in our or the New Notes' credit ratings may generally affect the market value of the New Notes. Ratings may not reflect the potential impact of all risks relating to structure, market and additional factors discussed in these Listing Particulars, and other factors not discussed herein may affect the value of the New Notes. A credit rating is not a recommendation to buy, sell or hold securities and may be revised or withdrawn by the rating agency at any time. An explanation of the significance of such rating may be obtained from the applicable rating agency. There is no assurance that such credit ratings will be issued or remain in effect for any given period of time or that such ratings will not be lowered, suspended or withdrawn entirely by the rating agencies, if, in the applicable rating agency's judgment, circumstances so warrant. It is also possible that such ratings may be lowered in connection with the application of the proceeds of this offering or in connection with future events, such as future acquisitions. Holders of New Notes will have no recourse against us or any other parties in the event of a change in or suspension or withdrawal of such ratings. Any lowering, suspension or withdrawal of such ratings may have an adverse effect on the market price or marketability of the New Notes.

Certain covenants may be suspended upon the occurrence of a change in our ratings.

The New Indentures provide that, if at any time following the date of the New Indentures, the New Notes are rated Baa3 or better by Moody's and BBB- or better from Standard & Poors and no default or event of default has occurred and is continuing, then beginning that day the following provisions of the New Indentures will not apply to the New Notes: "—Limitation on Indebtedness", "—Limitation on Restricted Payments", "—Limitation on Restrictions on Distributions from Restricted Subsidiaries", "—Limitation on Sales of Assets and Subsidiary Stock", "—Limitation on Affiliate Transactions" and "—Impairment of Security Interests" and the provisions of clause (3) of the paragraph of the covenant described under "—Merger and Consolidation—Altice International". Notwithstanding the foregoing, if the rating assigned by any such rating agency to such New Notes should subsequently decline to below Baa3 or BBB-, respectively, the foregoing covenants will be reinstated as at and from the date of such rating decline.

If these covenants were to be suspended, we would be able to incur additional debt or make payments, including dividends or investments, which may conflict with the interests of holders of the New Notes. There can be no assurance that the New Notes will ever achieve an investment grade rating or that any such rating will be maintained.

Each Issuer is incorporated under and subject to Luxembourg law, and Luxembourg insolvency laws may not be as favorable as insolvency laws in other jurisdictions.

Each Issuer is a public limited liability company (*société anonyme*) incorporated under the laws of Luxembourg and has its center of main interests in Luxembourg. Accordingly, insolvency proceedings with respect to an Issuer may proceed under, and be governed by, Luxembourg insolvency laws. The rights of holders of New Notes and the responsibilities of the Issuers to the holders of New Notes under Luxembourg law may be materially different from those with regard to equivalent instruments under the laws of the jurisdiction in which the New Notes are offered. Additionally, the insolvency laws of Luxembourg may not be as favorable to holders of New Notes as insolvency laws of jurisdictions with which investors may be familiar.

The following is a brief description of certain aspects of insolvency laws in Luxembourg. Under Luxembourg insolvency laws, the following types of proceedings (together referred to as insolvency proceedings) may be opened against an Issuer to the extent that an Issuer has its registered office or center of main interest in Luxembourg:

- bankruptcy proceedings (*faillite*), the opening of which may be requested by an Issuer, by any of its creditors or by the Luxembourg public prosecutor. Following such a request, the courts having jurisdiction may open bankruptcy proceedings, if an Issuer (a) is in default of payment (*cessation de paiements*) and (b) has lost its commercial creditworthiness (*ébranlement de crédit*). If a court considers that these conditions are met, it may open bankruptcy proceedings, absent a request made by an Issuer or a creditor. The main effect of such proceedings is the suspension of all measures of enforcement against an Issuer except, subject to certain limited exceptions, for secured creditors, and the payment of creditors in accordance with their rank upon the realization of assets;
- controlled management proceedings (*gestion contrôlée*), the opening of which may only be requested by the Issuers and not by its creditors; and
- composition proceedings (*concordat préventif de la faillite*), the opening of which may only be requested by an Issuer (having received prior consent of a majority of its creditors) and not by its creditors. The court's decision to admit a company to the composition proceedings triggers a provisional stay on enforcement of claims by unsecured creditors.

In addition to these proceedings, the ability of the holders of New Notes to receive payment on the New Notes, as applicable may be affected by a decision of a court to grant a reprieve from payments (*sursis de paiements*) or to put an Issuer into judicial liquidation (*liquidation judiciaire*). Judicial liquidation proceedings may be opened at the request of the public prosecutor against companies pursuing an activity violating criminal laws or that are in serious violation of the commercial code or of the Luxembourg law dated August 10, 1915 on commercial companies, as amended. The management of such liquidation proceedings will generally follow similar rules as those applicable to bankruptcy proceedings.

An Issuer's liabilities in respect of the New Notes, as applicable will, in the event of a liquidation of an Issuer following bankruptcy or judicial liquidation proceedings, rank after the cost of liquidation (including any debt incurred for the purpose of such liquidation) and those of the concerned Issuer's debts that are entitled to priority under Luxembourg law. Preferential debts under Luxembourg law for instance include, among others:

- certain amounts owed to the Luxembourg Revenue;
- value added tax and other taxes and duties owed to the Luxembourg Customs and Excise;
- social security contributions; and
- remuneration owed to employees.

Assets over which a security interest has been granted will in principle not be available for distribution to unsecured creditors (except after enforcement and to the extent a surplus is realized).

During insolvency proceedings, all enforcement measures by unsecured creditors are suspended. The ability of secured creditors to enforce their security interest may also be limited in the event of controlled management proceedings automatically causing the rights of secured creditors to be frozen until a final decision has been taken by the court as to the petition for controlled management, and may be affected thereafter by a reorganization order given by the court. A reorganization order requires the prior approval by more than 50% of the creditors representing more than 50% of the Issuers' liabilities in order to take effect.

The Luxembourg act dated August 5, 2005 concerning financial collateral arrangements, as amended (the “Collateral Act 2005”) expressly provides that all financial collateral arrangements (including pledges) including enforcement measures are valid and enforceable even if entered into during the pre bankruptcy period, against all third parties including supervisors, receivers, liquidators and any other similar persons or bodies irrespective of any bankruptcy, liquidation or other situation, national or foreign, of composition with creditors or reorganization affecting anyone of the parties, save in the case of fraud.

Generally, Luxembourg insolvency laws may also affect transactions entered into or payments made by the Issuers during the pre bankruptcy hardening period (*période suspecte*) which is a maximum of six months and the 10 days preceding the judgment declaring bankruptcy, except that in certain specific situations the court may set the start of the suspect period at an earlier date. In particular:

- pursuant to article 445 of the Luxembourg code of commerce, some specific transactions (in particular, the granting of a security interest for antecedent debts, save in respect of financial collateral arrangements within the meaning of the Collateral Act 2005; the payment of debts which have not fallen due, whether payment is made in cash or by way of assignment, sale, set off or by any other means; the payment of debts which have fallen due by any means other than in cash or by bill of exchange; the sale of assets without consideration or with substantially inadequate consideration) entered into during the suspect period (or the ten days preceding it) must be set aside or declared null and void, if so requested by the insolvency receiver;
- pursuant to article 446 of the Luxembourg code of commerce payments made for matured debts as well as other transactions concluded for consideration during the suspect period are subject to cancellation by the court upon proceedings instituted by the insolvency receiver if they were concluded with the knowledge of the bankrupt’s cessation of payments;
- pursuant to article 21 (2) of the Collateral Act 2005 concerning financial collateral arrangements, notwithstanding the suspect period as referred to in articles 445 and 446 of the Luxembourg code of commerce, where a financial collateral arrangement has been entered into on the date of the commencement of a reorganization measure or winding up proceedings, but after the opening of liquidation proceedings or the coming into force of reorganization measures or the entry into force of such measures, that agreement is enforceable and binding against third parties, administrators, insolvency receivers, liquidators and other similar organs if the collateral taker proves that it ignored the fact that such proceedings had been opened or that such measures had been taken or that it could not reasonably be aware of it; and
- pursuant to article 448 of the Luxembourg code of commerce and article 1167 of the civil code (*action paulienne*) gives the insolvency receiver (acting on behalf of the creditors) has the right to challenge any fraudulent payments and transactions, including the granting of security with an intent to defraud, made prior to the bankruptcy, without any time limit.

In principle, a bankruptcy order rendered by a Luxembourg court does not result in automatic termination of contracts except for *intuitu personae* contracts, that is, contracts for which the identity of the company or its solvency were crucial. The contracts, therefore, subsist after the bankruptcy order. However, the insolvency receiver may choose to terminate certain contracts. However, as of the date of adjudication of bankruptcy, no interest on any unsecured claim will accrue vis à vis the bankruptcy estate. The bankruptcy order provides for a period of time during which creditors must file their claims with the clerk’s office of the Luxembourg district court sitting in commercial matters. After having converted all available assets of the company into cash and after having determined all the company’s liabilities, the insolvency receiver will distribute the proceeds of the sale, on a pro rata basis, to the creditors after deduction of the receiver fees and the bankruptcy administration costs.

Rights of holders of New Notes to enforce, secure and realize their rights under the Collateral may be adversely affected in Israeli insolvency proceedings.

The ability of the holders of New Notes to enforce, secure and realize their rights under the Collateral may be delayed, restricted, subordinated, completely terminated or otherwise adversely affected in any insolvency proceedings conducted under Israeli jurisdiction or subject to Israeli law. Israeli insolvency law generally favors the continuation of a business over immediate payment of creditors. The following factors, among others, may adversely affect rights of secured creditors generally and in insolvency proceedings particularly:

- Fraudulent conveyance principles and other similar laws affecting creditors’ rights and remedies generally and by application by a competent court of equitable principles. Under Israeli law, any transfer of asset or creation of a security interest by a debtor may be declared not enforceable in liquidation, reorganization or composition proceedings of the debtor if, generally, the following conditions are met: (a) the debtor is deemed insolvent (as defined in and construed under Israeli law principles) at the time of the conveyance; (b) the conveyance is effected in

the three months prior to the commencement of the liquidation or reorganization proceedings; and (c) the conveyance is made by the debtor with the intention of fraudulently preferring a certain creditor or as a result of illegal coercion or persuasion by the creditor. A specific fraudulent conveyance rule applies to security interests created under a floating charge. Under Israeli law, a floating charge created during the six months prior to the start of the liquidation, reorganization or composition proceedings, may be construed as invalid as to the indebtedness secured thereunder and not advanced by the creditor holding the floating charge at the creation of the pledge or immediately thereafter (together with interest at the rate set by law), unless sufficient proof exists to support the fact that the debtor was solvent immediately following the creation of the floating charge.

- The issuance of a liquidation order by a court of competent authority in respect of a company results in a stay of proceedings. Upon the issuance of the liquidation order, creditors of a company are prohibited from taking any action against the company or its assets to secure or realize their rights, and any such proceedings not completed are stayed. However, the liquidation order does not prevent creditors holding a secured interest from enforcing and realizing their collateral or to otherwise use it in a different manner (although the enforcement process may be procedurally limited in a certain manner). Notwithstanding the foregoing, a court of competent authority may order a moratorium on proceedings against a company for a period of up to nine months (and may extend that period for additional three month periods (without limitation as to the aggregate time frame), for special reasons) if the court is convinced that the moratorium may contribute to the formation of a compromise or arrangement between the company, its shareholders and its creditors. Secured creditors are restricted from enforcing their collateral during the moratorium period, unless the court is convinced that either (i) no adequate protection exists to safeguard the secured creditors' rights or (ii) enforcement of the secured creditor's rights will not jeopardize the ability of the company to duly form and approve the arrangement or compromise so contemplated.
- Claims and rights of creditors of a company in insolvency proceedings may abate in whole or in part due to insufficient funds and assets of the company in insolvency. Generally, the distribution of assets in insolvency proceedings is governed by two core principles: the principle of absolute superiority, according to which creditors of a certain class, who rank higher in priority to other creditors, will be permitted to satisfy their interests in full prior to creditors of a different class, who rank lower in priority, and the principle of absolute equality, according to which creditors of the same class will have a pro rata right to secure and satisfy their interest with other creditors of the same class. Generally, subject to certain exceptions, creditors holding a fixed pledge or charge rank higher in priority to shareholders and other unsecured creditors of a company and may, subject to the limitations described above, proceed in enforcing their security interest without interference. Such creditors are entitled to use the proceeds received in connection with the realization of their security interest to satisfy their entire claim but will be treated as unsecured creditors with respect to any portion of their claim not entirely satisfied by the proceeds so received if such proceeds are insufficient to repay their entire interest. Creditors holding a fixed pledge or charge may, however, be subordinated to (i) certain creditors statutorily preferred under Israeli law (e.g. tax authorities holding a tax lien in respect of taxes owed and not paid on real estate property of the company); (ii) certain creditors holding a statutory lien; and (iii) creditors holding a fixed pledge or charge over specific assets which were acquired or received by the company using debt advanced by such creditors.

The powers of the court under Israeli insolvency laws have been exercised broadly to protect a restructuring entity from actions taken by creditors and other parties and to approve various payments to be made by the restructuring entity and various arrangements with specific creditors or classes of creditors. Accordingly, following commencement of or during such proceeding, we cannot predict if payments under the New Notes would be made, whether or when the holders of New Notes, the Trustee or the Security Agent could exercise their respective rights under the New Indentures and the documents governing the Collateral or whether and to what extent holders of New Notes would be compensated for any delays in payment, if any, of principal, interest and cost, including the fees and disbursements of the Trustee.

Furthermore, based on an amendment to the Israeli Companies Law which became effective in January 2013, the following additional factors may adversely affect rights of secured creditors:

- without approval of creditors, a company will be permitted to use an asset which is subject to a charge, including selling the asset free of liens (in the ordinary course of business with either the agreement of the creditor or court approval, and not in the ordinary course of business if approved by the court) if necessary for the reorganization of the company. The secured creditor must have "adequate protection", either from the proceeds of the sale or an asset acquired to replace the asset subject to the disposition. If the asset which is subject to a security interest is sold, the proceeds of sale or any replacement asset which can be identified or traced will be subject to a corresponding security interest in favor of the secured creditor.
- without approval of creditors, the company will be able to raise new financing for the continued operations of the company subject to a stay order issued by a court. This new financing is treated as an expense of the reorganization, and is therefore given priority over other liabilities of the company. In such a financing, the company may create a charge in favor of the lenders that would have priority to the existing security interests if the court believes it

necessary for the company to raise the funds. The court would need to be satisfied that there is “adequate protection” for the existing secured creditors notwithstanding the creation of the new security interest. See “*Limitation on Validity and Enforceability of the Guarantees and the Security Interests—Israel*”.

Similarly, in the event that rehabilitation or restructuring is not sought or does not succeed, the rights of the holders of the New Notes and the Trustee to enforce remedies are likely to be sufficiently impaired by bankruptcy, receivership or other liquidation proceedings under applicable Israeli laws such as the Bankruptcy Ordinance (New Version)—1980 and the Companies Ordinance (New Version)—1983, if the benefit of such laws is sought.

It may be difficult to enforce civil liabilities or judgments against Dominican companies or its directors and executive officers outside the Dominican Republic.

Tricom and ODO are organized under the laws of the Dominican Republic and substantially all of their respective assets are located in the Dominican Republic. As a result, it may not be possible for a noteholder to enforce outside the Dominican Republic judgments against Tricom or ODO.

The Dominican Republic is not party to any treaties providing for reciprocal recognition and enforcement of judgments rendered in judicial proceedings with respect to civil and commercial matters. For a foreign judgment to be effective and enforceable in the Dominican Republic, a request for exequatur (a judgment issued by a Dominican court validating a foreign judicial decision) must be presented before the Court of First Instance (Juzgado de Primera Instancia) of the Dominican Republic. The Court of First Instance will examine the foreign judicial decision to determine whether to ratify or deny its execution under Dominican law. If exequatur is granted, the judgment issued by the foreign court will be enforceable in the Dominican Republic. In a judicial process seeking exequatur to enforce a foreign judgment the Dominican Courts examination of the matter should be limited to procedural issues such as jurisdiction, due service of process, adherence to public policy rules and enforcement matters. In practice, however, Dominican Courts have substantial discretion and may revisit the merits of the case, if deemed necessary. Procedures for obtaining an exequatur could be lengthy.

With respect to the recognition and enforcement of decisions rendered in arbitration proceedings, the Dominican Republic is party to the 1958 New York Convention on Recognition and Enforcement of Foreign Arbitral Awards (the “New York Convention”) since 2002, without reservation. Dominican Law No. 489 08 on Commercial Arbitration (Ley No. 498 08 sobre Arbitraje Comercial) sets forth the process to obtain an exequatur for a foreign arbitral award, as an ex parte process in which the petitioner is required to file a motion requesting the exequatur (along with an original, duly legalized and certified counterpart of the award and the arbitration clause or agreement to arbitrate). The Civil and Commercial Court of First Instance of the National District (Cámara Civil y Comercial del Juzgado de Primera Instancia del Distrito Nacional) has exclusive jurisdiction to grant exequatur for foreign arbitral awards. The grounds for a judge to deny an exequatur are the same as the ones provided for in the New York Convention. The decision granting an exequatur to a foreign arbitral award can be challenged through an annulment claim on the grounds specifically provided in the law (which are the same grounds as those established in the New York Convention). There are precedents of exequaturs granted to foreign arbitral awards based on the New York Convention as well as under the Law No. 489 08 on Commercial Arbitration. There are also precedents from the Court of Appeals and the Supreme Court of Justice (Suprema Corte de Justicia) of the Dominican Republic on matters relating to annulment claims filed against decisions granting exequatur to foreign arbitral awards. Although Dominican courts typically validate foreign judicial decisions and arbitral awards that do not conflict with the public policy of the Dominican Republic, there is no assurance that the Court of First Instance will render a decision ratifying any such foreign judgment or arbitral award.

On the other hand, as a matter of public policy, the property of the Dominican State cannot be subject to seizure or foreclosure for repayment of obligations incurred during the course of operating or using such property. This policy cannot be waived by the Dominican government. Therefore, even if an arbitral award or legal decision were rendered against the Dominican government and validated in that country, such judgment may not be enforced against the property of the Dominican State. However, the Supreme Court of Justice of the Dominican Republic has stated that, under certain circumstances, the principle of non seizure of the State’s property (or immunity from seizure) may not be applicable, particularly if the “public entity” to which property has been seized and/or enforcement is being sought, is a concessionaire of the Dominican government, as opposed to the Dominican government itself, and has been incorporated as a commercial entity to perform commercial and industrial activities on its own.

The Dominican State is the owner of the radioelectric spectrum. Under the rule of non seizure of State property such frequencies (or the right to use the same) may not be seized by a creditor. However, General Telecommunications Law No. 153 98 provides that concession and license rights may be pledged as security on the condition that a prior authorization from Indotel is obtained.

It may be difficult to enforce civil liabilities or judgments against Portuguese companies or its directors and executive officers outside of Portugal.

The assets of the Portuguese companies or its directors may be substantially located in Portugal. As a result, it may not be possible for a holder of the New Notes to enforce judgements against Portuguese companies or its directors outside of Portugal.

However, a judgment given in a European Union country will, in principle, be recognised in the other European Union countries without any special procedure pursuant to Council Regulation (EC) No 44/2001 of December 22, 2000, on jurisdiction and the recognition and enforcement of judgments in civil and commercial matters. Notwithstanding, judgments of European Union countries will not be recognized in other European Union countries if: (i) such recognition is manifestly contrary to public policy in the European Union country in which recognition is sought; (ii) the defendant was not served with the document that instituted the proceedings in sufficient time and in such a way as to enable the defendant to arrange for his/her defence; (iii) it is irreconcilable with a judgment given in a dispute between the same parties in the European Union country in which recognition is sought; (iv) it is irreconcilable with an earlier judgment given in another European Union or non-European Union country involving the same cause of action and the same parties.

As regards to enforceability, the judgments of European Union countries shall be enforceable in Portugal if the interested party requests a declaration of enforceability (“*exequatur*”) and it has been declared enforceable there, pursuant to article 38 of Council Regulation (EC) No 44/2001 of December 22, 2000, on jurisdiction and the recognition and enforcement of judgments in civil and commercial matters.

Nevertheless, Council Regulation (EC) No 44/2001 of December 22, 2000, on jurisdiction and the recognition and enforcement of judgments in civil and commercial matters is not applicable to the following matters: (i) the status or legal capacity of natural persons, matrimonial matters, wills and succession; (ii) bankruptcy; (iii) social security; and (iv) arbitration.

Moreover, after January 10, 2015, the Council Regulation (EC) No 44/2001 of December 22, 2000, on jurisdiction and the recognition and enforcement of judgments in civil and commercial matters will be repealed by Regulation (EU) No. 1215/2012 of the European Parliament and of the Council of December 12, 2012, on jurisdiction and the recognition and enforcement of judgments in civil and commercial matters.

According to this new Regulation (EU) No. 1215/2012 of the European Parliament and of the Council, the judgments duly obtained in European Union countries shall continue to be enforceable in Portugal without re-examination of the merits, subject to the relevant provisions of this new Regulation. However, pursuant to this new Regulation, the judgments duly obtained in European Union countries shall, in principle, be directly enforceable in Portugal without the need to request a declaration of enforceability (“*exequatur*”), as per article 39 of this new Regulation.

Concerning foreign judgments duly obtained outside the European Union, these judgments will be enforceable in Portugal after being reviewed and authorised (*exequatur*) by a Portuguese court in accordance with article 978 of the Portuguese Civil Procedure Code. According to article 979 of the said Code, the Portuguese court competent to review and authorise (*exequatur*) the judgment is the Tribunal da Relação (court of appeal) of the judicial district where the person against whom the judgment will be enforced is domiciled. Pursuant to articles 703, 980 and others of the Portuguese Civil Procedure Code, in order for the judgment to be authorised: (i) there must be no doubts regarding the authenticity of the document containing the judgment or about the intelligibility of the judgment; (ii) the matter at issue must be *res judicata* according to the laws of the country that rendered the judgment; (iii) the competence of the court was not claimed fraudulently and that the case submitted did not fall under the exclusive competence of the Portuguese courts; (iv) the exceptions of *lis pendens* and *res judicata* cannot be alleged on the grounds that there is a case pending before a Portuguese court unless the foreign court prevented jurisdiction; (v) the defendant must have been duly notified of the legal action in accordance with the laws of the country where the judgment was rendered, and in the proceedings the principles that the parties have a right to equal treatment and to contest claims were complied with; and (vi) the outcome of the judgment rendered cannot be manifestly incompatible with the international public policy of Portugal.

With respect to the recognition and enforcement of decisions rendered in arbitration proceedings, Portugal is party to the 1958 New York Convention on Recognition and Enforcement of Foreign Arbitral Awards (the “*New York Convention*”), without reservation.

Moreover, Portuguese Law No. 63/2011 on Arbitration sets forth the process to obtain an *exequatur* for a foreign arbitral award, in which the petitioner is required to file a motion requesting the *exequatur* (along with an original, duly legalized and certified counterpart of the award and the arbitration clause or agreement to arbitrate). The grounds for a judge to deny an *exequatur* are set forth in article 56 of the Portuguese Arbitration Law.

Transfers of the New Notes are restricted, which may adversely affect the value of the New Notes.

The New Notes are being offered and sold pursuant to an exemption from registration under the U.S. Securities Act and applicable state securities laws of the United States. The New Notes have not been, and will not be, registered under the U.S. Securities Act or any U.S. state securities laws. Therefore, you may not transfer or sell the New Notes in the United States except pursuant to an exemption from, or a transaction not subject to, the registration requirements of the U.S. Securities Act and applicable state securities laws, or pursuant to an effective registration statement, and you may be required to bear the risk of your investment in the New Notes for an indefinite period of time. The New Notes and the New Indentures contain provisions that restrict the New Notes from being offered, sold or otherwise transferred except pursuant to the exemptions available pursuant to Rule 144A and Regulation S under the U.S. Securities Act, or other exemptions under the U.S. Securities Act. In addition, by acceptance of delivery of any New Notes, the holder thereof agrees on its own behalf and on behalf of any investor accounts for which it has purchased the New Notes that it shall not transfer the New Notes, as applicable, in an aggregate principal amount of less than \$200,000 in the case of the dollar-denominated New Notes or €100,000 in the case of the euro-denominated New Notes. Furthermore, the Issuers have not registered the New Notes under any other country's securities laws. It is your obligation to ensure that your offers and sales of the New Notes within the United States and other countries comply with applicable securities laws. See "*Transfer Restrictions*".

You may be unable to recover in civil proceedings for U.S. securities laws violations.

Each of the Issuers is incorporated under the laws of Luxembourg and the Guarantors are organized under the laws of Portugal, Luxembourg, Israel, Switzerland, the Bahamas and the Dominican Republic. It is anticipated that some or all of the directors and executive officers of the Issuers and Guarantors will be non residents of the United States and that all or a majority of their assets will be located outside the United States. As a result, it may not be possible for investors to effect service of process within the United States upon the Issuers, the Guarantors or their respective directors and executive officers, or to enforce any judgments obtained in U.S. courts predicated upon civil liability provisions of the U.S. securities laws. Additionally, there is doubt as to the enforceability in many foreign jurisdictions of civil liabilities based on the civil liability provisions of the federal or state securities laws of the United States against ourselves, the Guarantors, the directors, controlling persons and management and any experts named in these Listing Particulars who are not residents of the United States. See "*Enforcement of Judgments*".

You may face currency exchange risks or adverse tax consequences by investing in the New Notes denominated in currencies other than your reference currency.

The New Notes are denominated and payable in U.S. dollar and euro. If you are a sterling or other non U.S. dollar or non-euro investor, an investment in the New Notes will entail foreign exchange related risks due to, among other factors, possible significant changes in the value of the U.S. dollar or euro relative to sterling, euro or other relevant currencies because of economic, political or other factors over which we have no control. Depreciation of the U.S. dollar or euro against sterling, the euro or other relevant currencies could cause a decrease in the effective yield of the New Notes below their stated coupon rates and could result in a loss to you when the return on the New Notes is translated into the currency by reference to which you measure the return on your investments. Investments in the New Notes by U.S. investors may also have important tax consequences as a result of foreign currency exchange gains or losses, if any. See "*Tax considerations—Certain U.S. federal income tax considerations*".

The New Notes will initially be held in book entry form, and therefore you must rely on the procedures of the relevant clearing systems to exercise any rights and remedies.

Owners of the book entry interests will not be considered owners or holders of the New Notes unless and until New Notes in registered definitive form ("Definitive Notes") are issued in exchange for book entry interests. Instead, the common depository for Euroclear, Clearstream and/or DTC (or their nominee) will be the sole holder of the global notes representing the New Notes.

Payments of principal, interest and other amounts owing on or in respect of the New Notes in global form will be made to the Principal Paying Agent, which will make payments to Euroclear, Clearstream and/or DTC, as applicable. Thereafter, such payments will be credited to Euroclear, Clearstream and/or DTC participants' accounts that hold book entry interests in the New Notes, as applicable, in global form and credited by such participants to indirect participants. After payment to Euroclear, Clearstream and/or DTC, none of us, the Trustee, the transfer agent, the Registrars or any Paying Agent will have any responsibility or liability for any aspect of the records relating to or payments of interest, principal or other amounts to Euroclear, Clearstream and/or DTC or to owners of book entry interests.

Owners of book entry interests will not have the direct right to act upon our solicitations for consents or requests for waivers or other actions from holders of the New Notes, including enforcement of security for the New Notes. Instead, if you own a book entry interest, you will be permitted to act directly only to the extent you have received appropriate

proxies to do so from Euroclear, Clearstream and/or DTC or, if applicable, from a participant. We cannot assure you that procedures implemented for the granting of such proxies will be sufficient to enable you to vote on any requested actions or to take any other action on a timely basis. See “*Book Entry, Delivery and Form*”.

Risks relating to the Transactions

The PT Portugal Acquisition is subject to significant uncertainties and risks.

The consummation of the PT Portugal Acquisition is subject to the conditions set out in the PT Portugal Acquisition Agreement, including regulatory approval in Portugal and from the European Commission. Furthermore, in the case that the regulator requires any concessions from us to approve the PT Portugal Acquisition, we may have to dispose of some or all of our existing Portuguese assets, including Cabovisao and/or ONI as of September 30, 2014, Cabovisao and ONI had assets of over €170 million and generated revenues of €190.1 million and EBITDA of €57.4 million for the LTM ended September 30, 2014. There can be no assurance that such approvals will be obtained in a timely manner if at all. See “*The Transactions*”.

The completion of the PT Portugal Acquisition may be subject to litigation that if realized may result in a material adverse effect on, including delay in completion of, the PT Portugal Acquisition.

The PT Portugal Acquisition has received extensive coverage in the press in Brazil and Portugal, including with respect to statements made and positions taken by Portugal Telecom SGPS, S.A., the Portuguese Securities Market Commission and other parties relating to certain aspects of the PT Portugal Acquisition. The PT Portugal Acquisition may be subject to litigation risks that are frequently faced by parties in connection with transactions of this type, including challenges by dissenting shareholders, and at least one civil action has been filed by shareholders against Portugal Telecom SGPS, S.A. challenging the extraordinary general meeting in which the sale of PT Portugal was approved. Plaintiffs in any such litigation action may seek, among other remedies, compensatory damages (which may involve claims for a significant amount of monetary damages) or injunctive relief (which, if granted, may delay the closing the PT Portugal Acquisition, including beyond the Escrow Longstop Date). The outcome of any such suit is inherently uncertain. As a result, we cannot assure you that any such litigation will not result in payment of settlement amounts, award of monetary damages against the relevant parties to any such lawsuit or grant of other remedies, including injunctions, any one of which may be material in amount and/or impact on the completion of the PT Portugal Acquisition and may have a material adverse effect on the combined Group’s business, financial condition or results of operations.

Anticipated synergies from the PT Portugal Acquisition may not materialize.

Upon completion of the PT Portugal Acquisition, we expect to achieve certain synergies discussed elsewhere in these Listing Particulars relating to the operations of the PT Portugal Group as it will become part of the Group and become consolidated subsidiaries of Altice International. We may not realize any or all of the anticipated synergies of the PT Portugal Acquisition that we currently anticipate, including if we are unable to consummate the PT Portugal Acquisition. Among the synergies that we currently expect are operational synergies in the following areas: telecommunication equipment procurement, content procurement, maintenance spend, customer care, IT, workflow processes, marketing and product offering. Our estimated synergies from the PT Portugal Acquisition are subject to a number of assumptions about the timing, execution and costs associated with realizing the synergies. There can be no assurance that such assumptions turn out to be correct and, as a result, the amount of synergies that we will actually realize over time may differ significantly from the ones that we currently estimate and we may also incur significant costs in integrating the PT Portugal Group. We may not be successful in integrating some or all of these businesses as currently anticipated which may have a material adverse effect on our business and operations.

The integration of the PT Portugal Group into the Group could result in operating difficulties and other adverse consequences.

The consummation of the PT Portugal Acquisition and the integration of the PT Portugal Group as anticipated into the Group may create unforeseen operating difficulties and expenditures and pose significant management, administrative and financial challenges to our business. These challenges include:

- integration of the PT Portugal Group into our current business in a cost effective manner, including network infrastructure, management information and financial control systems, marketing, branding, customer service and product offerings;
- outstanding or unforeseen legal, regulatory, contractual, labor or other issues arising from the PT Portugal Acquisition;
- integration of different company and management cultures; and

- retention, hiring and training of key personnel.

In such circumstances, our failure to effectively integrate the PT Portugal Group into our Group could have a material adverse effect on our financial condition and results of operations.

Moreover, the PT Portugal Acquisition has required, and will likely continue to require, substantial amounts of certain of our management's time and focus, which could potentially affect their ability to operate the business.

If the conditions to the escrow releases are not satisfied, the Issuers will be required to redeem some or all of the New Notes, which means that you may not obtain the return you expect on the New Notes.

Pending satisfaction of the conditions to release of the escrow proceeds, the gross proceeds of the offering of the New Senior Secured Notes are being held in the Senior Secured Notes Escrow Accounts and the gross proceeds of the offering of the New Senior Notes are being held in the Senior Notes Escrow Account on behalf of the holders of the applicable New Notes. If the conditions to the release of the escrow proceeds as described in “*Description of Senior Secured Notes—Escrow of Proceeds; Special Mandatory Redemption*” and/or “*Description of Senior Notes—Escrow of Proceeds; Special Mandatory Redemption*” are not satisfied by on or prior to June 9, 2016 or in the event of certain other events that trigger escrow termination occur, the applicable New Notes will be subject to a special mandatory redemption and you may not obtain the return you expect to receive on such New Notes. See “*Description of Senior Secured Notes—Escrow of Proceeds; Special Mandatory Redemption*” and “*Description of Senior Notes—Escrow of Proceeds; Special Mandatory Redemption*”. The Indentures require the Senior Secured Notes Issuer (in the case of the Senior Secured Notes Indenture) and the Senior Notes Issuer (in the case of the Senior Notes Indenture) to consummate the PT Portugal Acquisition promptly upon release of the proceeds from the Escrow Accounts (other than a release for purposes of investing the escrow proceeds in accordance with the Senior Secured Notes Escrow Agreement or the Senior Notes Escrow Agreement (as applicable)).

The escrow funds will be limited to the gross proceeds of the offering of the New Notes and will not be sufficient to pay the special mandatory redemption price, which is equal to 100% of the initial issue price of each of the New Notes plus accrued and unpaid interest and additional amounts, if any, from the Issue Date to the date of the special mandatory redemption.

Your decision to invest in the New Notes is made at the time of purchase. Changes in our business or financial condition or the terms of the PT Portugal Acquisition or the financing thereof, between the closing of this offering and the release of the escrow proceeds, will have no effect on your rights as a purchaser of the New Notes.

PT Portugal will not be controlled by us until completion of the PT Portugal Acquisition.

We currently do not own PT Portugal. We will not acquire PT Portugal until completion of the PT Portugal Acquisition. The PT Portugal Acquisition is expected to be consummated in the second quarter of 2015, subject to regulatory approval in Portugal and merger-control clearance from the European Commission (or from the Portuguese Competition Authority, under the applicable referral rules). We cannot assure you that during the interim period the business of the PT Portugal Group will be operated in the same way that we would operate them.

The information contained in these Listing Particulars relating to the PT Portugal Group has been derived from public sources and other sources we believe to be reliable.

THE TRANSACTIONS

PT Portugal Acquisition

On December 9, 2014, Altice S.A., through its subsidiary Altice Portugal, entered into an agreement with Oi S.A. (the “PT Portugal Acquisition Agreement”) relating to the purchase of all of the outstanding equity interests in PT Portugal (the “PT Portugal Acquisition”). The total consideration for this transaction amounts to an initial purchase price of €6,900 million on a debt and cash free basis, as adjusted for estimated net post-retirement benefit obligations post tax of €957 million and other non-financial debt purchase price adjustments (including working capital adjustments and certain tax liabilities) of €339 million (price paid will be after deduction of net financial debt at closing and difference to normative level of working capital, as defined in the PT Portugal Acquisition Agreement) payable in cash upon completion of the PT Portugal Acquisition, and an earn out of €500 million, payable in the event the consolidated revenues of the PT Portugal Group for any financial year between 2015 to 2019 achieves a specified target. In order for PT Portugal to exceed such specified revenue target by the end of the specified period, its revenue growth will need to materially exceed the best-in-class compound annual revenue growth rate currently expected by the market from incumbent telecommunications companies in Europe. Prior to the Completion Date, Oi S.A. shall cause a reorganization of PT Portugal and its subsidiaries to be completed (the “Carve Out Reorganization”) so that, among other things, upon the completion of the PT Portugal Acquisition, PT Portugal shall no longer own any interests in the Asian entities and assets, African entities and assets, other than Open Ideia (Angola), Open Ideia (Morocco) and Contact Cabo Verde, or in the financing vehicles that are currently part of the PT Portugal perimeter. In particular, the commercial paper and any other securities issued by Rio Forte Investments S.A shall not be included in the assets comprising the PT Portugal Group.

The consummation of the PT Portugal Acquisition is subject to certain conditions, including merger control from the European Commission (or from the Portuguese Competition Authority, under the referral mechanism set forth in the EU merger control rules) and relevant authorizations and clearances from the Portuguese ISP (Instituto de Seguros de Portugal). The PT Portugal Acquisition Agreement provides that the parties shall cooperate in order to obtain as soon as practicable the authorizations or clearances needed to fulfil the conditions to closing and to consummate the PT Portugal Acquisition. The PT Portugal Acquisition Agreement shall terminate, and the parties will not be required to consummate the PT Portugal Acquisition, if such clearances or authorizations have not been obtained at the latest within eighteen months of December 9, 2014. In the event the conditions to completion of the PT Portugal Acquisition are satisfied and Altice Portugal fails to consummate the PT Portugal Acquisition, Altice Portugal shall be liable to pay a specified break-up fee to Oi S.A. Similarly, in the event the Carve Out Reorganization is not completed within six months of December 9, 2014, or the conditions to completion of the PT Portugal Acquisition are satisfied and Oi S.A. fails to consummate the PT Portugal Acquisition, Oi S.A. shall be liable to pay a specified break-up fee to Altice Portugal.

Under the PT Portugal Acquisition Agreement, Oi S.A. has agreed to cause PT Portugal and the entities that will comprise the PT Portugal Group to operate its business solely in the ordinary course and consistent with past practice. In addition, Oi S.A. has undertaken covenants to place certain restrictions on the ability of PT Portugal and of the entities that will comprise the PT Portugal Group to take certain actions without the prior consent of Altice Portugal (not to be withheld unreasonably) customary for that type of transaction. Failure by Oi S.A. to comply with these restrictions or with any of its covenants under the PT Portugal Acquisition Agreement, unless waived by Altice Portugal, could, under certain circumstances, result in the PT Portugal Acquisition Agreement being terminated by Altice Portugal.

The PT Portugal Acquisition Agreement also provides that Altice S.A. guarantees the fulfillment by Altice Portugal of its obligations under the PT Portugal Acquisition Agreement.

The Financing

The consideration for the PT Portugal Acquisition together with related fees and expenses are being financed as follows:

- the Senior Notes Issuer has issued the New Senior Notes;
- the Senior Secured Notes Issuer has issued the New Senior Secured Notes;
- the Senior Secured Notes Issuer has entered into the New Term Loan. The Senior Secured Notes Issuer may draw the New Term Loan on one occasion at any time (subject to compliance with certain conditions) on or prior to June 9, 2016. It is expected that the New Term Loan will be fully drawn to consummate the PT Portugal Acquisition;
- the Senior Secured Notes Issuer entered into the New Super Senior Revolving Credit Facility. It is expected that the New Super Senior Revolving Credit Facility may be fully drawn to consummate the PT Portugal Acquisition. We may utilize excess cash (to the extent available at the time of completion of the PT Portugal Acquisition) or other

debt sources in place of some or all of the funds currently expected to be drawn under the New Super Senior Revolving Credit Facility to consummate the PT Portugal Acquisition; and

- Altice S.A. issued the New ASA Senior Notes which will be contributed to the Altice International Group in the form of the ASA Notes Proceeds Contribution.

Pending satisfaction of the conditions to the release of the escrow proceeds as described in “*Description of Senior Secured Notes—Escrow of Proceeds; Special Mandatory Redemption*” and “*Description of Senior Notes—Escrow of Proceeds; Special Mandatory Redemption*”, the Initial Purchasers (i) deposited the gross proceeds from the offering of the New Senior Notes into the Senior Notes Escrow Account for the benefit of the holders of the New Senior Notes and the Trustee and (ii) deposited the gross proceeds from the offering of the New Senior Secured Notes into the Senior Notes Escrow Account for the benefit of the holders of the New Senior Secured Notes and the Trustee.

The Senior Secured Notes Escrow Accounts are controlled by the Senior Secured Notes Escrow Agent and pledged on a first ranking basis in favor of the Trustee on behalf of the holders of the Senior Secured Notes. The Senior Notes Escrow Account is controlled by and pledged on a first ranking basis in favor of the Trustee on behalf of the holders of the Senior Notes. See “*Description of Senior Secured Notes—Escrow of Proceeds; Special Mandatory Redemption*” and “*Description of Senior Notes—Escrow of Proceeds; Special Mandatory Redemption*”. The proceeds of the New Notes will be released to the Issuers upon delivery of an applicable officer’s certificate to the Escrow Agent stating that, among other things, the PT Portugal Acquisition Agreement shall not have been modified, amended or waived in any respect that is material and adverse to the holders of the Notes (subject to certain exceptions), the PT Portugal Acquisition Agreement remains in full force and effect and no insolvency related events have occurred with respect to the Senior Secured Notes Issuer (in the case of the Senior Secured Notes Escrow Agreement) and the Senior Notes Issuer (in the case of the Senior Notes Escrow Agreement). If the conditions for the release of escrow proceeds are not satisfied prior to June 9, 2016 or upon the occurrence of certain other events, the New Notes will be subject to a special mandatory redemption at 100% of the principal amount plus accrued and unpaid interest and additional amounts, if any.

The Indentures require the Senior Secured Notes Issuer (in the case of the Senior Secured Notes Indenture) and the Senior Notes Issuer (in the case of the Senior Notes Indenture) to consummate the PT Portugal Acquisition promptly upon release of the proceeds from the Escrow Accounts (other than a release for purposes of investing the escrow proceeds in accordance with the terms of the Senior Secured Notes Escrow Agreement or the Senior Notes Escrow Agreement (as applicable)).

The gross proceeds from the New ASA Senior Notes offering and the New Term Loan are also held in segregated escrow accounts pursuant to escrow agreements and the release of such proceeds will be subject to similar conditions.

The transactions referred to under “*—PT Portugal Acquisition*” and “*—The Financing*” are collectively referred to as the “New Transactions”.

USE OF PROCEEDS

Sources and Uses for the New Transactions

The expected estimated sources and uses of the funds necessary to consummate the PT Portugal Acquisition are shown in the table below. Actual amounts may vary from the estimated amounts depending on several factors, including, among other things, (i) differences in the amount of indebtedness outstanding and (ii) differences from our estimates of fees and expenses and the actual fees and expenses, as of the completion of the PT Portugal Acquisition. The completion of the PT Portugal Acquisition is subject to certain conditions, including the separate approval by the competent regulatory authorities in Portugal and merger-control clearance by the European Commission (or from the Portuguese Competition Authority, under the referral mechanism set forth in the EU merger control rules).

The amounts set forth below are based on an exchange rate as of January 29, 2015, of €0.882 = \$1.00.

	Sources of Funds		Uses of Funds		
	\$ in millions	€ in millions	\$ in millions	€ in millions	
New Term Loan ⁽¹⁾	954	841	Cash Acquisition Consideration for PT Portugal ⁽⁵⁾	6,355	5,604
New Senior Secured Notes offered hereby ⁽²⁾	2,627	2,317	Transaction Fees and Expenses ⁽⁶⁾	146	128
New Senior Notes offered hereby ⁽²⁾	385	340			
New Super Senior Revolving Credit Facilities ⁽³⁾	204	180			
New ASA Senior Notes ⁽⁴⁾	2,331	2,055			
Total Sources	6,501	5,732	Total Uses	6,501	5,732

- (1) On or around the Issue Date, the Senior Secured Notes Issuer entered into the €841 million (equivalent) New Term Loan. The Senior Secured Notes Issuer drew under the New Term Loan fully to consummate the PT Portugal Acquisition. The gross proceeds from borrowings under the New Term Loan have been deposited in segregated escrow accounts on behalf of the lenders thereunder, pending satisfaction of the conditions to the release of the escrow proceeds in accordance with the relevant escrow agreements relating thereto.
- (2) The gross proceeds from the sale of the Dollar Senior Secured Notes and the Euro Senior Secured Notes have been deposited in segregated escrow accounts on behalf of the respective holders of the New Senior Secured Notes and the gross proceeds from the sale of the New Senior Notes have been deposited in a segregated escrow account on behalf of the respective holders of the New Senior Notes, in each case, pending satisfaction of the conditions to the release of the escrow proceeds as described in “*Description of Senior Secured Notes—Escrow of Proceeds; Special Mandatory Redemption*” and “*Description of Senior Notes—Escrow of Proceeds; Special Mandatory Redemption*”. See “*The Transactions—The Financing*” for further details.
- (3) The New Revolving Credit Facilities are made up of (i) a € 330 million New Super Senior Revolving Credit Facility (which was entered into prior to the Issue Date) and (ii) a €501 million New Pari Passu Revolving Credit Facility. It is expected that €180 million under the New Super Senior Revolving Credit Facility may be drawn to consummate the PT Portugal Acquisition.
- (4) The gross proceeds from the sale of the New ASA Senior Notes have been deposited in segregated escrow accounts on behalf of the holders of the New ASA Senior Notes, pending satisfaction of the conditions to the release of the escrow proceeds in accordance with the relevant escrow agreements relating thereto. It is expected that Altice S.A. will contribute the proceeds of the New ASA Senior Notes to Altice International in exchange for mandatory convertible notes of €2,055 million aggregate value (with €100,000 nominal value each) to be issued by Altice International and to be subscribed by Altice S.A., and Altice International will, in turn, contribute such proceeds to Altice Holdings (the “ASA Notes Proceeds Contribution”).
- (5) Represents a total consideration of €6,900 million on a debt and cash free basis as adjusted for estimated net post retirement benefit obligations post tax of €957 million and other non-financial debt purchase price adjustments (including working capital adjustments and certain tax liabilities) of €339 million (price paid will be after deduction of net financial debt at closing and difference to normative level of working capital, as defined in the PT Portugal Acquisition Agreement). The cash consideration for the PT Portugal Acquisition totals €5,604 million. The total consideration and cash consideration figures exclude an earn-out of € 500 million which is payable if the revenues generated by the PT Portugal Group for any financial year between 2015 to 2019 achieve a specified target. In order for PT Portugal to exceed such specified revenue target by the end of the specified period, its revenue growth will need to materially exceed the best-in-class compound annual revenue growth rate currently expected by the market from incumbent telecommunications companies in Europe. The total enterprise value of € 7,400 million represents the sum of the cash consideration, the estimated net pension liabilities, other purchase price adjustments and the earn-out. The PT Portugal Acquisition is subject to regulatory approval by the competent regulatory authorities in Portugal and merger-control clearance by the European Commission (or from the Portuguese Competition Authority, under the referral mechanism set forth in the EU merger control rules). See “*The Transactions—PT Portugal Acquisition*” for further details.
- (6) This amount reflects our estimate of the fees and expenses we will pay in connection with the New Transactions, including commitment, placement, financial advisory and other transaction costs and professional fees. This amount may differ from the estimated amount

depending on several factors, including differences from our estimates of fees and expenses and the actual fees and expenses as of the completion of the various transactions contemplated by the New Transactions.

CAPITALIZATION

The following table presents, in each case, the cash and cash equivalents and debt capitalization as of September 30, 2014 of the Group (i) on a historical combined basis and (ii) on an as adjusted combined basis after giving effect to the New Transactions and to the repayment of the Existing Coditel Mezzanine Facility, including the offering of the New Notes hereby, the funding of the New Term Loan and the expected amounts to be drawn under the New Super Senior Revolving Credit Facility to consummate the PT Portugal Acquisition and the application of the proceeds therefrom. The as adjusted amounts are estimates and may not accurately reflect the amounts outstanding upon completion of the New Transactions. This table should be read in conjunction with “Use of Proceeds”, “Illustrative Aggregated Selected Financial Information”, “Pro Forma Financial Information”, “Description of Other Indebtedness” and the financial statements and notes thereto included elsewhere in these Listing Particulars. The completion of the PT Portugal Acquisition is subject to certain conditions, including the approval by the competent regulatory authorities in Portugal and merger-control clearance by the European Commission (or from the Portuguese Competition Authority, under the referral mechanism set forth in the EU merger control rules).

The impact of any derivative instruments that we have or may enter into to manage foreign currency risk associated with our debt (including the New Notes) has not been reflected in the as adjusted data presented in the table. Unless otherwise stated, amounts are based on the exchange rate as of September 30, 2014 of €0.7918 = \$1.00.

	September 30, 2014	
	Actual	As Adjusted
	€ in millions	
Cash and cash equivalents	141	141
Third-party debt:		
Third-party senior debt		
Existing HOT Unsecured Notes ⁽¹⁾	255	255
Existing Coditel Mezzanine Facility ⁽²⁾	116	—
Green Datacenter Debt ⁽³⁾	35	35
Finance leases (Altice International).....	22	22
Finance leases (PT Portugal).....	—	44
Existing Senior Secured Notes ⁽⁴⁾	1,587	1,587
2013 Term Loan.....	813	813
Existing Revolving Credit Facilities ⁽⁵⁾	—	124
New Term Loan ⁽⁶⁾	—	841
New Senior Secured Notes offered hereby ⁽⁷⁾	—	2,317
New Revolving Credit Facilities ⁽⁸⁾	—	180
Total third-party senior debt (excluding other liabilities) ⁽⁹⁾	2,827	6,217
Existing Senior Notes ⁽¹⁰⁾	903	903
New Senior Notes offered hereby ⁽¹¹⁾	—	340
Total third-party debt (excluding other liabilities)	3,730	7,460

(1) The amount is based on the exchange rate as of September 30, 2014 of € 0.215 = NIS1.00.

(2) The Existing Coditel Mezzanine Facility was refinanced on December 2, 2014 with proceeds from our Existing Revolving Credit Facilities.

(3) Green Datacenter is designated as an unrestricted subsidiary under the terms governing the indebtedness of the Group.

(4) Reflects the aggregate \$1,360 million and €510 million Existing Senior Secured Notes outstanding.

(5) The Senior Secured Notes Issuer may draw on the Existing Revolving Credit Facilities to support our working capital purposes. The Existing Revolving Credit Facilities are made up of (i) a \$80 million 2012 Revolving Credit Facility and (ii) a €80 million 2013 Revolving Credit Facility. The Senior Secured Notes Issuer also has access to the 2013 Guarantee Facility allowing for requests for guarantees to be issued up to a maximum of €15 million. On December 2, 2014, we drew all of the 2013 Revolving Credit Facility and \$56 million of the 2012 Revolving Credit Facility to repay the Existing Coditel Mezzanine Facility. On January 27, 2015, we repaid the \$56 million outstanding under the 2012 Revolving Credit Facility. As of the date hereof, all of the 2013 Revolving Credit Facility has been drawn. In addition, as of the date hereof, the Senior Secured Notes Issuer has made one request for a guarantee of up to approximately €6.8 million to be issued under the 2013 Guarantee Facility, which represents a contingent liability of the Group.

(6) On or around the Issue Date, the Senior Secured Notes Issuer will enter into the €841 million (equivalent) New Term Loan. It is expected that the New Term Loan will be fully drawn to consummate the PT Portugal Acquisition. To the extent drawn prior to the Completion Date, the gross proceeds from borrowings under the New Term Loan will be deposited in segregated escrow accounts on behalf of the lenders thereunder, pending satisfaction of the conditions to the release of the escrow proceeds in accordance with the relevant escrow agreements relating thereto.

(7) Reflects the issuance of the New Senior Secured Notes offered hereby. The amount is based on an exchange rate as of January 29, 2015, of €0.882 = \$1.00. Pending satisfaction of certain conditions to the release of the escrow proceeds, the gross proceeds from the sale of the New

Senior Secured Notes will be deposited in a segregated escrow account in the name of the Senior Secured Notes Escrow Agent on behalf of the respective holders of the New Senior Secured Notes. See “*The Transactions—The Financing*” and “*Use of Proceeds*”. See “*Description of Senior Secured Notes—Escrow of Proceeds; Special Mandatory Redemption*”.

- (8) The New Revolving Credit Facilities are made up of (i) a €330 million New Super Senior Revolving Credit Facility (which was entered in to on or prior to the Issue Date) and (ii) a €501 million New Pari Passu Revolving Credit Facility. It is expected that €180 million under the New Super Senior Revolving Credit Facility may be drawn to consummate the PT Portugal Acquisition.
- (9) Excludes certain other long-term and short-term liabilities, other than finance leases, of the Group, any intercompany loans among the Group and preferred equity certificates issued in connection with the Tricom Acquisition and any other preferred equity certificates issued to minority shareholders in our subsidiaries. Other long-term and short-term liabilities include, among other things, HOT’s obligations to the State of Israel related to its mobile license and its ownership of the cable network, contingent consideration on behalf of the HOT Mobile acquisition, trade payables, other payables, provision for lawsuits, accrued severance liability, and deferred tax liability.
- (10) Reflects the aggregate \$825 million and €250 million Existing Senior Notes outstanding.
- (11) Reflects the issuance of the New Senior Notes offered hereby. The amount is based on an exchange rate as of January 29, 2015, of € 0.882 = \$1.00. Pending satisfaction of certain conditions to the release of the escrow proceeds, the gross proceeds from the sale of the New Senior Notes will be deposited in a segregated escrow account in the name of the Senior Notes Escrow Agent on behalf of the respective holders of the New Senior Notes. See “*The Transactions—The Financing*” and “*Use of Proceeds*”. See “*Description of Senior Notes—Escrow of Proceeds; Special Mandatory Redemption*”.

Shareholder Funding

In connection with the Transactions, Altice International will issue €2,055 million of mandatory convertible notes to Altice S.A (the “AI Mandatory Convertible Notes”).

The AI Mandatory Convertible Notes are direct, unconditional, subordinated and unsecured obligations of Altice International and are non-transferable other than in case of enforcement of any collateral granted over it. The AI Mandatory Convertible Note will be subordinated to any Senior Debt as defined under the Intercreditor Agreement (see “*Description of Other Indebtedness—The Intercreditor Agreement*”). The proceeds of the AI Mandatory Convertible Notes will be used to finance the PT Portugal Acquisition and to pay any tax and operational expenses. The AI Mandatory Convertible Notes will bear interest at a rate corresponding to the weighted annual interest rate of the Senior Debt (as defined under an intercreditor agreement dated 8 May 2014 entered into between amongst others Altice S.A. and Deutsche Bank as security agent (the “ASA Intercreditor”) plus an arm’s length margin in accordance with OECD guidelines. The interest accrues on a semi-annual basis.

In case of an early reimbursement of the Senior Debt (as defined in the ASA Intercreditor), Altice International shall have the right (subject to notice requirements) to convert all or part of the AI Mandatory Convertible Notes into shares of Altice International (“AI Shares”) up to the amount of the early reimbursement of the Senior Debt. In addition, the AI Mandatory Convertible Notes will be automatically converted into AI Shares upon the occurrence of certain insolvency, bankruptcy or related events of Altice International. The AI Mandatory Convertible Notes cannot be converted into cash and Altice S.A. cannot demand a cash reimbursement. The conversion of AI Mandatory Convertible Notes into AI Shares will be in such amount of ordinary AI Shares whose nominal value equals the sum of the nominal value of the AI Mandatory Convertible Notes so converted. Once converted, the AI Mandatory Convertible Notes will no longer be outstanding and Altice S.A. has no rights other than of the conversion shares (which shall be fully paid up) and the payment of any interest then due and unpaid.

The AI Mandatory Convertible Notes are governed by the laws of the Grand Duchy of Luxembourg and the terms and conditions thereof may be amended or waived with the written consent of Altice International, Altice S.A. and the creditors of any Senior Debt as defined under the Intercreditor Agreement (see “*Description of Other Indebtedness—The Intercreditor Agreement*”) or their representative or agent provided that the consent of Altice S.A. and the majority creditors of any Senior Debt or their representative or agent will not be required if such amendment or waiver (a) is not materially less favourable to the creditors of the Senior Debt as determined by an independent third party or (b) is of a minor, administrative or technical nature or to correct a technical or administrative error.

PRO FORMA FINANCIAL INFORMATION OF THE GROUP

ALTICE INTERNATIONAL S.à r.l.
 UNAUDITED PRO-FORMA FINANCIAL INFORMATION
 AS OF AND FOR THE NINE MONTH PERIOD ENDED
 SEPTEMBER 30, 2014 AND SEPTEMBER 30, 2013
 AND THE YEAR ENDED DECEMBER 31, 2013

	Altice International Consolidated Financial Information	ODO (Note 3a)	ODO (Note 3a)	Refinancing of Coditel mezzanine (Note 3b)	Issuance of new debt to finance the Acquisition (Note 3b)	Altice International Pre-PT/ODO Pro forma Financial Information	PT Portugal Group (Note 3b)	Intercompany transactions (Note 3j)	Altice International Post Transaction pro forma accounts
For the nine months ended September 30, 2014	January 1, 2014 to September 30, 2014	April 9, 2014 to September 30, 2014	January 1, 2014 to September 30, 2014	January 1, 2014 to September 30, 2014	January 1, 2014 to September 30, 2014	January 1, 2014 to September 30, 2014	January 1, 2014 to September 30, 2014	January 1, 2014 to September 30, 2014	January 1, 2014 to September 30, 2014
	In Million €								
Revenue	1,372.8	(218.6)	327.4	—	—	1,481.6	1,900.9	(17.6)	3,365.0
Purchases and subcontracting services	(324.5)	48.8	(76.2)	—	—	(351.9)	(403.8)	12.8	(742.9)
Other operating expenses	(421.4)	65.3	(101.3)	—	—	(457.4)	(750.5)	4.7	(1,203.2)
Operating income before depreciation & amortisation	626.9	(104.5)	149.8	—	—	672.3	746.6	—	1,418.9
Depreciation and amortization	(397.6)	36.0	(51.3)	—	—	(412.9)	(577.6)	—	(990.4)
Management fees	(0.6)	—	—	—	—	(0.6)	—	—	(0.6)
Restructuring, non-recurring costs and other expenses	(58.5)	5.8	(8.7)	—	—	(61.4)	(22.7)	—	(84.1)
Operating profit/(loss)	170.3	(62.7)	89.9	—	—	197.4	146.3	—	343.7
Financial income	32.1	(1.7)	2.5	—	—	32.8	2.0	—	34.8
Finance costs	(334.3)	66.9	(67.2)	6.9	(248.8)	(576.5)	(243.8)	—	(820.3)
Share in income of associates	—	—	—	—	—	—	2.3	—	2.3
(Loss)/Profit before income tax expenses	(132.0)	2.5	25.1	6.9	(248.8)	(346.2)	(93.2)	—	(439.5)
Income tax (expense)/(income)	(27.6)	4.0	(12.2)	—	—	(35.8)	8.2	—	(27.6)
(Loss)/Profit for the period	(159.6)	6.5	13.0	6.9	(248.8)	(382.0)	(85.0)	—	(467.0)
Attributable to owners of the entity	(156.5)	6.4	13.0	5.8	(248.8)	(380.1)	(85.0)	—	(465.1)
Attributable to non-controlling interests	(3.2)	0.2	—	1.1	—	(1.9)	—	—	(1.9)

	Alice International Condensed Consolidated Financial Information	OMT 6m (Note 3c)	ONI 7m (Note 3d)	Ma Chaine Sport 9m (Note 3e)	SportV 9m (Note 3f)	Refinancing adjustments related to refinancing (Notes 3g,3h)	ODO 9m (Note 3a)	Issuance of new debt to finance the Acquisition (Note 3b)	Alice International Pre-PT Portugal Group Pro forma accounts	PT Portugal Group (Note 3b)	Intercompany transactions (Note 3j)	Alice International Post Transaction Pro Forma accounts
	January 1, 2013 to September 30, 2013	January 1, 2013 to July 4, 2013	January 1, 2013 to August 8, 2013	January 1, 2013 to September 30, 2013	January 1, 2013 to September 30, 2013	January 1, 2013 to September 30, 2013	January 1, 2013 to September 30, 2013	January 1, 2013 to September 30, 2013	January 1, 2013 to September 30, 2013	January 1, 2013 to September 30, 2013	January 1, 2013 to September 30, 2013	January 1, 2013 to September 30, 2013
In Million €												
Revenue.....	928.4	96.5	59.0	13.8	4.5	—	333.9	—	1,436.1	1,963.2	(24.3)	3,375.0
Purchases and subcontracting												
services.....	(262.2)	(30.1)	(31.2)	(3.4)	(1.1)	—	(101.5)	—	(429.7)	(414.6)	20.6	(823.8)
Other operating expenses.....	(289.2)	(33.2)	(18.4)	(3.4)	(0.3)	—	(100.7)	—	(444.9)	(772.9)	3.8	(1,214.0)
Operating income before												
depreciation & amortisation.....	377.0	33.2	9.4	7.0	3.1	—	131.7	—	561.5	775.7	—	1,337.2
Depreciation and amortization.....	(278.0)	(11.4)	(9.9)	(4.7)	(1.1)	—	(47.1)	—	(352.2)	(594.7)	—	(946.9)
Management fees.....	(.7)	(.4)	—	(0.4)	—	—	(8.6)	—	(10.2)	—	—	(10.2)
Restructuring, non-recurring costs and other expenses.....	(12.3)	(2.0)	(2.2)	—	—	(7.0)	(0.5)	—	(24.0)	(165.2)	—	(189.2)
Operating profit/(loss).....	86.0	19.4	(2.7)	1.9	2.0	(5.9)	75.5	—	175.1	15.8	—	190.9
Financial income.....	36.2	0.2	—	—	—	—	0.5	—	36.9	—	—	36.9
Finance costs.....	(184.3)	(2.2)	(5.7)	—	—	(58.7)	—	(248.8)	(499.7)	(205.8)	—	(705.5)
Share in income of associates.....	—	—	—	—	—	—	—	—	—	3.2	—	3.2
(Loss)/Profit before income tax												
expenses.....	(62.1)	17.4	(8.4)	1.9	2.0	(65.7)	76.0	(248.8)	(287.7)	(186.8)	—	(474.5)
Income tax expense.....	(27.4)	(6.5)	(0.3)	(0.3)	—	(0.8)	(21.5)	—	(56.8)	(34.1)	—	(90.9)
(Loss)/Profit for the period.....	(89.5)	10.9	(8.8)	1.7	2.0	(66.5)	54.5	(248.8)	(344.5)	(220.9)	—	(565.4)
Attributable to owners of the entity.....	(83.3)	10.9	(8.8)	1.7	1.9	(71.4)	52.9	(248.8)	(344.5)	(220.9)	—	(565.7)
Attributable to non-controlling interests.....	(6.0)	—	—	—	—	4.9	1.5	—	0.4	—	—	0.4

For the twelve month ended December 31, 2013	Altice					Refinancing adjustments related to previous deals (Notes 3g, 3h)	Altice			Issuance of new debt to finance the Acquisition (Note 3b)	Altice
	International Consolidated Financial Information	OMT 6m (Note 3c)	ONI 7m (Note 3d)	Ma Chaîne Sport 9m (Note 3e)	SportV 9m (Note 3f)		International Pre-PT/ODO pro-forma accounts	ODO (Note 3a)	International Pre-PT Portugal Group Pro form accounts		
							In Million €				
Revenue	1,286.8	96.5	59.0	13.8	4.5	—	1,460.6	446.3	—	—	1,906.6
Purchases and subcontracting services	(367.8)	(30.1)	(31.2)	(3.4)	(1.1)	—	(433.6)	(121.6)	—	—	(555.2)
Other operating expenses	(400.3)	(33.2)	(18.4)	(3.4)	(0.4)	—	(455.8)	(151.6)	—	—	(607.4)
Operating income before depreciation & amortisation	518.7	33.2	9.4	7.0	3.1	—	571.2	173.1	—	—	743.4
Depreciation and amortization	(399.6)	(11.4)	(9.9)	(4.7)	(1.1)	—	(426.7)	(64.3)	—	—	(491.0)
Management fees	(.6)	(.4)	—	(0.4)	—	—	(1.4)	(11.5)	—	—	(12.9)
Restructuring, non-recurring costs and other expenses	(76.3)	(2.0)	(2.2)	—	—	(7.0)	(87.5)	0.1	—	—	(87.4)
Operating profit/(loss)	42.2	19.4	(2.7)	1.9	2.0	(7.0)	55.6	97.4	—	—	153.1
Financial income	93.6	0.2	—	—	—	—	93.8	0.5	—	—	94.3
Finance costs	(336.9)	(2.2)	(5.7)	—	—	(140.9)	(485.7)	(1.1)	(331.7)	—	(818.3)
Share in income of associates	—	—	—	—	—	—	—	—	—	—	—
(Loss)/Profit before income tax expenses	(201.1)	17.4	(8.4)	1.9	2.0	(147.9)	(336.3)	96.8	(331.7)	—	(571.2)
Income tax expense	(7.4)	(6.5)	(0.3)	(0.3)	—	—	(14.5)	(25.4)	—	—	(39.9)
(Loss)/Profit for the year	(208.5)	10.9	(8.8)	1.7	2.0	(147.9)	(350.8)	71.4	(331.7)	—	(611.3)
Attributable to owners of the entity	(186.2)	10.9	(8.8)	1.7	2.0	(169.1)	(349.6)	69.4	(331.7)	—	(612.7)
Attributable to non-controlling interests	(22.2)	—	—	—	—	21.2	(1.0)	2.0	—	—	1.6

September 30, 2014	Altice International Condensed Consolidated Statement of Financial Position	Coditel mezzanine repayment (Note 3h)	PT- Portugal Group (Note 3b)	Adj. related to the Transactions (Note 3b)	Intercompany transactions (Note 3j)	Altice International Post Transaction Pro Forma Accounts Sep 30, 2014
	(All Values in €' millions)					
ASSETS						
Current assets						
Cash and cash equivalents	141.3	(0.2)	243.5	(243.5)	—	141.1
Restricted cash	—	—	—	—	—	—
Trade and other receivables	292.9	—	922.6	—	(9.0)	1,206.4
Inventories	21.9	—	75.5	—	—	97.4
Current tax assets	15.1	—	85.1	—	—	100.2
Total current assets	471.2	(0.2)	1,326.7	(243.5)	(9.0)	1,545.1
Non-current assets						
Deferred tax assets	98.7	—	391.5	—	—	490.2
Investment in associates	—	—	20.7	—	—	20.7
Financial assets	48.6	—	25.9	—	—	74.5
Trade and other receivables	26.9	—	3.7	—	—	30.6
Property, plant & equipment	1,441.7	—	3,103.7	—	—	4,545.4
Intangible assets	665.8	—	574.5	—	—	1,240.3
Goodwill	2,050.0	—	3,723.7	(962.3)	—	4,811.4
Total non-current assets	4,331.7	—	7,843.7	(962.3)	—	11,213.1
Total assets	4,802.7	(0.2)	9,170.4	(1,205.8)	(9.0)	12,758.2
LIABILITIES AND EQUITY						
Current liabilities						
Borrowings	102.2	—	1,817.8	(1,817.8)	—	102.2
Deferred revenue	100.9	—	159.0	—	—	259.9
Trade and other payables	535.6	—	823.7	—	(8.9)	1,350.5
Other current liabilities	63.3	—	—	—	—	63.3
Provisions	2.4	—	49.9	—	(2)	52.2
Current tax liabilities	81.3	—	90.9	—	—	172.2
Total current liabilities	885.7	—	2,941.3	(1,817.8)	(9.0)	2,000.1
Non-current liabilities						
Borrowings	3,581.6	6.2	4,012.4	273.3	—	7,873.5
Other financial liabilities	185.9	—	19.0	—	—	204.9
Deferred revenue	11.3	—	—	—	—	11.3
Trade and other payables	17.2	—	19.0	—	—	36.2
Retirement benefit obligations	8.2	—	1,073.6	—	—	1,081.8
Provisions	36.6	—	1.3	—	—	37.9
Deferred tax liabilities	169.5	—	141.5	—	—	311.0
Total non-current liabilities	4,010.3	6.2	5,266.8	273.3	—	9,556.7
Equity						
Total equity attributable to the shareholders of the parent	(94.3)	(6.4)	962.3	338.6	—	1,200.2
Non-controlling interests	1.0	—	—	—	—	1.0

Total equity	<u>(93.3)</u>	<u>(6.4)</u>	<u>962.3</u>	<u>338.6</u>	<u>—</u>	<u>1,201.2</u>
Total liabilities and equity	<u>4,802.7</u>	<u>(.2)</u>	<u>9,170.4</u>	<u>(1,205.8)</u>	<u>(9.0)</u>	<u>12,758.2</u>

ALTICE INTERNATIONAL S.à r.l.
NOTES TO THE UNAUDITED PRO FORMA CONSOLIDATED FINANCIAL INFORMATION

1—General information

The accompanying unaudited pro forma consolidated statement of income for the nine and twelve month periods ended September 30, 2014 and September 30, 2013, and the twelve month period ended December 31, 2013, the accompanying unaudited pro forma consolidated statement of financial position as of September 30, 2014 and these explanatory notes (together the “Unaudited Pro Forma Financial Information”) present the unaudited pro forma consolidated financial information of Altice International S.à r.l. (the “Company” or the “Group”), giving effect to each of the acquisitions and the other transactions described in the basis of preparation described in note 2.

The Unaudited Pro Forma Financial Information does not give pro forma effect to the Group’s acquisition of Mobius S.A.S (“Mobius”) for the nine month periods ended September 30, 2013 and December 31, 2013. However, as a result of the acquisition of the Mobius Group on January 15, 2014, the pro-forma condensed consolidated statement of income for the nine months ended September 30, 2014 contains information pertaining to the Mobius Group. The Board of Managers has concluded that these are not significant for the purpose of preparing the accompanying Unaudited Pro Forma Financial Information. Additionally, the unaudited Pro Forma Financial Information does not give pro forma effect to the Group’s acquisition of Tricom S.A., Global Interlink Limited and their subsidiaries (“Tricom”) for the nine and twelve month periods ended September 30, 2013 and December 31, 2013 respectively. However, as a result of the acquisition of the Tricom Group on March 12, 2014, the pro-forma condensed consolidated statement of income for the nine months ended September 30, 2014 contains information pertaining to the Tricom Group. The Board of Managers has concluded that these are not significant for the purpose of preparing the accompanying Unaudited Pro Forma Financial Information. For the nine months ended September 30, 2014, the Mobius Group and Tricom Group contributed €13.1 million and € 82.0 million to the Company’s revenues and €1.0 million and €14.1 million to the Company’s operating income respectively. The Unaudited Pro Forma Financial Information also does not give effect to the disposal of the assets of Outremer Telecom that are located in the Indian Ocean region, as this disposal is not deemed to be significant by the Board of Managers. In October 2014, the Company, through its indirect subsidiary, Altice Africa S.à r.l. acquired an additional stake in Wananchi Group (Holdings) Ltd for a total cash amount of EUR 8.6 million. Management has deemed that this acquisition is not significant for the purposes of these accounts and hence no pro forma effect has been given to this transaction. The Unaudited Pro Forma Financial Information does not give effect to any hedging effects that the Company or the Group may enter into to cover its different financing and acquisitions. The Unaudited Pro Forma Financial Information has not been audited or reviewed.

The Unaudited Pro Forma Financial Information does not purport to be indicative of the financial position and results of operations that the Group will obtain in the future, or that the Group would have obtained if the significant acquisitions and disposals described in the basis of preparation below occurred with effect from the dates indicated. The pro forma adjustments are based upon currently available information and upon certain assumptions that the Board of Managers of the Company believes to be reasonable.

For the purposes of this Unaudited Pro Forma Financial Information, and in relation to the Group’s acquisition of PT Portugal Group (“PT”) any difference between (a) the total consideration transferred measured in accordance with IFRS 3 *Business Combinations* (“IFRS 3”) and (b) the net of the acquisition-date amounts of the identifiable assets acquired and the liabilities assumed, has been allocated to goodwill. Definitive allocations will be performed and finalized based upon certain valuations and other studies that will be performed with the services of outside valuation specialists after the closing of the aforementioned acquisitions. Accordingly, the determination of the amount of goodwill is preliminary and has been made solely for the purpose of preparing the unaudited pro forma condensed consolidated financial information and is subject to revision based on a final determination of fair value of assets acquired and liabilities assumed at the end of the measurement period for PT.

The Unaudited Pro Forma Financial Information should be read in conjunction with the assumptions underlying the pro forma adjustments which are described in these notes as well as the historical and other financial statements included in these Listing Particulars.

2—Basis of preparation

The Unaudited Pro Forma Financial Information has been prepared to give effect to the following transactions as if they occurred on January 1, 2013 for the purposes of the unaudited pro forma consolidated statements of income and, if applicable, on September 30, 2014 for the purpose of the unaudited condensed consolidated pro forma statement of financial position:

- The acquisition by the Company or its subsidiaries of:

- 99.7% of the share capital of OMT Invest S.A.S. in two tranches of 77% and 22.7% respectively;
 - A supplementary 40% of the share capital of Altice Portugal and its direct subsidiary Cabovisao;
 - 100% of the share capital of Winreason S.A.;
 - 100% of the share capital of Sportv S.A.;
 - 100% of the share capital of Ma Chaîne Sport S.A.S.;
 - A supplementary 40% of the share capital of Coditel Holding Lux II S.à r.l.
 - 97.2% of the share capital of Orange Dominicana S.A.S. (later renamed Altice Hispaniola S.A.S.).
- The planned acquisition by the Company and/or its subsidiaries of 100% of the share capital of PT Portugal and its subsidiaries as defined by the carve-out perimeter. A description of the planned carve out steps and adjustments is provided elsewhere in the Listing Particulars.
- The following Refinancing Transactions
 - The issuance by subsidiaries of the Company of:
 - 9% EUR 250 million Senior Secured Notes falling due in 2023;
 - 6¹/₂% \$900 million Senior Secured Notes due in 2022;
 - 8¹/₈% \$400 million Senior Secured Notes due in 2024;
 - The planned issuance by the Company and its subsidiaries of:
 - 5.25% EUR 400 million term loan due in 2022;
 - 5.25% USD 500 million term loan due in 2022;
 - 5.25% EUR 500 million Senior Secured Notes due in 2023;
 - 6.625% USD 2,060 million Senior Secured Notes due in 2023;
 - 7.625% USD 385 million Senior Notes falling due in 2025;
 - The obtaining of a senior secured term loan B credit facility agreement for an amount equivalent to EUR 795 million;
 - The repayment of the Coditel Mezzanine facility amounting to EUR 125.7 million;
 - The repayment of the Coditel Senior Facility amounting to EUR 138 million;
 - The repayment of the ABO credit facility amounting to EUR 65.6 million;
 - The repayment of the Cabovisao facility amounting to EUR 202.6 million; and
 - The repayment of the ONI facility amounting to EUR 47.3 million.
 - The planned issuance of Mandatory Convertible Notes (“MCN”) to be fully subscribed by its sole shareholder for a total amount of up to EUR 2,055 million (excluding transaction fees).
 - The obtaining of an additional revolving credit facility amounting to a total of EUR 180 million.
 - The borrowing costs on the aforementioned drawn amounts have been included in the unaudited pro forma statement of income for the nine months ended September 30, 2013 and 2014 and the year ended December 31, 2013.

As mentioned above, given the timing of the Acquisition, assets acquired and liabilities assumed of the PT Portugal Group are reflected in the unaudited pro forma consolidated statement of financial position as of September 30, 2014 at their historical book value reflected in the PT Portugal Combined Selected Financial Information for the nine months ended September 30, 2014, and have not been adjusted. The determination of the amount of goodwill is preliminary and has been made solely for the purpose of preparing the Unaudited Pro Forma Financial Information and is subject to revision based on a final determination of fair value after the closing of the acquisitions mentioned above. Under IFRS, goodwill is not amortized, but is tested for impairment at least annually, and therefore, the unaudited pro forma consolidated statement of income does not include any amortization expense in relation to the identifiable assets acquired. Upon finalization of the amount of goodwill, certain identifiable assets acquired such as licenses, trademarks and customer base will have a finite life and will be amortized. As a result, the future results of consolidated operations of Altice International S.à r.l. could be significantly affected by amortization expense in relation to such identifiable assets acquired.

On April 23, 2013, an indirect subsidiary of the Company acquired the remaining 40% of the share capital of Cabovisao. The Group had acquired control over Cabovisao on February 29, 2012 and the acquisition was accounted for using the purchase method of accounting with the assets acquired and liabilities assumed recorded at their estimated fair values at the date of acquisition. The assets acquired and liabilities assumed of Cabovisao are reflected in the condensed consolidated statement of financial position as of September 30, 2014. Therefore, this transaction has not been deemed to result in any adjustments to the unaudited pro forma consolidated statement of financial position. Accordingly, the relevant pro-forma effects on the non-controlling interests resulting from the increase in the Group's shareholding from 60% to 100% have been included in the unaudited pro forma consolidated statements of income for the nine months ended September 30, 2013 and the year ending on December 31, 2013.

On June 14, 2013, Altice Finco S.A., an indirect subsidiary of the Company, issued 9% Senior Notes for an aggregate principal of EUR 250 million maturing in 2023. Such liabilities are reflected in the condensed consolidated statement of financial position as of September 30, 2014. Therefore, this transaction has not been deemed to result in any adjustments to the unaudited pro forma consolidated statement of financial position as of September 30, 2014. Accordingly, the relevant pro-forma effects of the resulting borrowing costs on the aforementioned drawn amount for the period between January 1, 2013 and June 14, 2013 have been included in the unaudited pro forma consolidated statement of income for the nine months ended September 30, 2013 and the year ending on December 31, 2013.

On June 24, 2013, Altice Financing S.A., an indirect subsidiary of the Company, entered into a senior secured credit facility agreement providing for term loans for a total equivalent amount of EUR 795 million. As of September 30, 2014, the full amount of EUR 795 million has been drawn under this facility. The corresponding liability is reflected in the condensed consolidated statement of financial position as of September 30, 2014. Therefore, this transaction has not been deemed to result in any adjustments to the unaudited pro forma consolidated statement of financial position. Accordingly, the relevant pro-forma effects of the resulting borrowing costs on the aforementioned drawn amount for the period between January 1, 2013 and June 24, 2013 have been included in the unaudited pro forma consolidated statements of income for the nine months ended September 30, 2013 and the year ending on December 31, 2013.

On July 2, 2013, Cabovisao repaid its credit facility for an amount of EUR 202.6 million. The corresponding operation is reflected in the condensed consolidated statement of financial position as of September 30, 2014. Therefore, this transaction has not been deemed to result in any adjustments to the unaudited pro forma consolidated statement of financial position. Accordingly, the relevant pro-forma effects of the resulting borrowing costs on the aforementioned drawn amount for the period between January 1, 2013 and July 2, 2013 have been included in the unaudited pro forma consolidated statements of income for the nine months ended September 30, 2013 and the year ending on December 31, 2013.

On July 4, 2013, an indirect subsidiary of the Company acquired 77% of the share capital of OMT Invest S.A. ("OMT"). On June 27, 2014, the Company acquired the remaining 22.7% of the share capital of OMT. The acquisition was accounted for using the purchase method of accounting and the assets acquired and liabilities assumed were recorded at their estimated fair values at the date of acquisition. The assets acquired and liabilities assumed of OMT are reflected in the condensed consolidated statement of financial position as of September 30, 2014. Therefore, this transaction has not been deemed to result in any adjustments to the unaudited pro forma consolidated statement of financial position. The results of operations for OMT have been included in the consolidated statement of income of the Company since the date of acquisition on July 4, 2013. The OMT historical consolidated income statement for the period from January 1, 2013 through July 3, 2013 have hence been included in the unaudited pro forma consolidated statements of income for the nine months ended September 30, 2013 and the year ending on December 31, 2013.

On August 8, 2013, an indirect subsidiary of the Company acquired 100% of the share capital of Winreason S.A. ("ONI"). The acquisition was accounted for using the purchase method of accounting and the assets acquired and liabilities assumed were recorded at their estimated fair values at the date of acquisition. The assets acquired and liabilities assumed of ONI are reflected in the condensed consolidated statement of financial position as of September 30,

2014, at their fair value and a purchase price allocation has been completed. Accordingly, this transaction has not been deemed to result in any adjustments to the unaudited pro forma consolidated statement of financial position. The results of operations for ONI have been included in the historical consolidated statement of income since the date of acquisition on August 8, 2013. The ONI historical consolidated income statement for the period from January 1, 2013 through August 7, 2013 have been included in the unaudited pro forma consolidated income statement for the nine months ended September 30, 2013 and the year ending on December 31, 2013. As per the requirements of IFRS 3, *Business Combinations*, the comparative historical period for ONI included in the condensed consolidated statement of income of the Company for the nine months ended September 30, 2013 has been restated to reflect the impact of the recognition of the fair value of the assumed assets and liabilities of ONI on the amortization and depreciation expense for the period in question.

On August 8, 2013, ONI repaid its credit facility for an amount of EUR 47.3 million. The corresponding operation is reflected in the condensed consolidated statement of financial position as of September 30, 2014. Therefore, this transaction has not been deemed to result in any adjustments to the unaudited consolidated pro forma statement of financial position. Accordingly, the relevant pro-forma effects of the resulting borrowing costs on the aforementioned drawn amount for the period between January 1, 2013 and August 8, 2013 have been included in the unaudited pro forma consolidated statements of income for the nine months ended September 30, 2013 and the year ending on December 31, 2013.

On October 1, 2013, an indirect subsidiary of the Company integrated in the Altice International group 100% of the share capital of Ma Chaîne Sport SAS (“MCS”). The Board of Managers has not accounted for this transaction using the purchase method of accounting as it relates to a transaction performed under the common control of the ultimate beneficial owner of the Company. The corresponding operation is reflected in the condensed consolidated statement of financial position as of September 30, 2014. Therefore, this transaction has not been deemed to result in any adjustments to the unaudited pro forma consolidated statement of financial position. However, the relevant pro forma effects of the unconsolidated period between January 1, 2013 and October 4, 2013 have been included in the unaudited pro forma consolidated statement of income for the nine months ended September 30, 2013 and the year ending on December 31, 2013.

On October 1, 2013, an indirect subsidiary of the Company integrated in the Altice International group 100% of the share capital of Sportv S.A. (“Sportv”). The Board of Managers has not accounted for this transaction using the purchase method of accounting as it relates to a transaction performed under the common control of the ultimate beneficial owner of the Company. The corresponding operation is reflected in the consolidated statement of financial position as of September 30, 2014. Therefore, this transaction has not been deemed to result in any adjustments to the unaudited pro forma consolidated statement of financial position. However, the relevant pro forma effects of the unconsolidated period between January 1, 2013 and October 4, 2013 have been included in the unaudited pro forma consolidated income statements in the nine months ended September 30, 2013 and the year ending on December 31, 2013.

On November 29, 2013, an indirect subsidiary of the Company acquired an additional 40% of the share capital of Coditel Holding Lux II S.à r.l. (“Coditel”) and reimbursed certain Preferred Equity Certificates held by the non-controlling interests in this entity. The corresponding operation is reflected in the condensed consolidated statement of financial position as of September 30, 2014. Therefore, this transaction has not been deemed to result in any adjustments to the unaudited pro forma consolidated statement of financial position. Accordingly, the relevant pro forma effects of the resulting borrowing costs and change in non controlling interests on the aforementioned operation for the period between January 1, 2013 and November 29, 2013 have been included in the unaudited pro forma consolidated statements of income for the nine months ended September 30, 2013 and the year ending on December 31, 2013.

On December 5, 2013, Altice Financing S.A., an indirect subsidiary of the Company, proceeded with the issuance of 6¹/₂ Senior Secured Notes for an aggregate principal of \$ 900 million maturing in 2022. The corresponding operation is reflected in the condensed consolidated statement of financial position as of September 30, 2014. Therefore, this transaction has not been deemed to result in any adjustments to the unaudited pro forma consolidated statement of financial position. Accordingly, the relevant pro forma effects of the resulting borrowing costs on the aforementioned operation for the period between January 1, 2013 and December 5, 2013 have been included in the unaudited pro forma consolidated statements of income for the nine months ended September 30, 2013 and the year ending on December 31, 2013.

On December 5, 2013, Altice Finco S.A., an indirect subsidiary of the Company, proceeded with the issuance of 8¹/₈% Senior Notes for an aggregate principal of \$ 400 million maturing in 2024. The corresponding operation is reflected in the condensed consolidated statement of financial position as of September 30, 2014. Therefore, this transaction has not been deemed to result in any adjustments to the unaudited pro forma consolidated statement of financial position. Accordingly, the relevant pro forma effects of the resulting borrowing costs on the aforementioned operation for the period between January 1, 2013 and December 5, 2013 have been included in the unaudited pro forma consolidated statements of income for the nine months ended September 30, 2013 and the year ending on December 31, 2013.

On April 9, 2014, the Company acquired 97.2% of the share capital of Orange Dominicana S.A. (“ODO”). The excess of the acquisition price over the historical book value of the non-controlling interests was recorded as goodwill after a preliminary purchase price allocation. The Board of Managers has not conducted any impairment analysis on this goodwill generated from this allocation for the purpose of preparing this financial information. The assets acquired and liabilities assumed of ODO are reflected in the consolidated statement of financial position as of September 30, 2014, and the difference between the consideration paid and the net asset position has been provisionally accounted for as goodwill, except for two identifiable assets that were recognized at the provisional fair values at the time of acquisition. These assets consist of the right to use the Orange brand in the Dominican Republic for a period of three years (plus an option of two additional years) and the capitalization of subscriber acquisition costs in line with Group accounting policies. Accordingly, this transaction has not been deemed to result in any adjustments to the unaudited pro forma consolidated statement of financial position. The results of operations for ODO have been included in the historical consolidated statement of income since the date of acquisition on April 9, 2014. The historical consolidated income statement of ODO, for the period from January 1, 2014 through April 8, 2014 have been included in the unaudited pro forma condensed consolidated income statement for the nine months ended September 30, 2014. However, for practicality reasons, the data pertaining to the six month period from April 9, 2014 to September 30, 2014 has been deducted from the historical consolidated financial information of the Group, and a pro-forma adjustment reflecting the income statement for the period from January 1, 2014 to September 30, 2014 has been presented. This has been done to ensure comparability of information for the nine month periods ended September 30, 2014 and 2013 respectively for the purpose of the Management Discussion and Analysis of ODO.

On December 2, 2014, the Company refinanced the mezzanine facility issued by Coditel Holding S.A. for a total amount of EUR 125.7 million (this included the PIK interest due on the debt as well as the break costs of 6.75%). Given that this transaction occurred after September 30, 2014, this refinancing has not been included in the condensed consolidated statement of financial position as of September 30, 2014. Accordingly, adjustments have been made to the unaudited pro forma consolidated statement of financial position in order to reflect this new acquisition as if it had occurred on September 30, 2014 as well as in the unaudited pro forma consolidated statements of income for the nine months ended September 30, 2013, for the nine months ended September 30, 2014 and the year ending on December 31, 2013.

In January 2015, Altice Finco S.A. and Altice Financing S.A., two subsidiaries of Altice International S.à r.l., intend to proceed with the issuance of the Notes and entry into a term loan credit facility in an amount of EUR 3,498 million (equivalent). Given that such issuance will occur after September 30, 2014, the liabilities arising from the issuance are not included in the condensed consolidated statement of financial position as of September 30, 2014. Accordingly, adjustments have been made to the unaudited pro forma consolidated statement of financial position in order to reflect this transaction as if it had occurred on September 30, 2014. Accordingly, the relevant pro forma effects of the resulting borrowing costs on the aforementioned operation for the period between January 1, 2013 and September 30, 2014 have been included in the unaudited pro forma consolidated statements of income for the nine months ended September 30, 2013, for the nine months ended September 30, 2014 and the year ending on December 31, 2013.

In addition to the debt issuances mentioned above, the Company will proceed with the issuance of Mandatory Convertible Notes for a total amount of up to EUR 2,055 million. Given that such issuance will occur after September 30, 2014, the liabilities arising from the issuance are not included in the condensed consolidated statement of financial position as of September 30, 2014. Accordingly, adjustments have been made to the unaudited pro forma statement of financial position in order to reflect this transaction as if it had occurred on September 30, 2014. Accordingly, the relevant pro forma effects of the resulting borrowing costs on the aforementioned operation for the period between January 1, 2013 and September 30, 2014 have been included in the unaudited pro forma consolidated statements of income for the nine months ended September 30, 2013, for the nine months ended September 30, 2014 and the year ending on December 31, 2013.

On December 9, 2014, the Company signed an offer to acquire the Portuguese and Hungarian assets of Portugal Telecom from Oi and is subject to works council procedures and to certain conditions precedent, including antitrust approval. The main details of this offer are outlined in the section entitled, “The Transactions” elsewhere in these Listing Particulars. After the completion of the transaction, the Company is expected to hold 100% of the PT Portugal Group. The excess of the purchase price over the historical book value will be recorded as goodwill after a preliminary purchase price allocation. The Board of Managers has not conducted any impairment analysis on this goodwill generated from this allocation for the purpose of preparing this financial information. However, this does not purport to represent any adjustments resulting from the allocation of the consideration that will be paid by the Group to acquire PT Portugal. Given that such acquisitions will occur after September 30, 2014, the assets acquired and liabilities assumed of PT Portugal are not included in the condensed consolidated statement of financial position as of September 30, 2014. Accordingly, adjustments have been made to the unaudited pro forma consolidated statement of financial position in order to reflect this transaction as if it had occurred on September 30, 2014. The historical combined statements of income for the period from January 1, 2013 through December 31, 2013, January 1, 2013 to September 30, 2013 and from January 1, 2014 to September 30, 2014 have hence been included in the unaudited pro forma consolidated statement

of income for the nine months ended December 31, 2013 and September 30, 2013 and the year ended September 30, 2014, respectively.

The Unaudited Pro Forma Financial Information has been prepared for illustrative purposes. It has not been prepared in accordance with the requirements of Regulation S- X under the U.S. Securities Act or any generally accepted accounting standards nor has it been audited or reviewed. Because of its nature, it addresses a hypothetical situation and, therefore, does not represent the Group's actual financial position or results. It does not purport to indicate the results of operations or the financial position that would have resulted had the transactions been completed at the beginning of the period presented, nor is it intended to be indicative of expected results of operations in future periods or the future financial position of the Group. The pro forma adjustments are based upon available information and certain assumptions that the Company believes to be reasonable. In addition, they do not reflect cost savings or other synergies resulting from the acquisitions that may be realized in future periods. The Unaudited Pro Forma Financial Information does not reflect any special items such as payments pursuant to contractual change-of-control provisions or restructuring and integration costs which may be incurred as a result of the transactions described below. The unaudited Pro Forma Financial Information does not give effect to the Mobius Acquisition, Tricom Acquisition for the nine month period ended September 30, 2013 or the full year ended December 31, 2013. However, since the acquisition of Mobius S.A.S in January 2014 and of Tricom in March 2014, the results of these entities are included in the historical condensed consolidated statement of income and consolidated condensed statement of financial position of the Group for the nine months ended September 30, 2014. The unaudited pro- forma financial does not give effect to the disposal of the mobile assets of Outremer Telecom based in the Reunion Islands and Mayotte.

There are certain differences in the way in which PT Portugal and the Company. present items on their respective statements of financial position and statements of income. As a result, certain items have been reclassified in the Unaudited Pro Forma Consolidated statements of income to comply with Altice International's presentation. There could be additional reclassifications and remeasurements following completion of the PT Portugal Acquisition.

The unaudited Pro Forma Financial Information should be read in conjunction with the notes thereto as well as the historical consolidated financial statements of the Company included herein.

In ODO, no pro forma effects have been given to the capitalization of subscriber acquisition costs (and related depreciation) for the nine months ended September 30, 2013, and year ended December 31, 2013, given the Board has concluded these are not material.

Historical consolidated financial statements

The historical consolidated financial statements of the Company are represented by the consolidated financial statements of the Company as of and for the three month and nine month ended September 30, 2014 (and the comparative period for the three month and nine months ended September 30, 2013) prepared in accordance with IAS 34 and as of and for the year ended December 31, 2013, prepared in accordance with International Financial Reporting Standards as adopted for use in the European Union ("IFRS").

3—Pro-forma adjustments

(a) Acquisition of ODO

Altice Dominican Republic II S.A.S, an indirectly fully-owned subsidiary of Altice International obtained control of ODO on April 9, 2014 further to a purchase of 97.2% of its shares. These pro-forma adjustments relate to the historical income statement of ODO for the period from January 1, 2013 to December 31, 2013 and from January 1, 2014 to April 9, 2014 derived respectively from the unaudited financial statements of ODO prepared in accordance with the measurement and recognition criteria of IFRS, to which certain reclassifications were made to conform to the presentation of the accompanying unaudited pro forma statements of income and from the historical condensed consolidated financial statements of Altice International S.à r.l. as of and for the three month and nine month period ended September 30, 2014.

The pro-forma adjustments pertain to the extraction of the result of Orange Dominicana for the period from April 9, 2014 through September 30, 2014 and adding back the results of the nine month period from January 1, 2014 through September 30, 2014.

(b) Acquisition of PT Portugal (adjustments related to the Altice perimeter)

In connection with the Transactions, the Group, through its subsidiary, Altice Portugal S.A., contemplates acquiring a 100.0% stake in the PT Portugal Group. Pro-forma adjustments relating to this transaction are reflected below and pertain to the pro-forma adjustments made by Altice International to reflect the impact of the transaction on its accounts.

In order to finance this acquisition, the Group, through its indirect subsidiaries Altice Finco S.A. and Altice Financing S.A. intends to issue the New Loans and Senior and Senior Secured Notes bearing a blended interest of 5.7%. These debts fall due in 2022, 2025 and 2023 respectively. The Company will also issue Mandatory Convertible Notes for a total amount of EUR 2,055 million, which will be fully subscribed by Altice S.A. These notes will bear interest at a rate of 6.4% and will become due in 2025. As per the provisions of IAS 32, the fair value of the coupon payments is characterised as debt and the remainder of the principal amount as equity. Additionally, the Group will acquire and draw on a new revolving credit facility for a total amount of EUR 180 million bearing interest at 3.65%. The Pro forma adjustments relating to the new debt issuance are composed as follows:

- Payment of the purchase price to the vendors as agreed in the sale and purchase agreement.
- Payment of EUR 128.1 million as underwriting and other fees related to the issuance of the new debts.

Pro-forma adjustments of EUR 248.8 million and EUR 331.7 million have been recorded for the nine month periods ended September 30, 2014 and 2013, and the twelve months ended December 31, 2013 respectively to reflect the net change to finance costs on borrowings and non-recurring deal fees, that would have been recorded had the above debt issuance taken place on January 1, 2013.

Actual interest rates at the time of pricing may differ from the indicative rate used herein. In case of a +/- 10 basis points change in the interest rate, the final interest expense adjustment would have an impact of +/- EUR 3.3 million for the twelve months ended December 31, 2013 and +/- EUR 2.5 million for the nine months ended September 30, 2013 and September 30, 2014.

	Acquisition of PT Portugal Shares	Debt Settlement	Cash free adjustment	Total impact of the proposed issuance
€ in millions				
ASSETS				
Current assets				
Cash and cash equivalents.....	—	—	(243.5)	(243.5)
Total Current assets	—	—	(243.5)	(243.5)
Non-current assets				
Goodwill	(962.3)	—	—	(962.3)
Total non-current assets				
Total assets	(962.3)	—	(243.5)	(1,205.8)
EQUITY AND LIABILITIES				
Current liabilities				
Borrowings	—	(1,817.8)		(1,817.8)
Total current liabilities	—	(1,817.8)		(1,817.8)
Non-current liabilities				
Borrowings	—	516.9	(243.5)	273.3
Total non-current liabilities	—	516.9	(243.5)	273.3
Equity				
Invested equity	(962.3)	1,300.9	—	338.6
Total equity	(962.3)	1,300.9	—	338.6
Total equity and liabilities	(962.3)	—	(243.5)	(1,205.8)

(a) The net assets acquired of PT Portugal Group as their historical amounts as if the acquisition took place as at December 31, 2013. The value of the equity acquired (EUR 962.3 million) has been computed as the aggregation of (i) the equity of the combined PT Portugal Group as at September 30, 2014 for EUR 962.3 million minus (ii) the existing goodwill recorded in the books of the combined PT Portugal Group prior to its acquisition by Altice International. Thus provisional goodwill of EUR 2,761.4 million has been recorded in the pro-forma statement of financial position.

(b) Provisional goodwill has been determined with regards to the acquisition of PT Portugal, and is calculated as the difference between the consideration transferred to the owners and the estimated acquisition date assumed fair value of the assets and liabilities acquired, as required by IFRS 3, 'Business combinations'. The SPA also includes an earn out due to the vendors in the event that certain pre-determined conditions are agreed in the fifth year following the closing of the transaction. As per the requirements of IFRS 3, this contingent consideration was valued at its fair value, using the probability weighted average fair value method (corresponding to the present value of the future payout, discounted at the weighted average cost of capital (WACC) of the Group and assuming a probability of occurrence for each discreet payout scenario). The following adjustments have been made to reflect the impact of the acquisition on the pro-forma accounts. The cash consideration expected to be paid to the vendors to acquire shares in the new PT Portugal Group, amounting to EUR 1.

(c) Subsequently, the PT Portugal Group will use the proceeds from the new debt and Mandatorily Convertible Notes issuance to reimburse shareholder loans held by the vendors for a total amount of EUR 5,604.0 million. The cash position of the PT Portugal Group has been cancelled as it is assumed that PT will be sold to Altice on a cash free basis. The Mandatorily Convertible Notes have been reflected for in accordance with IAS 32 with an equity and a debt portion.

(c) Acquisition of OMT

Altice Blue Two S.A.S., an indirectly fully-owned subsidiary of Altice International obtained control of OMT on July 4, 2013 pursuant to a purchase of 77% of its shares. These pro-forma adjustments relate to the historical statement of income of OMT for the period from January 1, 2013 through July 4, 2013 derived from the unaudited financial statements of OMT prepared in accordance with the measurement and recognition criteria of IFRS, to which certain reclassifications were made to conform to the presentation of the accompanying unaudited pro forma statements of income.

(d) Acquisition of Winreason S.A.

Cabovisao, an indirectly fully-owned subsidiary of Altice International obtained control of Winreason on August 8, 2013 pursuant to a purchase of 100% of its shares. These pro-forma adjustments relate to the historical statement of income of ONI for the period from January 1, 2013 through August 8, 2013 derived from the unaudited special-purpose consolidated financial statements of Winreason prepared in accordance with the measurement and recognition criteria of IFRS, to which certain reclassification have been applied to conform to the presentation of the accompanying unaudited pro forma statements of income.

(e) Acquisition of Ma Chaîne Sport

On October 1, 2013, Altice International entered into a share purchase agreement with Altice IV S.A. and Valemi S.A. for the purchase of 100% of the share capital and voting rights of Ma Chaîne Sport S.A.S.. These pro- forma adjustments relate to the historical income statement of Ma Chaîne Sport for the period from January 1, 2013 through September 30, 2013 derived from the financial statements of Ma Chaîne Sport prepared in accordance with the measurement and recognition criteria of French Generally Accepted Accounting Principles (“French GAAP”).

The measurement and recognition criteria of French Generally Accepted Accounting Principles (“French GAAP”) do not permit the capitalisation of costs related to the acquisition of contents for delivery to final customers. Given the exclusive nature of such contents, IFRS allow the capitalisation and recognition of such costs as intangible assets. Had Ma Chaîne Sport adopted the aforementioned measurement and recognition criteria of IFRS, such illustrative adjustments result in a decrease in purchasing and subcontracting services of EUR 4.7 million, in other operating expenses of EUR 1.6 million and an increase in depreciation and amortization of EUR 6.1 million for the year ended December 31, 2013 and a decrease in purchasing and subcontracting services of EUR 4.1 million, in other operating expenses of EUR 1.4 million and an increase in depreciation and amortization of EUR 4.4 million for the nine months ended September 30, 2013.

(f) Acquisition of SportV

On October 1, 2013, Altice International obtained control over SportV S.A. These pro-forma adjustments relate to the historical income statement of SportV for the period from January 1, 2013 through December 31, 2013 derived from the financial statements of SportV prepared in accordance with the measurement and recognition criteria of IFRS, to which certain reclassification have been applied to conform to the presentation of the accompanying unaudited pro forma statements of income.

(g) Acquisition of non-controlling interests

Coditel

- (i) On November 29, 2013, Altice International purchased the remaining 40% of the shares and voting rights of Coditel Lux II S.à r.l. it did not hold and refinanced certain Preferred Equity Certificates issued by such entity. The cash consideration for the acquisition on a cash-free and debt-free basis was EUR 82.5 million. Pro-forma adjustments have hence been recorded to give effect to the impact on the non-controlling interests within the unaudited pro forma consolidated statement of income as if such transaction took place on January 1, 2013. Such adjustments represents the reallocation of the net income attributable to non-controlling interests to net income attributable to equity holders of the parent, as a result of the acquisition of the non-controlling interests for an amount of EUR 14.6 million for the nine month period ended September 30, 2013 and EUR 18.7 million for the full year ended December 31, 2013. Additionally, a reversal of EUR 7.2 million, pertaining to the interests paid on the preferred equity certificates for the period between January 1, 2013 and November 29, 2013, has been reflected in the unaudited pro-forma statement of financial income for the nine months ended September 30, 2013 and the twelve months ended December 31, 2013.

Cabovisao

- (ii) On April 23, 2013, Altice International purchased the remaining 40% of the shares and voting rights of Cabovisao. The cash consideration for the acquisition on a cash-free and debt-free basis was EUR 105.1 million. Pro-forma adjustments have hence been recorded to give effect to the impact on the non-controlling interests within the unaudited pro forma consolidated statement of income as if such transaction took place on January 1, 2013. Such adjustments represents the reallocation of the net income attributable to non-controlling interests to net income attributable to equity holders of the parent, as a result of the acquisition of the non-controlling interests for an amount of EUR 2.4 million for the nine months ended September 30, 2013 and twelve months ended December 31, 2013.

Outremer Telecom

- (iii) On June 27, 2014, Altice International repurchased the minority interests in Altice Blue Two S.A.S. it did not hold. Pro-forma adjustments have hence been recorded to give effect to the impact on the non-controlling interests within the unaudited pro forma consolidated income statement as if such transaction took place on January 1, 2013. Such adjustments represent the reallocation of the net income attributable to non-controlling interests to net income attributable to equity holders of the parent, as a result of the acquisition of the non-controlling interests for an amount of EUR 2.7 million for the full year ended December 31, 2013 and EUR 2.5 million for the nine months ended September 30, 2013.

(h) Refinancing Transactions

The Pro forma Adjustments relating to the refinancing transactions are composed as follows:

- (i) Issuance of Senior and Senior Secured Notes on June 14, 2013 and December 5, 2013

On June 14, 2013 and December 5, 2013, the Group issued Senior and Senior Secured Notes for an amount of EUR 1,505.0 million. The proceeds were used to refinance the following liabilities.

- The repayment of the Cabovisao credit facility on July 2, 2013 for an amount of EUR 202.6 million;
- The purchase of the Coditel Senior Facility on July 2, 2013 for an amount of EUR 42.3 million; and
- The purchase of Orange Dominicana for an amount of EUR 1,034.0 million and of Tricom and Global Interlink for EUR 299.2 million.
- The payment of transaction fees for a total amount of EUR 7.0 million.

- (ii) Use of Term Loan

On June 24, 2013, the Altice International Group secured a senior secured credit facility of EUR795 million. The proceeds were used to acquire ONI together with OMT and the rest was used to refinance the following liabilities:

- The repayment of the Coditel Senior Facility on July 2, 2013 for an amount of EUR 95.7 million;
- The repayment of the ONI credit facility on August 8, 2013 for an amount of EUR 47.3 million; and
- The repayment of the ABO credit facility on July 2, 2013 for an amount of EUR 65.6 million.

- (iii) Refinancing of Coditel mezzanine

On December 2, 2014, the Company, through its indirectly held subsidiary, Coditel Holding S.A., exercised a call option held on a mezzanine facility issued by Coditel Holding S.A.. The total amount refinanced was EUR 125.7 million, which included accumulated PIK interest and break costs of 6.75% of the nominal amount. This facility was refinanced by drawing on two RCFs currently available to the Group.

Pro-forma adjustments of EUR (6.9) million, EUR 58.7 and EUR 147.9 million have been recorded to reflect the net change to finance costs on borrowings for the nine months ended September 30, 2014 and September 30, 2013 and the year ended December 31, 2013, inclusive of tax effects, that would have been recorded had the above refinancing transactions taken place on January 1, 2013.

- (i) Translation of historical financial information denominated in currencies other than Euro.

The historical financial statements of ODO, from which amounts have been derived in preparing the Unaudited Pro Forma Financial Information as of and for the year ended December 31, 2013 and the nine months ended September 30, 2013, have been drawn in Dominican Pesos (“DOP”). The amounts have been translated into Euro (“EUR”), for the purposes of their inclusion within the Unaudited Pro Forma Financial Information, using the following rates.

- As of September 30, 2013: DOP1.00 = EUR0.0186
- As of December 31, 2013: DOP1.00 = EUR0.0168

- (j) Elimination of intercompany transactions between PT Portugal and Altice International S.à r.l. and its subsidiaries.

- (i) Intercompany transactions between the entities included in the Unaudited Pro Forma Financial Information have not been excluded or eliminated from the Unaudited Pro Forma Financial Information as the amounts were not considered material by the Board of Managers, except for certain transactions between Cabovisao S.A, ONI SGPS and PT Portugal and its subsidiaries that make up the transaction perimeter. These intercompany transactions had a zero net impact that has been recorded in the Unaudited pro-forma consolidated statements of income for the nine month periods ended September 30, 2013 and 2014 and for the full year ended December 31, 2013.
- (ii) Intercompany sales between Cabovisao and ONI and PT Portugal have been eliminated for an amount of EUR 17.6 million, EUR 24.3 million and EUR 30.6 million respectively for the nine months ended September 30, 2014 and 2013 and the twelve months ended December 31, 2013.
- (iii) Intercompany operating expenses and purchase and subcontracting services between Cabovisao and ONI and PT Portugal have been eliminated for an amount of EUR 17.6 million, EUR 24.3 million and EUR 30.6 million respectively have been eliminated for the nine months ended September 30, 2014 and 2013 and the twelve months ended December 31, 2013.
- (iv) The elimination of intercompany transactions between Cabovisao and ONI and PT Portugal relating to trade receivables and payables for EUR 9.0 million that have been recorded in the unaudited pro forma consolidated statement of financial position as at September 30, 2014.

4—Notes to the unaudited pro forma consolidated financial information

(a) Revenue Pre-PT Transaction

for the period ended September 30, 2014	Israel Total	BeLux Total Jan 1, 2014 to Sep 30, 2014	ODO Jan 1, 2014 to April 9, 2014	ODO April 9, 2014 to Sep 30, 2014	Dominican Republic Jan 1, 2014 To Sep 30, 2014	Portugal Total Jan 1, 2014 to Sep 30, 2014	French Overseas Territories Total Jan 1, 2014 to Sep 30, 2014	Other Jan 1, 2014 to Sep 30, 2014	Total Jan 1, 2014 to Sep 30, 2014
	Jan 1, 2014 to Sep 30, 2014	EUR	EUR	EUR	EUR	EUR	EUR	EUR	EUR
Cable based services.....	513.1	45.9	—	—	—	75.3	68.1	19.6	728.3
Mobile services.....	132.8	1.0	108.8	218.6	327.4	—	97.4	8.0	573.4
B2B & Others.....	—	7.1	—	—	—	65.1	13.2	107.7	179.9
Total.....	645.9	54.0	108.8	218.6	327.4	140.4	178.7	135.2	1,481.6

for the period ended September 30, 2013	Israel Total Jan 1, 2013 to Sep 30, 2013	BeLux Total Jan 1, 2013 to Sep 30, 2013	Dominican Republic Jan 1, 2013 to Sep 30, 2013	Cabovisao Jan 1, 2013 to Sep 30, 2013	ONI Aug 1, 2013 to Sep 30, 2013	ONI Jan 1, 2013 to July 31 2013	Portugal Total Jan 1, 2013 to Sep 30, 2013	Le Cable Jan 1, 2013 to Sep 30, 2013	OMT July 1, 2013 to Sep 30, 2013	OMT Jan 1, 2013 to Jun 30, 2013	French Overseas Territories Total Jan 1, 2013 to Sep 30, 2013	Other Jan 1, 2013 to Sep 30, 2013	Total Jan 1, 2013 to Sep 30, 2013
	EUR	EUR	EUR	EUR	EUR	EUR	EUR	EUR	EUR	EUR	EUR	EUR	EUR
Cable based services	527.0	45.7	—	83.4	—	—	83.4	18.7	15.0	30.0	63.7	1.3	721.1
Mobile services	142.4	0.8	333.9	—	—	—	—	—	36.1	66.6	102.6	—	579.7
B2B & Others.....	—	6.7	—	—	17.5	59.0	76.4	—	—	—	—	52.1	135.2
Total	669.4	53.2	333.9	83.4	17.5	59.0	159.9	18.7	51.1	96.5	166.3	53.4	1,436.1

4—Notes to the unaudited pro forma consolidated financial information (Continued)

(b) Revenue Pre-PT/ODO Transactions

	Israel Total Jan 1, 2013 to Dec 31, 2013	BeLux Total Jan 1, 2013 to Dec 31, 2013	Cabovisao Jan 1, 2013 to Dec 31, 2013	ONI Aug 1, 2013 to Dec 31, 2013	ONI Jan 1, 2013 to July 31 2013	Portugal Total Jan 1, 2013 to Dec 31, 2013	Le Cable Jan 1, 2013 to Dec 31, 2013	OMT Jan 1, 2013 to Dec 31, 2013	OMT Jan 1, 2013 to Dec 31, 2013	French Overseas Territories Total Jan 1, 2013 to Dec 31, 2013	Other Jan 1, 2013 to Dec 31, 2013	Total Jan 1, 2013 to Dec 31, 2013
for the year ended December 31, 2013	EUR	EUR	EUR	EUR	EUR	EUR	EUR	EUR	EUR	EUR	EUR	EUR
Cable based services.....	694.2	60.9	108.7	—	—	108.7	24.9	34.8	30.0	89.6	1.3	954.7
Mobile services.....	187.6	1.2	—	—	—	—	—	67.3	66.6	133.9	—	322.8
B2B & Others.....	—	8.4	—	41.9	59.0	100.9	—	—	—	—	73.9	183.1
Total.....	<u>881.9</u>	<u>70.5</u>	<u>108.7</u>	<u>41.9</u>	<u>59.0</u>	<u>209.6</u>	<u>24.9</u>	<u>102.1</u>	<u>96.5</u>	<u>223.5</u>	<u>75.2</u>	<u>1,460.6</u>

4—Notes to the unaudited pro forma financial information (Continued)

(c) Purchases and subcontracting services Pre-PT Transaction

	Israel	BeLux	ODO	ODO	Dominican	Portugal	French	Other	Total Jan
for the period ended	Total Jan	Total	Jan 1,	Apr 1,	Republic Jan	Total Jan	Overseas	Jan 1,	Total Jan
September 30, 2014	1, 2014 to	Jan 1,	Jan 1,	2014 to	1, 2014 to	1, 2014 to	Territories	2014 to	1, 2014 to
	Sep 30,	2014 to	Mar 31,	Sep 30,	Sep 30, 2014	Sep 30,	Total Jan 1,	Sep 30,	Sep 30,
	2014	2014	2014	2014		2014	2014 to Sep	2014	2014
	EUR	EUR	EUR	EUR	EUR	EUR	EUR	EUR	EUR
Cable based services.....	(86.5)	(7.4)	—	—	—	(23.3)	(12.5)	(14.1)	(143.8)
Mobile services.....	(42.1)	(1.2)	(27.4)	(48.8)	(76.2)	—	(26.2)	(2.2)	(147.9)
B2B & Others.....	—	(0.3)	—	—	—	(36.9)	(4.0)	(19.0)	(60.2)
Total.....	(128.7)	(8.8)	(27.4)	(48.8)	(76.2)	(60.2)	(42.7)	(35.4)	(351.9)

4—Notes to the unaudited pro forma consolidated financial information (Continued)

	Israel Total Jan 1, 2013 to Sep 30, 2013	BeLux Total Jan 1, 2013 to Sep 30, 2013	Dominican Republic Jan 1, 2013 to Sep 30, 2013	Cabovisao Jan 1, 2013 to Sep 30, 2013	ONI Aug 1, 2013 to Sep 30, 2013	ONI Jan 1, 2013 to July 31 2013	Portugal Total Jan 1, 2013 to Sep 30, 2013	Le Cable Jan 1, 2013 to Sep 30, 2013	OMT July 1, 2013 to Sep 30, 2013	OMT Jan 1, 2013 to Jun 30, 2013	French Overseas Territories Total Jan 1, 2013 to Sep 30, 2013	Other Jan 1, 2013 to Sep 30, 2013	Total Jan 1, 2013 to Sep 30, 2013
for the period ended September 30, 2013	EUR	EUR	EUR	EUR	EUR	EUR	EUR	EUR	EUR	EUR	EUR	EUR	EUR
Cable based services.....	(101.6)	(7.2)	—	(26.2)	—	—	(26.2)	(2.6)	(5.0)	(9.6)	(17.2)	(0.3)	(152.4)
Mobile services.....	(82.8)	(0.7)	(101.5)	—	—	—	—	—	(11.1)	(20.5)	(31.6)	—	(216.3)
B2B & Others.....	—	(1.3)	—	—	(10.3)	(31.2)	(41.5)	—	—	—	—	(18.1)	(60.8)
Total.....	(184.4)	(9.1)	(101.5)	(26.2)	(10.3)	(31.2)	(67.7)	(2.6)	(16.1)	(30.1)	(48.8)	(18.4)	(429.7)

4—Notes to the unaudited pro forma consolidated financial information (Continued)

(d) Purchases and subcontracting services Pre-PT/ODO

	Israel Total Jan 1, 2013 to Dec 31, 2013	BeLux Total Jan 1, 2013 to Dec 31, 2013	Cabovisao Jan 1, 2013 to Dec 31, 2013	ONI Aug 1, 2013 to Dec 31, 2013	ONI Jan 1, 2013 to July 31 2013	Portugal Total Jan 1, 2013 to Dec 31, 2013	Le Cable Jan 1, 2013 to Dec 31, 2013	OMT July 1, 2013 to Dec 31, 2013	OMT Jan 1, 2013 to Jun 30, 2013	French Overseas Territories Total Jan 1, 2013 to Dec 31, 2013	Other Jan 1, 2013 to Dec 31, 2013	Total Jan 1, 2013 to Dec 31, 2013
for the year ended December 31, 2013	EUR	EUR	EUR	EUR	EUR	EUR	EUR	EUR	EUR	EUR	EUR	EUR
Cable based services	(129.6)	(10.6)	(34.1)	—	—	(34.1)	(11.6)	(9.6)	(3.9)	(25.1)	(0.3)	(199.7)
Mobile services	(107.8)	(0.9)	—	—	—	—	(21.2)	(20.5)	—	(41.7)	—	(150.4)
B2B & Others	—	(1.0)	—	(24.5)	(31.2)	(55.5)	—	—	—	—	(26.8)	(83.4)
Total	<u>(237.4)</u>	<u>(12.6)</u>	<u>(34.1)</u>	<u>(24.5)</u>	<u>(31.2)</u>	<u>(89.6)</u>	<u>(32.8)</u>	<u>(30.1)</u>	<u>(3.9)</u>	<u>(66.8)</u>	<u>(27.1)</u>	<u>(433.6)</u>

4—Notes to the unaudited pro forma consolidated financial information (Continued)

(e) Gross Profit Pre-PT Transaction

for the period September 30, 2014	BeLux Total		ODO Jan 1, 2014 to Apr 9, 2014	ODO Apr 9, 2014 to Sep 30, 2014	Dominican Republic Jan 1, 2014 To Sep 30, 2014	Portugal Total Jan 1, 2014 to Sep 30, 2014	French Overseas Territories Total Jan 1, 2014 to Sep 30, 2014	Other Jan 1, 2014 to Sep 30, 2014	Total Jan 1, 2014 to Sep 30, 2014
	Israel Total Jan 1, 2014 to Sep 30, 2014	Jan 1, 2014 to Sep 30, 2014							
	EUR	EUR	EUR	EUR	EUR	EUR	EUR	EUR	EUR
Cable based services.....	426.5	38.5	—	—	—	52.0	64.8	5.5	587.4
Mobile services.....	90.7	(0.1)	81.4	169.8	251.2	—	71.2	5.7	418.7
B2B & Others.....	—	6.8	—	—	—	28.2	0.0	88.6	123.6
Total.....	517.2	45.2	81.4	169.8	251.2	80.2	136.1	99.8	1,129.7

4—Notes to the unaudited pro forma consolidated financial information (Continued)

	Israel Total Jan 1, 2013 to Sep 30, 2013	BeLux Total Jan 1, 2013 to Sep 30, 2013	Dominican Republic Jan 1, 2013 to Sep 30, 2013	Cabovisao Jan 1, 2013 to Sep 30, 2013	ONI Aug 1, 2013 to Sep 30, 2013	ONI Jan 1, 2013 to July 31 2013	Portugal Total Jan 1, 2013 to Sep 30, 2013	Le Cable Jan 1, 2013 to Sep 30, 2013	OMT July 1, 2013 to Sep 30, 2013	OMT Jan 1, 2013 to Jun 30, 2013	French Overseas Territories Total Jan 1, 2013 to Sep 30, 2013	Other Jan 1, 2013 to Sep 30, 2013	Total Jan 1, 2013 to Sep 30, 2013
for the period ended September 30, 2013	EUR	EUR	EUR	EUR	EUR	EUR	EUR	EUR	EUR	EUR	EUR	EUR	EUR
Cable based services	425.4	38.5	—	57.3	—	—	57.3	16.1	10.0	20.4	46.5	1.0	568.6
Mobile services	59.6	0.1	232.5	—	—	—	—	—	25.0	46.1	71.0	—	363.5
B2B & Others	—	5.4	—	—	7.2	27.7	35.1	—	—	—	—	34.1	74.5
Total	485.0	44.1	232.5	57.3	7.2	27.7	92.3	16.1	34.9	66.4	117.5	35.1	1,006.7

4—Notes to the unaudited pro forma consolidated financial information (Continued)

(f) Gross Profit Pre-PT/ODO Transactions

	Israel Total Jan 1, 2013 to Dec 31, 2013	BeLux Total Jan 1, 2013 to Dec 31, 2013	Cabovisao Jan 1, 2013 to Dec 31, 2013	ONI Aug 1, 2013 to Dec 31, 2013	ONI Jan 1, 2013 to July 31 2013	Portugal Total Jan 1, 2013 to Dec 31, 2013	Le Cable Jan 1, 2013 to Dec 31, 2013	OMT July 1, 2013 to Dec 31, 2013	OMT Jan 1, 2013 to Jun 30, 2013	French Overseas Territories Total Jan 1, 2013 to Dec 31, 2013	Other Jan 1, 2013 to Dec 31, 2013	Total Jan 1, 2013 to Dec 31, 2013
for the year ended December 31, 2013	EUR	EUR	EUR	EUR	EUR	EUR	EUR	EUR	EUR	EUR	EUR	EUR
Cable based services.....	564.6	50.2	74.5	—	—	74.5	21.0	23.1	20.4	64.5	1.0	754.9
Mobile services	79.9	0.3	—	—	—	—	—	46.2	46.1	92.2	—	172.4
B2B & Others.....	—	7.3	—	17.5	27.8	45.3	—	—	—	—	47.1	99.7
Total.....	644.5	57.9	74.5	17.5	27.8	119.8	21.0	69.3	66.5	156.7	48.1	1,027.0

4—Notes to the unaudited pro forma consolidated financial information (Continued)

(g) Other expenses Pre-PT

for the period September 30, 2014	Israel Total	BeLux	ODO Jan	ODO	Dominican	Portugal	French Overseas	Other Jan	Total Jan
	Jan 1, 2014 to Sep 30, 2014	Total Jan 1, 2014 to Sep 30, 2014	1, 2014 to Apr 9, 2014	Apr 9, 2014 to Sep 30, 2014	Republic Jan 1, 2014 To Sep 30, 2014	Total Jan 1, 2014 to Sep 30, 2014	Territories Total Jan 1, 2014 to Sep 30, 2014	1, 2014 to Sep 30, 2014	1, 2014 to Sep 30, 2014
	EUR	EUR	EUR	EUR	EUR	EUR	EUR	EUR	EUR
Other operating expenses.....	(142.5)	(4.1)	(10.3)	(24.2)	(34.5)	(21.2)	(40.8)	(13.4)	(256.6)
Other sales and marketing expenses.....	(38.3)	(1.9)	(19.0)	(39.4)	(58.4)	(7.6)	(12.1)	(6.6)	(124.9)
General and administrative expenses	(21.7)	(2.8)	(6.7)	(1.8)	(8.5)	(7.2)	(10.4)	(25.2)	(75.8)
Total	(202.6)	(8.9)	(36.0)	(65.3)	(101.3)	(35.9)	(63.4)	(45.2)	(457.4)

4—Notes to the unaudited pro forma consolidated financial information (Continued)

	Israel Total Jan 1, 2013 to Sep 30, 2013	BeLux Total Jan 1, 2013 to Sep 30, 2013	Dominican Republic Jan 1, 2013 to Sep 30, 2013	Cabovisao Jan 1, 2013 to Sep 30, 2013	ONI Aug 1, 2013 to Sep 30, 2013	ONI Jan 1, 2013 to July 31 2013	Portugal Total Jan 1, 2013 to Sep 30, 2013	Le Cable Jan 1, 2013 to Sep 30, 2013	OMT July 1, 2013 to Sep 30, 2013	OMT Jan 1, 2013 to Jun 30, 2013	French Overseas Territories Total Jan 1, 2013 to Sep 30, 2013	Other Jan 1, 2013 to Sep 30, 2013	Total Jan 1, 2013 to Sep 30, 2013
for the period ended September 30, 2013	EUR	EUR	EUR	EUR	EUR	EUR	EUR	EUR	EUR	EUR	EUR	EUR	EUR
Other operating expenses	(157.9)	(2.7)	(24.7)	(14.8)	(3.4)	(11.2)	(29.5)	(2.3)	(10.1)	(19.8)	(32.2)	(4.9)	(251.9)
Other sales and marketing expenses	(36.4)	(1.2)	(42.3)	(5.5)	(0.4)	(1.3)	(7.3)	(0.9)	(3.0)	(7.3)	(11.1)	(3.6)	(101.9)
General and administrative expenses	(20.8)	(4.8)	(33.7)	(3.1)	(1.4)	(5.9)	(10.5)	(2.6)	(3.4)	(6.1)	(12.1)	(9.3)	(91.2)
Total	(215.1)	(8.6)	(100.7)	(23.5)	(5.2)	(18.4)	(47.2)	(5.8)	(16.4)	(33.2)	(55.5)	(17.8)	(444.9)

4—Notes to the unaudited pro forma consolidated financial information (Continued)

(h) Other expenses Pre-PT/ODO Transactions

for the period ended December 31, 2013	Israel	BeLux	Cabovisao Jan 1, 2013 to Dec 31, 2013	ONI	ONI	Portugal	Le	OMT	OMT	French	Other	Total
	Total Jan 1, 2013 to Dec 31, 2013	Total Jan 1, 2013 to Dec 31, 2013		Aug 1 2013 to Dec 31, 2013	Jan 1, 2013 to July 31, 2013	Total Jan 1, 2013 to Dec 31, 2013	Cable Jan 1, 2013 to Dec 31, 2013	July 1, 2013 to Dec 31, 2013	Jan 1, 2013 to Jun 30, 2013	Overseas Territories Total Jan 1, 2013 to Dec 31, 2013	Jan 1, 2013 to Dec 31, 2013	Jan 1, 2013 to Dec 31, 2013
	EUR	EUR	EUR	EUR	EUR	EUR	EUR	EUR	EUR	EUR	EUR	EUR
Other operating expenses	(204.1)	(5.4)	(19.6)	(7.8)	(11.2)	(38.6)	(3.9)	(14.5)	(19.8)	(38.2)	(6.9)	(293.1)
Other sales and marketing expenses	(49.9)	(3.4)	(7.6)	(1.1)	(1.3)	(10.0)	(0.5)	(12.2)	(7.3)	(20.0)	(4.6)	(87.9)
General and administrative expenses	(27.5)	(4.1)	(4.0)	(3.0)	(5.9)	(13.0)	(2.7)	(5.2)	(6.1)	(14.0)	(16.0)	(74.6)
Total	(281.5)	(12.9)	(31.2)	(11.8)	(18.4)	(61.5)	(7.1)	(31.9)	(33.2)	(72.2)	(27.5)	(455.8)

4—Notes to the unaudited pro forma consolidated financial information (Continued)

(i) Operating profit before depreciation, amortization, other expenses and non recurring expenses Pre-PT Transactions

	Israel Total Jan 1, 2014 to Sep 30, 2014	BeLux Total Jan 1, 2014 to Sep 30, 2014	ODO Jan 1, 2014 to April 9, 2014	ODO April 9, 2014 to Sep 30, 2014	Dominican Republic Jan 1, 2014 To Sep 30, 2014	Portugal Total Jan 1, 2014 to Sep 30, 2014	French Overseas Territories Total Jan 1, 2014 to Sep 30, 2014	Other Jan 1, 2014 to Sep 30, 2014	Total Jan 1, 2014 to Sep 30, 2014
for the period September 30, 2014	EUR	EUR	EUR	EUR	EUR	EUR	EUR	EUR	EUR
EBITDA	314.6	36.3	45.5	104.5	150.0	44.3	72.7	54.6	672.3

	Israel Total Jan 1, 2013 to Sep 30, 2013	BeLux Total Jan 1, 2013 to Sep 30, 2013	Dominican Republic Jan 1, 2013 to Sep 30, 2013	Cabovisao Jan 1, 2013 to Sep 30, 2013	ONI Aug 1, 2013 to Sep 30, 2013	ONI Jan 1, 2013 to July 31 2013	Portugal Total Jan 1, 2013 to Sep 30, 2013	Le Cable Jan 1, 2013 to Sep 30, 2013	OMT July 1, 2013 to Sep 30, 2013	OMT Jan 1, 2013 to Jun 30, 2013	French Overseas Territories Total Jan 1, 2013 to Sep 30, 2013	Other Jan 1, 2013 to Sep 30, 2013	Total Jan 1, 2013 to Sep 30, 2013
for the period ended September 30, 2013	EUR	EUR	EUR	EUR	EUR	EUR	EUR	EUR	EUR	EUR	EUR	EUR	
EBITDA	269.9	35.4	131.7	33.7	2.0	9.2	45.1	10.3	18.5	33.2	62.1	17.7	561.5

4—Notes to the unaudited pro forma consolidated financial information (Continued)

(j) Operating income before depreciation and amortization, other expenses and non recurring expenses Pre-PT/ODO Transactions

	Israel Jan 1, 2013 to Dec 31, 2013	BeLux Jan 1, 2013 to Dec 31, 2013	Cabovisao Jan 1, 2013 to Dec 31, 2013	ONI Aug 1 2013 to Dec 31, 2013	ONI Jan 1, 2013 to July 30, 2013	Portugal TOTAL Jan 1, 2013 to Dec 31, 2013	Le Cable Jan 1, 2013 to Dec 31, 2013	OMT July 1, 2013 to Dec 31, 2013	OMT Jan 1, 2013 to Jun 30, 2013	French Overseas Territories Jan 1, 2013 to Dec 31, 2013	Other Jan 1, 2013 to Dec 31, 2013	Total Jan 1, 2013 to Dec 31, 2013
	EUR	EUR	EUR	EUR	EUR	EUR	EUR	EUR	EUR	EUR	EUR	EUR
For the year ended December 31, 2013	363.0	45.0	43.3	5.7	9.4	58.3	13.9	37.4	33.3	84.6	20.0	570.9

(k) Capital expenditures Pre-PT Transaction

	Pre-Transaction Pro Forma Financial Information											
	For the nine months ended September 30, 2014							For the nine months				
	Israel	Belgium and Luxembourg	Dominican Republic	Portugal	French Overseas Territories	Others	Total	Israel	Belgium and Luxembourg	Dominican Republic		
	€ in millions											
Capital expenditures												
Cable based services	133.0	12.0		8.1		22.8	10.0	185.9	100.0		13.5	—
Mobile services.....	22.8	—	48.4	—		12.3	—	83.5	36.0		1.2	38.9
B2B and others	—	2.3	—	10.0		0.3	33.1	45.6	—		—	—
Total capital expenditures ...	155.8	14.3	48.4	18.1		35.4	43.1	315.1	136.0		14.7	38.9
EBITDA—total capital expenditures	158.8	22.1	101.6	26.2		37.3	11.5	357.4	133.9		20.7	92.8

4—Notes to the unaudited pro forma consolidated financial information (Continued)

(l) Capital expenditures Pre-PT/ODO Transactions

for the year ended December 31, 2013	For the year ended December 31, 2013									
	Israel	Belgium and	Cabovisao	Oni	Portugal	OMT	Le cable	French Overseas	Others	Total
	Total	Luxembourg			Total			Territories Total		
EUR	EUR	EUR	EUR	EUR	EUR	EUR	EUR	EUR	EUR	EUR
Cable based services.....	155.3	21.5	18.3	—	18.3	5.1	4.4	9.5	0.3	204.8
Mobile services	53.6	—	—	—	—	8.3	—	8.3	—	61.9
B2B & Others.....	—	1.4	—	5.7	5.7	17.4	1.1	18.5	21.8	47.3
Total capital expenditures.....	208.9	23.0	18.3	5.7	24.0	30.7	5.5	36.2	22.1	314.2

4—Notes to the unaudited pro forma consolidated financial information (Continued)

(m) Revenue Post Transaction

	Israel Total Jan 1, 2014 to Sep 30, 2014	BeLux Total Jan 1, 2014 to Sep 30, 2014	ODO Jan 1, 2014 to Mar 31, 2014	ODO Apr 1, 2014 to Sep 30, 2014	Dominican Republic Jan 1, 2014 To Sep 30, 2014	Portugal Jan 1, 2014 to Sep 30, 2014	PT Portugal Jan 1, 2014 to Sep 30, 2014	French Overseas Territories Total Jan 1, 2014 to Sep 30, 2014	Other Jan 1, 2014 to Sep 30, 2014	Adj*	Total Jan 1, 2014 to Sep 30, 2014
for the period September 30, 2014	EUR	EUR	EUR	EUR	EUR	EUR	EUR	EUR	EUR	EUR	EUR
Revenue	645.9	54.0	108.8	218.6	327.4	140.4	1,900.9	178.7	135.2	(17.6)	3,365.0

	Israel Total Jan 1, 2013 to Sep 30, 2013	BeLux Total Jan 1, 2013 to Sep 30, 2013	Dominican Republic Jan 1, 2013 to Sep 30, 2013	Cabovisao Jan 1, 2013 to Sep 30, 2013	ONI Aug 1, 2013 to Sep 30, 2013	ONI Jan 1, 2013 to July 31 2013	Portugal Total Jan 1, 2013 to Sep 30, 2013	PT Portugal Total Jan 1, 2013 to Sep 30, 2013	Le Cable Jan 1, 2013 to Sep 30, 2013	OMT Jan 1, 2013 to Sep 30, 2013	OMT Jan 1, 2013 to Jun 30, 2013	French Overseas Territories Total Jan 1, 2013 to Sep 30, 2013	Other Jan 1, 2013 to Sep 30, 2013	Adj*	Total Jan 1, 2013 to Sep 30, 2013
for the period ended September 30, 2013	EUR	EUR	EUR	EUR	EUR	EUR	EUR	EUR	EUR	EUR	EUR	EUR	EUR	EUR	EUR
Revenue	669.4	53.1	333.9	83.4	17.5	59.0	159.8	1,963.2	18.7	51.1	96.5	166.3	53.4	(24.3)	3,375.0

4—Notes to the unaudited pro forma consolidated financial information (Continued)

(n) Revenue Post Acquisition

Israel	Cabovisao	ONI	ONI	PT Portugal	Belgium & Luxembourg	Le Cable	OMT	OMT	Total French Overseas Territories	Dominican Republic	Others	Adj. (*)	Total
Jan 1, 2013 to Dec 31, 2013	Jan 1, 2013 to Dec 31, 2013	Jan 1, 2013 to July 31, 2013	Aug 1, 2013 to Dec 31, 2013	Jan 1, 2013 To Dec 31, 2013	Jan 1, 2013 to Dec 31, 2013	Jan 1, 2013 to Dec 31, 2013	Jan 1, 2013 to Jun 30, 2013	Jul 1, 2013 to Dec 31, 2013		Jan 1, 2013 to Dec 31, 2013	Jan 1, 2013 to Dec 31, 2013	Jan 1, 2013 to Dec 31, 2013	Jan 1, 2013 to Dec 31, 2013
881.9	108.7	59.0	41.9	2,627.4	70.5	24.9	96.5	102.1	223.5	446.3	75.2	(30.6)	4,503.6

(*) Adjustments refer to the elimination of intercompany transactions between the Alice International Group and the PT Portugal Group. Please see section 3 for more details.

4—Notes to the unaudited pro forma consolidated financial information (Continued)

(o) Operating income before depreciation and amortization, other expenses and non recurring expenses Post Transaction

Israel Total Jan 1, 2014 to Sep 30, 2014	BeLux Total Jan 1, 2014 to Sep 30, 2014	ODO Jan 1, 2014 to April 9, 2014	ODO April 9, 2014 to Sep 30, 2014	Dominican Republic Jan 1, 2014 To Sep 30, 2014	Portugal Jan 1, 2014 to Sep 30, 2014	PT Portugal Jan 1, 2014 to Sep 30, 2014	French Overseas Territories Total Jan 1, 2014 to Sep 30, 2014	Other Jan 1, 2014 to Sep 30, 2014	Total Jan 1, 2014 to Sep 30, 2014
EUR	EUR	EUR	EUR	EUR	EUR	EUR	EUR	EUR	EUR
314.6	36.3	45.5	104.5	150.0	44.3	746.6	72.7	54.6	1,418.9

Israel Total Jan 1, 2013 to Sep 30, 2013	BeLux Total Jan 1, 2013 to Sep 30, 2013	Dominican Republic Jan 1, 2013 to Sep 30, 2013	Cabovisao Jan 1, 2013 to Sep 30, 2013	ONI Aug 1, 2013 to Sep 30, 2013	ONI Jan 1, 2013 to July 31 2013	Portugal Total Jan 1, 2013 to Sep 30, 2013	PT Portugal Total Jan 1, 2013 to Sep 30, 2013	Le Cable Jan 1, 2013 to Sep 30, 2013	OMT July 1, 2013 to Sep 30, 2013	OMT Jan 1, 2013 to Jun 30, 2013	French Overseas Territories Total Jan 1, 2013 to Sep 30, 2013	Other Jan 1, 2013 to Sep 30, 2013	Total Jan 1, 2013 to Sep 30, 2013
EUR	EUR	EUR	EUR	EUR	EUR	EUR	EUR	EUR	EUR	EUR	EUR	EUR	EUR
269.9	35.4	131.7	33.8	2.0	9.4	45.1	775.7	10.3	18.5	33.2	62.0	17.3	1,337.2

4—Notes to the unaudited pro forma consolidated financial information (Continued)

(p) Operating income before depreciation and amortization, other expenses and non recurring expenses Post transaction

Israel	Cabovisao	ONI	ONI	Total Portugal	Portugal* (PT Portugal)	Belgium & Luxembourg	Le Cable	OMT	OMT	Total French Overseas Territories	Dominican Republic	Others	Adjustments (*)	Total
Jan 1, 2013 to Dec 31, 2013	Jan 1, 2013 to Dec 31, 2013	Jan 1, 2013 to July 31, 2013	Aug 1, 2013 to Dec 31, 2013	Jan 1, 2013 to Dec 31, 2013	Jan 1, 2013 to Dec 31, 2013	Jan 1, 2013 to Dec 31, 2013	Jan 1, 2013 to Dec 31, 2013	Jan 1, 2013 to Jun 30, 2013	Jul 1, 2013 to Dec 31, 2013	Jan 1, 2013 to Dec 31, 2013	Jan 1, 2013 to Dec 31, 2013	Jan 1, 2013 to Dec 31, 2013	Jan 1, 2013 to Dec 31, 2013	Jan 1, 2013 to Dec 31, 2013
363.0	43.3	9.4	5.7	58.2	1,026.4	45.0	13.9	33.3	37.4	84.6	173.0	20.0	(1.6)	1,770.7

4—Notes to the unaudited pro forma consolidated financial information (Continued)

(q) Capital expenditure Post Transaction

Israel Total Jan 1, 2014 to Sep 30, 2014	BeLux Total Jan 1, 2014 to Sep 30, 2014	Dominican Republic Jan 1, 2014 To Sep 30, 2014	Portugal Jan 1, 2014 to Sep 30, 2014	Portugal *(PT Portugal) Jan 1, 2014 to Sep 30, 2014	French Overseas Territories Total Jan 1, 2014 to Sep 30, 2014	Other Jan 1, 2014 to Sep 30, 2014	Total Jan 1, 2014 to Sep 30, 2014
EUR	EUR	EUR	EUR	EUR	EUR	EUR	EUR
155.8	14.3	48.4	18.1	316.4	35.4	43.1	631.5

Israel Total Jan 1, 2013 to Sep 30, 2013	BeLux Total Jan 1, 2013 to Sep 30, 2013	Dominican Republic Jan 1, 2013 to Sep 30, 2013	Portugal Total Jan 1, 2013 to Sep 30, 2013	Portugal *(PT Portugal) Jan 1, 2013 to Sep 30, 2013	French Overseas Territories Total Jan 1, 2013 to Sep 30, 2013	Other Jan 1, 2013 to Sep 30, 2013	Total Jan 1, 2013 to Sep 30, 2013
EUR	EUR	EUR	EUR	EUR	EUR	EUR	EUR
136.0	14.7	38.9	18.3	428.1	27.1	13.4	676.5

4—Notes to the unaudited condensed combined financial information (Continued)

(r) Capital expenditure Post Transaction

Israel	Cabovisao	ONI	ONI	Total Portugal	PT Portugal	Belgium & Luxembourg	Le Cable	OMT	OMT	Total French Overseas Territories
Jan 1, 2013 to Dec 31, 2013	Jan 1, 2013 to Dec 31, 2013	Jan 1, 2013 to July 31, 2013	Aug 1, 2013 to Dec 31, 2013	Jan 1, 2013 to Dec 31, 2013	Jan 1, 2013 to Dec 31, 2013	Jan 1, 2013 to Dec 31, 2013	Jan 1, 2013 to Dec 31, 2013	Jan 1, 2013 to Jun 30, 2013	Jul 1, 2013 to Dec 31, 2013	Jan 1, 2013 to Dec 31, 2013
208.9	18.3	3.6	2.1	24.0	560.0	23.0	5.5	14.7	16.0	36.0

5—Other Information

Other referenced acquisitions and divestitures as disclosed in the “Presentation of Financial Information” have not been reflected in the pro forma adjustments. The other referenced acquisitions and divestitures were not individually or in the aggregate significant to the Company.

The tax effect of the transaction adjustments in the Unaudited Pro Forma Financial Information has been calculated using a theoretical effective tax rate of 38% for companies based in France, 29.22% for companies based in Luxembourg and 23% for companies based in Portugal, for the nine month period ended September 30, 2014.

PT PORTUGAL UNAUDITED COMBINED ADJUSTED FINANCIAL INFORMATION

The unaudited combined adjusted financial information presented below represents PT target assets (“Combined Adjusted Financial Information”) (as defined below), which includes (1) the unaudited combined balance sheet as of September 30, 2014, (2) the unaudited combined income and cash flow statements for the nine months ended September 30, 2014 and 2013 and for the year ended December 31, 2013, (3) the unaudited selected income and cash flow statement data for the years ended December 31, 2012 and 2011, and (4) the selected notes to the main captions of the unaudited combined adjusted balance sheet and income statements as of and for the nine month period ended September 30, 2014.

Combined Balance Sheet as of September 30, 2014 (Euro million)			Contribution from other entities	Eliminations and adjustments		Combined pre carve-out/in adjustments	Assets carve- out/in to adjust the perimeter	Combined after carve-out/in adjustments
	PTC Standalone	MEO Standalone		Between PTC and MEO	Between PTC/MEO and other entities			
ASSETS								
Current Assets								
Cash, cash equivalents and short-term investments	54.9	78.6	111.2	—	(0.0)	244.7	—	244.7
Accounts receivable, net	655.4	454.5	90.9	(306.7)	(19.7)	874.3	—	874.3
Inventories, net	31.8	19.4	24.4	—	—	75.5	—	75.5
Tax receivable	15.9	7.8	61.4	—	—	85.1	—	85.1
Other current assets	12.9	12.3	224.5	—	(1.3)	248.3	(200.0)	48.3
Non current assets held for sale	(0.0)	—	—	—	(0.0)	(0.0)	—	(0.0)
Total Current Assets	770.9	572.5	512.3	(306.7)	(21.1)	1,527.9	(200.0)	1,327.9
Non-Current Assets								
Investments in group and associated companies	7,037.1	4,923.3	1,777.9	(5,809.2)	(6,140.6)	1,788.6	(1,767.9)	20.7
Investments in intercompany loans	—	—	3,406.0	—	—	3,406.0	—	3,406.0
Other investments	22.8	—	0.1	—	—	22.9	—	22.9
Goodwill	2,982.4	10.2	1,255.7	—	(524.6)	3,723.7	—	3,723.7
Intangible assets	192.8	355.2	26.5	—	(0.0)	574.5	—	574.5
Fixed assets, net	2,534.7	424.6	150.3	—	(6.0)	3,103.7	—	3,103.7
Post retirement benefits	1.9	—	—	—	—	1.9	—	1.9
Deferred taxes	316.1	36.4	39.0	—	(0.0)	391.5	—	391.5
Other non-current assets	0.4	0.1	1.4	—	0.0	1.8	—	1.8
Total Non-Current Assets	13,088.2	5,749.8	6,657.0	(5,809.2)	(6,671.2)	13,014.6	(1,767.9)	11,246.7
Total Assets	13,859.1	6,322.2	7,169.3	(6,115.9)	(6,692.3)	14,542.5	(1,967.9)	12,574.5
LIABILITIES								
Current Liabilities								
Short term debt	15.9	1.4	460.3	—	—	477.6	—	477.6
Short term intercompany debt	—	—	1,340.2	—	—	1,340.2	—	1,340.2
Accounts payable	554.9	256.5	68.2	(278.6)	(122.7)	478.2	—	478.2
Accrued expenses	280.8	142.4	77.5	(28.1)	(127.5)	345.1	—	345.1
Deferred income	94.1	38.3	27.7	—	(1.1)	159.0	—	159.0
Tax payable	40.7	22.0	28.2	—	—	90.9	—	90.9
Provisions	25.3	16.6	8.0	—	—	49.9	—	49.9
Other liabilities	—	—	0.4	—	—	0.4	—	0.4
Total Current Liabilities	1,011.7	477.3	2,010.4	(306.7)	(251.3)	2,941.3	—	2,941.3
Non-Current liabilities								
Medium and long-term debt	11.4	1.6	863.9	—	(0.1)	876.8	—	876.8
Medium and long-term Intercompany debt	7,290.8	—	5,906.2	—	(6,337.4)	6,859.6	—	6,859.6
Accounts payable	—	9.9	9.0	—	0.1	19.0	—	19.0
Deferred income	—	—	0.0	—	0.0	0.0	—	0.0
Provisions	0.4	—	—	—	0.9	1.3	—	1.3
Post retirement benefits	1,065.6	5.2	2.9	—	0.0	1,073.6	—	1,073.6
Deferred taxes	141.5	(0.0)	0.0	—	—	141.5	—	141.5
Other liabilities	—	19.0	1.2	—	(1.2)	19.0	—	19.0
Total Non-Current Liabilities	8,509.7	35.8	6,783.0	—	(6,337.6)	8,990.8	—	8,990.8
Total Liabilities	9,521.4	513.1	8,793.4	(306.7)	(6,589.0)	11,932.1	—	11,932.1
Net Assets	4,337.7	5,809.2	(1,624.1)	(5,809.2)	(103.3)	2,610.4	(1,967.9)	642.5

Combined Income Statement for the nine months ended September 30, 2014 (Euro million)	Eliminations and adjustments		Contribution from other entities	Between PTC and MEO	Between PTC/MEO and other entities	Combined pre carve-out/in adjustments	Carve-out/in adjustments	COMBINED after carve-out/in adjustments
	PTC Standalone	MEO Standalone						
Operating Revenues	1,304.5	745.4	62.5	(200.1)	(11.4)	1,900.9	—	1,900.9
Services rendered.....	1,251.6	678.6	42.9	(178.9)	(4.6)	1,789.6	—	1,789.6
Sales.....	18.0	60.3	17.8	(9.8)	(0.2)	86.0	—	86.0
Other operating revenues.....	34.9	6.6	1.8	(11.3)	(6.6)	25.3	—	25.3
Costs from operations	884.5	455.0	263.3	(199.5)	(249.0)	1,154.4	—	1,154.4
Wages and salaries.....	144.4	30.9	95.6	—	(1.2)	269.6	—	269.6
Direct costs.....	372.2	151.6	0.1	(171.1)	(11.2)	341.5	—	341.5
Commercial costs:								
Costs of products sold.....	11.5	60.6	(0.2)	(9.6)	(0.0)	62.3	—	62.3
Commissions.....	44.5	46.6	3.9	(0.6)	(38.5)	55.9	—	55.9
Marketing and publicity.....	14.5	10.2	10.8	(0.1)	(0.1)	35.4	—	35.4
Support Services.....	146.3	67.3	67.8	(1.5)	(181.8)	98.1	—	98.1
Maintenance and repairs.....	46.5	17.6	9.5	(1.9)	(4.8)	66.9	—	66.9
Supplies and external services.....	81.6	52.8	61.3	(13.0)	(11.8)	170.9	—	170.9
Provisions and adjustments.....	11.3	(2.7)	(0.0)	—	—	8.6	—	8.6
Taxes.....	12.0	13.5	3.5	(0.5)	0.5	29.1	—	29.1
Other operating costs.....	(0.3)	6.6	11.0	(1.2)	(0.1)	16.0	—	16.0
EBITDA^(*)	420.0	290.4	(200.8)	(0.6)	237.6	746.6	—	746.6
Post retirement benefits.....	31.2	0.1	0.1	—	—	31.4	—	31.4
Depreciation and amortisation.....	327.9	122.8	128.9	(0.6)	(1.5)	577.6	—	577.6
Work force reduction program costs.....	(21.9)	—	0.3	—	—	(21.6)	—	(21.6)
Losses/(gains) on sales disposals of fixed assets, net.....	(23.5)	(3.5)	(0.2)	—	26.2	(1.1)	—	(1.1)
Other costs (gains), net.....	14.1	0.0	68.5	—	—	82.7	(68.7)	14.0
Income before financials and income taxes	92.2	171.0	(398.5)	(0.0)	212.9	77.6	68.7	146.3
Interests, net.....	273.9	5.5	154.5	—	(209.8)	224.1	—	224.1
Net foreign currency exchange losses/(gains).....	(1.3)	(0.0)	(0.6)	—	—	(2.0)	—	(2.0)
Losses/(Gains) on financial assets.....	(0.5)	—	—	—	0.5	(0.0)	—	(0.0)
Equity in earnings of associated companies.....	1,021.3	1,034.7	1,005.9	921.3	(2,977.6)	1,005.6	(1,008.0)	(2.3)
Net other financial expenses/(income).....	8.0	0.6	11.6	—	(0.5)	19.7	—	19.7
Income before income taxes	(1,209.3)	(869.7)	(1,569.8)	(921.3)	3,400.3	(1,169.9)	1,076.7	(93.2)
Provision for income taxes.....	47.2	51.6	(107.0)	—	—	(8.2)	—	(8.2)
Net income	(1,256.5)	(921.3)	(1,462.9)	(921.3)	3,400.3	(1,161.7)	1,076.7	(85.0)

(*) Defined as income before financials and income taxes plus post retirement costs, depreciation and amortization expenses, work force reduction program costs, net losses/(gains) on sales disposals of fixed assets and not other costs (gains).

Combined Income Statement for the nine months ended September 30, 2013 (Euro million)	Eliminations and adjustments		Contribution from other entities	Between PTC and MEO	Between PTC/MEO and other entities	Combined pre carve-out/in adjustments	Carve-out/in adjustments	COMBINED after carve-out/in adjustments
	PTC Standalone	MEO Standalone						
Operating Revenues	1,323.1	805.2	51.8	(207.1)	(9.7)	1,963.2	—	1,963.2
Services rendered.....	1,265.7	727.0	41.5	(188.1)	(4.5)	1,841.6	—	1,841.6
Sales.....	13.3	71.8	8.8	(5.7)	(0.3)	87.8	—	87.8
Other operating revenues.....	44.1	6.3	1.5	(13.3)	(4.8)	33.8	—	33.8
Costs from recurring operations	870.9	498.1	258.7	(206.4)	(233.7)	1,187.5	—	1,187.5
Wages and salaries.....	144.1	32.1	96.2	—	(0.3)	272.1	—	272.1
Direct costs.....	368.1	152.1	0.4	(181.1)	(10.8)	328.7	—	328.7
Commercial costs:								
Costs of products sold.....	8.4	79.0	3.8	(5.2)	(0.0)	86.0	—	86.0
Commissions.....	44.5	51.7	34.5	(0.7)	(36.1)	94.0	—	94.0
Marketing and publicity.....	18.9	13.6	11.2	(0.2)	(0.1)	43.4	—	43.4
Support Services.....	127.1	70.1	64.4	(3.3)	(163.4)	95.0	—	95.0
Maintenance and repairs.....	53.8	21.4	18.5	(1.1)	(8.8)	83.7	—	83.7
Supplies and external services.....	88.7	54.4	29.0	(13.4)	(13.9)	144.8	—	144.8
Provisions and adjustments.....	7.7	7.6	(0.2)	—	—	15.2	—	15.2
Taxes.....	11.5	12.0	0.5	—	—	24.0	—	24.0
Other operating costs.....	(2.1)	4.2	0.5	(1.5)	(0.3)	0.8	—	0.8
EBITDA^(*)	452.2	307.1	(206.9)	(0.7)	224.0	775.7	—	775.7
Post retirement benefits.....	31.7	0.0	0.1	—	—	31.8	—	31.8
Depreciation and amortisation.....	357.6	125.2	114.1	(0.7)	(1.5)	594.7	—	594.7
Work force reduction program costs.....	102.3	3.7	13.8	—	—	119.8	—	119.8
Losses/(gains) on sales disposals of fixed assets, net.....	(2.9)	(0.1)	(0.1)	—	—	(3.1)	—	(3.1)
Other costs (gains), net.....	(1.3)	13.1	4.9	—	—	16.7	—	16.7
Income before financials and income taxes	(35.2)	165.1	(339.7)	0.0	225.5	15.8	—	15.8
Interests, net.....	263.2	12.2	57.4	—	(138.0)	194.8	—	194.8
Net foreign currency exchange losses/(gains).....	1.3	0.0	1.8	—	—	3.0	—	3.0
Losses/(Gains) on financial assets.....	0.6	—	—	—	0.5	1.1	—	1.1

Equity in earnings of associated companies.....	(161.3)	(123.1)	(110.6)	(229.0)	513.4	(110.7)	107.4	(3.2)
Net other financial expenses/(income).....	5.3	0.8	1.2	—	(0.5)	6.9	—	6.9
Income before income taxes	(144.3)	275.2	(289.4)	229.0	(149.9)	(79.4)	(107.4)	(186.8)
Provision for income taxes.....	(5.2)	46.1	(6.9)	—	—	34.1	—	34.1
Net income	(139.1)	229.0	(282.5)	229.0	(149.9)	(113.4)	(107.4)	(220.9)

(*) Defined as income before financials and income taxes plus post retirement costs, depreciation and amortization expenses, work force reduction costs, net loss/(gains) on sales disposals of fixed assets and not other cost (gains).

Combined Income Statement for the year ended December 31, 2013 (Euro million)	Eliminations and adjustments							
	PTC Standalone	MEO Standalone	Contribution from other entities	Between PTC and MEO	Between PTC/MEO and other entities	Combined pre carve-out/in adjustments	Carve-out/in adjustments	COMBINED after carve-out/in adjustments
Operating Revenues	1,765.8	1,064.3	79.6	(269.3)	(13.0)	2,627.4	—	2,627.4
Services rendered.....	1,686.6	953.5	65.3	(242.0)	(6.1)	2,457.2	—	2,457.2
Sales.....	22.0	102.5	11.7	(9.5)	(0.4)	126.3	—	126.3
Other operating revenues.....	57.3	8.2	2.6	(17.8)	(6.4)	43.8	—	43.8
Costs from recurring operations	1,210.8	655.8	345.4	(268.4)	(342.7)	1,601.0	—	1,601.0
Wages and salaries.....	190.3	42.3	129.8	—	(0.6)	361.8	—	361.8
Direct costs.....	492.2	198.6	0.4	(232.7)	(14.8)	443.7	—	443.7
Commercial costs:								
Costs of products sold.....	16.2	111.8	5.1	(8.8)	(0.0)	124.2	—	124.2
Commissions.....	61.4	70.8	47.5	(0.9)	(49.6)	129.1	—	129.1
Marketing and publicity.....	26.2	18.8	14.9	(0.3)	(0.2)	59.5	—	59.5
Support Services.....	173.5	92.0	84.7	(4.4)	(219.1)	126.7	—	126.7
Maintenance and repairs.....	74.4	29.4	23.5	(1.8)	(11.4)	114.1	—	114.1
Supplies and external services.....	121.9	74.2	39.7	(17.6)	(18.5)	199.6	—	199.6
Provisions and adjustments.....	14.0	8.5	(0.2)	—	—	22.3	—	22.3
Taxes.....	14.2	14.6	0.5	—	0.0	29.3	—	29.3
Other operating costs.....	26.6	(5.1)	(0.5)	(2.0)	(28.5)	(9.4)	—	(9.4)
EBITDA ^(*)	555.1	408.5	(265.8)	(1.0)	329.7	1,026.4	—	1,026.4
Post retirement benefits.....	40.3	0.0	0.2	—	—	40.5	—	40.5
Depreciation and amortisation.....	477.7	168.2	153.7	(1.0)	(2.0)	796.7	—	796.7
Work force reduction program costs.....	112.8	4.1	1.4	—	—	118.3	—	118.3
Losses/(gains) on sales disposals of fixed assets, net.....	(3.4)	(0.1)	(0.1)	—	—	(3.6)	—	(3.6)
Other costs (gains, net).....	1.4	17.7	6.0	—	—	25.1	—	25.1
Income before financials and income taxes	(73.7)	218.5	(427.0)	0.0	331.7	49.5	—	49.5
Interests, net.....	353.3	15.9	85.0	—	(185.2)	269.0	—	269.0
Net foreign currency exchange losses/(gains).....	2.4	0.0	2.6	—	—	4.9	—	4.9
Losses/(Gains) on financial assets.....	0.5	—	—	—	0.6	1.1	—	1.1
Equity in earnings of associated companies.....	(234.4)	(194.7)	(179.3)	(336.1)	765.2	(179.3)	174.8	(4.5)
Net other financial expenses/(income).....	9.0	1.1	2.0	—	(0.6)	11.4	—	11.4
Income before income taxes	(204.5)	396.3	(337.2)	336.1	(248.3)	(57.6)	(174.8)	(232.4)
Provision for income taxes.....	5.8	60.1	8.8	—	—	74.7	—	74.7
Net income	(210.2)	336.1	(346.0)	336.1	(248.3)	(132.3)	(174.8)	(307.1)

(*) Defined as income before financials and income taxes plus post retirement costs, depreciation and amortization expenses, work force reduction program costs, net losses/(gains) on sales disposals of fixed assets and net other costs (gains).

Combined Income Statement Information for the year ended December 31, 2012 (Euro million)	Eliminations and adjustments							
	PTC Standalone	MEO Standalone	Contribution from other entities	Between PTC and MEO	Between PTC/MEO and other entities	Combined pre carve-out/in adjustments	Carve-out/in adjustments	COMBINED after carve-out/in adjustments
Operating Revenues	1,827.3	1,163.3	81.1	(285.1)	(17.2)	2,769.4	—	2,769.4
Services rendered.....	1,749.2	1,064.6	53.2	(263.0)	(10.1)	2,594.0	—	2,594.0
Sales.....	25.5	88.7	25.7	(5.0)	(0.3)	134.5	—	134.5
Other operating revenues.....	52.7	9.9	2.2	(17.1)	(6.8)	41.0	—	41.0
Costs from recurring operations	1,210.3	682.5	358.6	(280.2)	(329.4)	1,641.8	—	1,641.8
Wages and salaries.....	201.1	40.9	132.7	—	(0.5)	374.2	—	374.2
Direct costs.....	484.0	225.3	0.5	(247.7)	(22.4)	439.7	—	439.7
Commercial costs:								
Costs of products sold.....	24.6	100.9	6.1	(4.6)	(0.0)	127.0	—	127.0
Commissions.....	66.0	64.3	43.7	(1.3)	(46.6)	126.1	—	126.1
Marketing and publicity.....	20.7	23.6	18.8	(1.0)	(0.2)	61.8	—	61.8
Support Services.....	179.0	84.1	99.8	(4.6)	(219.4)	139.0	—	139.0
Maintenance and repairs.....	74.8	30.8	20.0	(2.6)	(21.8)	101.2	—	101.2
Supplies and external services.....	125.6	82.7	43.3	(16.4)	(17.8)	217.5	—	217.5
Provisions and adjustments.....	18.2	4.7	(0.2)	—	—	22.7	—	22.7
Taxes.....	15.4	15.8	0.7	—	—	31.8	—	31.8
Other operating costs.....	0.8	9.4	(6.8)	(1.9)	(0.7)	0.8	—	0.8
EBITDA ^(*)	617.0	480.8	(277.5)	(4.9)	312.2	1,127.6	—	1,127.6

Combined Income Statement Information for the year ended December 31, 2011 (Euro million)	Eliminations and adjustments							
	PTC	MEO	Contribution from other entities	Between PTC and MEO	Between PTC/MEO and other entities	Combined pre carve-out/in adjustments	Carve-out/in adjustments	COMBINED after carve-out/in adjustments
	Standalone	Standalone						
Operating Revenues	1,858.2	1,255.4	76.8	(193.4)	(41.6)	2,955.3	—	2,955.3
Services rendered	1,765.1	1,151.1	68.2	(171.0)	(11.3)	2,802.1		2,802.1
Sales	31.8	92.9	5.7	(8.3)	(0.4)	121.7		121.7
Other operating revenues.....	61.3	11.4	2.9	(14.1)	(29.9)	31.5		31.5
Costs from recurring operations	1,200.1	714.4	323.1	(188.0)	(361.9)	1,687.6	—	1,687.6
Wages and salaries	208.2	45.1	121.9	—	(1.3)	374.0		374.0
Direct costs	413.4	226.3	0.6	(155.2)	(12.3)	472.8		472.8
Commercial costs:								
Costs of products sold.....	27.5	105.0	3.8	(7.6)	(0.2)	128.6		128.6
Commissions	64.0	75.8	39.3	(1.4)	(45.7)	132.1		132.1
Marketing and publicity.....	26.2	29.6	18.3	(0.8)	(0.2)	73.1		73.1
Support Services	217.8	85.3	104.2	(5.1)	(263.3)	138.9		138.9
Maintenance and repairs.....	96.1	31.6	24.7	(1.1)	(22.3)	128.9		128.9
Supplies and external services.....	118.9	86.9	29.5	(14.7)	(16.8)	203.7		203.7
Provisions and adjustments	15.2	2.6	(0.2)	—	—	17.6		17.6
Taxes.....	13.8	15.4	0.3	(0.2)	0.2	29.5		29.5
Other operating costs.....	(1.0)	10.8	(19.3)	(2.0)	(0.0)	(11.5)		(11.5)
EBITDA (*)	658.1	541.0	(246.3)	(5.4)	320.4	1,267.7	—	1,267.7

(*) Defined as income before financials and income taxes plus post retirement costs, depreciation and amortization expenses, work force reduction program costs, net losses/(gains) on sales disposals of fixed assets and net other costs (gains).

Combined Cash Flow Statement for the Nine Months Ended September 30, 2014 (Euro million)	Eliminations and adjustments					
	PTC Standalone	MEO Standalone	Contribution from other entities	Between PTC and MEO	Between PTC/MEO and other entities	COMBINED
OPERATING ACTIVITIES						
Collections from clients.....	1,628.9	757.1	67.3	(266.7)	(19.3)	2,167.3
Payments to suppliers	(837.5)	(464.0)	(231.3)	261.1	318.6	(953.1)
Payments to employees.....	(142.7)	(34.7)	(106.8)	—	—	(284.1)
Payments relating to income taxes	(3.6)	9.2	(61.4)	—	0.0	(55.8)
Payments relating to post retirement benefits, net	(134.4)	(0.7)	(0.2)	—	(2.0)	(137.3)
Payments relating to indirect taxes and other	(26.6)	(77.7)	(31.5)	2.7	(18.7)	(151.7)
Cash flows from operating activities (1)	484.2	189.2	(363.9)	(2.8)	278.6	585.2
INVESTING ACTIVITIES						
Cash receipts resulting from:						
Short-term financial applications.....	—	—	55.9	—	—	55.9
Financial investments	5.9	0.0	6,445.4	—	(0.0)	6,451.2
Tangible and intangible assets	49.6	7.6	0.7	—	(52.3)	5.6
Interest and related income.....	2.1	1.3	39.7	—	—	43.0
Dividends	0.2	194.0	2.1	—	(194.0)	2.4
Other investing activities.....	—	—	11.3	—	—	11.3
	57.7	202.9	6,555.1	—	(246.3)	6,569.5
Payments resulting from:						
Short-term financial applications.....	—	—	(11.4)	—	—	(11.4)
Financial investments	(13.4)	—	(6,549.8)	—	—	(6,563.2)
Tangible assets	(258.2)	(54.8)	(14.8)	2.8	34.0	(291.0)
Intangible assets	(4.7)	(16.4)	(4.4)	—	0.0	(25.4)
Other investing activities.....	—	—	(200.0) ⁽¹⁾	—	—	(200.0) ⁽¹⁾
	(276.3)	(71.2)	(6,780.3)	2.8	34.0	(7,091.0)
Cash flows from investing activities (2)	(218.6)	131.7	(225.1)	2.8	(212.3)	(521.5)
FINANCING ACTIVITIES						
Cash receipts resulting from:						
Loans obtained	2,558.4	8.4	9,224.4	—	(2,558.4)	9,232.8
Increases in share capital and paid-in surplus	—	—	1,250.0	—	—	1,250.0
Subsidies	0.3	0.0	1.6	—	(0.0)	1.9
Other financing activities	—	—	0.0	—	—	0.0
	2,558.7	8.4	10,476.0	—	(2,558.4)	10,484.8
Payments resulting from:						
Loans repaid.....	(2,476.3)	(252.3)	(4,373.7)	—	0.9	(7,101.3)
Amortization of leasing contracts	(12.4)	(1.1)	(2.2)	—	—	(15.8)
Reductions in share capital and paid-in surplus.....	—	—	(2,967.7)	—	—	(2,967.7)
Interest and related expenses	(303.1)	(7.5)	(263.0)	—	216.7	(356.9)
Dividends	—	—	(0.9)	—	—	(0.9)
	(2,791.8)	(260.9)	(7,607.5)	—	217.7	(10,442.6)
Cash flows from financing activities (3)	(233.2)	(252.5)	2,868.6	—	(2,340.7)	42.2

Cash and cash equivalents at the beginning of the period.....	21.7	10.3	128.2
Change in cash and cash equivalents (4)=(1)+(2)+(3)...	32.4	68.3	105.9
Effect of exchange differences....	0.7	—	3.4
Changes in the consolidation perimeter.....	—	—	—
Cash and cash equivalents at the end of the period.....	54.9	78.6	237.6

(*) The payment related to other investment activities of €200 million for the nine months ended September 30, 2014 relates to the subscription of commercial paper of Rio Forte Investments, S.A. (“Rio Forte”) on April 15, 2014 and matured on July 15, 2014, which was not repaid by Rio Forte on the respective maturity date. This investment is carved-out from the unaudited balance sheet as of September 30, 2014 presented in the section “PT Portugal Unaudited Combined Adjusted Financial Information”, as it is out of the scope of the transaction perimeter.

Combined Cash Flow Statement for the Nine Months Ended September 30, 2013 (Euro million)	Eliminations and adjustments						COMBINED
	PTC Standalone	MEO Standalone	Contribution from other entities	Between PTC and MEO	Between PTC/MEO and other entities		
OPERATING ACTIVITIES							
Collections from clients.....	1,683.1	918.6	64.6	(319.2)	(23.9)		2,323.2
Payments to suppliers.....	(937.7)	(571.7)	(190.1)	309.4	329.9		(1,060.2)
Payments to employees.....	(139.1)	(33.9)	(120.3)	—	0.0		(293.3)
Payments relating to income taxes...	(2.0)	(46.3)	(37.0)	—	(0.0)		(85.3)
Payments relating to post retirement benefits, net.....	(134.2)	(1.0)	(0.1)	—	(1.0)		(136.3)
Payments relating to indirect taxes and other.....	(73.5)	(71.7)	(92.4)	8.1	1.1		(228.3)
Cash flows from operating activities (1).....	396.6	194.0	(375.3)	(1.7)	306.1		519.8
INVESTING ACTIVITIES							
Cash receipts resulting from:							
Short-term financial applications	—	—	38.3	—	—		38.3
Financial investments.....	376.0	—	2,270.9	(340.0)	—		2,306.9
Tangible and intangible assets....	5.2	0.8	0.5	—	—		6.4
Interest and related income.....	1.7	1.5	98.7	—	0.0		101.9
Dividends.....	2.7	67.9	3.2	—	(67.9)		5.9
Other investing activities.....	—	—	0.1	—	—		0.1
	385.5	70.2	2,411.5	(340.0)	(67.9)		2,459.4
Payments resulting from:							
Short-term financial applications	—	—	(40.7)	—	—		(40.7)
Financial investments.....	(8.4)	—	(2,450.8)	—	—		(2,459.2)
Tangible assets.....	(307.4)	(90.0)	(51.0)	1.7	41.9		(404.8)
Intangible assets.....	(7.5)	(15.1)	(0.8)	—	—		(23.3)
Other investing activities.....	—	—	(0.6)	—	—		(0.6)
	(323.3)	(105.1)	(2,543.7)	1.7	41.9		(2,928.5)
Cash flows from investing activities (2).....	62.2	(34.9)	(132.2)	(338.3)	(26.0)		(469.2)
FINANCING ACTIVITIES							
Cash receipts resulting from:							
Loans obtained.....	365.3	260.0	1,075.8	—	(252.0)		1,449.1
Increases in share capital and paid-in surplus.....	—	—	34.2	—	—		34.2
Subsidies.....	0.4	0.0	1.0	—	—		1.3
Other financing activities.....	—	—	—	—	—		—
	365.7	260.0	1,110.9	—	(252.0)		1,484.6
Payments resulting from:							
Loans repaid.....	(592.0)	(376.1)	(750.8)	340.0	—		(1,378.9)
Amortization of leasing contracts	(11.7)	(1.6)	(2.7)	—	0.0		(16.0)
Reductions in share capital and paid-in surplus.....	—	—	(35.5)	—	—		(35.5)
Interest and related expenses.....	(191.5)	(9.6)	(90.7)	—	65.5		(226.2)
Dividends.....	—	—	(0.9)	—	—		(0.9)
	(795.2)	(387.3)	(880.6)	340.0	65.5		(1,657.5)
Cash flows from financing activities (3).....	(429.5)	(127.3)	230.3	340.0	(186.5)		(172.9)
Cash and cash equivalents at the beginning of the period.....	21.2	7.8					286.5
Change in cash and cash equivalents (4)=(1)+(2)+(3).....	29.3	31.9					(122.3)
Effect of exchange differences.....	(1.0)	—					(7.7)
Changes in the consolidation perimeter.....	—	—					—
Cash and cash equivalents at the end of the period.....	49.5	39.6					156.4

Combined Cash Flow Statement for the Year Ended December 31, 2013 (Euro million)	Eliminations and adjustments					
	PTC Standalone	MEO Standalone	Contribution from other entities	Between PTC and MEO	Between PTC/MEO and other entities	COMBINED
OPERATING ACTIVITIES						
Collections from clients	2,234.2	1,224.6	81.0	(459.5)	(30.4)	3,049.9
Payments to suppliers	(1,265.7)	(747.0)	(323.8)	446.2	436.3	(1,453.9)
Payments to employees	(193.1)	(46.3)	(161.3)	—	(0.0)	(400.7)
Payments relating to income taxes ...	(6.3)	(69.9)	(41.5)	—	—	(117.7)
Payments relating to post retirement benefits, net	(178.9)	(1.3)	(0.2)	—	1.7	(178.7)
Payments relating to indirect taxes and other	(101.4)	(100.3)	(37.8)	11.1	(1.5)	(230.0)
Cash flows from operating activities (1)	488.8	259.8	(483.6)	(2.1)	406.0	668.9
INVESTING ACTIVITIES						
Cash receipts resulting from:						
Short-term financial applications	—	—	38.5	—	—	38.5
Financial investments	376.5	—	2,270.9	(340.0)	—	2,307.3
Tangible and intangible assets	6.1	1.1	0.6	—	(0.0)	7.7
Interest and related income	33.3	2.2	114.1	(30.1)	(0.0)	119.4
Dividends	2.7	67.9	3.1	—	(67.9)	5.8
Other investing activities	—	—	0.2	—	—	0.2
	418.5	71.1	2,427.3	(370.1)	(67.9)	2,478.9
Payments resulting from:						
Short-term financial applications	—	—	(40.8)	—	—	(40.8)
Financial investments	(44.0)	—	(2,464.8)	—	0.0	(2,508.9)
Tangible assets	(399.1)	(126.4)	(58.3)	2.1	54.9	(526.7)
Intangible assets	(8.8)	(22.8)	(1.7)	—	(0.0)	(33.3)
Other investing activities	—	—	(0.6)	—	—	(0.6)
	(451.9)	(149.2)	(2,566.2)	2.1	54.9	(3,110.3)
Cash flows from investing activities (2)	(33.4)	(78.1)	(138.9)	(368.0)	(13.0)	(631.4)
FINANCING ACTIVITIES						
Cash receipts resulting from:						
Loans obtained	476.4	252.0	1,060.0	—	(252.0)	1,536.3
Increases in share capital and paid-in surplus	—	—	2,134.2	—	—	2,134.2
Subsidies	0.3	0.0	1.3	—	—	1.7
Other financing activities	—	—	—	—	—	—
	476.7	252.0	3,195.4	—	(252.0)	3,672.1
Payments resulting from:						
Loans repaid	(592.0)	(386.2)	(754.6)	340.0	—	(1,392.8)
Amortization of leasing contracts	(16.6)	(2.1)	(3.5)	—	—	(22.2)
Reductions in share capital and paid-in surplus	—	—	(2,135.5)	—	—	(2,135.5)
Interest and related expenses	(321.0)	(42.9)	(131.2)	30.1	160.4	(304.5)
Dividends	—	—	(0.9)	—	—	(0.9)
	(929.7)	(431.2)	(3,025.6)	370.1	160.4	(3,856.0)
Cash flows from financing activities (3)	(453.0)	(179.2)	169.8	370.1	(91.6)	(183.9)
Cash and cash equivalents at the beginning of the period	21.2	7.8	—	—	—	286.5
Change in cash and cash equivalents (4)=(1)+(2)+(3)	2.4	2.5	—	—	—	(146.4)
Effect of exchange differences	(1.9)	—	—	—	—	(11.4)
Changes in the consolidation perimeter	—	—	—	—	—	—
Cash and cash equivalents at the end of the period	21.7	10.3	—	—	—	128.7

Combined Cash Flow Statement Information for the Year Ended December 31, 2012 (Euro million)	Eliminations and adjustments					
	PTC Standalone	MEO Standalone	Contribution from other entities	Between PTC and MEO	Between PTC/MEO and other entities	COMBINED
OPERATING ACTIVITIES						
Collections from clients	2,404.8	1,424.9	73.0	(419.6)	(15.0)	3,468.0
Payments to suppliers	(1,409.9)	(765.6)	(360.2)	393.4	444.5	(1,697.7)
Payments to employees	(206.4)	(48.7)	(144.8)	—	—	(400.0)
Payments relating to income taxes	35.9	(92.1)	(15.2)	—	—	(71.4)
Payments relating to post retirement benefits, net ...	(186.4)	(0.2)	(0.1)	—	4.9	(181.8)
Payments relating to indirect taxes and other	(94.3)	(85.6)	(38.1)	8.8	(19.4)	(228.5)
Cash flows from operating activities	543.8	432.6	(485.4)	(17.3)	415.0	888.6

**INVESTING
ACTIVITIES**

Cash receipts resulting from:						
Short-term financial applications.....						
	—	—	285.5	—	—	285.5
Financial investments						
	—	—	116.5	—	—	116.5
Tangible and intangible assets.....						
	3.7	2.7	0.2	—	—	6.5
Interest and related income						
	2.9	3.4	94.4	—	—	100.7
Dividends						
	238.3	5.0	3.8	(235.5)	(5.1)	6.6
Other investing activities						
	—	—	1.9	—	—	1.9
	244.8	11.1	502.2	(235.5)	(5.1)	517.6
Payments resulting from:						
Short-term financial applications.....						
	—	—	—	—	—	—
Financial investments						
	(2.8)	—	(2,270.0)	—	1.2	(2,271.6)
Tangible assets						
	(531.2)	(163.2)	(18.9)	17.3	70.5	(625.5)
Intangible assets						
	(7.8)	(129.4)	(1.0)	—	—	(138.1)
Other investing activities						
	—	—	(0.6)	—	(1.1)	(1.6)
	(541.8)	(292.6)	(2,290.4)	17.3	70.6	(3,036.9)
Cash flows from investing activities						
	(296.9)	(281.5)	(1,788.2)	(218.2)	65.5	2,519.3

Eliminations and adjustments

**Combined Cash Flow
Statement Information for the
Year Ended December 31,
2011
(Euro million)**

	PTC Standalone	MEO Standalone	Contribution from other entities	Between PTC and MEO	Between PTC/MEO and other entities	COMBINED
OPERATING ACTIVITIES						
Collections from clients	2,402.7	1,457.5	100.4	(286.8)	(26.4)	3,647.4
Payments to suppliers.....	(1,318.1)	(762.0)	(324.1)	277.9	445.0	(1,681.2)
Payments to employees	(211.8)	(48.9)	(150.2)	—	2.8	(408.1)
Payments relating to income taxes	(52.2)	(83.6)	(30.3)	—	—	(166.1)
Payments relating to post retirement benefits, net	(194.5)	(0.5)	(1.4)	—	(2.8)	(199.2)
Payments relating to indirect taxes and other	(47.5)	(86.5)	(52.9)	6.2	0.2	(180.4)
Cash flows from operating activities	578.7	476.0	(458.4)	(2.7)	418.8	1,012.3
INVESTING ACTIVITIES						
Cash receipts resulting from:						
Short-term financial applications.....						
	—	—	—	—	—	—
Financial investments.....						
	160.1	—	2,142.6	(160.0)	—	2,142.8
Tangible and intangible assets.....						
	3.2	6.9	0.3	—	—	10.3
Interest and related income ..						
	3.0	7.8	62.6	—	—	73.4
Dividends.....						
	2.4	—	0.4	—	(0.3)	2.6
Other investing activities						
	—	—	323.3	—	—	323.3
	168.7	14.7	2,529.2	(160.0)	(0.3)	2,552.3
Payments resulting from:						
Short-term financial applications.....						
	—	—	—	—	—	—
Financial investments.....						
	(2.3)	—	(3,902.8)	—	(85.4)	(3,990.4)
Tangible assets						
	(559.7)	(115.2)	(7.4)	2.7	74.4	(605.2)
Intangible assets						
	(10.3)	(52.5)	(2.1)	—	—	(64.9)
Other investing activities						
	—	—	(9.1)	—	(2.3)	(11.3)
	(572.3)	(167.7)	(3,921.3)	2.7	(13.3)	(4,671.8)
Cash flows from investing activities						
	(403.5)	(153.0)	(1,392.1)	(157.3)	(13.5)	(2,119.5)

Basis of Preparation

On December 9, 2014, Altice, S.A. entered into an agreement to acquire from Oi, S.A. 100% of the issued share capital of PT Portugal, SGPS, S.A. (the “Transaction”), and accordingly, the PT Portugal Group and its assets (“PT Portugal Group”). Prior to the consummation of the sale and as a condition precedent to its closing, certain corporate reorganizations (the “Carve Out Reorganization”) will be required to take place in order to delineate the operations to be transferred as well as to separate PT Portugal’s investments, in Africatel GmbH & Co. KG and Timor Telecom S.A. and the investments held by PT Portugal in Rio Forte Investments S.A., which will not be included in the Transaction, as well as all or part of PT Portugal’s indebtedness. The PT Portugal Group comprises the entities presented in the table below, each of which will be wholly owned subsidiaries of PT Portugal following the completion of the Carve Out Reorganization. The table below also includes the entities in which the PT Portugal Group will own an ownership interest of less than 50%.

ENTITIES WITHIN THE TRANSACTION PERIMETER AS OF SEPTEMBER 30, 2014			
CONSOLIDATED		ACCOUNTED FOR BY THE EQUITY METHOD OR AT COST	
Name	Interest	Name	Interest
PT Portugal, SGPS, S.A.		ADRAL—Agência de Desenvolvimento Regional do Alentejo, S.A.	1.00%
PT Comunicações, S.A.	100%	Apor—Agência para Modernização do Porto, S.A.	2.66%
MEO—Serviços de Comunicações e Multimédia, S.A.	100%	Auto Venda Já, S.A.	50.00%
Contact Cabo Verde—Telemarketing e Serviços de Informação, S.A.	100%	Caixanet—Telemática e Comunicações, S.A.	15.00%
Open Idea (Angola)	100%	Capital Criativo, SCR, S.A.	10.00%
Openidea—Tecnologias de Telecomunicações e Sistemas de Informação, S.A.	100%	Coimbravita—Agência de Desenvolvimento Regional, S.A.	4.48%
Open Idea (Morocco)	100%	Ericsson Inovação, S.A.	49.00%
Postal Network—Prestação de Serviços de Gestão de Infra-estrutura de comunicações, A.C.E.	51.00%	Fibroglobal—Comunicações Electrónicas, S.A.	5.00%
Previsão—Sociedade Gestora de Fundos de Pensões, S.A.	82.05%	Hungaro DigiTel Kft.	44.62%
PT Blueclip—Serviços de Gestão, S.A.	100%	INESC—Instituto de Engenharia de Sistemas e Computadores, S.A.	41.38%
Portugal Telecom Brasil, S.A.	100%	Itexample, A.C.E.	5.17%
Portugal Telecom Data Center, S.A.	100%	Janela Digital—Informativo e Telecomunicações, Lda	50.00%
Portugal Telecom Inovação Brasil S.A.	100%	Multicert—Serviços de Certificação Electrónica, S.A.	20.00%
PT Centro Corporativo, S.A.	100%	NP—Notícias de Portugal, CRL	6.66%
PT Cloud e Data Centers, S.A.	100%	Open Labs Pesquisa e Desenvolvimento Ltda.	99.80%
PT Contact—Telemarketing e Serviços de Informação, S.A.	100%	Parkubis—Parque de Ciência e Tecnologia da Covilhã S.A.	2.00%
PT Imobiliária, S.A.	100%	PCI—Parque Ciência Tecnologia, S.A.	5.00%
PT Inovação e Sistemas, S.A.	100%	PT P&F, A.C.E.	49.00%
PT Móveis—Serviços de Telecomunicações, SGPS, S.A.	100%	SIRESP—Gestão de Redes Digitais de Segurança e Emergência, S.A.	30.55%
PT Pay, S.A.	100%	Sportinveste Multimédia, SGPS, S.A.	50.00%
PT Prestações—Mandatária de Aquisições e Gestão de Bens, S.A.	100%	Startec Global Communication	0.70%
PT PRO—Serviços Administrativos e de Gestão Partilhados, S.A.	100%	Taguspark—Sociedade de Promoção e Desenvolvimento do Parque de Ciência e Tecnologia da Área de Lisboa, S.A.	9.43%
PT Sales—Serviços de Telecomunicações e Sistemas de Informação, S.A.	100%	Vortal, SGPS, S.A.	8.54%
PT Multimédia.com Brasil, Lda.	100%	Yunit Serviços, S.A.	33.33%

This unaudited combined adjusted financial information has been prepared to present the financial information of the target perimeter companies for the applicable periods.

The combined financial information presented above represents an aggregation of the historical financial information extracted from the accounting records of the PT Portugal Group, basically adjusted for (1) consolidation adjustments and (2) adjustments to remove from the balance sheet and income statements the effects related to the companies and other assets that will not be part of the transaction described above.

In the following paragraphs we will describe in more detail the basis of presentation of each piece of the unaudited combined adjusted financial information presented above.

The unaudited combined balance sheet as of September 30, 2014 reflects the aggregation of the following:

1. *PTC Standalone and MEO Standalone*: Unaudited condensed balance sheets of PTC and Meo, S.A. prepared in accordance with Portuguese GAAP (“PGAAP”), which for purposes of this combined financial information were presented under the same format as that used for financial information published by Portugal Telecom SGPS, S.A. (the “international format” or “PT format”), reflecting certain reclassifications as compared to the balance sheet format presented for PGAAP purposes. Under the PT format, EBITDA is defined as income before financials and income taxes plus post retirement benefits costs, depreciation and amortization expenses, work force reduction program costs, net losses/(gains) on sales disposals of fixed assets and net other costs (gains).
2. *Contribution from other entities*: Unaudited financial information (assets and liabilities) of the other companies that will be included in the target perimeter. These other companies financial information include the investments of PT Portugal and its subsidiaries in the net assets of PT Finance, PT Investimentos, PT Participações (companies that are excluded from the target perimeter) and in Rio Forte Investments, S.A., which are eliminated in the column “Assets carve-out/in to adjust the perimeter”—see point 5 below. This financial information has been extracted from the accounting records of each company included in the transaction perimeter, adjusted for intercompany eliminations;
3. *Eliminations and adjustments between PTC and MEO*: Eliminations of the intercompany balances between PTC and MEO and the financial investment recorded by PTC relating to MEO, a wholly owned subsidiary of PTC, since under PGAAP PTC accounts for the investment in MEO by the equity method;
4. *Eliminations and adjustments between PTC/MEO and other PT Target Businesses* include:
 - (a) the elimination of intercompany balances between both PTC and MEO and the other subsidiaries of the PT Portugal Group, which relate mainly to trade payables due by PTC and MEO to other companies, intercompany debt and related accrued interest due by PTC to PT Portugal, and income tax liabilities due by PTC and MEO to PT Portugal in connection with the tax consolidation regime adopted by PT Portugal. Income tax receivables from or payables to the Portuguese State in relation to the tax consolidation regime are recorded in the standalone financial statements of PT Portugal, currently the parent company of the tax consolidation group, while its subsidiaries also included in this tax consolidation regime, including PTC and MEO, record its income tax receivables or payables as intercompany receivables from or payables to PT Portugal, which are therefore eliminated in the consolidation process and also in this combination process;
 - (b) the elimination of the financial investments held by PTC and Meo S.A. in the other subsidiaries of the target perimeter; and
 - (c) the elimination of goodwill generated following internal sale and purchase agreements settled between companies within the PT Portugal Group;
5. *Assets carve-out/in to adjust the perimeter*: The elimination and incorporation of certain assets in order to adjust the unaudited combined balance sheet to reflect only the assets and liabilities of the target companies; these adjustments reflect (i) the carve-out of the financial investments in PT Finance BV, S.A. (a finance vehicle) and PT Investimentos (holding company for foreign investments) in the amounts of €235.4 million and €6.9 million, respectively, which were recorded at PT Portugal standalone financial statements, (ii) the carve-out of the financial investment in PT Participações (holding company that holds the investments in Africa and Timor) in the amount of €1,533.8 million, which was recorded at PT Móveis, (iii) the elimination of the Rio Forte investment (commercial paper issued by Rio Forte) recorded at PT Portugal, amounting to €200.0 million, and (iv) the incorporation of the financial investments in Hungaro Digitel and Siresp, in the amounts of €2.5 million and €5.7 million, respectively, entities that are included in the target perimeter companies but the

investments of which were recorded at PT Participações, an entity outside the target perimeter companies.

The PT Portugal unaudited combined income and cash flow statements for the nine months ended September 30, 2014 and 2013 and the years ended December 31, 2013, 2012 and 2011 reflect the aggregation of the following:

1. *PTC Standalone and MEO Standalone*: Unaudited income and cash flow statements of PTC and Meo, S.A. for the nine months ended September 30, 2014 and 2013 and audited condensed income and cash flow statements of PTC and Meo, S.A. for the years ended December 31, 2013, 2012 and 2011. As already explained above in relation to the balance sheet, the income statements are also prepared in accordance with Portuguese GAAP but for purposes of this combined financial information of the PT Portugal Group were presented under the PT format, reflecting certain reclassifications as compared to the profit and loss format presented for PGAAP purposes. These reclassifications primarily reflect certain captions that under Portuguese GAAP are included as operating items while under the PT format are presented as an operating item but not included on the computation of EBITDA (as defined above), namely “Post retirement benefits”, “Work force reduction program costs”, “Losses/(gains) on sales disposals of fixed assets, net”, “Other costs (gains), net” and “Equity in earnings of associated companies”. It should also be mentioned that prior to 2014, the parent company of the tax consolidation regime was Portugal Telecom and whenever entities included in this tax consolidation group, such as PTC and MEO, presented tax losses, the related income tax gain was not recorded in that entity but in the parent company of the tax consolidation group, which prior to 2014 was Portugal Telecom, an entity not included in the transaction perimeter. For the years ended December 31, 2013, 2012 and 2011, the income tax gain recorded by Portugal Telecom (and thus not included in this combined adjusted income statement) relating to PTC’s tax losses amounted to €90.8 million, €170.1 million and €217.0 million, respectively, since deferred tax assets on tax losses are recorded directly by the parent company of the tax consolidation group.
2. *Contribution from other entities*: Unaudited aggregation of financial information (revenues and costs) of the other subsidiaries included in the target perimeter, which was presented net of intercompany eliminations;
3. *Eliminations and adjustments between PTC and MEO*: eliminations of the intercompany revenues, costs, cash receipts and cash payments between PTC and Meo, S.A. and also PTC’s equity in earnings of MEO;
4. *Eliminations and adjustments between PTC/MEO and other PT Target Businesses* include:
 - (a) the elimination of intercompany revenues, costs, cash receipts and cash payments between PTC and/or MEO and the other entities within the target perimeter, which relate mainly to operating costs incurred by PTC and/or MEO with other companies and interest expenses in connection with intercompany debt due from PTC to PT Portugal;
 - (b) the elimination of PTC’s and MEO’s equity in earnings of the other subsidiaries of the PT Portugal Group; and
 - (c) IFRS adjustments related to the impact of the adoption of the revised version of IAS 19 in the combined adjusted income statement for the year ended December 31, 2011, because PTC’s unaudited standalone financial statements for that year did not yet reflect the adoption of this revised standard; these IFRS adjustments are included because as PT Portugal’s consolidated financial statements are prepared in accordance with IFRS, this unaudited combined financial information was also prepared in accordance with IFRS, despite PTC and MEO’s standalone financial statements being prepared under PGAAP;
5. *Carve-out/in adjustments*: The elimination and inclusion adjustments of the gains and costs incurred by the companies that have been excluded and included in the Transaction, reflecting the reversal of the gains and losses resulting from either the equity method of accounting in or the disposal of entities that are outside the target perimeter, and the inclusion of the gains and losses resulting from the equity method of accounting in entities included in the target perimeter. These adjustments primarily include (1) the equity in the earnings or losses of PT Finance and PT Investimentos, both of which recorded at PT Portugal, (2) the equity in the earnings or losses of Bratel BV (an entity that is not included in the transaction perimeter that held the investments in Oi and Contax) and PT Participações, both of which recorded at PT Móveis, and (3) the gains or losses on the disposal of the investments in CTM and UOL, which were recorded by PT Comunicações and PT Brasil in 2013 and 2011, respectively.

The table below presents a summary of the effects on the combined adjusted balance sheet as of September 30, 2014 resulting from the carve-out and carve-in adjustments:

Adjustments to the combined adjusted balance sheet as of September 30, 2014	Investments in associated companies	Other current assets	Total carve-out/in adjustments
Carve-out of PT Participações	(1,533.8)	—	(1,533.8)
Carve-out of PT Finance	(235.4)	—	(235.4)
Carve-out of PT Investimentos	(6.9)	—	(6.9)
Carve-out of Carrigans and CV TEL	(0.0)	—	(0.0)
Carve-out of Rio Forte	—	(200.0)	(200.0)
Acquisition of Hungaro Digital.....	2.5	—	2.5
Acquisition of Siresp	5.7	—	5.7
	(1,767.9)	(200.0)	(1,967.9)

The table below presents a summary of the effects on the combined adjusted income statements for the nine months ended September 30, 2014 and 2013 and the years ended December 31, 2013, 2012 and 2011 resulting from (i) the elimination of the gains and losses recorded by perimeter entities in connection with the equity method of accounting in or the disposal of entities that are outside the target perimeter and (2) the inclusion of gains and losses recorded by entities outside perimeter that relate to the equity method of accounting in entities included in the target perimeter:

Adjustments to the combined adjusted income statements	Years ended December 31,			Nine months ended September 30,	
	2011	2012	2013	2013	2014
Reversal of equity accounting over entites outside perimeter					
PT Participações ⁽ⁱ⁾	—	—	—	—	17.9
PT Finance ⁽ⁱ⁾	—	—	—	—	14.8
PT Investimentos ⁽ⁱ⁾	—	—	—	—	(2.2)
Carrigans and CV TEL	0.1	0.0	0.0	(0.0)	(0.0)
Bratel BV ⁽ⁱⁱ⁾	37.9	2.4	(141.2)	(76.0)	25.2
Contax ⁽ⁱⁱ⁾	0.4	(0.2)	(1.4)	(0.0)	1.1
CTX ⁽ⁱⁱ⁾	1.4	0.5	(0.9)	0.4	0.9
CTM ⁽ⁱⁱⁱ⁾	(2.5)	(2.8)	—	—	—
Mobitel ^(iv)	9.0	—	—	—	—
Reversal of gains and losses on the disposal of entities outside perimeter					
CTM ⁽ⁱⁱⁱ⁾	—	—	(33.5)	(33.5)	—
UOL ^(v)	(9.0)	—	—	—	—
Inclusion of equity accounting over entites inside perimeter					
Hungaro Digital ^(vi)	0.6	0.5	0.5	0.3	0.3
Siresp ^(vi)	1.2	1.4	1.8	1.4	0.1
Sportinveste ^(vii)	(0.1)	(2.3)	0.0	0.1	—
Yunit ^(vii)	0.0	(0.2)	(0.2)	(0.1)	—
Foreign currency losses recycled to net income by PT Móveis upon the disposal of Bratel BV ^(viii)	—	—	—	—	949.9
Loss recorded by PT Móveis relating to the investment in PT Participações ^(ix)	—	—	—	—	68.7
Total impact in net income	38.8	(0.6)	(174.8)	(107.4)	1,076.7

(i) Represents the equity accounting in losses (gains) of these entities recorded by PT Móveis (investment in PT Participações) and PT Portugal (PT Finance and PT Investimentos) as from May 2014, which were excluded from the combined income statement since these investments are outside the target perimeter. PT Móveis and PT Portugal acquired these investments in the beginning of May 2014.

(ii) Represents the equity accounting in losses (gains) of these entities recorded by PT Móveis (investment in Bratel BV, entity that held the investment in Oi) and PT Brasil (investments in Contax and CTX). The investments in Bratel BV, Contax and CTX were disposed to Portugal Telecom, SGPS, S.A. in the beginning of May 2014 and therefore, in relation to the nine months ended September 2014, these captions correspond only to the losses for the four months period ended April 30, 2014.

(iii) These captions correspond to gains recorded by PTC regarding its 3% interest in Companhia de Telecomunicações de Macao (“CTM”), including the gains through the equity accounting method until the end of 2012 and the capital gain recorded in 2013 upon the disposal of this investment.

(iv) This caption corresponds to the losses recorded by PT Brasil through the equity method of accounting over Mobitel, Portugal Telecom, SGPS, S.A. group’s call centre operation in Brasil prior to the disposal of Vivo. During the year 2011, PT Brasil subscribed a share capital increase in Contax (call centre business rendering services to Oi) through the contribution in kind of this investment.

(v) This caption corresponds to the capital gain recorded by PT Brasil in connection with the disposal of this investment in January 2011.

(vi) These captions correspond to the losses (gains) recorded by PT Participações (outside perimeter) over these entities through the equity method of accounting, since both Hungaro Digital and Siresp are included in the target perimeter. As mentioned above, these entities will be acquired by PT Móveis from PT Participações prior to the closing of the acquisition of PT Portugal by Altice.

- (vii) These captions correspond to the losses (gains) recorded by Portugal Telecom SGPS (outside perimeter) over these entities through the equity method of accounting, since both Sportinveste and Yunit are included in the target perimeter. These entities were disposed by Portugal Telecom SGPS to PTC in the end of 2013.
- (viii) This caption corresponds to the net loss recorded by PT Móveis in connection with the sale of Bratel BV to Portugal Telecom SGPS, including (1) a capital gain of €50.0 million corresponding to the difference between the sale price and the carrying value of the investment, and (2) foreign currency losses of €1,000.0 million relating to the depreciation of the Brazilian Real against the Euro since the acquisition of the investment in Oi in March 2011, which were recycled to net income upon the disposal of the investment. This net loss was excluded from the combined adjusted income statement as it relates to an entity outside the perimeter.
- (ix) This caption corresponds to a loss recorded by PT Móveis in connection with the acquisition of PT Participações in order to adjust the carrying value of its investments to the correspondent recoverable amounts. This loss was also excluded from the combined profit and loss statement as it relates to entities outside the perimeter.

Selected Notes to the Combined Adjusted Balance Sheet and Income Statements

The tables below present unaudited selected disclosures to the main captions of the combined adjusted balance sheet as of September 30, 2014 (amounts in Euro million):

Cash and equivalents	Sep 30, 2014
Cash, cash equivalents.....	237.6
Short-term investments	7.1
Total	244.7
Accounts receivable, net	Sep 30, 2014
Accounts receivable from customers	799.5
Unbilled revenues.....	113.7
Receivables from related parties	30.6
Advances to suppliers.....	9.7
Accrued interest income.....	1.6
Other	130.2
Sub-total	1,085.2
Adjustments for doubtful accounts receivable—trade	(200.5)
Adjustments for other current accounts receivable	(10.5)
Total	874.3
Tax receivable	Sep 30, 2014
Value Added Tax.....	19.6
Corporate Income Tax.....	62.5
Other Taxes.....	3.0
Total	85.1
Prepaid expenses and other current assets	Sep 30, 2014
Prepaid expenses—direct costs.....	11.5
Prepaid expenses—commissions and up-front fees	12.4
Prepaid expenses—other	23.3
Other current assets	1.1
Total	48.3
Fixed assets, net	Sep 30, 2014
Land	173.0
Buildings and other constructions.....	515.8
Basic equipment	2,117.9
Transportation equipment	19.3
Tools and dies.....	0.2
Administrative equipment	123.7
Other tangible assets.....	3.8
In-progress tangible assets	149.3
Advances to suppliers of tangible assets.....	0.6
Total	3,103.7
Deferred tax assets	Sep 30, 2014
Post-retirement benefits.....	289.4
Tax losses carryforward (iii)	35.4

Provisions and adjustments	56.8
Other	10.0
Total	391.5
Deferred tax liabilities	
	Sep 30, 2014
Revaluation of fixed assets	141.0
Other	0.5
Total	141.5
Debt	
	Sep 30, 2014
Short-term debt	
Bank loans (EIB)	61.1
External commercial paper	396.3
Intercompany loans (PT Finance and Oi)	1,340.2
Leasings	20.3
Total	1,817.8
Medium and long-term debt	
Retail Bond	—
Bank loans (EIB)	453.6
Intercompany loans (PT Finance)	6,859.6
Leasings	23.2
Total	7,336.4
Current accounts payable	
	Sep 30, 2014
Accounts payable-trade	385.5
Fixed asset suppliers	37.3
Licenses and concessions	6.0
Accounts payable to employees	1.5
Due to PT SGPS under consolidation tax regime	0.0
Due to PT Prestações under a transfer of customer receivables	45.0
Other	2.9
Total	478.2
Non-current accounts payable	
	Sep 30, 2014
Licenses and concessions	9.9
Other	9.1
Total	19.0
Accrued expenses	
	Sep 30, 2014
Supplies and external services	159
Vacation pay and bonuses	90.5
Interest and other financial expenses	37.6
Discounts to clients	26.0
Indirect taxes	11.2
Other	20.5
Total	345.1
Tax payable	
	Sep 30, 2014
Value Added Tax	50.1
Income taxes	21.0
Social Security Contributions	10.1
Other Taxes	9.7
Total	90.9

Current provisions and other liabilities	Sep 30, 2014
Provisions for taxes	30.1
Provisions for legal actions	17.4
Provisions for other risks and charges	2.4
Other current liabilities	0.4
Total	50.3

Non-current provisions and other liabilities	Sep 30, 2014
Assets retirement obligation	19.0
Other non-current liabilities	1.3
Total	20.3

The tables below present selected disclosures to the main captions of the combined adjusted income statements for the nine months ended September 30, 2014 and 2013 and the years ended December 31, 2013, 2012 and 2011 (amounts in Euro million):

CAPTION	FY11	FY12	FY13	9M13	9M14
Portugal telecommunications business	2,892.0	2,700.5	2,559.6	1,920.3	1,849.0
Consumer	1,450.7	1,399.8	1,371.0	1,024.1	997.6
Residential	682.3	711.7	708.8	531.5	528.8
Personal	768.4	688.1	662.3	492.6	468.8
Enterprise	1,008.6	896.0	796.1	598.0	563.0
Other and eliminations	432.7	404.7	392.5	298.1	288.3
Other entites in transaction perimeter	63.3	68.9	67.7	43.0	52.0
Operating revenues	2,955.3	2,769.4	2,627.4	1,963.2	1,900.9
Direct Costs	FY11	FY12	FY13	9M13	9M14
Traffic costs	231.2	211.7	210.0	154.7	168.3
Capacity costs	38.0	37.3	39.9	29.0	30.4
Programming costs	120.0	122.6	127.9	94.8	94.4
Directories	35.6	26.4	20.7	16.0	13.3
Other	48.0	41.7	45.2	34.2	35.1
Total	472.8	439.7	443.7	328.7	341.5
Supplies and External Services	FY11	FY12	FY13	9M13	9M14
Specialized work	68.9	67.8	56.7	41.8	69.9
Electricity	45.6	46.7	47.3	35.2	32.4
Operating leases	26.0	25.2	27.1	19.1	19.9
Communications	15.4	13.3	12.6	9.6	8.9
Other	47.8	64.5	55.9	39.2	39.7
Total	203.7	217.5	199.6	144.8	170.9
Provisions and Adjustments	FY11	FY12	FY13	9M13	9M14
Allowance for bad debt	20.0	22.8	22.9	15.6	14.2
Provisions for contingencies	(3.5)	(0.9)	(4.3)	(3.4)	(0.4)
Other	1.0	0.8	3.7	2.9	(5.3)
Total	17.6	22.7	22.3	15.2	8.6

PT PORTUGAL PRE-CLOSING UNAUDITED COMBINED PRO FORMA BALANCE SHEET

The Pre-closing Unaudited Combined Pro forma Balance Sheet presented below reflects the Unaudited Combined Adjusted Balance Sheet as of September 30, 2014 presented under the section “Unaudited Combined Adjusted Financial Information” adjusted additionally for the effects of certain transactions agreed between Oi and Altice to be completed prior to the completion of the business combination.

Pre-closing Unaudited Combined Proforma Balance Sheet as of September 30, 2014 (Euro million)	Combined after carve-out/in adjustments	Corporate transactions pre-closing	COMBINED PROFORMA
ASSETS			
Current Assets			
Cash, cash equivalents and short-term investments	244.7	(1.2)	243.5
Accounts receivable, net	874.3	—	874.3
Inventories, net	75.5	—	75.5
Tax receivable.....	85.1	—	85.1
Other current assets	48.3	—	48.3
Non current assets held for sale	(0.0)	—	(0.0)
Total Current Assets	1,327.9	(1.2)	1,326.7
Non-Current Assets			
Investments in group and associated companies	20.7	(0.0)	20.7
Investments in intercompany loans.....	3,406.0	(3,406.0)	(0.0)
Other investments.....	22.9	3.0	25.9
Goodwill	3,723.7	—	3,723.7
Intangible assets.....	574.5	—	574.5
Fixed assets, net.....	3,103.7	—	3,103.7
Post retirement benefits	1.9	—	1.9
Deferred taxes	391.5	—	391.5
Other non-current assets.....	1.8	—	1.8
Total Non-Current Assets	11,246.7	(3,403.0)	7,843.7
Total Assets	12,574.5	(3,404.2)	9,170.4
LIABILITIES			
Current Liabilities			
Short term debt	477.6	—	477.6
Short term intercompany debt.....	1,340.2	—	1,340.2
Accounts payable.....	478.2	—	478.2
Accrued expenses	345.1	—	345.1
Deferred income	159.0	—	159.0
Tax payable.....	90.9	—	90.9
Provisions	49.9	—	49.9
Other liabilities	0.4	—	0.4
Total Current Liabilities	2,941.3	—	2,941.3
Non-Current liabilities			
Medium and long-term debt.....	876.8	(400.0)	476.8
Medium and long-term Intercompany debt.....	6,859.6	(3,324.0)	3,535.6
Accounts payable.....	19.0	—	19.0
Deferred income	0.0	—	0.0
Provisions	1.3	—	1.3
Post retirement benefits.....	1,073.6	—	1,073.6
Deferred taxes	141.5	—	141.5
Other liabilities	19.0	—	19.0
Total Non-Current Liabilities	8,990.8	(3,724.0)	5,266.8
Total Liabilities	11,932.1	(3,724.0)	8,208.1
Net Assets	642.5	319.8	962.3

The transactions referred to above consisted basically of the following corporate transactions to be completed prior to the execution of the business combination:

- (a) repayment of debt due by CV TEL, B.V. (entity not included in the transaction perimeter) to PT Móveis amounting to €3,401.0 million, recorded in the balance sheet under the caption “*Investments in intercompany loans*”, through the reduction of a portion of the “*Medium and long-term intercompany*”

debt” due to Portugal Telecom International Finance B.V. (“PTI Finance”, an entity not included in the transaction perimeter);

- (b) a dividend distribution of €44.0 million from PT Participações to PT Móveis and with these proceeds PT Móveis shall acquire the investments in Hungaro Digitel, PLC (“Hungaro Digitel”) and SIRESP, Gestão de Redes Digitais de Segurança e Emergência, S.A. (“SIRESP”) (both entities are included in the target assets) previously held by PT Participações, SGPS, S.A. (“PT Participações”, an entity not included in the transaction perimeter), for total amounts of €34.0 million and €10.0 million, respectively;
- (c) sale by PT Móveis to Oi of its investments in shares of PT Participações, CV TEL and Carrigans Finance S.A.R.L (“Carrigans”) (all three entities are not included in the target assets) for a total amount of €1,549.0 million, prior to which PT Portugal shall reduce its share capital in favor of Oi through the assignment of a receivable from PT Móveis amounting to €1,549.0 million that shall be used to settle the above-mentioned sale. Those transactions do not produce an impact in the unaudited combined pro forma balance sheet because these investments had already been eliminated in the combined adjusted balance sheet;
- (d) sale by PT Portugal to Oi of its investment in shares of PTI Finance for a total amount of €255.0 million, prior to which PT Portugal shall reduce its share capital in favor of Oi by the same amount; this transaction did not produce an impact in the combined pro forma balance sheet because this investment had already been eliminated in the unaudited combined adjusted balance sheet;
- (e) transfer by PT Portugal of its existing €200.0 million Rio Forte receivable to PTI Finance by offsetting against €200.0 million of debt due from PT Portugal to PTI Finance; this transaction did not produce an impact in the combined pro forma balance sheet because the Rio Forte receivable had already been eliminated in the combined adjusted balance sheet;
- (f) sale by PT Investimentos Internacionais, Consultoria Internacional, S.A. (“PT Investimentos”, an entity not included in the transaction perimeter) of its shares in Taguspark—Sociedade de Promoção e Desenvolvimento do Parque de Ciência e Tecnologia da Área de Lisboa, S.A. (“Tagusparque”) and APOR—Agência para a Modernização do Porto, S.A. (“APOR”) to PT Portugal for a total amount of €3.0 million, by offsetting a portion of the €5.0 million debt due from PT Investimentos to PT Portugal, with the remaining portion of the €2.0 million debt due from PT Investimentos being transferred from PT Portugal to PTI Finance BV by offsetting a portion of the debt due by PT Portugal to PTI Finance BV;
- (q) sale by PT Portugal to Oi of its investment in shares of PT Investimentos for €7.0 million, prior to which PT Portugal shall reduce its share capital in favor of Oi by the same amount; this transaction did not produce an impact in the combined pro forma balance sheet because this investment had already been carve-out in the combined adjusted balance sheet;
- (h) Transfer to Oi of PT Portugal’s EMTN Notes due to third-party lenders, totalling € 404.5 million (principal of €404.0 million and €4.5 million of accrued interest), as a result of which this debt is replaced at PT Portugal by an intercompany debt to Oi of the same amount;
- (i) Capitalization of a €321 million portion of New Loan held by Oi against PT Portugal into the share capital of PT Portugal in exchange for shares issued by the latter, as a result of which the loan due by PT Portugal to Oi is decreased from €404 million to €83 million; and
- (j) A loan granted by PT Móveis to Siresp amounting to €1.2 million, amount that was used by Siresp to repay its debt due to PT Participações of the same amount.

The table below presents a summary of the effects on the balance sheet as of September 30, 2014 resulting from the corporate transactions to be completed prior to the closing of the acquisition of PT Portugal by Altice:

Adjustments to the combined proforma balance sheet as of September 30, 2014	Notes above	Cash and cash equivalents	Investments in group and associated companies	Investments in intercompany loans	Other investments	Medium and long term debt	Total corporate transactions
Settlement of intercompany loans granted by PT							
Móveis to CV TEL	(a)	—	—	(3,401.0)	—	(3,401.0)	—
Dividend distribution by PT							
Participações to PT							
Móveis.....	(b)	44.0	(44.0)	—	—	—	—
Acquisition of Hungaro							
Digitel	(b)	(34.0)	34.0	—	—	—	—
Acquisition of Siresp	(b)	(10.0)	10.0	—	—	—	—
Acquisition of Tagusparque and Apor	(f)	—	—	(3.0)	3.0	—	—
Settlement of intercompany loans granted by PT							
Portugal to PT							
Investimentos	(f)	—	—	(2.0)	—	(2.0)	—
Capitalization of a portion of debt due to Oi.....	(i)	—	—	—	—	(321.0)	321.0
Loan granted to Siresp	(j)	(1.2)	—	—	—	—	(1.2)
		(1.2)	—	(3,406.0)	3.0	(3,724.0)	319.8

MANAGEMENT'S DISCUSSION AND ANALYSIS OF FINANCIAL CONDITION AND RESULTS OF OPERATIONS OF THE GROUP

The following discussion and analysis is intended to assist in providing an understanding of the Group's financial condition, changes in financial condition and results of operations and should be read together with the Historical Consolidated Financial Information, with the Pro Forma Financial Information and the Illustrative Aggregated Selected Financial Information, including the accompanying notes, included elsewhere in these Listing Particulars. Some of the information in this discussion and analysis includes forward-looking statements that involve risks and uncertainties. See "Forward-looking statements" and "Risk Factors" for a discussion of important factors to be evaluated in connection with an investment in the Notes.

In this section, we use "pro forma basis" and "aggregated basis" or similar terms to describe financial information derived from the Pro Forma Financial Information or the Illustrative Aggregated Selected Financial Information as the case may be. When used in this section, the terms "we", "our", "Altice International", "Company", the "Group", and "us" refer to the business constituting the Group (excluding PT Portugal, and other than for the purposes of comparing the results of operations and capital expenditures for the nine months ended September 30, 2014 versus the nine months ended September 30, 2013, ODO) as of the date of these Listing Particulars even though we may not have owned such business for the entire duration of the periods presented. Since Altice International did not consolidate the results of ODO for any periods prior to April 9, 2014 and only commenced presenting the Dominican Republic as a separate geographic segment after such date, the results of ODO for the years ended December 31, 2013, 2013 and 2011 have been discussed separately in these Listing Particulars. See "Management's Discussion and Analysis or Financial Condition and Results of Operations of ODO for the Years Ended December 31, 2013, 2012 and 2011".

In the subsections "—Year Ended December 31, 2013 compared to the Year Ended December 31, 2012" and "—Capital Expenditures—Capital expenditures on a Pro Forma Consolidated Basis and Aggregated Basis—Year Ended December 31, 2013 compared to the Year Ended December 31, 2012" below, we compare certain financial information as of and for the year ended December 31, 2012 derived from the Illustrative Aggregated Selected Financial Information with the corresponding financial information as of and for the year ended December 31, 2013 derived from the Pre-PT/ODO Transactions Pro Forma Financial Information. While we do not present any pro forma financial information for the year ended December 31, 2012, the adjustments used to prepare the selected information included in the Illustrative Aggregated Selected Financial Information for the year ended December 31, 2012 are substantially similar to the adjustments used to prepare the corresponding information in the Pre-PT/ODO Transactions Pro Forma Financial Information for the year ended December 31, 2013 and therefore a comparison between the Illustrative Aggregated Selected Financial Information for the year ended December 31, 2012 and the corresponding information in the Pre-PT/ODO Transactions Pro Forma Financial Information for the year ended December 31, 2013 is on a like-for-like basis for items above EBITDA. However, we do not present any Illustrative Aggregated Selected Financial Information below the line item "operating income before depreciation, amortization, restructuring costs and other expenses", or EBITDA, and therefore do not compare any such financial information appearing in the Pre-PT/ODO Transactions Pro Forma Financial Information. In addition, the Illustrative Aggregated Selected Financial Information does not provide for certain pro forma adjustments included in the Pre-PT/ODO Transactions Pro Forma Financial Information which affect the line items in the pro forma income statement below "operating income before depreciation and amortization", or EBITDA.

Basis of Presentation

This discussion and analysis for each of the periods presented is based on the financial information derived from the unaudited condensed consolidated financial statements of Altice International as of and for the nine months ended September 30, 2014 and 2013, and the audited consolidated financial statements of Altice International as of and for the years ended December 31, 2013 and 2012 (including comparative numbers as of and for the year ended December 31, 2011) (the "Historical Consolidated Financial Information").

Altice International is a holding company which, since its formation in 2008, has from time to time made significant equity investments in a number of cable and telecommunication businesses in various jurisdictions. The following is an overview of key investments and disposals made by Altice International since 2010, which have had a significant impact on the Historical Consolidated Financial Information.

During the year ended December 31, 2011, Altice International made the following acquisitions that fundamentally changed the business undertaking: (i) in the first quarter of 2011, Altice International increased its ownership in HOT-Telecommunication Systems Ltd. thereby acquiring a majority equity ownership in the HOT Telecom Group (as a result of which the financial information of the HOT Telecom Group is consolidated in the Historical Consolidated Financial Information of Altice International with effect from March 16, 2011). In addition, in the fourth quarter of 2011, MIRS Communications Ltd. was acquired by the HOT Telecom Group from a subsidiary of Altice International and renamed HOT Mobile Ltd. The HOT Telecom Group and HOT Mobile Ltd. are collectively referred to herein as the

“HOT Group”; and (ii) in the second quarter of 2011, Altice International acquired a controlling equity interest in Coditel Brabant S.p.r.l, a company with cable television operations in Belgium and Coditel S.à r.l., a company with cable television operations in Luxembourg, in each case, through an intermediate holding company, Coditel Holding S.A. (the financial information of which is consolidated in the Historical Consolidated Financial Information of Altice International with effect from July 1, 2011). In addition, Altice International sold 5% of its equity interest in MIRS Communications Limited during the course of 2011.

The year ended December 31, 2012 was marked by the following two significant acquisitions by Altice International: (i) in the first quarter of 2012, Altice International acquired approximately 60% of the equity interests in Cabovisão, a Portuguese telecommunications company (the financial information of which is consolidated in the Historical Consolidated Financial Information of Altice International with effect from February 29, 2012); and (ii) in the fourth quarter of 2012, Altice International completed the take-private transaction of the HOT Group whereby it acquired substantially all of the equity interests in HOT-Telecommunication Systems LTD. it did not previously own.

Altice International added to its portfolio of holdings in 2013 with the following acquisitions: (i) in the first quarter of 2013, Altice International acquired substantially all of the equity interests in Cabovisão that it did not already own; (ii) in the third quarter of 2013, Altice International acquired a controlling equity interest in Groupe Outremer Telecom, a telecommunications company with operations in the French Overseas Territories (the financial information of which is consolidated in the Historical Consolidated Financial Information of Altice International with effect from July 5, 2013); and (iii) in the third quarter of 2013, Altice International (through its subsidiary Cabovisão) acquired 100% of the equity interests in Winreason, the owner of the Portuguese telecommunications operator holding company ONI S.G.P.S. and its subsidiaries (the financial information of which is consolidated in the Historical Consolidated Financial Information of Altice International with effect from August 8, 2013) and (iv) in November 2013, Altice International acquired further equity interests in Coditel pursuant to the 2013 Coditel Acquisition. In addition, in 2013, we disposed of our interests in Valvision and acquired the content subsidiaries, Ma Chaîne Sport, SportV, Tricom, Mobius and ODO. In addition, during 2013 Altice International initiated its equity investment in Wananchi (“Wananchi”), a Kenyan cable operator.

In 2014, Altice International consummated the acquisitions of (i) Tricom (the financial information of which is consolidated in the Historical Consolidated Financial Information of Altice International with effect from March 12, 2014), (ii) ODO (the financial information of which is consolidated in the Historical Consolidated Financial Information of Altice International with effect from April 9, 2014) and (iii) Mobius (the financial information of which is consolidated in the Historical Consolidated Financial Information of Altice International with effect from January 1, 2014). On December 9, 2014, we entered into an agreement with Oi S.A. to purchase 100% of the issued share capital of PT Portugal. In addition, in connection with the acquisition of SFR by Numericable Group (which is indirectly controlled by our parent Altice S.A., and therefore an affiliate of the Group), we have entered into a commitment agreement with the French Competition Authority to dispose of our mobile network assets in Mayotte and La Réunion (which are part of our Group’s business in the French Overseas Territories and which in aggregate contributed €10 million to aggregated and pro forma EBITDA for the fiscal year ended 2013.). If this disposal is not completed by mid-2015, we are committed to appoint an independent agent (who must be approved by the French Competition Authority) to complete such disposal. Further, we have undertaken to ensure that such mobile assets in La Réunion and in Mayotte are managed independently from the other activities of Numericable Group (including those of SFR) prior to such disposal. We expect that the disposal of the mobile network assets of OMT in Mayotte and La Réunion will reduce the overall leverage of the Group.

As a result of the series of these significant acquisitions that have been consummated by Altice International since 2011, and the intra-year timing of such acquisitions, the Historical Consolidated Financial Information does not consolidate the results of operations of the entire business undertaking of the Group as it existed as of September 30, 2014 for any of the periods presented and the comparability of the Historical Consolidated Financial Information over each of the periods presented may be significantly limited. Therefore, in order to facilitate an understanding of the Group’s results of operations and financial condition, this discussion and analysis is being supplemented by the following information:

For the nine months ended September 30, 2014 and the nine months ended September 30, 2013

- (i) financial information derived from the unaudited pro forma consolidated interim financial information of Altice International for each of the nine-months periods ended September 30, 2013 and 2014, giving effect to each of the significant acquisitions described above (but without giving effect to the PT Portugal Acquisition, the disposal of our mobile network assets in Mayotte and La Réunion which we have committed to undertake and, except as described below, without giving pro forma effect to the Tricom Acquisition or the Mobius Acquisition) (the “Pre-PT Transaction Pro Forma Financial Information”);

For the years ended December 31, 2013, 2012 and 2011

- (ii) financial information derived from the unaudited pro forma consolidated financial statements of Altice International for the year ended December 31, 2013, giving effect to each of the significant acquisitions

described above (but without giving effect to the PT Portugal Acquisition, the ODO Acquisition, the Tricom Acquisition, the Mobius Acquisition or the disposal of our mobile network assets in Mayotte and La Réunion which we have committed to undertake) (the “Pre-PT/ODO Transactions Pro Forma Financial Information” and, together with the “Pre-PT Transaction Pro Forma Financial Information”, the “Pro Forma Financial Information”); and

- (iii) financial information derived from the Illustrative Aggregated Selected Financial Information as of and for the years ended December 31, 2011 and 2012 (the “Illustrative Aggregated Selected Financial Information”), which aggregates financial information of each of the business undertakings the acquisition of which was consummated by Altice International prior to December 31, 2013 (but does not include the financial information of PT Portugal, ODO, Tricom or Mobius).

For further details regarding the basis of presentation of the Pro Forma Financial Information and the Illustrative Aggregated Selected Financial Information, please see basis of preparation to the Pro Forma Financial Information and the Illustrative Aggregated Selected Financial Information, respectively, included elsewhere in these Listing Particulars.

With effect from March 12, 2014, and January 1, 2014, respectively, the financial information of Tricom and Mobius have been consolidated in the Historical Consolidated Financial Information of Altice International. As a result, the Pro Forma Financial Information also consolidates the financial information of Tricom and Mobius from March 12, 2014 and January 1, 2014, respectively, but does not give pro forma effect to the Mobius Acquisition or the Tricom Acquisition for any other periods. The Pro Forma Financial Information and the Illustrative Aggregated Selected Financial Information also includes the results of operations of Valvision even though the Group disposed of its interests in Valvision to the Numericable Group on June 27, 2013. In each of the years ended December 31, 2013, 2012 and 2011, respectively, Valvision contributed €1.3 million, €2.5 million and €2.6 million to pro forma revenues and €0.5 million, €0.9 million and €0.9 million to pro forma EBITDA. In the nine months ended September 30, 2013, Valvision contributed € 1.3 million to pro forma revenues and €0.5 million to pro forma EBITDA.

As we control Coditel Holding through which we conduct our operations in Belgium and Luxembourg, we consolidate 100% of their revenue and expenses in our consolidated income statements despite the fact that third parties own or owned significant interests in this entity. The non-controlling owners’ interests in the operating results of Coditel Holding in the Historical Consolidated Financial Information and the Pro Forma Financial Information are reflected in the line item “profit or loss attributable to non-controlling interests” in the relevant statements of income. However, since we do not present any Illustrative Aggregated Selected Financial Information below the line item “operating income before depreciation and amortization”, or EBITDA, the non-controlling interests in the operating results of Coditel Holding are not reflected anywhere in the Illustrative Aggregated Selected Financial Information. Such non-controlling interests may be significant. The Pro Forma Financial Information and the Illustrative Aggregated Selected Financial Information have not been prepared in accordance with IFRS and are unaudited.

Geographic Segments

We have historically discussed the results of operations of our businesses based on the following geographic segments: Israel (which includes HOT and HOT Mobile); Belgium and Luxembourg (which includes Coditel); Portugal (which includes Cabovisao and ONI); the French Overseas Territories (which includes Outremer and Le Cable) and Others (which include our B2B telecommunications solutions business and datacenter operations in Switzerland (Green and Green Datacenter), our datacenter operations in France (Auberimmo) and our content production and distribution businesses in France and Luxembourg (Ma Chaîne Sport and SportV). Following the acquisition of ODO in April 2014, we have added the Dominican Republic as a new geographic segment for the purposes of the discussion of our results for the nine months ended September 30, 2014 and the comparative period in 2013 (but not for any prior period). Currently, the Dominican Republic segment only reflects the results of ODO. We also acquired Tricom in the Dominican Republic in March 2014. The result of Tricom have been included in the Others segment with effect from March 12, 2014. Following the acquisition of Mobius, with effect from January 1, 2014, Mobius has been included in the French Overseas Territories segment.

Key Factors Affecting Our Business

Our operations and the operating metrics discussed below have been, and may continue to be, affected by certain key factors as well as certain historical events and actions. The key factors affecting the ordinary course of our business and our results of operations include, among others, network upgrades, including the roll-out of our UMTS network in Israel and the concurrent phase-out of the old iDEN technology, competition, acquisitions and integration of acquired businesses, macro-economic and political risks in the areas where we operate, pricing, our cost structure, churn and the introduction of new products and services, including multiple-play services. For further discussions of the factors affecting our results of operations, see “*Risk Factors*”.

Acquisitions and Integration of Businesses

Since our formation in 2008, we have from time to time made significant direct and indirect equity investments in a number of cable and telecommunication businesses in various jurisdictions. Due to the significant nature of certain of these acquisitions, the comparability of our results of operations based on the Historical Consolidated Financial Information is limited. Our revenues and EBITDA increased from €784.2 million and €297.8 million in the year ended December 31, 2011 to € 1,286.8 million and €518.8 million in the year ended December 31, 2013, mainly as a result of the impact of such acquisitions. See “—*Basis of Presentation*”. We plan to continue to evaluate value-enhancing acquisition opportunities in the cable and telecommunication sector with the aim of generating strong cash flow and operational synergies.

In general, following any acquisition, our results of operations are impacted by the results of the newly acquired business, debt incurred to acquire the business and expenditures made to integrate the newly acquired business into the Group. When seeking to integrate and improve a newly acquired business, we look to several key areas: (i) reviewing current products and prices and improving operational processes and cost structure to achieve satisfactory operating margins; (ii) implementing cable and mobile network upgrades to bring the acquired business in line with our Group-wide standards; (iii) researching ways to create synergies and benefit from economies of scale including with respect to customer equipment such as set-top boxes and outsourcing of certain services; (iv) sharing knowledge and experience and implementing Group-wide best practices; and (v) leveraging our ability to raise financing, including in the international capital markets. Many of these integration measures require expenditure by us. In the year ended December 31, 2013 and the nine months ended September 30, 2014, respectively, we incurred restructuring and other non-recurring costs of €76.3 million and €58.5 million, which primarily include costs with respect to renegotiations or termination of contractual arrangements, employee redundancies, fees paid to external counsel and other administrative expenses related to re-organization of existing or newly acquired businesses. In addition, we generally record goodwill in connection with such acquisitions. As of September 30, 2014, the goodwill recorded on our balance sheet amounted to €2,050 million. Goodwill is subject to impairment reviews in accordance with IFRS and any impairment charge on goodwill would have a negative impact on operating profit/net operating income.

Network Upgrades

Our ability to provide new or enhanced cable-based services, including HDTV and VoD television services, broadband internet network access at increasing speeds and fixed-line telephony services to additional subscribers depends in part on our ability to upgrade our cable networks by extending the fiber portion of our network, reducing the number of nodes per home passed and upgrading technical components of our network. During each of 2012 and 2013, we deployed fiber on and upgraded a substantial part of our cable networks. As of September 30, 2014, our networks, on a blended basis, are 99.5% Docsis 3.0 enabled, which allows us to offer our customers high broadband internet access speeds and better HDTV services across our regions, excluding the Dominican Republic. For the nine months ended September 30, 2014 and for the year ended December 31, 2013, on a pro forma basis, we invested €53.2 million and €57.5 million, respectively, and for the year ended December 31, 2011 and 2012, on an aggregated basis, we invested €58.1 million and €76.8 million, respectively, in cable network and construction related capital expenditures. We continue to evaluate the need to upgrade our networks for advancements in technologies such as Docsis 3.1 and for the deployment of additional fiber on an ongoing basis.

In May 2012, we launched our UMTS network in Israel, which allows us to offer 3G mobile services to our customers in Israel under the “HOT Mobile” brand. Under the terms of our license, among other things, we have committed to provide UMTS network coverage to 90% of the Israeli population and inhabited territory by 2018. Our network already extends to approximately 56% of the inhabited territory of Israel. For the nine months ended September 30, 2014 and for the year ended December 31, 2013, we invested € 22.8 million and €83.8 million, respectively, in capital expenditures in our mobile business in Israel, of which most related to the build out of our UMTS network (and if we are successful, in connection with the tender for LTE frequencies built on our 4G LTE network). In November 2013 we entered into the Network Sharing Agreement with Partner pursuant to which HOT Mobile and Partner will own equal shares of a newly formed limited partnership, which shall hold, develop and operate an advanced shared mobile network for both companies. The Network Sharing Agreement will enable HOT Mobile and Partner to share antennas and frequencies and facilitate optimum utilization of the spectrum. Accordingly, we expect that the Network Sharing Agreement will optimize the amount of capital expenditures we incur in relation to the build-out of our UMTS network. The Network Sharing Agreement has received approval from the Israeli Antitrust Authority (subject to certain conditions) but remains subject to final approval from the Israeli Ministry of Communications and any required agreement or regulation. See “*Description of Our Business—Material Contracts—Mobile Network Sharing Agreement with Partner in Israel*”.

In Israel, on July 2, 2014, the Ministry of Communications published a tender for a mobile phone license for the provision of advanced services using 4G-LTE technology, through which a total of eight frequency bands in the area of 1,800 MHz will be allocated. The tender conditions clarified that a licensee may enter into a network sharing agreement with another licensee subject to certain conditions, as a result of which HOT Mobile updated its request for approval by

the Ministry of Communications of the Network Sharing Agreement with Partner. On November 18, 2014, HOT Mobile submitted its offer in response to the tender. On January 12, 2015, the Israeli Ministry of Communications informed HOT Mobile that based on the results of the tender it would be awarded a frequency bandwidth of 2X5MHz in the 1.8 GHz spectrum, for a license fee of NIS 34.5 million (up to half of which may be paid by way of provision of a bank guarantee, which may be refunded, in whole or in part, upon HOT Mobile reaching certain market share milestones). The tender results will be brought before the Minister of Communications for approval. It is also expected that ARCEP will initiate an application process to award spectrum for the provision of LTE mobile telephony services in the French Overseas Territories in the near term. In the event of a successful tender bid, our ability to provide LTE mobile services to complement our existing mobile services in Israel and the French Overseas Territories respectively will depend in part on our ability to upgrade our mobile network and roll out an LTE network, which would involve additional capital expenditure or, subject to regulatory approval, investment in the newly formed limited partnership to be set up in Israel pursuant to the Network Sharing Agreement between HOT Mobile and Partner. In Israel, because of our extensive fixed line network and the technologically advanced nature of our UMTS network, as well as the Network Sharing Agreement, we believe upgrading our mobile network to the LTE standard will require lesser investment as compared to some of our competitors and significantly less capital expenditure than we incurred to roll out our UMTS network.

Competition

Our Cable Customer Relationships, RGUs and ARPU are impacted by the levels of competition we experience in each of our regions. Although we increased our total cable RGUs in 2012, our total cable RGUs declined by 87,000 (or 2.6%) for the year ended December 31, 2013 and by 56,000 RGUs (or 1.8%) for the nine months ended September 30, 2014, due to significant competition in most of the regions in which we operate. In Portugal, we experienced increased churn and a decline in total cable RGUs and ARPU in the nine months ended September 30, 2014, and in the twelve months ended December 31, 2013, mainly as a result of aggressive competition and adverse economic conditions as well as our strategic decision to cease offering certain aggressively-priced packages and to migrate customers to our triple-play offerings, in order to maintain our EBITDA margins, which resulted in an erosion of our subscriber base. Furthermore, in Belgium, we also experienced a decline in total cable RGUs in the nine months ended September 30, 2014 and the twelve months ended December 31, 2013, resulting from a net decrease in digital television RGUs, partially due to customers churning to different platforms such as digital television providers over DSL and satellite operators. We expect competitive pressures to intensify in each of our regions due to a variety of factors. For example, in Israel, we expect to experience an increase in competition particularly with respect to the broadband internet services as a result of an increase in speeds offered by the incumbent operator. Further, the number of total mobile subscribers declined in the French Overseas Territories in 2013 and in the nine months ended September 30, 2014, primarily due to intense competition. For details regarding our key competitors, please see “*Industry and Market Overview*”. Our ability to increase or maintain the prices for our cable and mobile services, and therefore our ARPU, is also limited by regulatory factors in each of the regions in which we operate.

In Israel, the Israeli Ministry of Communications has in recent years taken certain measures to increase the competition in the telecommunications industries, including the establishment of a DTT platform with the possibility of expanding the number of channels broadcasted over such platform, eliminating exit fees for subscribers except in limited circumstances and prohibiting the linkage of the price and terms of a handset to mobile services or benefits. In 2014, the Israeli Ministry of Communications also introduced a policy for the establishment of a wholesale market for broadband internet infrastructure access pursuant to which certain limitations on structural separation and bundling of products may be reduced, but we would also be required to provide access to our network infrastructure to other service providers on a wholesale basis. The price for such access would be determined based on a commercial agreement between us and any such service provider, but the Israeli Minister of Communications will be entitled to intervene in the determination of the terms or the price that have been agreed or that is demanded by us if it should find that such price is either unreasonable or could harm the competition, or if we have been unable to enter into a commercial agreement with the service provider. The Israeli Ministry of Communications has also introduced a policy for the establishment of a wholesale market for broadband Internet infrastructure access pursuant to which certain limitations on structural separation and bundling of products may be reduced, but we would also be required to provide access to our network infrastructure to other service providers on a wholesale basis. The price for such access would be determined based on a commercial agreement between us and any such service provider, but the Israeli Minister of Communications will be entitled to intervene in the determination of the terms or the price that have been agreed or that is demanded by us if it should find that such price is either unreasonable or could harm the competition, or if we have been unable to enter into a commercial agreement with the service provider. Further, the Israeli Ministry of Communications has issued regulatory instructions, including the method of setting wholesale service rates and, in the case of Bezeq, the maximum rates that can be collected by Bezeq from other license holders who make use of its infrastructure for the years 2014 to 2018, in an attempt to create a wholesale market for broadband Internet infrastructure access and fixed line telephony services which would allow service providers (such as ISPs, VOB providers and IPTV providers) to provide services to their customers by using our cable network. Should the wholesale market develop, certain requirements for structural separation and bundling of products that apply to Bezeq and us may be lifted, and thus competition in the broadband Internet infrastructure access market may increase significantly which could negatively affect our results of operations. See “*Risk Factors—Risks*”

Relating to Legislative and Regulatory Matters—Israel—We are subject to significant government regulation and supervision, which could require us to make additional expenditures or limit our revenues and otherwise adversely affect our business, and further regulatory changes could also adversely affect our business”.

The competition we face in our markets, as well as any decline in the economic environment, could adversely impact our ability to increase or maintain our revenue, RGUs, operating cash flow or liquidity. We currently are unable to predict the extent of any of these potential adverse effects on our results of operations.

In addition, the cable services and mobile telephony industries typically exhibit churn as a result of high levels of competition, which could lead to increased costs and reduced revenue. Our churn levels may be affected by a variety of factors including changes in our or our competitors’ pricing, our level of customer satisfaction, disconnection of non-paying subscribers and changes in regulations. Churn rates in the cable segment in our individual markets are also impacted by customers moving out of our network area, although our nationwide network in Israel, allows us to minimize the impact of our customers moving homes as there is a high likelihood that such customer will move into a home passed by our cable network or that could be connected to our cable network without materially extending our cable network plan. We could in some instances incur some capital expenditures related to installation and connection of such relocating customers. With respect to our mobile business, in Israel, prior to the launch of our UMTS based 3G services in May 2012, our churn rates have increased in recent years as subscribers left our iDEN-based network for the more advanced networks of our competitors. Our churn rates further increased in our mobile sector in Israel in 2012 as our contract with the Israeli Defense Force for the provision of iDEN-based mobile services terminated in the last quarter of 2012, but were partially offset by certain of our iDEN subscribers switching to our 3G services launched in May 2012 as opposed to those offered by our competitors. The gradual migration of the iDEN subscribers under the expired contract with the Israeli Defense Forces to the new service provider was completed in March 2013. With the launch of our UMTS network, we expect that our mobile churn rate in Israel will increase from historical levels as 3G mobile services generally have a higher churn rate than iDEN mobile services. In addition, regulatory actions of the Israeli Ministry of Communications which have increased competition by prohibiting exit fees, except in limited circumstances, long-term commitments and, as of January 2013, the linkage of the price and terms of handsets to the mobile service prices and benefits are also likely to have an impact on mobile churn rates in Israel. In Portugal, we experienced an increase in churn in recent periods mainly as a result of aggressive competition and adverse economic conditions. Business customer retention is generally high compared to the retention of residential customers as switching service providers in the short term can be difficult and costly especially for large corporate customers. Our long term business customer relationships in Portugal (our largest B2B market) usually last on average for six years with contract terms ranging between 24 to 36 months.

On December 29, 2014, Cellcom, an Israeli telecommunication company, which also offers mobile services, announced the launch of “Cellcom TV”, its new service for offering television over the internet. Cellcom TV services include the Israeli DTT broadcasting television channels, VOD services and additional advanced features and viewing capabilities. Although this service was only recently introduced (and, as such, we are unable to fully anticipate the effect that this development may have on HOT), we expect that it may increase the competition in the television services market in which HOT currently operates, and as such could have a material effect on our business, financial condition and results of operations.

Multiple-Play Strategy

We have implemented a product offering across the regions in which we operate with a strategic focus on multiple-play, including triple-play bundles. Subscribers who elect to subscribe for our multiple-play bundles realize cost savings on their monthly bill as compared to purchasing each of the services individually. We believe that offering bundled services allows us to meet customers’ communication and entertainment requirements increases customer loyalty and attracts new customers as the value proposition of the offering is enhanced. As a result of our focus on providing subscribers with multiple-play bundles, we have experienced an increase in the number of Cable Customer Relationships subscribing for our triple-play services, with the number of triple-play subscribers increasing from 560,000 as of December 31, 2011, to 693,000 as of September 30, 2014, which has driven growth in our cable based services ARPU (other than in Portugal where our ARPU was negatively impacted in 2013 and the nine months ended September 30, 2014, by aggressive competition and adverse economic conditions). Our cable-based services ARPU for the years ended December 31, 2011, 2012 and 2013 and for the nine months ended September 30, 2013 and 2014, respectively, were €42.4, €44.4, €47.6, €47.6 and €48.8 in Israel, €36.7, €39.5, €41.9, €41.1 and €43.6 in Belgium and Luxembourg, €36.9, €34.9, €34.6, €35.1 and €33.4 in Portugal and €43.1, €48.3, €51.4, €50.8 and €55.6 in the French Overseas Territories.

Introduction of New Products and Services

We have significantly expanded our presence and product and service offerings in the past. HOT has been a leader in bringing cable-based services to the Israeli market. HOT launched digital cable television in 2001, high-speed broadband internet infrastructure access in 2003 and cable-based fixed telephony services in 2005. HOT has continued to enhance its product and service offerings, being the first company to introduce VoD services in Israel in 2005 and launching a 100 Mbps broadband internet service in 2010. In May 2012, we launched UMTS-based 3G mobile services in Israel. We have taken similar measures in the other countries in which we operate including introducing mobile services in Belgium, launching our most advanced set top boxes, LaBox after the successful introduction in Belgium and Luxembourg (2012), Portugal (2012) and Israel (as “FiberBox” in March 2014). In the French Overseas Territories, Outremer pioneered flat-fee rate mobile telephony plans by introducing packages with unlimited calls to the French Overseas Territories and mainland France in 2012. In addition, we regularly review and invest in the content we offer in order to provide our subscribers with a flexible and diverse range of programming options, including high-quality local content and exclusive premium content. The introduction of new products and services have impacted our result of operations in the periods presented, by among other things, opening new revenue streams (e.g. 3G mobile services in Israel and Belgium) and, in certain cases, increasing operating expenses and capital expenditures (e.g. UMTS network build out costs and roaming costs in Israel relating to our 3G mobile services and costs relating to the roll-out of the LaBox in Western Europe).

Pricing

We focus our product offering on multiple-play offers. In Israel, we believe our ability to offer triple-play services provides us with a competitive price advantage. The cost of a multiple-play subscription package generally depends on market conditions and pricing by competitors with similar offerings. In addition, pricing depends on the content and options available on each platform (i.e. number of regular and premium channels offered for television, maximum speed for broadband internet, regular and long-distance minutes for fixed-line telephony, and number of voice minutes and text messages for mobile telephony). Subject to certain exceptions such as our flat-fee rate plans in the French Overseas Territories which we introduced in the first half of 2012, the more options, content and included usage time, the higher the price of the multi-play package or stand-alone offering in question. We adjust our pricing policies based on evolving market practices as well as the Group’s overall business strategy. For example, in Belgium we increased the prices for our triple-play and stand-alone products in 2012 in line with the market which has resulted in an increase in cable-based ARPU, while in Portugal, during the course of 2012, we took the strategic decision to cease offering certain aggressively-priced packages and to migrate customers to our triple-play offerings, in order to maintain our EBITDA margins, which resulted in an erosion of our subscriber base. Our ability to increase or maintain the prices for our cable and mobile services, and therefore our ARPU, is also limited by regulatory factors in each of the regions in which we operate. Prices for B2B contracts are negotiated with each customer. The B2B market for voice services is extremely price sensitive and very low margin, as voice services are highly commoditized, with sophisticated customers and relatively short-term contracts. The B2B market for data services is less price sensitive, as data services require more customization and service level agreements. In both markets, price competition is strongest in the large corporates segment and public sector, whereas customer-adapted solutions are an important competitive focus in the medium and smaller business segment.

Cost Structure

We generally work towards achieving satisfactory operating margins in our businesses and focus on revenue-enhancing measures once we have achieved such margins. We continuously work towards optimizing our cost base by implementing initiatives to improve our cost structure across the various regions in which we operate. We are implementing common technological platforms across our networks in order to gain economies of scale, notably with respect to billing systems, network improvements and cable customer premises equipment. We have also achieved and expect to continue to achieve substantial reductions in our operating expenses as we implement the same best practice operational processes across our organization. We have simplified the services we offer, increased the level of outsourcing of customer service, customer installations and network maintenance and reduced costs through the negotiation of attractive interconnection rates and improved pricing of the same television content. As a result, we have generally managed to achieve growth in EBITDA, profitability and operating cash flow of businesses we have acquired. For example, in our Israeli business, following the acquisition by Altice International of HOT in 2011, HOT’s cable EBITDA margin increased to 55.1% in 2013 from 41.8% in 2011. Likewise, in our Portuguese business, following the acquisition by Altice International of Cabovisão in February 2012, Cabovisão’s EBITDA margin increased to 39.9% in 2013 compared to 14.2% in 2011. In our Dominican Republic business, following the acquisition by Altice International of ODO in April 2014, ODO’s EBITDA margin increased to 47.8% for the nine months ended September 30, 2014 compared to 38.9% for the nine months ended September 30, 2013.

We make expansion-related capital expenditure decisions by applying strict investment return and payback criteria. For the nine months ended September 30, 2014 and for the year ended December 31, 2013, respectively, we incurred capital expenditure of €315.1 million and €314.2 million, in each case on a pro forma basis. Of such capital expenditures,

approximately 21.0% and 22.6% related to CPE and installations cable capital expenditures, 16.9% and 18.3% related to our cable network and construction, 21.1% and 24.3% related to other cable capital expenditures, 26.5% and 19.7% related to capital expenditures for our mobile businesses and 14.5% and 15.1% related to B2B and other capital expenditures in each case for the nine months ended September 30, 2014 and the year ended December 31, 2013, respectively.

We have recently incurred significant capital expenditures related to the building-out and launching of our UMTS network in Israel as well as significant operating expenditures, including national roaming costs pursuant to our roaming arrangement with Pelephone. In November 2013 we entered into the Network Sharing Agreement with Partner pursuant to which HOT Mobile and Partner will each own equal shares of a newly formed limited partnership, which is expected to hold, develop and operate an advanced shared mobile network for both companies. The Network Sharing Agreement is valid until December 31, 2028 and has received approval from The Israeli Antitrust Authority (subject to certain conditions) but remains subject to final approval from the Israeli Ministry of Communications. This agreement will enable HOT Mobile and Partner to share antennas and frequencies and facilitate optimum utilization of the spectrum. In the interim, HOT Mobile has entered into the RoU Agreement with Partner which gives HOT Mobile a right of use over Partner's mobile communication network for the purpose of providing nation-wide mobile coverage to our customers. In connection with our entry into the Network Sharing Agreement and the RoU Agreement, HOT Mobile and Pelephone amended their underlying agreement in December 2013 repealing the exclusivity clause which HOT Mobile was subject to. This amendment will allow HOT Mobile to exercise its rights under the Network Sharing Agreement with Partner (once final approval from the Israeli Ministry of Communications has been given) and we expect that the arrangements we have entered into with Partner will result in savings related to network and maintenance expenses and optimize the amount of capital expenditures we are required to incur in relation to the build-out of our UMTS network. We have already experienced savings relating to roaming costs under our RoU Agreement for the nine months ended September 30, 2014; however there can be no assurance that we will be able to obtain the required the outstanding regulatory approvals or otherwise be able to implement the other arrangements we have entered into with Partner in a timely or cost effective manner. For further details, see "*Description of Our Business—Material Contracts—Mobile Network Sharing Agreement with Partner in Israel*".

Macro Economic and Political Developments

Our operations are subject to macro-economic and political risks that are outside of our control. For example, high levels of sovereign debt in the U.S., certain European countries and countries in the Middle East, combined with weak growth and high unemployment, could lead to low consumer demand, fiscal reforms (including austerity measures), sovereign debt restructurings, currency instability, increased counterparty credit risk, high levels of volatility and, potentially, disruptions in the credit and equity markets, as well as other outcomes that might adversely impact our financial condition. For example, our results of operations in the period under review have been affected by adverse economic conditions and austerity measures in Portugal which had a negative effect on consumer confidence. Moreover, in Israel, we are subject to the inherent risks associated with the political and military conditions there and the potential for armed conflicts with Israel's neighbors.

Fluctuations in Currency Exchange Rates and Interest Rates

Our reporting currency is euros but a majority of our revenue and expenses are currently earned or incurred in other currencies. In Israel, which accounted for approximately 68.5% and 47% of the total revenue of the Group in the year ended December 31, 2013 and for the nine months ended September 30, 2014, respectively, on a pro forma basis, a substantial portion of our revenue is in NIS while a portion of our operational expenses and capital expenditures are incurred in other currencies, including the U.S. dollar. In the year ended December 31, 2013 and nine months ended September 30, 2014, respectively, approximately 9% and 12% of our total operating expenses in Israel and approximately 47% and 35% of our total capital expenditures in Israel were incurred in currencies other than NIS. In the Dominican Republic, which accounted for approximately 22.1% of total revenue of the Group in the nine months ended September 30, 2014, on a pro forma basis, a substantial portion of our revenue is in Dominican pesos and 37% of our operating expenses and 52% of our capital expenditure were incurred in U.S. dollars. Our borrowings are denominated in NIS, euros and U.S. dollars but do not necessarily correspond to the portion of revenue we earn in such currencies. The exchange rate between U.S. dollars and NIS, the euro and NIS and U.S. dollars and Dominican pesos has been volatile in the past and may continue to be so in the future. Although we attempt to mitigate currency risk through hedging, sharp changes in the exchange rate could have a material effect on our results of operations. We are also exposed to translation foreign currency exchange risk arising from the consolidation of the financial results of HOT into Altice International's consolidated financial statements and with effect from March 12, 2014 and April 9, 2014, respectively, the consolidation of our operations in the Dominican Republic into Altice International's consolidated financials statements. In the year ended December 31, 2013, compared to 2012, foreign exchange translation movements between the NIS and the euro had a positive impact of €32.6 million on our total revenues and €11.8 million on our EBITDA and in the nine months ended September 30, 2014 compared to the corresponding period in 2013, foreign exchange translation movements between NIS and the euro had a positive impact of €8.3 million on our total revenues and €4.0 million on our total

EBITDA. In the nine months ended September 30, 2014, foreign exchange translation movements between Dominican pesos and the euro had a negative impact of €26.4 million on our total revenues and €12.1 million on our total EBITDA. Further, as adjusted to give effect to the New Transactions, as of September 30, 2014, we had approximately €1,324 million of outstanding indebtedness, which bears interest at a floating rate and is therefore subject to interest rate risk. In addition, any indebtedness that we incur under the Existing Revolving Credit Facilities, the New Revolving Credit Facilities and the 2013 Guarantee Facility will bear interest at a floating rate.

Key Operating Measures

We use several key operating measures, including number of homes passed, Cable Customer Relationships, RGUs, RGUs per Cable Customer Relationship and ARPUs to track the financial and operating performance of our business. None of these terms are measures of financial performance under IFRS, nor have these measures been audited or reviewed by an auditor, consultant or expert. All of these measures are derived from our internal operating and financial systems. As defined by our management, these terms may not be directly comparable to similar terms used by competitors or other companies.

	As of and for the nine months ended September 30, 2014 in thousands except percentages and as otherwise indicated					
	Israel ⁽⁶⁾	Belgium and Luxembourg	Portugal	French Overseas Territories ⁽⁷⁾	Dominican Republic ⁽¹⁰⁾	Total ⁽⁸⁾
CABLE-BASED SERVICES						
Market and Network						
Homes Passed.....	2,329	233	910	178	—	3,650
Docsis 3.0						
Upgraded (%)	100%	100%	99%	95%	—	99.5%
Unique Customers						
Cable Customer Relationships ⁽¹⁾	1,088	110	225	44	—	1,467
Triple-Play Cable Customer Relationships	484	50	133	26	—	693
RGUs & Penetration⁽²⁾⁽³⁾						
Total RGUs.....	2,270	231	578	95	—	3,174
Pay Television RGUs	862	120	214	44	—	1,243
Pay Television Penetration (%).....	37%	52%	24%	25%	—	34%
Broadband internet RGUs	727	59	152	26	—	964
Broadband internet Penetration (%).....	31%	25%	17%	15%	—	26%
Fixed-Line Telephony RGUs..	681	52	213	26	—	972
Fixed-Line Telephony Penetration (%).....	29%	22%	23%	14%	—	27%
RGUs Per Cable Customer Relationship.....	2.1x	2.1x	2.6x	2.2x	—	2.2x
ARPU⁽⁴⁾						
Cable ARPU (€)	48.8	43.6	33.4	55.6	—	—
MOBILE-BASED SERVICES						
Market and Network						
UMTS Mobile Coverage of Territory (%).....	56.30%	—	—	90% ⁽⁹⁾	77%	—
Subscribers						

Total Mobile						
Subscribers ⁽⁵⁾	932	3	—	365 ⁽¹⁴⁾	3,158 ⁽¹¹⁾⁽¹²⁾	4458
Post-paid	927	3	—	205 ⁽¹⁴⁾	685 ⁽¹¹⁾⁽¹²⁾	1820
Prepaid	5	—	—	160 ⁽¹⁴⁾	2,473 ⁽¹¹⁾⁽¹³⁾	2638
ARPU⁽⁴⁾						
Mobile ARPU (€)	15.0	32.2	—	28.4	9.21	—
xDSL/NON-CABLE BASED SERVICES						
RGUs						
Total RGUs.....	—	—	—	152	—	152
Broadband internet						
RGUs	—	—	—	54	—	54
Fixed Line						
Telephony RGUs..	—	—	—	90	—	90

As of and for the nine months ended September 30, 2013
in thousands except percentages and
as otherwise indicated

	Israel ⁽⁶⁾	Belgium and Luxembourg	Portugal	French Overseas Territories ⁽⁷⁾	Dominican Republic ⁽¹⁰⁾	Total ⁽⁸⁾
CABLE-BASED SERVICES						
Market and Network						
Homes Passed.....	2,272	233	906	154	—	3,565
Docsis 3.0						
Upgraded (%)	100%	100%	99%	49%	—	98%
Unique Customers						
Cable Customer						
Relationships ⁽¹⁾	1,145	115	240	38	—	1,538
Triple-Play Cable						
Customer						
Relationships	448	51	136	15	—	650
RGUs & Penetration⁽²⁾⁽³⁾						
Total RGUs.....	2,316	239	609	69	—	3,233
Pay Television RGUs						
.....	881	130	227	38	—	1,276
Pay Television						
Penetration (%).....	39%	56%	25%	25%	—	36%
Broadband internet						
RGUs	755	56	156	15	—	982
Broadband internet						
Penetration (%).....	33%	24%	17%	10%	—	28%
Fixed-Line						
Telephony RGUs..	680	53	226	15	—	974
Fixed-Line						
Telephony						
Penetration (%).....	30%	23%	25%	10%	—	27%
RGUs Per Cable						
Customer						
Relationship	2.0x	2.1x	2.5x	1.8x	—	2.1x
ARPU⁽⁴⁾						
Cable ARPU (€)	47.6	41.1	35.1	50.8	—	—
MOBILE-BASED SERVICES						
Market and Network						
UMTS Mobile						
Coverage of						
Territory (%).....	50%	—	—	89% ⁽⁹⁾	72%	—
Subscribers						

Total Mobile						
Subscribers ⁽⁵⁾	773	3	—	367 ⁽¹⁴⁾	3,178 ⁽¹¹⁾	4,132
Post-paid	762	3	—	188 ⁽¹⁴⁾	591 ⁽¹²⁾	1,356
Prepaid	11	—	—	179 ⁽¹⁴⁾	2,587 ⁽¹¹⁾⁽¹³⁾	2,777
ARPU⁽⁴⁾						
Mobile ARPU (€)	16.9	40.9	—	26.8	9.8	—
xDSL/NON-CABLE						
BASED						
SERVICES						
RGUs						
Total RGUs.....	—	—	—	135	—	135
Broadband internet						
RGUs	—	—	—	55	—	55
Fixed Line						
Telephony RGUs..	—	—	—	80	—	80

As of and for the year ended December 31, 2013
in thousands except percentages and
as otherwise indicated

	Israel ⁽⁶⁾	Belgium and Luxembourg	Portugal	French Overseas Territories ⁽⁷⁾	Total ⁽⁸⁾
CABLE-BASED SERVICES					
Market and Network					
Homes Passed	2,282	233	908	154	3,577
Docsis 3.0 Upgraded (%)	100%	100%	99%	53%	98%
Unique Customers					
Cable Customer Relationships ⁽¹⁾	1,127	114	237	40	1,518
Triple-Play Cable Customer					
Relationships	452	50	135	17	654
RGUs & Penetration⁽²⁾⁽³⁾					
Total RGUs	2,295	239	603	74	3,211
Pay Television RGUs	875	129	224	40	1,268
Pay Television Penetration (%).....	38%	55%	25%	26%	40%
Broadband internet RGUs	744	57	156	17	974
Broadband internet Penetration (%).....	33%	25%	17%	11%	30%
Fixed-Line Telephony RGUs.....	676	53	223	17	969
Fixed-Line Telephony Penetration (%) ...	30%	23%	25%	11%	30%
RGUs Per Cable Customer Relationship.	2.0x	2.1x	2.54	1.86x	2.1x
ARPU⁽⁴⁾					
Cable ARPU (€)	47.6	41.9	34.6	51.4	—
MOBILE-BASED SERVICES					
Market and Network					
UMTS Mobile Coverage of					
Territory (%).....	61%	—	—	89% ⁽⁹⁾	—
Subscribers					
Total Mobile Subscribers ⁽⁵⁾	810	3	—	375 ⁽¹⁴⁾	1,188
Post-paid	801	3	—	197 ⁽¹⁴⁾	1,001
Prepaid	9	—	—	178 ⁽¹⁴⁾	187
ARPU⁽⁴⁾					
Mobile ARPU (€)	16.8	36.8	—	27.1	—
xDSL/NON-CABLE BASED					
SERVICES					
RGUs	—	—	—	—	—
Total RGUs.....	—	—	—	133	133
Broadband internet RGUs	—	—	—	56	56
Fixed Line Telephony RGUs	—	—	—	78	78

As of and for the year ended December 31, 2012 in thousands except percentages and as otherwise indicated

	Israel ⁽⁶⁾	Belgium and Luxembourg	Portugal	French Overseas Territories ⁽⁷⁾	Total ⁽⁸⁾
CABLE-BASED SERVICES					
Market and Network					
Homes Passed.....	2,243	233	906	154	3,536
Docsis 3.0 Upgraded (%).....	100%	100%	94%	37%	95%
Unique Customers					
Cable Customer Relationships ⁽¹⁾	1,198	120	255	39	1,612
Triple-Play Cable Customer Relationships.....	413	50	147	12	626
RGUs & Penetration⁽²⁾⁽³⁾					
Total RGUs.....	2,343	244	648	63	3,298
Pay Television RGUs.....	896	136	245	39	1,316
Pay Television Penetration (%).....	40%	58%	27%	25%	37%
Broadband internet RGUs.....	771	55	159	12	997
Broadband internet Penetration (%).....	34%	24%	18%	8%	28%
Fixed-Line Telephony RGUs.....	676	53	243	12	984
Fixed-Line Telephony Penetration (%) ...	30%	23%	27%	8%	28%
RGUs Per Cable Customer Relationship.	2.0x	2.0x	2.5x	1.6x	2.0x
ARPU⁽⁴⁾					
Cable ARPU (€).....	44.4	39.5	34.9	48.3	—
MOBILE-BASED SERVICES					
Market and Network					
UMTS Mobile Coverage of Territory (%).....	41%	—	—	89% ⁽⁹⁾	—
Subscribers					
Total Mobile Subscribers ⁽⁵⁾	766	2	—	385 ⁽¹⁴⁾	1,153
Post-paid.....	738	2	—	183 ⁽¹⁴⁾	923
Prepaid.....	28	—	—	203 ⁽¹⁴⁾	231
ARPU⁽⁴⁾					
Mobile ARPU (€).....	19.4	14.7	—	26.7	—
xDSL/NON-CABLE BASED SERVICES					
RGUs					
Total RGUs.....	—	—	—	140	140
Broadband internet RGUs.....	—	—	—	57	57
Fixe-Line Telephony RGUs.....	—	—	—	83	83

As of and for the year ended December 31, 2011
in thousands except percentages and
as otherwise indicated

	Israel ⁽⁶⁾	Belgium and Luxembourg	Portugal	French Overseas Territories ⁽⁷⁾	Total ⁽⁸⁾
CABLE-BASED SERVICES					
Market and Network					
Homes Passed.....	2,204	213	906	154	3,477
Docsis 3.0 Upgraded (%).....	100%	100%	85%	17%	92%
Unique Customers					
Cable Customer Relationships ⁽¹⁾	1,245	117	264	41	1,667
Triple-Play Cable Customer Relationships.....	348	49	154	9	560
RGUs & Penetration⁽²⁾⁽³⁾					
Total RGUs.....	2,294	241	669	59	3,263
Pay Television RGUs.....	891	135	256	41	1,323
Pay Television Penetration (%).....	40%	63%	28%	27%	38%
Broadband internet RGUs.....	768	54	162	9	993
Broadband internet Penetration (%).....	35%	25%	18%	6%	29%
Fixed-Line Telephony RGUs.....	635	52	251	9	947
Fixed-Line Telephony Penetration (%) ...	29%	24%	28%	6%	27%
RGUs Per Cable Customer Relationship.	1.8x	2.1x	2.5x	1.4x	2.0x
ARPU⁽⁴⁾					
Cable ARPU (€).....	42.4	36.7	36.9	43.1	—
MOBILE-BASED SERVICES					
Market and Network					
UMTS Mobile Coverage of Territory (%).....	—	—	—	88% ⁽⁹⁾	—
Subscribers					
Total Mobile Subscribers ⁽⁵⁾	444	—	—	355 ⁽¹⁴⁾	799
Post-paid.....	389	—	—	158 ⁽¹⁴⁾	547
Prepaid.....	55	—	—	197 ⁽¹⁴⁾	252
ARPU⁽⁴⁾					
Mobile ARPU (€).....	25.5	—	—	28.9	—
xDSL/NON-CABLE BASED SERVICES					
RGUs					
Total RGUs.....	—	—	—	147	147
Broadband internet RGUs.....	—	—	—	58	58
Fixe-Line Telephony RGUs.....	—	—	—	89	89

(1) Cable Customer Relationships represents the number of individual end users who have subscribed for one or more of our cable based services (including pay television, broadband internet or fixed-line telephony), without regard to how many services to which the end user subscribed. It is calculated on a unique premises basis. Cable Customer Relationships does not include subscribers to either our mobile or ISP services.

(2) RGUs relate to sources of revenue, which may not always be the same as customer relationships. For example, one person may subscribe for two different services, thereby accounting for only one subscriber, but two RGUs. RGUs for pay television and broadband internet are counted on a per service basis and RGUs for fixed-line telephony are counted on a per line basis.

(3) Penetration rates for our pay television, broadband internet and fixed-line telephony services are presented as a percentage of homes passed.

(4) ARPU is an average monthly measure that we use to evaluate how effectively we are realizing revenue from subscribers. ARPU is calculated by dividing the revenue for the service provided after certain deductions for non-customer related revenue (such as hosting fees paid by channels) for the respective period by the average number of customer relationships for that period and further by the number of months in the period. The average number of customer relationships is calculated as the number of customer relationships on the first day in the respective period plus the number of customer relationships on the last day of the respective period, divided by two. For Israel, ARPU has been calculated by using the following exchange rates: (i) average rate for the year ended December 31, 2011 €0.2009 = NIS 1.00, (ii) average rate for the year ended December 31, 2012 €0.2018 = NIS 1.00, (iii) average rate for the year ended December 31, 2013, €0.2092 = NIS 1.00, (iv) average rate for the nine months ended September 30, 2013, €0.2086 = NIS 1.00 and (v) average rate for the nine months ended September 30, 2014, €0.2113 = NIS 1.00. For ODO, ARPU has been calculated by using the following exchange rates: (i) average rate for the nine months ended September 30, 2013 €0.0186 = DOP 1.00 and (ii) average rate for the nine months ended September 30, 2014 €0.017210 = DOP 1.00.

(5) Mobile subscribers is equal to the net number of lines or SIM cards that have been activated on our mobile network. In Israel, the total number of mobile subscribers for our iDEN and UMTS services were as follows:

	As of December 31,			As of September 30,	
	2011	2012	2013	2013	2014
	(in thousands)				
Mobile Subscribers					
iDEN.....	444	325	218	234	186
UMTS.....	—	441	592	539	742
Total.....	444	766	810	773	932

- (6) In Israel, Homes Passed is the number of total Israeli Homes. Our cable network passes a vast majority of Israel's 2.3 million households.
- (7) Only relates to the cable based services (pay television, broadband internet and fixed-line telephony) we provide in Guadeloupe and Martinique and excludes the xDSL based broadband internet (including IPTV) and fixed-line telephony services we provide in Guadeloupe, Martinique, French Guiana, La Réunion and Mayotte following our acquisition of a controlling interest in Outremer in July 2013.
- (8) Total represents the aggregate of the respective key operating measures across all the regions in which we currently operate even though we may not have owned or controlled such business for the entire duration of the periods presented. Israel represents operating measures of HOT (in which we acquired a controlling interest in March 2011) and HOT Mobile; Belgium and Luxembourg represents operating measures of Coditel Belgium and Coditel Luxembourg (in which we acquired a controlling interest from the Numericable Group in June 2011); Portugal represents operating measures of Cabovisão (in which we acquired a controlling interest in February 2012) but not ONI; French Overseas Territories represents operating measures of Le Cable and in respect of mobile services only, Outremer (in which we acquired a controlling interest in July 2013); and Dominican Republic represents operating measures of ODO (in which we acquired a controlling interest in April 2014) but not Tricom.
- (9) Excludes French Guiana.
- (10) Excludes Tricom.
- (11) Includes subscribers through resellers as ODO enters into direct contractual arrangements with customers of resellers. All post-paid subscribers are considered as active. Also includes exclusively mobile subscribers, with mobile broadband/internet subscribers excluded.
- (12) Includes both post-paid residential subscribers and post-paid business subscribers.
- (13) Prepaid residential subscribers only.
- (14) In connection with the acquisition of SFR by Numericable-SFR S.A. (which is controlled by our parent Altice S.A., and therefore an affiliate of the Group), we have entered into a commitment with the French Competition Authority to dispose of our mobile network assets in Mayotte and La Réunion (which are part of our Group's business in the French Overseas Territories) by mid-2015.

Key Income Statement Items

In 2014, in the context of the anticipated acquisition and integration of the French mobile operator Société Française du Radiotéléphone S.A. ("SFR") into the Altice S.A. Group, the board of directors of Altice S.A. decided to amend the presentation of its operational segments, by regrouping the cable-based services segment and B2B segment into a single line called 'Fixed', and by maintaining the mobile segment. Other activities such as content, datacenters and holding company operations are classified under "Others". With effect from January 1, 2014, the Group now follows the same segmentation as Altice S.A. for financial reporting purposes. See Note 8 to the historical consolidated financial statement of Altice International as of and for the nine months ended September 30, 2014. However, for comparative purposes, we have continued to present the discussion and analysis of the results of operations of Altice International for all periods in line with the historical segmentation of the business, i.e., cable-based services, mobile services and B2B and others.

Revenue

Revenue consists of income generated from the delivery of cable-based services, mobile services and B2B and other services to our residential and business subscribers. Revenue is recognized at the fair value of the consideration received or receivable net of value-added tax, returns, rebates and discounts and after eliminating intercompany sales within the Group. We have presented revenue generated from the following services:

Cable-based services: Revenue from cable-based services consists of revenue from pay television services, including related services such as VoD, broadband internet services, fixed-line telephony services and ISP services to our customers. This primarily includes (i) recurring subscription revenue for pay television services, broadband internet and fixed-line telephony (which are recognized in revenue on a straight-line basis over the subscription period), (ii) variable usage fees from Video On Demand (“VoD”) and fixed-line telephony calls (which are recognized in revenue when the service is rendered), (iii) installation fees (which are recognized in revenue when the service is rendered if consideration received is lower than the direct costs to acquire the contractual relationship) and (iv) interconnection revenue received for calls that terminate on our cable network.

Mobile services: Revenue from mobile telephony services primarily consists of (i) recurring subscription revenue for our post-paid mobile services (which are recognized in revenue on a straight-line basis over the subscription period), (ii) revenue from purchases of our pre-paid mobile services (which are recognized in revenue when the service is rendered), (iii) variable usage fees for mobile telephony calls (which are recognized in revenue when the service is rendered), (iv) revenue from the sale of handsets (which are recognized on the date of transfer of ownership), and (v) interconnection revenue received for calls that terminate on our mobile network.

B2B and others: Revenue from the B2B and others segment includes broadband internet access, telephony, virtual private network, leased lines, data center services and other corporate fixed-line services to large and small businesses or government agencies. However, it does not include revenue from standard pay television, broadband internet, fixed-line telephony and mobile services to businesses, which are included under cable or mobile revenue as the case may be. In addition, it also includes revenue from other businesses units such as content delivery and production, provided either directly to customers or to other cable network operators. These primarily include revenue from our B2B business in Portugal, certain pure B2B services in Belgium and Luxembourg, our datacenter and B2B businesses in Switzerland and our content business.

Purchasing and subcontracting services

Purchasing and subcontracting services consists of direct costs associated with the delivery of cable-based services, mobile services and B2B and other services to our residential and business subscribers. We present purchasing and subcontracting services paid for the procurement of the following services:

Cable-based services: Purchasing and subcontracting services associated with cable based services consists of all direct costs related to the (i) procurement of non-exclusive television content, royalties and licenses to broadcast, (ii) transmission of data services, (iii) interconnect costs related to fixed-line telephony. In addition, it includes costs incurred in providing VoD or other interactive services to subscribers and accounting variations arising from changes in inventories of customer premises equipment (such as modems, set top boxes and decoders). In Israel, costs relating to the procurement of exclusive television content from third party providers were included in purchasing and subcontracting services for cable based services until March 31, 2013, but these costs have been capitalized thereafter.

Mobile services: Purchasing and subcontracting services associated with mobile services consists primarily of mobile interconnect fees, including roaming charges and accounting variations arising from the changes in inventories of mobile handsets.

B2B and others: Purchasing and subcontracting services associated with B2B and other services consist of, (i) cost of renting space for datacenters (subject to certain exceptions), (ii) utility costs related to the operation of datacenters (such as power and water supply costs), (iii) hosting and interconnect fees for telephony and broadband internet services to corporate clients or small businesses, and (iv) costs of professional services. In addition, it includes in relation to the content activity of the Group, technical costs associated with the delivery of content, such as satellite rental costs.

Other operating expenses

Other operating expenses consist mainly of the following subcategories:

Customer service costs: Customer service costs include all costs related to billing systems, bank commissions, external costs associated with operating call centers, allowances for bad customer debts and recovery costs associated therewith.

Technical and maintenance: Technical and maintenance costs include all costs related to infrastructure rental, equipment, equipment repair, costs of external subcontractors, maintenance of backbone equipment and datacenter equipment, maintenance and upkeep of the cable and mobile networks, costs of utilities to run network equipment and those costs related to customer installations that are not capitalized (such as service visits, disconnection and reconnection costs).

Staff expenses: For the Historical Financial Information “Other operating expenses” also includes staff expenses, comprised of all costs related to wages and salaries, bonuses, social security, pension contribution and other outlays paid to Group employees involved in technical operations and customer services functions (except for Outremer, which historically has accounted for all salary expenses under this item). Prior to the year ended December 31, 2013, staff costs and employee benefits were recorded under the line items “Other operating expenses”, “General and administrative expenses” and “Other sales and marketing expenses”, depending on the costs which they related to. Beginning with the year ended December 31, 2013, such staff costs and employee benefits have been accounted for in a separate line item and reflect total staff costs for all functions. See the historical financial statements for the nine months ended September 30, 2014 and for the year ended December 31, 2013 elsewhere in these Listing Particulars for further details. For comparative purposes staff and employee costs have been reclassified for the nine months ended September 30, 2013 and for the year ended December 31, 2012, respectively, to match the new reporting method of the Group. For the Pre-PT Transaction Pro Forma Financial Information and the Pre-PT/ODO Transactions Pro Forma Financial Information, staff costs and employee benefits expenses are accounted for under the line items “Other operating expenses”, “General and administrative expenses” and “Other sales and marketing expenses”, depending on the costs which they related to.

Business taxes: Business taxes include all costs related to payroll and professional taxes or fees.

General and administrative expenses

General and administrative expenses consist of office rent and maintenance, professional and legal advice, recruitment and placement, welfare and other administrative expenses. For the purposes of the discussion and analysis of the Pre-PT/ODO Transactions Pro Forma Financial Information, the Pre-PT Transaction Pro Forma Financial Information and their respective comparative periods, it also includes staff costs and employee benefits expenses relating to administrative personnel.

Other sales and marketing expenses

Other sales and marketing expenses consist of salary and associated payments for sales and marketing personnel, advertising and sale promotion, office rent and maintenance, commission’s for marketers, external sales and storage and other expenses related to sales and marketing efforts. For Pre-PT/ODO Transactions Pro Forma Financial Information, the Pre-PT Transaction Pro Forma Financial Information and their respective comparative periods, it also includes staff costs and employee benefits expenses relating to sales and marketing personnel.

Depreciation and amortization

Depreciation and amortization includes depreciation of tangible assets related to production, sales and administrative functions and amortization of intangible assets.

Goodwill impairment

Goodwill impairment includes the write off of any goodwill that has been recognized on the acquisition of new assets based upon a re-evaluation of the cash generating capacity of these assets compared to the initial valuation assigned to the original goodwill of such asset acquisition.

Other expenses, net

Other expenses, net includes any one-off or non-recurring income or expenses incurred during the on-going financial year, excluding restructuring and other non-recurring costs. This includes deal fees paid to external consultants for merger and acquisition activities. With effect from January 1, 2014, other expenses, net have been included in restructuring and other non recurring costs.

Management fees

Management fees include all consulting and management fees paid to related parties. These fees are primarily related to consulting services provided on mergers and acquisitions and negotiations with vendors and banks.

Restructuring and other non-recurring costs

Restructuring and other non-recurring costs include one-off expenses incurred to reorganize existing or newly acquired businesses. Cost incurred are categorized under: (i) operating and maintenance costs when related to equipment redundancies, (ii) rents and other general and administrative expenses when related to building or redundancies of

general installations and (iii) staff expenses, when related to employee redundancies. With effect from January 1, 2014, restructuring and other non-recurring costs include other expenses, net.

Gain arising on step acquisition

Gain arising on step acquisition includes the gain on achieving control in an investment or business and switching from the equity method of accounting to full integration in the consolidated accounts. See note 27 to Altice International's historical consolidated financial statements as of and for the year ended December 31, 2011 included elsewhere in these Listing Particulars.

Share of profit of associates

Share of profit of associates includes revenue arising from activities that are accounted for using the equity method for associates in the consolidation perimeter of the Group.

Finance income

Finance income consists of changes in the net fair value of the financial derivatives, gains from the disposal of financial assets, net exchange rate differences, and other finance income.

Finance costs

Finance costs includes financing expenses for short-term credit facilities, changes in the net fair value of the financial derivatives that do not qualify as hedges for accounting purposes, financing expenses for banking and credit card companies' commissions, financing expenses for long-term loans, financing expenses for bonds, net exchange rate differences and other expenses paid for financing operations recognized at amortized cost.

Income tax expenses

Income tax expenses or income comprise current tax and deferred tax. Taxes on income are recognized in the income statement except when the underlying transaction is recognized in other comprehensive income, at which point the associated tax effect is also recognized under other comprehensive income or in equity.

Discussion and Analysis of Our Results of Operations

Nine Months Ended September 30, 2014 compared to the Nine Months Ended September 30, 2013

Statement of Income Items	Historical Consolidated Financial Information				Pre-PT Transaction Pro Forma Financial Information ⁽²⁾			
	For the nine months ended September 30,		Change		For the nine months ended September 30,		Change	
	2013	2014	Amount	%	2013	2014	Amount	%
	€ in millions except percentages							
Revenue								
Cable based services.....	676.1	721.9	45.8	6.8%	721.1	728.3	7.2	1.0
Mobile services.....	175.9	457.8	281.9	160.3%	579.8	573.4	(6.3)	(1.1)
B2B and others	76.3	193.4	116.8	153.5%	135.2	179.9	44.7	33.1
Total Revenue.....	928.4	1,372.8	444.4	47.9%	1,436.0	1,481.6	45.6	3.2
Purchasing and subcontracting services	(262.2)	(324.5)	(62.3)	23.8%	(429.7)	(351.9)	77.8	(18.1)
Gross Profit	666.2	1,048.3	382.1	57.4%	1,006.3	1,129.7	123.4	12.3
Other operating expenses ⁽¹⁾	(235.7)	(299.7)	(64.0)	27.2%	(251.9)	(256.6)	4.7	(1.9)
General and administrative expenses.....	(24.0)	(36.8)	(12.8)	53.3%	(91.2)	(75.8)	15.4	(16.9)
Other sales and marketing expenses.....	(29.4)	(84.9)	(55.5)	188.8%	(101.9)	(124.9)	(23.0)	22.6
Operating income before depreciation, amortization, restructuring costs and other expenses	377.1	627.0	249.9	66.3%	561.5	672.3	110.8	19.7
Depreciation and amortization ..	(278.0)	(397.6)	(119.6)	43.0%	(352.2)	(412.9)	(60.7)	17.2
Management fees.....	(0.7)	(0.6)	0.1	(14.3)%	(10.2)	(0.6)	9.6	(94.1)

Restructuring and other non-recurring costs ⁽³⁾	(12.3)	(58.5)	(46.2)	375.6%	(24.0)	(61.4)	(37.4)	155.8
Operating profit	86.1	170.3	84.2	97.8%	175.3	197.5	22.3	12.7
Finance income.....	36.2	32.1	(4.1)	(11.3)%	36.9	32.8	(4.1)	(11.1)
Finance costs.....	(184.3)	(334.3)	(150.0)	81.4%	(529.8)	(606.6)	(76.8)	14.5
(Loss)/profit before income tax expenses	(62.0)	(132.0)	(70.0)	112.9%	(317.8)	(376.3)	(58.5)	18.4
Income tax expenses.....	(27.4)	(27.6)	(0.2)	0.7%	(56.8)	(35.8)	21.0	(37.0)
Loss for the period/year	(89.4)	(159.6)	(70.2)	78.5%	(374.6)	(412.1)	(37.5)	10.0

- (1) For the Historical Financial Information “Other operating expenses” also includes staff costs and employee benefits expenses. Prior to the year ended December 31, 2013, staff costs and employee benefits were recorded under the line items “Other operating expenses”, “General and administrative expenses” and “Other sales and marketing expenses”, depending on the costs which they related to. Beginning with the year ended December 31, 2013, such staff costs and employee benefits have been accounted for in a separate line item and reflect total staff costs for all functions. See the historical financial statements for the nine months ended September 30, 2014 elsewhere in these Listing Particulars for further details. For comparative purposes staff and employee costs have been reclassified for the nine months ended September 30, 2013 to match the new reporting method of the Group. For the Pre-PT Transaction Pro Forma Financial Information, staff costs and employee benefits expenses are accounted for under the line items “Other operating expenses”, “General and administrative expenses” and “Other sales and marketing expenses”, depending on the costs which they relate to.
- (2) Pre-PT Transaction Pro Forma Financial Information for the nine months ended September 30, 2013 and 2014, respectively, gives pro forma effect to the acquisition of ODO, but does not give pro forma effect to the acquisition of PT Portugal, Tricom and Mobius nor the disposal of our mobile network assets in Mayotte and La Réunion which we have committed to undertake. Since the financial information for Tricom and Mobius have been consolidated into the Historical Consolidated Financial Information of the Group from January 1, 2014 and March 12, 2014, respectively, following the consummation of the Mobius Acquisition on January 1, 2014 and the Tricom Acquisition on March 12, 2014, the Pre-PT Transactions Pro Forma Financial Information for the nine months ended September 30, 2014 includes the contribution of Tricom and Mobius from the periods for which each of these entities have been consolidated.
- (3) With effect from January 1, 2014, “Other expenses, net” have been included in the “Restructuring and other non recurring costs” line item.

Significant Events Affecting Historical Results

Our results of operations for the nine months ended September 30, 2014 and September 30, 2013 were significantly impacted by the following events:

- In the third quarter of 2013, Altice International acquired a controlling equity interest in Outremer (the financial information of which is consolidated in the Historical Consolidated Financial Information with effect from July 5, 2013). Outremer contributed €51.0 million to revenue, €8.4 million to operating profit and €18.1 million to EBITDA of Altice International on a consolidated basis in the nine months ended September 30, 2013 since July 5, 2013 compared to €145.4 million to revenue, €16.9 million to operating profit and € 54.0 million to EBITDA of Altice International on a consolidated basis for the nine months ended September 30, 2014. For the period from January 1 to July 5, 2013, Outremer had €96.5 million of revenue, € 19.4 million of operating profit and €33.2 million of EBITDA, which are not consolidated in the Historical Consolidated Financial Information of Altice International.
- In the third quarter of 2013, Altice International acquired a 100% equity interest in ONI (through its indirect subsidiary Cabovisão), the financial information of which is consolidated in the Historical Consolidated Financial Information of Altice International with effect from August 8, 2013. ONI contributed €17.4 million to revenue, €1.2 million to operating loss and €2.0 million to EBITDA of Altice International on a consolidated basis in the nine months ended September 30, 2013 since August 8, 2013 and €65.1 million to revenue, €2.4 million to operating loss and €14.4 million to EBITDA of Altice International on a consolidated basis in the nine months ended September 30, 2014. For the period from January 1 until August 8, 2013, ONI had €59.0 million of revenue, €2.8 million of operating loss and €9.2 million of EBITDA, which are not consolidated in the Historical Consolidated Financial Information of the Company.
- In the fourth quarter of 2013, Altice International acquired a controlling interest in Ma Chaîne Sport and SportV, two content producers based in France and Luxembourg respectively, the financial information of which is consolidated in the Historical Consolidated Financial Information of Altice International with effect from October 4, 2013. The two entities contributed €20.1 million to revenue, €2.6 million to operating profit and €10.5 million to the EBITDA of Altice International on a consolidated basis in the nine months ended September 30 2014. These entities did not have an impact on the financial information of Altice International for the nine months ended September 30, 2013.
- In the first quarter of 2014, Altice International acquired a controlling interest in Mobius, the financial information of which is consolidated in the Historical Consolidated Financial Information of Altice International with effect from January 1, 2014. Mobius contributed € 13.2 million to revenue, €1.0 million to operating profit and €3.1 million to EBITDA of Altice International on a consolidated basis in the nine months ended September 30, 2014.

Furthermore, during the first quarter, Altice International also acquired a controlling interest in Tricom, the financial information of which is consolidated in the Historical Consolidated Financial Information of Altice International with effect from March 12, 2014. Tricom contributed € 82.0 million to revenue, €14.1 million to operating profit and €40.5 million to EBITDA of Altice International on a consolidated basis in the nine months ended September 30, 2014. Tricom and Mobius did not have an impact on the consolidated financial information for the nine months ended September 30, 2013.

In the second quarter of 2014, Altice International acquired a controlling interest in ODO, the financial information of which is consolidated in the Historical Consolidated Financial Information of Altice International with effect from April, 1 2014. ODO contributed €218.6 million to revenue, €62.7 million to operating profit and €104.5 million to EBITDA of Altice International on a consolidated basis in the nine months ended September 30, 2014. ODO did not have an impact on the consolidated financial information for the nine months ended September 30, 2013.

Revenue

Historical Consolidated Basis

For the nine months ended September 30, 2014, we generated total revenue of €1,372.8 million, a 47.9% increase compared to €928.4 million for the nine months ended September 30, 2013. Our total revenue by our key regions in the nine months ended September 30, 2014 and 2013, respectively, were: (i) in Israel, €645.9 million and € 669.4 million, (ii) in Belgium and Luxembourg, €54.0 million and €53.2 million, (iii) in Portugal, €140.4 million and €100.9 million (revenue for the nine months ended September 30, 2013 was impacted by the consolidation of ONI only with effect from August 8, 2013 and revenue for the nine months ended September 30, 2014 was impacted by the contribution from ONI for the entire period), (iv) in the French Overseas Territories, €178.7 million and €69.8 million (revenue for the nine months ended September 30, 2013 were impacted by the consolidation of Outremer only with effect from July 5, 2013 and revenue for the nine months ended September 30, 2014 was impacted by the contribution from Outremer and Mobius for the entire duration) and (v) in the Dominican Republic, €300.5 million and nil (the Group did not have any activities in the Dominican Republic prior to March 12, 2014). Foreign exchange translation movements between the NIS and the euro had a positive impact of €8.3 million on total revenue. Foreign exchange translation movements between Dominican pesos and the euro had a negative impact of €26.4 million on total revenue.

Cable based services: For the nine months ended September 30, 2014, we generated cable based services revenue of €721.9 million, a 6.8% increase compared to €676.1 million for the nine months ended September 30, 2013. The increase was primarily due to the inclusion of cable based services revenue from Outremer for the entire duration of the nine months ended September 30, 2014, with cable based services revenue increasing to €68.1 million for the French Overseas Territories for the nine months ended September 30, 2014 compared to €18.7 million for the nine months ended September 30, 2013, offset by a decline in cable based services revenue in Israel and Portugal from €527.0 million and €83.4 million in the nine months ended September 30, 2013, respectively, to €513.0 million and €75.3 million in the nine months ended September 30, 2014, respectively. Foreign exchange translation movements between the NIS and the euro had a positive impact of €6.6 million on cable based service revenue.

Mobile services: For the nine months ended September 30, 2014, we generated mobile services revenue of €457.7 million, a 160.2% increase compared to €175.9 million for the nine months ended September 30, 2013. This was primarily due to the inclusion of € 218.6 million in mobile services revenue generated by ODO for the nine months ended September 30, 2014 (with effect from April 9, 2014). Foreign exchange translation movements between the NIS and the euro had a positive impact of €1.7 million on mobile revenues. Foreign exchange translation movements between Dominican pesos and the euro had a negative impact of €24.6 million on total revenue.

B2B and others: For the nine months ended September 30, 2014, we generated B2B and other services revenue of €193.1 million, a 153.5% increase compared to €76.3 million for the nine months ended September 30, 2013, predominantly due to the inclusion of B2B and others revenue from ONI (€65.1 million for the nine months ended September 30, 2014, compared to €17.5 million for the nine months ended September 30, 2013, and the inclusion of the B2B and others revenue of Tricom (with effect from March 12, 2014) (€54.4 million for the nine months ended September 30, 2014, compared to nil for the nine months ended September 30, 2013).

Pro Forma Consolidated Basis

The following table sets forth our revenue by country of operation and on a pro forma consolidated basis based on the Pre-PT Transaction Pro Forma

	Pre-PT Transaction Pro Forma Financial Information⁽⁵⁾										
	For the nine months ended September 30,										
	2013						2014				
	Israel	Belgium & Luxembourg	Portugal	French Overseas Territories⁽²⁾	Dominican Republic⁽⁴⁾	Others⁽¹⁾	Total	Israel	Belgium & Luxembourg	Portugal	French Overseas Territories
	€ in millions										
Revenue											
Cable based services....	527.0	45.7	83.4	63.7	—	1.3	721.1	513.1	45.9	75.3	—
Mobile Services	142.4	0.8	—	102.6	333.6	—	579.8	132.8	1.0	—	—
B2B and others	—	6.7	76.4	—	—	52.1	135.3	—	7.1	65.1	—
Total Revenue	669.4	53.1	159.9	166.3	333.6	53.4	1,436.3	645.9	54.0	140.4	—

(1) Others include our B2B telecommunications solutions business and datacenter operations in Switzerland (Green and Green Datacenter), our datacenter operations in France and distribution businesses in France and Luxembourg (Ma Chaîne Sport and SportV). We disposed of our interests in Valvision (which was included in Others) in 2014 and Auberimmo are designated as unrestricted subsidiaries under the terms governing the indebtedness of the Group. For the nine months ended September 30, 2014, it contributed €13.2 million of revenue in B2B and other. Mobius has no other revenue streams. Total revenue for the nine months ended September 30, 2014 also includes the contribution of Mobius since its consolidation into the Group from January 1, 2014. For the nine months ended September 30, 2014, Tricom generated total revenue of €82.0 million, cable based service revenue of €19.6 million, mobile services revenue of €54.4 million. Mobius and Tricom did not have any impact on the Pre-PT Transaction Pro Forma Financial Information for the nine months ended September 30, 2013.

(2) For the French Overseas Territories, cable based services includes purchasing and subcontracting services for cable based services we provide in Guadeloupe and Martinique, internet (including IPTV) and fixed line telephony services we provide in Guadeloupe, Martinique, French Guiana, La Réunion and Mayotte. For the nine months ended September 30, 2014, the contribution of Mobius. See note 3 below for details.

(3) Total revenue for the nine months ended September 30, 2014 includes the contribution of Mobius since its consolidation into the Group from January 1, 2014. For the nine months ended September 30, 2014, Tricom generated total revenue of €82.0 million, cable based service revenue of €19.6 million, mobile services revenue of €54.4 million. Mobius and Tricom did not have any impact on the Pre-PT Transaction Pro Forma Financial Information for the nine months ended September 30, 2013.

(4) Excludes Tricom.

(5) Pre-PT Transaction Pro Forma Financial Information for the nine months ended September 30, 2013 and 2014, respectively, gives pro forma effect to the acquisition of PT Portugal, Tricom and Mobius nor the disposal of our mobile network assets in Mayotte and La Réunion which we have committed to undertake. Since the acquisition of PT Portugal, Tricom and Mobius have been consolidated into the Historical Consolidated Financial Information of the Group from January 1, 2014 and March 12, 2014, respectively, following the completion of the acquisition on January 1, 2014 and the Tricom Acquisition on March, 12, 2014, the Pre-PT Transaction Pro Forma Financial Information for the nine months ended September 30, 2014 excludes the contribution of Mobius from the periods for which each of these entities have been consolidated.

Israel: For the nine months ended September 30, 2014, we generated total revenue in Israel of €645.9 million, a 3.5% decrease compared to €669.4 million for the nine months ended September 30, 2013. As compared to the nine months ended September 30, 2013, for the nine months ended September 30, 2014, our cable based services revenue decreased by 2.6% and our mobile services revenue decreased by 6.7%. Foreign exchange translation movements between the NIS and euro had a positive impact of € 8.3 million on total revenue, €6.6 million on cable services revenue and €1.7 million on mobile services revenue. Accordingly, at a constant exchange rate, our total revenue in Israel decreased by 4.8%, our cable based service revenue decreased by 3.9% and our mobile services revenue decreased by 7.9%.

Cable based services revenue in Israel was negatively impacted by a 46,000 net decrease in our total cable RGUs, comprising a 19,000 net decrease in pay television RGUs and a 28,000 net decrease in broadband internet infrastructure access RGUs. The decrease in our cable RGUs was mainly due to significant disruptions to our customer service in the second and third quarter of 2014. The disruptions were caused by (i) the conflict in Gaza in the third quarter of 2014 which had led to closures of several of our service centers and (ii) certain procedural issues experienced by our third party customer service provider, which are in the process of being addressed by management. The decrease in cable based services revenue was partially offset by an increase in cable based services ARPU of 2.6% (1.3% at a constant exchange rate) from €47.6 for the nine months ended September 30, 2013 to €48.8 for the nine months ended September 30, 2014, primarily as a result of our strategic focus on multiple-play offerings and an increase in the take-up of our higher value higher speed broadband internet services. We also experienced an increase in the number of Cable Customer Relationships subscribing for our triple-play service as a result of our bundling strategy, with the number of triple-play Cable Customer Relationships increasing from 448,000 as of September 30, 2013 to 484,000 as of September 30, 2014 as well as the launch of “FiberBox” and our revised broadband internet with speeds of up to 200MG. The decrease in the interconnection fees for fixed line telephony which were implemented in December 2013, following the change in the regulation from the Ministry of Communication, had an impact on the cable based services revenue with the interconnection rate being set at 0.99 agorot per minute for both peak and off peak time calls.

The decrease in mobile services revenue in Israel was mainly due to the decrease in mobile ARPU by €1.9, or 11.2%, to €15.0 for the nine months ended September 30, 2014 compared to €16.9 for the nine months ended September 30, 2013, caused by subscribers disconnecting from our higher ARPU iDEN mobile network, with iDEN customers decreasing to 186,000 for the nine months ended September 30, 2014 compared to 234,000 for the nine months ended September 30, 2013. On a constant foreign exchange rate mobile ARPU decreased by 14.8%. Mobile services revenue for the nine months ended September 30, 2014 was further negatively impacted by a decrease in handset sales in our iDEN service, primarily during the first half of 2014. The decrease in mobile services revenue was offset by an increase in total mobile RGUs from 773,000 for the nine months ended September 30, 2013 to 932,000 for the nine months ended September 30, 2014, due to the increase in UMTS mobile subscribers to 746,000 for the nine months ended September 30, 2014 compared to 592,000 for the nine months ended September 30, 2013. Although the decline in mobile ARPU was offset by an increase in our lower ARPU UMTS based network subscribers, ARPU from gross adds to our mobile RGUs were generally lower than the ARPU for customers churned. Mobile ARPU was also negatively impacted by highly competitive prices for mobile services, in particular for UMTS based 3G services.

Belgium and Luxembourg: For the nine months ended September 30, 2014, we generated total revenue in Belgium and Luxembourg of €54.0 million, a 1.5% increase compared to €53.2 million for the nine months ended September 30, 2013. As compared to the nine months ended September 30, 2013, for the nine months ended September 30, 2014, our cable based services revenue increased by 0.5% to €45.9 million and our mobile services revenue increased from €0.8 million to € 1.0 million.

The increase in cable based services revenue in Belgium and Luxembourg was primarily due to an increase in cable based ARPU by 6.0% to €43.6 in the nine months ended September 30, 2014 compared to €41.1 for the nine months ended September 30, 2013. The increase in cable based services ARPU was due to price increases of some of our triple-play packages in June 2014 and higher sales of our high-end triple-play packages. Cable based services revenue was also positively impacted by a slight increase in broadband internet RGUs which was due to (i) our ability to offer subscribers higher broadband internet connection speeds and increased bandwidth capacity compared to providers relying on alternative technologies such as xDSL and mobile broadband internet networks, (ii) our attractive pricing of broadband internet services and (iii) an increase in the uptake of our triple-play bundles, which include broadband internet services. These factors were offset by a decline in television RGUs, including a net decrease in digital television RGUs, due to customers churning to different platforms such as digital television providers over DSL and satellite operators, customers terminating their television service or having moved out of Coditel’s network areas. We also experienced a decline in fixed line telephony RGUs due to the general trend of customers switching to mobile telephony services.

The increase in mobile services revenue was due to an increase in the number of subscribers during the nine months ended September 30, 2014 with 9,000 net adds during this period as compared to the nine months ended September 30, 2013, offset by a decrease in ARPU due to an increase in basic mobile services subscribers.

Portugal: In the nine months ended September 30, 2014, we generated total revenue in Portugal of €140.4 million, a 12.1% decrease compared to €158.8 million in the nine months ended September 30, 2013. As compared to the nine months ended September 30, 2013, for the nine months ended September 30, 2014, our revenue in Portugal for our cable based services decreased by 9.7% and our B2B and other services revenue decreased by 14.8%.

The decrease in cable based services revenue in Portugal was primarily driven by a net decrease in total number of cable RGUs by 31,000, comprising of a net decrease of 13,000 pay television RGUs, 13,000 fixed line telephony RGUs and 4,000 broadband internet RGUs. These were the result of the continuous intense competition in the Portuguese cable services market during 2014, with aggressive promotions and pricing policies adopted by competitors and their increased focus on competing multiple play offerings, as well as the adverse economic conditions and austerity measures in Portugal which had a negative effect on consumer confidence pushing them to opt for cheaper packages. Cable based services ARPU decreased slightly by €0.8, or 2.3%, to €34.3 in the nine months ended September 30, 2014 compared to €35.1 in nine months ended September 30, 2013, predominantly due to the impact of aggressive competition in each segment of the cable services market which required us to offer certain discounts and undertake other promotional offers, despite an increase in the prices of our products in January 2014. As a result, the ARPU from gross adds to our RGUs were generally lower than the ARPU for customers churned.

The decrease in B2B and other revenue in Portugal was primarily due to the competitiveness in the market. Furthermore, as we renewed contracts with certain of our major clients (data services) who experienced revenue losses, this affected the revenue we generated under these contracts. A decrease in interconnection revenues, due to activity reduction and lower prices of national fixed termination, also contributed to the decrease in B2B and other revenue.

French Overseas Territories: For the nine months ended September 30, 2014, we generated total revenue in the French Overseas Territories, excluding Mobius, of €165.5 million, a 0.5% decrease compared to €166.3 million for the nine months ended September 30, 2013. As compared to the nine months ended September 30, 2013, for the nine months ended September 30, 2014, our revenue in the French Overseas Territories for our cable based services decreased by 4.0% and our mobile services revenue increased by 1.5%.

The €2.5 million decrease in cable based services revenue in the French Overseas Territories was due to (i) a decrease in fixed line revenue of Outremer, which in turn was mainly as a result of a net decrease of 7,000 fixed line telephony RGUs due to continuation in the trend of customers switching from traditional voice telephony towards multiple play VoIP packages and (ii) a decrease in broadband internet services revenue of Outremer which in turn was mainly as a result of a net decrease of 1,000 xDSL broadband internet RGUs and a 6.5% decrease in ARPU due to increased competition, partly as a result of the launch of “Canal Box” by Canal+. This was partially offset by a 4.4% increase in cable based services ARPU with respect to our cable based services offered by Le Cable in Guadeloupe and Martinique to €55.6 for the nine months ended September 30, 2014 compared to €50.8 for the nine months ended September 30, 2013 and a net increase of 26,000 cable RGUs during this period as a result of our strategic focus on triple-play offerings reflected in an increase in triple-play Cable Customer Relationships by 11,000 to 26,000 as of September 30, 2014 compared to 17,000 as of December 31, 2013.

The €1.6 million increase in mobile services revenue in the French Overseas Territories, all of which is attributable to Outremer, was primarily due to a net increase of 17,000 post-paid mobile subscribers over the period, offset by a decline in prepaid mobile subscribers. This increase was a result of the revamping of Outremer’s mobile post-paid offering that was launched in the first half of 2012, particularly due to the success of flat fee rate plans with unlimited calls within the French Overseas Territories and mainland France. Mobile ARPUs increased by €1.7 primarily due to the improvements in our product mix and an increase in the take-up of Outremer’s higher value post-paid packages following the revamping of its mobile product offering.

Dominican Republic (ODO): For the nine months ended September 30, 2014, we generated total revenue in the Dominican Republic of €327.4 million, a 2.0% decrease compared to €333.6 million for the nine months ended September 30, 2013.

The decrease in revenue in the Dominican Republic was due to the foreign exchange translation movements between Dominican pesos and the euro, which had a negative impact of €29.0 million in the nine months ended September 30, 2014. At a constant exchange rate, our total revenue increased by 6.8% in the nine months ended September 30, 2014, driven by an increase in both our residential and business post-paid subscribers, with a net addition of 94,000 post-paid subscribers during this period, of which 69.6 were residential subscribers and 24.4 were business subscribers. The increase in post-paid residential subscribers was primarily due to the success of our flexible monthly plans, including low monthly rate subscriptions with the ability to add-on additional services such as data through promotional offers. The

increase in post-paid business subscribers was primarily due to the continuous expansion of our enterprise business and a stronger penetration strategy and sales staff dedicated to soliciting more subscribers. This was partially offset by a slight decrease in ODO's mobile ARPU to €9.21 for the nine months ended September 30, 2014 from €9.8 for the nine months ended September 30, 2013, primarily due to the fact that ODO altered its postpaid offerings to tackle competition, resulting in price erosion, and that ODO is encouraging migration from prepaid to postpaid plans and such migrated customers usually opt for basic, cover-cost plans.

Gross Profit

Historical Consolidated Basis

For the nine months ended September 30, 2014, our total gross profit was €1,048.3 million, a 57.4% increase compared to €666.2 million for nine months ended September 30, 2013. Our gross profit by our key regions in the nine months ended September 30, 2013 and 2014 respectively, were: (i) in Israel, €485.0 million and € 517.2 million, (ii) in Belgium and Luxembourg, €44.0 million and €45.2 million, (iii) in Portugal, €64.5 million and €80.2 million (gross profit for the nine months ended September 30, 2013 was impacted by the consolidation of ONI only with effect from August 8, 2013 and for the nine months ended September 30, 2014 was impacted by the consolidation of ONI for the entire duration), (iv) in the French Overseas Territories, €50.8 million and €136.0 million (gross profit for the nine months ended September 30, 2013 was impacted by the consolidation of Outremer only with effect from July 5, 2013 and for the nine months ended September 30, 2014 was impacted by the consolidation of Outremer and Mobius for the entire duration) and (v) in the Dominican Republic, nil and €234.1 million (the Group did not have any activities in the Dominican Republic prior to March 12, 2014). Our gross margin increased from 71.8% in the nine months ended September 30, 2013 to 76.4% in the nine months ended September 30, 2014. Foreign exchange translation movements between the NIS and the euro had a positive impact of € 6.7 million on total gross profit. Foreign exchange translation movements between Dominican pesos and the euro had a negative impact of € 12.7 million on total gross profit.

Cable based services: For the nine months ended September 30, 2014, our gross profit from our cable based services was €578.1 million, a 7.4% increase compared to €538.3 million for the nine months ended September 30, 2013. The increase was primarily due to the inclusion of cable based services gross profit from Outremer for the entire duration of nine months ended September 30, 2014 of €108.7 million compared to €34.6 million for the nine months ended September 30, 2013, following the consolidation of Outremer on July 5, 2013. Our gross margin for cable based services increased to 80.1% in the nine months ended September 30, 2014 from 79.6% in the nine months ended September 30, 2013. Foreign exchange translation movements between the NIS and the euro had a positive impact of €5.5 million on gross profit for our cable based services.

Mobile services: For the nine months ended September 30, 2014, our gross profit from our mobile services increased to €339.1 million compared to €82.1 million in the previous year. The increase was predominantly due to the inclusion of mobile based services gross profit from ODO of €171.6 million for the nine months ended September 30, 2014, following the consolidation of ODO on April 9, 2014. Our gross margin for mobile based services increased to 74.1% in the nine months ended September 30, 2014 from 46.7% in the nine months ended September 30, 2013. Foreign exchange translation movements between the NIS and the euro had a positive impact of €1.2 million.

B2B and others: For the nine months ended September 30, 2014, our gross profit from B2B and others was €131.1 million, a 187.3% increase compared to €45.6 million for the nine months ended September 30, 2013. Our gross margin for B2B and other services decreased from 78.6% in the nine months ended September 30, 2013 to 67.9% in the nine months ended September 30, 2014. The increase in gross profit was primarily due to inclusion of B2B and other services gross profit of ONI of €28.6 million for the entire duration of the nine months ended September 30, 2014 compared to €7.2 million for the nine months ended September 30, 2013, following the consolidation of ONI on August 5, 2013.

Pro Forma Consolidated Basis

The following table sets forth our purchasing and subcontracting services by country of operation and on a Pro Forma Consolidated Basis based on our Pre-PT Transaction Pro Forma Financial Information.

	Pre-PT Transaction Pro Forma Financial Information ⁽⁵⁾										
	For the nine months ended September 30,										
	2013						2014				
	Israel	Belgium & Luxembourg	Portugal	French Overseas Territories ⁽²⁾	Dominican Republic ⁽⁴⁾	Others ⁽¹⁾	Total	Israel	Belgium & Luxembourg	Portugal	French Overseas Territories
	€ in millions										
Purchasing and subcontracting services											
Cable based services.....	101.6	7.2	26.2	17.2	—	0.3	152.5	86.5	7.4	23.3	
Mobile Services.....	82.8	0.7	—	31.6	101.5	—	216.3	42.1	1.2	—	
B2B and others.....	—	1.3	41.5	—	—	18.1	60.8	—	0.3	36.9	
Total purchasing and subcontracting services...	184.4	9.1	67.7	48.8	101.5	18.4	429.6	128.7	8.8	60.2	

- (1) Others include our B2B telecommunications solutions business and datacenter operations in Switzerland (Green and Green Datacenter), our datacenter operations in France and distribution businesses in France and Luxembourg (Ma Chaîne Sport and SportV). We disposed of our interests in Valvision (which was included in Others) in 2014 and Auberimmo are designated as unrestricted subsidiaries under the terms governing the indebtedness of the Group. For the nine months ended September 30, 2014, it contributed €1.3 million from March 12, 2014. See note 3 below for details.
- (2) For the French Overseas Territories, cable based services includes purchasing and subcontracting services for cable based services we provide in Guadeloupe and Martinique, internet (including IPTV) and fixed-line telephony services we provide in Guadeloupe, Martinique, French Guiana, La Réunion and Mayotte. For the nine months ended September 30, 2014, the contribution of Mobius was €17.6 million. See note 3 below for details.
- (3) Total purchasing and subcontracting services costs for the nine months ended September 30, 2014 includes the contribution of Mobius since its consolidation into the Group on September 30, 2014, Mobius generated €4.0 million of purchasing and subcontracting services costs in B2B and other. Mobius has no other revenue streams. Total purchasing and subcontracting services costs for the nine months ended September 30, 2014 also includes the contribution made by Tricom from March 12, 2014. For the nine months ended September 30, 2014, Tricom contributed services costs of €17.6 million, cable based service purchasing and subcontracting services costs of €14.1 million, mobile services purchasing and subcontracting services costs of €1.3 million. Mobius and Tricom did not have an impact in the Pre-PT Transaction Pro Forma Financial Information for the nine months ended September 30, 2014.
- (4) Excludes Tricom.
- (5) Pre-PT Transaction Pro Forma Financial Information for the nine months ended September 30, 2013 and 2014, respectively, gives pro forma effect to the acquisition of PT Portugal, Tricom and Mobius nor the disposal of our mobile network assets in Mayotte and La Réunion which we have committed to undertake. Since these entities have been consolidated into the Historical Consolidated Financial Information of the Group from January 1, 2014 and March 12, 2014, respectively, following the acquisition of PT Portugal on January 1, 2014 and the Tricom Acquisition on March 12, 2014, the Pre-PT Transaction Pro Forma Financial Information for the nine months ended September 30, 2014 excludes Mobius from the periods for which each of these entities have been consolidated.

Israel: For the nine months ended September 30, 2014, our purchasing and subcontracting services costs in Israel were €128.7 million, a 30.2% decrease compared to €184.4 million for the nine months ended September 30, 2013. As compared to the nine months ended September 30, 2013, for the nine months ended September 30, 2014, our purchasing and subcontracting services costs for cable based services decreased by 14.9% and our purchasing and subcontracting services costs for mobile services decreased by 49.2%. Foreign exchange translation movements between NIS and euro had a negative impact of increasing purchasing and subcontracting services costs by €1.6 million (including €1.1 million of cable based services purchasing and subcontracting services costs and €0.5 million of mobile services purchasing and subcontracting services costs). Accordingly, at a constant exchange rate, our total purchasing and subcontracting services costs in Israel decreased by 31.1%, our cable based service purchasing and subcontracting services costs decreased by 15.9% and our purchasing and subcontracting services costs for mobile services decreased by 49.8%.

The decrease in purchasing and subcontracting services costs for cable based services in Israel was due to (i) a decrease in interconnection fees paid as a result of lower fixed-line telephony call volumes by our customers with fixed-line telephony customers switching to mobile services, with the latter providing competitive prices and unlimited price plan packages, (ii) a decrease in the interconnection fees for fixed-line (thereby having a greater impact in the nine months ended September 30, 2014) telephony services which came into effect in December 2013, as a result of changes to the regulation implemented by the Ministry of Communication, (iii) the positive effect of renegotiated movie channel contracts, and (iv) the change in the amortization rate for certain productions since April 1, 2013, allowing us to amortize related costs over a three year period as opposed to the previous one year period, reflecting the fact that consumers make use of the content subscription for more than one year.

The decrease in purchasing and subcontracting services costs for mobile services in Israel was primarily due to a decrease in interconnection fees stemming from the decrease in national roaming costs as a result of the arrangements we have with Partner under the RoU.

Belgium and Luxembourg: For the nine months ended September 30, 2014, our purchasing and subcontracting services costs in Belgium and Luxembourg were €8.8 million, a 3.2% decrease compared to €9.1 million for the nine months ended September 30, 2013. As compared to the nine months ended September 30, 2013, for the nine months ended September 30, 2014 our purchasing and subcontracting services costs for cable based services increased by 0.8% and our purchasing and subcontracting services costs for B2B services decreased by 79.4% (from €1.4 million to €0.3 million). We began providing mobile services in Belgium as a MVNO in September 2012 and incurred purchasing and subcontracting services costs of €0.7 million and €1.2 million for the nine months ended September 30, 2013 and 2014, respectively.

The slight increase in purchasing and subcontracting services costs for cable based services was due to higher programming expenses.

The decrease in purchasing and subcontracting services costs for B2B services was due to (i) the nature of B2B projects undertaken in 2014 (for which costs were primarily in the form of capital expenditures) as compared to the same period in the previous year and (ii) the decrease in promotional offers and incentives during the nine months ended September 30, 2014, as compared to the offers and incentives we offered during the same period in the previous year.

The increase in purchasing and subcontracting services costs for mobile services was due to an increase in subscribers, in particular, subscribers with high usage rates which in turn also resulted in higher fees payable to our MNVO provider.

Portugal: For nine months ended September 30, 2014, our purchasing and subcontracting services costs in Portugal were €60.2 million, a 11.1% decrease compared to €67.7 million for the nine months ended September 30, 2013. As compared to the nine months ended September 30, 2013, for the nine months ended September 30, 2014, our purchasing and subcontracting services costs for each of cable based services decreased by 11.1% and B2B and others based purchasing and subcontracting services costs decreased by 10.9%.

The 11.1% decrease in purchasing and subcontracting services costs for cable based services in Portugal was primarily due to lower sales and the operational optimization program implemented by the Group following the acquisition Cabovisão in February 2012.

The 10.9% decrease in costs of sales for B2B and others in Portugal was due to the lower level of ONI's activity and the reduction in national fixed termination prices. Cost reduction measures such as the renegotiations of supplier contacts and revisions to the costs associated with technical solutions were also undertaken to reduce the impact of re-negotiated pricing terms with some of our larger clients to avoid a negative impact on margins.

French Overseas Territories: For the nine months ended September 30, 2014, our purchasing and subcontracting services costs in the French Overseas Territories, excluding Mobius, were €45.5 million, a 6.7% decrease compared to €48.8 million for the nine months ended September 30, 2013. As compared to the nine months ended September 30, 2013, for the nine months ended September 30, 2014, our purchasing and subcontracting services costs for cable based services decreased by 23.6% and our purchasing and subcontracting services costs for mobile services increased by 2.5%.

The decrease in purchasing and subcontracting services costs for cable based services in the French Overseas Territories was primarily due to the decrease in Outremer's fixed-line telephony and xDSL broadband internet RGUs.

The increase in purchasing and subcontracting services costs for mobile services in the French Overseas Territories was mainly due to the increase in post-paid RGUs and interconnections costs with the success of Outremer's flat-fee rate plans which include unlimited calls.

Dominican Republic (ODO): For the nine months ended September 30, 2014, our purchasing and subcontracting services cost in the Dominican Republic, all of which relates to the mobile services provided by ODO, were €76.2 million, a 24.9% decrease compared to €101.5 million for the nine months ended September 30, 2013.

The €20.3 million decrease in mobile services revenue in the Dominican Republic was due to the foreign exchange translation movements between Dominican pesos and the euro, which had a negative impact of €5.2 million in the nine months ended September 30, 2014. At a constant exchange rate, our purchasing and subcontracting services costs increased by 8.3%, predominantly due to an increase in the activity, offset by the reclassification of certain commercial costs previously recorded as sales and marketing expenses.

As a result of the factors described above, our gross profit and gross margin by country of operation on a pro forma consolidated basis based on the Pre- PT Transaction Pro Forma Financial Information for the nine months ended September 2014 and 2013, respectively:

Pre-PT Transaction Pro Forma Financial Information ⁽⁵⁾														
For the nine months ended September 30,														
2013							2014							
Israel	Belgium & Luxembourg	Portugal	French Overseas Territories ⁽²⁾	Dominican Republic	Others ⁽¹⁾	Total	Israel	Belgium & Luxembourg	Portugal	French Overseas Territories ⁽²⁾	Dominican Republic ⁽⁴⁾	Others ⁽¹⁾	Total ⁽³⁾	
€ in millions														
Gross profit														
Cable based services	425.4	38.5	57.3	46.5	—	1.0	568.7	426.5	38.5	52.0	64.8	—	5.6	587.5
Mobile Services	59.6	0.1	—	71.0	232.5	—	363.5	90.7	(0.1)	—	71.2	251.2	5.7	418.7
B2B and others	—	5.4	34.9	—	—	34.1	74.6	—	6.8	28.2	—	—	41.8	123.5
Total gross profit	485.0	44.1	92.2	117.5	232.5	35.1	1,006.4	517.2	45.2	80.2	136.1	251.2	99.8	1,129.7

Pre-PT Transaction Pro Forma Financial Information ⁽⁵⁾														
For the nine months ended September 30,														
2013							2014							
Israel	Belgium & Luxembourg	Portugal	French Overseas Territories ⁽²⁾	Dominican Republic ⁽⁴⁾	Others ⁽¹⁾	Total	Israel	Belgium & Luxembourg	Portugal	French Overseas Territories ⁽²⁾	Dominican Republic ⁽⁴⁾	Others ⁽¹⁾	Total ⁽³⁾	
€ in millions														
Gross margin														
Cable based services (%)	80.7	84.0	68.6	73.0	—	78.2	78.9	83.1	69.1	87.1	—	28.1	80.6	
Mobile Services (%)	41.9	45.8	—	69.2	69.6	—	62.7	68.3	(13.9)	68.3	76.7	72.5	73.1	
B2B and others (%)	80.7	79.5	45.9	—	—	65.4	55.1	—	96.0	43.3	—	82.3	68.7	
Total gross margin (%)	72.5	82.9	57.8	70.7	69.6	65.7	70.1	80.1	83.7	57.1	76.1	76.7	73.8	76.3

(1) Others include our B2B telecommunications solutions business and datacenter operations in Switzerland (Green and Green Datacenter), our datacenter operations in France (Auberimmo) and our content production and distribution businesses in France and Luxembourg (Ma Chaîne Sport and SportV). We disposed of our interests in Valvision (which was included in Others) in 2013 to the Numericable Group. Green Datacenter and Auberimmo are designated as unrestricted subsidiaries under the terms governing the indebtedness of the Group. For the nine months ended September 30, 2014, it also includes the contribution made by Tricom from March 12, 2014. See note 3 hereto for details.

(2) For the French Overseas Territories, cable based services includes gross profit and gross margin for cable based services we provide in Guadeloupe and Martinique as well as the xDSL based broadband internet (including IPTV) and fixed-line telephony services we provide in Guadeloupe, Martinique, French Guiana, La Réunion and Mayotte. For the nine months ended September 30, 2014, it also includes the contribution for Mobius. See note 3 below for details.

(3) Total gross profit and total gross margin for the nine months ended September 30, 2014, includes the contribution of Mobius since its consolidation into the Group from January 1, 2014. For the nine months ended September 30, 2014, Mobius generated a gross profit of €9.3 million and a gross margin of 70.1% in B2B and other. Mobius has no other revenue streams. Total gross profit for nine months ended September 30, 2014 also includes the contribution made by Tricom from March, 2014. For the nine months ended September 30, 2014,

Tricom generated a gross profit of €64.4 million and a gross margin of 28.0%, cable based service gross profit of €5.5 million and cable based service gross margin of 28.0%, mobile services gross profit of €5.7 million and mobile services gross margin of 72.2% and B2B/Other gross profit of €53.1 million and B2B/Other gross margin of 97.6%.

- (4) Excludes Tricom.
- (5) Pre-PT Transaction Pro Forma Financial Information for the nine months ended September 30, 2013 and 2014, respectively, gives pro forma effect to the acquisition of ODO, but does not give pro forma effect to the acquisition of PT Portugal, Tricom and Mobius nor the disposal of our mobile network assets in Mayotte and La Réunion which we have committed to undertake. Since the financial information for Tricom and Mobius have been consolidated into the Historical Consolidated Financial Information of the Group from January 1, 2014 and March 12, 2014, respectively, following the consummation of the Mobius Acquisition on January 1, 2014 and the Tricom Acquisition on March 12, 2014, the Pre-PT Transaction Pro Forma Financial Information for the nine months ended September 30, 2014 includes the contribution of Tricom and Mobius from the periods for which each of these entities have been consolidated.

Foreign exchange translation movements between the NIS and euro had a positive impact of €6.7 million on total gross profit in Israel, including €5.5 million for cable-based services and €1.2 million for mobile services. Foreign exchange translation movements between the Dominican peso and euro had a negative impact of €19.9 million on total gross profit in the Dominican Republic.

Operating Expenses and EBITDA

Historical Consolidated Basis

For the nine months ended September 30, 2014, our total operating expenses (other than purchasing and subcontracting services costs) were €421.4 million, a 45.8% increase compared to €289.1 million for the nine months ended September 30, 2013. Our total operating expenses comprise of other operating expenses, which increased by 27.2%, general and administrative expenses, which increased by 53.3% and other sales and marketing expenses, which increased by 188.8%, in each case in the nine months ended September 30, 2014, compared to the nine months ended September 30, 2013.

Our total operating expenses by our key regions in the nine months ended September 30, 2013 and 2014, respectively, were: (i) in Israel, €215.1 million and €202.6 million, (ii) in Belgium and Luxembourg, €8.6 million and €8.9 million, (iii) in Portugal, €28.7 million and €35.9 million (operating expenses for the nine months ended September 30, 2013 were impacted by the consolidation of ONI into the Group only with effect from August 8, 2013, and operating expenses for the nine months ended September 30, 2014, were impacted by the consolidation of ONI for the entire duration) (iv) in the French Overseas Territories, €22.3 million and €63.4 million (operating expenses for the nine months ended September 30, 2013, was impacted by the consolidation of Outremer with effect from July 5, 2013 and for the nine months ended September 30, 2014 were impacted by the consolidation of Outremer for the entire duration and (v) in the Dominican Republic, nil and €89.1 million (the Group did not have any operations in the Dominican Republic prior to March 12, 2014).

We define EBITDA in our Historical Consolidated Financial Statements as operating profit before depreciation and amortization, goodwill impairment, other expenses, net, management fees and restructuring and other non-recurring costs.

As a result, for the nine months ended September 30, 2014, our EBITDA increased to €627.0 million a 66.3% increase compared to €377.1 million for the nine months ended September 30, 2013. Our EBITDA by our key regions for the nine months ended September 30, 2013 and 2014, respectively, were: (i) in Israel, €269.9 million and €314.6 million, (ii) in Belgium and Luxembourg, €35.4 million and €36.3 million, (iii) in Portugal, €35.8 million and €44.3 million (EBITDA for the nine months ended September 30, 2013 was impacted by the consolidation of ONI only with effect from August 8, 2013 and EBITDA for the nine months ended September 30, 2014 was impacted by the consolidation of ONI for the entire duration), (iv) in the French Overseas Territories, €28.5 million and €72.7 million due to the fact that EBITDA for the nine months ended September 30, 2013 was impacted by the consolidation of Outremer only with effect from July 5, 2013 and that EBITDA for the nine months ended September 30, 2014 was impacted by the consolidation of Outremer for the entire duration and (v) in the Dominican Republic, nil and €145.0 million (the Group did not have any operations in the Dominican Republic prior to March 12, 2014).

Pro Forma Consolidated Basis

The following paragraphs set forth our total operating expenses by country of operation and on a pro forma consolidated basis based on the Pre-PT Transaction Pro Forma Financial Information.

For the nine months ended September 30, 2014, our total operating expenses were €457.4 million, a 2.8% increase compared to €444.9 million for the nine months ended September 30, 2013.

Israel: For the nine months ended September 30, 2014, our total operating expenses in Israel were €202.6 million, a 5.8% decrease compared to €215.1 million for the nine months ended September 30, 2013. Foreign exchange translation movements between NIS and euro had the impact of increasing operating expenses by €2.6 million. Accordingly, at a constant exchange rate, our total operating expenses in Israel decreased by 7.0%.

Other operating expenses: As compared to the nine months ended September 30, 2013, for the nine months ended September 30, 2014 our other operating expenses in Israel decreased by 9.7% from €157.9 million to €142.5 million. This decrease was primarily due to a decrease in salaries and social benefits and a reduction in head count as part of the measures implemented to maximize cost structure efficiency. In addition, in July 2013, our customer services and technical support functions were outsourced which also contributed to the decrease in salaries and social benefits expenses, partially offset by an increase in costs relating to the outsourcing of customer and technical services. The decrease of other operating expenses was also impacted by a decrease in cable network maintenance and set-top box maintenance expenses due to recent investments leading to the improvement of our network and a more efficient maintenance process for set-top boxes.

General and administrative expenses: As compared to the nine months ended September 30, 2013, for the nine months ended September 30, 2014 our general and administrative expenses in Israel increased by 4.3% from €20.8 million to €21.7 million. This increase was primarily due to an increase in employee costs.

Other sales and marketing expenses: As compared to the nine months ended September 30, 2013, for the nine months ended September 30, 2014, our other sales and marketing expenses in Israel increased by 5.2% from €36.4 million to €38.4 million. Compared to the prior year period, our sales and marketing expenses increased as a result of an increase in advertising costs including advertising costs relating to the campaigns for the launch of our net set-top box “FiberBox” in March 2014 and our high-speed internet “200Mg” in May 2014 as well as an increase in advertising costs for our mobile handsets in June 2014.

EBITDA: As a result of the factors discussed above, for the nine months ended September 30, 2014, in Israel our EBITDA was €314.6 million, a 16.6% increase compared to €269.9 million for the nine months ended September 30, 2013 and our EBITDA margin was 48.7% in the nine months ended September 30, 2014 compared to 40.3% in the nine months ended September 30, 2013. Foreign exchange translation movements between the NIS and euro had a positive impact of €4.1 million on total EBITDA.

Belgium and Luxembourg: For the nine months ended September 30, 2014, our total operating expenses in Belgium and Luxembourg were €8.9 million, an increase of 2.7% compared to €8.6 million for the nine months ended September 30, 2013.

Other operating expenses: As compared to the nine months ended September 30, 2013, for the nine months ended September 30, 2014 our other operating expenses in Belgium and Luxembourg increased from €2.7 million to €4.1 million. This increase was primarily due to an increase in customer service costs relating to higher bad or overdue debt for the nine months ended September 30, 2014, compared to the nine months ended September 30, 2013, and higher technical maintenance staff expenses mainly due to cost of living adjustments.

General and administrative expenses: General and administrative costs decreased from €4.8 million for the nine months ended September 30, 2013 to €2.8 million for the nine months ended September 30, 2014, due to a decrease in costs from external consultants.

Other sales and marketing expenses: As compared to the nine months ended September 30, 2013, for the nine months ended September 30, 2014 our other sales and marketing expenses in Belgium and Luxembourg increased from €1.2 million to €1.9 million. This decrease can be attributed to higher sales and marketing expenses for the nine months ended September 30, 2013, associated with the launch of “LaBox”.

EBITDA: As a result of the factors discussed above, for the nine months ended September 30, 2014, our EBITDA in Belgium and Luxembourg was €36.3 million, a 2.5% increase compared to €35.4 million for the nine months ended September 30, 2013. Our EBITDA margin was 67.2% in the nine months ended September 30, 2014 compared to 66.5% in nine months ended September 30, 2013.

Portugal

In the nine months ended September 30, 2014, our total operating expenses in Portugal were €35.9 million, a 23.9% decrease compared to €47.2 million for the nine months ended September 30, 2013. This decrease was due to a lower level of activities in the nine months ended September 30, 2014 compared to the prior year period and the continued effect of the operational optimization program implemented by the Group following the acquisitions of Cabovisão in February 2012 and ONI in August 2013.

Other operating expenses: For the nine months ended September 30, 2014 our other operating expenses in Portugal decreased by 28.0% to €21.2 million, compared to €29.5 million for the nine months ended September 30, 2013. This decrease mainly reflects strong cost reductions in outsourcing services and personnel and contract renegotiations at ONI after its acquisition by the Group in August 2013.

General and administrative expenses: As compared to the nine months ended September 30, 2013, for the nine months ended September 30, 2014 our general and administrative expenses in Portugal decreased by 31.9% from €10.5 million to €7.2 million. This decrease was primarily due to savings at both Cabovisão and ONI resulting from (i) headcount reductions in corporate and administrative staff and (ii) the cancellation and renegotiation of several contracts for administrative services.

Other sales and marketing expenses: As compared to the nine months ended September 30, 2013, for the nine months ended September 30, 2014 our other sales and marketing expenses in Portugal increased by 4.1% from €7.3 million to €7.6 million.

EBITDA: As a result of the factors discussed, in the nine months ended September 30, 2014, our EBITDA in Portugal was €44.3 million, a decrease of 1.9% compared to €45.1 million in the nine months ended September 30, 2013. Our EBITDA margin was 31.5% in the nine months ended September 30, 2014 compared to 28.2% in the nine months ended September 30, 2013.

French Overseas Territories: For the nine months ended September 30, 2014, our total operating expenses in the French Overseas Territories, excluding Mobius, were €50.4 million, a 9.2% decrease compared to €55.5 million for the nine months ended September 30, 2013.

Other operating expenses: As compared to the nine months ended September 30, 2013, for the nine months ended September 30, 2014 our other operating expenses in the French Overseas Territories, excluding Mobius, remained fairly stable at €32.8 million, compared to €32.2 million for the nine months ended September 30, 2013. The cost savings achieved in IT and network maintenance cost were offset by increased costs related to measures taken to improve quality of service, in particular the densification of mobile networks.

General and administrative expenses: As compared to the nine months ended September 30, 2013, for the nine months ended September 30, 2014 our general and administrative expenses in the French Overseas Territories, excluding Mobius, decreased by 29.9% from €12.1 million to €8.5 million. This decrease was due to measures taken to reduce rental, travel, legal and other expenses as well as a reduction in non-recurring expenses indirectly related to the acquisition of Outremer by Altice International which impacted the general and administrative expenses for the nine months ended September 30, 2013.

Other sales and marketing expenses: As compared to the nine months ended September 30, 2013, for the nine months ended September 30, 2014 our other sales and marketing expenses in the French Overseas Territories decreased, excluding Mobius, by 18.1% from €11.2 million to €9.2 million. This decrease was primarily due to the decrease in the level of retention and acquisition subsidies for mobile subscribers and a lower number of new products and offers being launched in 2014.

EBITDA: As a result of the factors discussed, for the nine months ended September 30, 2014, our EBITDA in the French Overseas Territories, excluding Mobius, was €69.5 million, a 11.9% increase compared to €62.1 million for the nine months ended September 30, 2013. Our EBITDA margin was 42.0% in the nine months ended September 30, 2014 compared to 37.3% in the nine months ended September 30, 2013.

Dominican Republic (ODO): For the nine months ended September 30, 2014, our total operating expenses in the Dominican Republic, excluding Tricom, were €101.3 million, a 0.7% increase compared to €100.7 million for the nine months ended September 30, 2013.

Other operating expenses: As compared to the nine months ended September 30, 2013, for the nine months ended September 30, 2014 our other operating expenses in the Dominican Republic, excluding Tricom, increased by 39.7% from €24.7 million to €34.5 million. This decrease was primarily due to the cost savings we achieved through renegotiated supplier contracts relating to network maintenance, media fees, handsets and call center tariffs.

General and administrative expenses: As compared to the nine months ended September 30, 2013, for the nine months ended September 30, 2014 our general and administrative expenses in the Dominican Republic, excluding Tricom, decreased by 74.8% from €33.7 million to €8.5 million.

Other sales and marketing expenses: As compared to the nine months ended September 30, 2013, for the nine months ended September 30, 2014 our other sales and marketing expenses in the Dominican Republic, excluding Tricom,

increased by 38.1% from €42.3 million to €58.4 million. This increase was primarily due to the volume of retained and new customers in our post-paid segment.

EBITDA: As a result of the factors discussed, for the nine months ended September 30, 2014, our EBITDA in the Dominican Republic, excluding Tricom, was €150.0 million, a 13.9% increase compared to €131.7 million for the nine months ended September 30, 2013. Our EBITDA margin was 45.8% in the nine months ended September 30, 2014 compared to 39.4% in the nine months ended September 30, 2013.

The following tables set forth our EBITDA across our segments for the nine months ended September 30, 2013 and 2014 a pro forma basis.

Pre-PT Transaction Pro Forma Financial Information(5)														
For the nine months ended September 30,														
	2013						2014							
	Israel	Belgium & Luxembourg	Portugal	French Overseas Territories(3)	Dominican Republic(5)	Others(2)	Total	Israel	Belgium & Luxembourg	Portugal	French Overseas Territories(3)	Dominican Republic(5)	Others(2)	Total(4)
	€ in millions													
EBITDA(1)	269.9	35.4	45.1	62.1	131.7	17.7	561.5	314.6	36.3	44.3	72.7	150.0	54.6	672.3

- (1) The Company defines EBITDA as operating profit before depreciation and amortization, goodwill impairment, other expenses, net, management fees, restructuring and other non-recurring costs.
- (2) Comprises (i) €9.8 million and €10.5 million of EBITDA generated by our content production and distribution businesses for the nine months ended September 30, 2013 and 2014, respectively, (ii) €12.9 million and €12.5 million of EBITDA generated by Green Datacenter/Green for the nine months ended September 30, 2013 and 2014, respectively, and (iii) €9.6 million and €5.3 million of negative EBITDA generated by our other holding entities (including corporate expenses) for the nine months ended September 30, 2013 and 2014, respectively. For the nine months ended September 30, 2014, it also comprises the EBITDA generated by the Tricom since March 12, 2014. See note 4 below for details.
- (3) For the nine months ended September 30, 2014, it also includes the contribution of Mobius. See note 3 hereto for details.
- (4) Total EBITDA for the nine months ended September 30, 2014 includes the contribution of Mobius since its consolidation into the Group from January 1, 2014. For the nine months ended September 30, 2014, Mobius generated €3.1 million of EBITDA. Total EBITDA for the nine months ended September 30, 2014 also includes the contribution made by Tricom from March 12, 2014. For the nine months ended September 30, 2014, Tricom generated €40.5 million of EBITDA. Mobius and Tricom did not have any impact on the Pre-PT Transaction Pro Forma Financial Information for the nine months ended September 30, 2013.
- (5) Excludes Tricom.
- (6) Pre-PT Transaction Pro Forma Financial Information for the nine months ended September 30, 2013 and 2014, respectively, gives pro forma effect to the acquisition of ODO, but does not give pro forma effect to the acquisition of PT Portugal, Tricom and Mobius nor the disposal of our mobile network assets in Mayotte and La Réunion which we have committed to undertake. Since the financial information for Tricom and Mobius have been consolidated into the Historical Consolidated Financial Information of the Group from January 1, 2014 and March 12, 2014, respectively, following the consummation of the Mobius Acquisition on January 1, 2014 and the Tricom Acquisition on March, 12, 2014, the Pre-PT/ODO Transactions Pro Forma Financial Information for the nine months ended September 30, 2014 includes the contribution of Tricom and Mobius from the periods for which each of these entities have been consolidated.

Depreciation and Amortization

Historical Consolidated Basis

For the nine months ended September 30, 2014, depreciation and amortization on a historical consolidated basis totaled €397.6 million, a 43.0% increase compared to €278.0 million for the nine months ended September 30, 2013. Depreciation and amortization in the nine months ended September 30, 2014 was impacted by (i) the consolidation of Outremer and ONI for the entire duration of nine months ended September 30, 2014 and (ii) the impact of the consolidation of Tricom and ODO from March 12, 2014 and April 9, 2014, respectively.

Operating Profit

Historical Consolidated Basis

For the nine months ended September 30, 2014, on a historical consolidated basis, (i) management fees primarily relating to consulting services totaled €0.6 million compared to €0.7 million for the nine months ended September 30, 2013 and (ii) restructuring and other non-recurring costs and other expenses totaled €58.5 million compared to restructuring and other non-recurring costs of €12.3 million for the nine months ended September 30, 2013 due to (i) the implementation of cost restructuring measures at ONI, ODO and Tricom, (ii) fees and other expenses paid to external consultants in relation to mergers and acquisitions activity in the first three quarters of 2014 and (iii) due to restructuring costs at HOT Mobile of €15.1 million.

As a result of the factors described above, for the nine months ended September 30, 2014, our operating profit was €170.3 million, compared to an operating profit of €86.1 million for the nine months ended September 30, 2013.

Finance costs (net)

Historical Consolidated Basis

For the nine months ended September 30, 2014, on a historical consolidated basis, our net finance costs totaled €302.2 million, a 104.1% increase compared to €148.1 million for the nine months ended September 30, 2014 which was primarily due to (i) the incurrence of debt to finance the acquisitions of ODO and Tricom (€65.4 million impact for the nine months ended September 30, 2014), (ii) the full period impact of the interest payments relating to the 2013 Term Loan (€32.6 million impact for the nine months ended September 30, 2014) and (iii) the increase in the financial expenses incurred due to the valuation in the market-to-market accounting of the various hedges in place at the Altice International level.

Income tax benefits/(expenses)

Historical Consolidated Basis

For the nine months ended September 30, 2014, on a historical consolidated basis, our total income tax expense was €27.6 million compared to an income tax expense of €27.4 million for the nine months ended September 30, 2013 which was primarily due to an income tax expense of €33.6 million driven by an increase in profits in Israel and the Dominican Republic, which was offset by deferred tax credits of €7.5 million. For the nine months ended September 30, 2013, the income tax expense mainly consisted of deferred tax expenses amounting to €21.9 million.

Profit/(loss) for the period

Historical Consolidated Basis

As a result of the factors discussed above, on a historical consolidated basis, for the nine months ended September 30, 2014, our loss for the period was €159.6 million compared to a loss of €89.4 million for the nine months ended September 30, 2013.

Year Ended December 31, 2013 compared to the Year Ended December 31, 2012

Statement of Income Items	Historical Consolidated Financial Information				Illustrative Aggregated Selected Financial Information	Pre-PT/ODO Transactions Pro Forma Financial Information ⁽¹⁾	Change	
	For the year ended December 31,		Change		For the year ended December 31,	For the year ended December 31,	Amount	%
	2012	2013	Amount	%	2012	2013	Amount	%
	€ in millions except percentages							
Revenue								
Cable based services.....	873.3	891.9	18.6	2.1	945.7	954.7	9.0	1.0
Mobile services.....	172.7	256.2	83.5	48.3	304.4	322.8	18.4	6.0
B2B and others.....	46.4	138.6	92.2	198.7	191.6	183.1	(8.5)	(4.4)
Total Revenue.....	1,092.4	1,286.8	194.3	17.8	1,441.8	1,460.6	18.8	1.3
Purchasing and subcontracting services.....	(302.1)	(367.8)	65.7	21.7	(444.4)	(433.6)	10.8	(2.4)
Gross Profit.....	790.3	918.9	128.6	16.3	997.4	1,027.0	29.6	3.0
Other operating expenses ⁽²⁾	(307.8)	(320.2)	(12.5)	4.0	(315.3)	(293.1)	22.1	(7.1)
General and administrative expenses.....	(33.3)	(36.2)	(2.9)	8.7	(85.1)	(74.6)	10.5	(12.3)
Other sales and marketing expenses.....	(45.9)	(43.9)	2.0	(4.4)	(102.8)	(87.9)	14.9	(14.5)
Operating income before depreciation and amortization.....	403.2	518.8	115.6	28.7	494.2	571.4	77.2	15.6
Depreciation and amortization....	(266.3)	(399.6)	(133.3)	(50.4)	—	(426.7)	—	—
Goodwill impairment.....	(121.9)	—	121.9	—	—	—	—	—
Other expenses, net.....	(29.8)	(15.1)	14.7	49.3	—	(18.6)	—	—
Management fees.....	(6.2)	(0.6)	(5.6)	(90.3)	—	(1.5)	—	—
Restructuring and other non-recurring costs.....	(20.8)	(61.2)	(40.4)	194.2	—	(61.8)	—	—
Operating profit.....	(41.7)	42.3	84.0	201.4	—	62.8	—	—
Finance income.....	30.5	93.6	63.1	206.4	—	93.7	—	—

Finance costs	(204.7)	(336.9)	(132.2)	(64.6)	—	(341.0)	—	—
(Loss)/profit before income tax expenses	(215.8)	(201.0)	5.8	6.9	—	(184.5)	—	—
Income tax benefits/(expenses).	26.0	(7.4)	(33.4)	(128.5)	—	(15.6)	—	—
Loss for the year	(189.8)	(208.4)	(18.6)	(9.8)	—	(200.0)	—	—

- (1) Pre-PT/ODO Transactions Pro Forma Financial Information does not give pro forma effect to the acquisition of PT Portugal, ODO, Tricom and Mobius nor the disposal of our mobile network assets in Mayotte and La Réunion which we have committed to undertake.
- (2) For the Historical Financial Information “Other operating expenses” also includes staff costs and employee benefits expenses. Also includes staff costs and employee benefits expenses. Prior to the year ended December 31, 2013, staff costs and employee benefits were recorded under the line items “Other operating expenses”, “General and administrative expenses” and “Other sales and marketing expenses”, depending on the costs which they related to. Beginning with the year ended December 31, 2013, such staff costs and employee benefits have been accounted for in a separate line item and reflect total staff costs for all functions. See the historical financial statements for the year ended December 31, 2013 elsewhere in these Listing Particulars for further details. For comparative purposes staff and employee costs have been reclassified for the year ended December 31, 2012 to match the new reporting method of the Group. For the Pre-PT/ODO Transactions Pro Forma Financial Information, staff costs and employee benefits expenses are accounted for under the line items “Other operating expenses”, “General and administrative expenses” and “Other sales and marketing expenses”, depending on the costs which they related to.

Significant Events Affecting Historical Results

Our results of operations for the year ended December 31, 2013 and December 31, 2012 were significantly impacted by the following events:

- In February 2012, Altice International acquired a controlling equity interest in Cabovisão (the results of which are consolidated in the Historical Consolidated Financial Information of Altice International with effect from February 29, 2012). Cabovisão contributed €98.2 million to revenue, €20.0 million to operating loss and €29.8 million to EBITDA of the Company on a consolidated basis, in the twelve months ended December 31, 2012 since February 29, 2012. In the first two months of 2012, Cabovisão had €19.8 million of revenue, €1.5 million of operating profit and €2.6 million of EBITDA, which are not consolidated in the Historical Consolidated Financial Information of Altice International. In the first quarter of 2013, Altice International acquired the remaining equity interests in Cabovisão it did not already own.
- In the third quarter of 2013 Altice International acquired a controlling equity interest in Outremer (the financial information of which is consolidated in the Historical Consolidated Financial Information with effect from July 5, 2013). Outremer contributed €102.1 million to revenue, €13.5 million to operating profit and €38.3 million to EBITDA of Altice International on a consolidated basis in the twelve months ended December 31, 2013 since July 5, 2013. For the period from January 1 to July 5, 2013, Outremer had €96.5 million of revenue, €19.4 million of operating profit and €33.2 million of EBITDA, which are not consolidated in the Historical Consolidated Financial Information of the Company.
- In the third quarter of 2013, Altice International acquired a 100% equity interest in ONI (through its indirect subsidiary Cabovisão), the financial information of which is consolidated in the Historical Consolidated Financial Information of Altice International with effect from August 8, 2013. ONI contributed €41.8 million to revenue, €4.9 million to operating loss and €5.7 million to EBITDA of Altice International on a consolidated basis in the twelve months ended December 31, 2013 since August 8, 2013. For the period from January 1 until August 8, 2013, ONI had €59.0 million of revenue, €2.7 million of operating loss and €9.4 million of EBITDA, which are not consolidated in the Historical Consolidated Financial Information of Altice International.
- In the fourth quarter of 2013, Altice International acquired a controlling interest in Ma Chaîne Sport and SportV, two content producers based in France and Luxembourg respectively, the financial information of which is consolidated in the Historical Consolidated Financial Information of Altice International with effect from October 4, 2013. The two entities contributed €6.4 million to revenue, €0.3 million to operating profit and €3.3 million to the EBITDA of Altice International on a consolidated basis in the twelve months ended December 31, 2013 since October 4, 2013. For the period from January 1, 2013 until October 4, 2013, the two companies had €18.3 million of revenue, €2.9 million of operating profit and €10.7 million of EBITDA which are not consolidated in the Historical Consolidated Financial Information of Altice International.

Revenue

Historical Consolidated Basis

For the year ended December 31, 2013, we generated total revenue of € 1,286.8 million, a 17.8% increase compared to €1,092.4 million for the year ended December 31, 2012. Our total revenue by our key regions in the twelve months ended December 31, 2013 and 2012, respectively, were: (i) in Israel, €881.9 million and € 850.4 million, (ii) Belgium and Luxembourg, €72.0 million and €71.3 million, (iii) in Portugal, €150.5 million and €98.2 million (revenue for the year ended December 31, 2012 was impacted by the consolidation of Cabovisão only with effect from February 29, 2012 and revenue for the year ended December 31, 2013 was impacted by the consolidation of ONI only with effect from August 8, 2013), and (iv) in the French Overseas Territories, €126.9 million and €24.4 million (revenue for the year ended December 31, 2012 and 2013 were impacted by the consolidation of Outremer only with effect from July 5, 2013). Foreign exchange translation movements between the NIS and the euro had a positive impact of €29.0 million on total revenue.

Cable based services: For the year ended December 31, 2013, we generated cable based services revenue of €891.9 million, a 2.1% increase compared to €873.3 million for the year ended December 31, 2012. The increase was primarily due to the inclusion of cable based services revenue of €108.7 million from Portugal for the entire duration of twelve months ended December 31, 2013 compared to €98.2 million for the year ended December 31, 2012, following the acquisition of Cabovisão on February 29, 2012, the inclusion of Outremer's cable based services revenue of €27.1 million for the year ended December 31, 2013 (with effect from July 5, 2013). In addition, cable based services revenue increased in Israel due to the factors discussed below. Foreign exchange translation movements between the NIS and the euro had a negative impact of €23.9 million on cable based service revenue.

Mobile services: For the year ended December 31, 2013, we generated mobile services revenue of €256.2 million, a 48.3% increase compared to €172.7 million for the year ended December 31, 2012. This was primarily due to an increase in Israel's mobile services revenue due to the factors discussed below and the inclusion of €67.3 million in mobile services revenue generated by Outremer for the year ended December 31, 2013 (with effect from July 5, 2013). Foreign exchange translation movements between the NIS and the euro had a positive impact of €6.2 million on mobile revenues.

B2B and others: For the year ended December 31, 2013, we generated B2B and other services revenue of €138.6 million, compared to €46.4 million for the year ended December 31, 2012, predominantly due to the inclusion of €41.8 million in B2B services revenue generated by ONI and due to the inclusion of revenue from the content companies Ma Chaîne Sport and SportV acquired in the fourth quarter of 2013 (€6.4 million from October 4, 2013 onwards).

Pro Forma Consolidated Basis and Aggregated Basis

The following table sets forth our revenue by country of operation and on a Pro Forma Consolidated Basis based on the Pre-PT/ODO Transactions Pro Forma Financial Information with respect to the year ended December 31, 2013 and on aggregated basis based on the Illustrative Aggregated Selected Financial Information with respect to the year ended December 31, 2012.

	Illustrative Aggregated Selected Financial Information					Pre-PT/ODO Transactions Pro Forma Financial Information ⁽⁴⁾						
	For the year ended December 31, 2012					For the year ended December 31, 2013						
	Israel	Belgium & Luxembourg	Portugal	French Overseas Territories ⁽²⁾	Others ⁽¹⁾	Israel ⁽³⁾	Belgium & Luxembourg	Portugal	French Overseas Territories ⁽²⁾	Others ⁽¹⁾	Total	
	€ in millions											
Revenue												
Cable based services.....	677.9	59.7	118.0	87.8	2.4	945.7	694.2	60.9	108.7	89.6	1.3	954.7
Mobile Services.....	172.5	0.2	—	131.7	—	304.4	187.6	1.2	—	133.9	—	322.8
B2B and others.....	—	11.5	117.4	—	62.7	191.6	—	8.4	100.9	—	73.9	183.1
Total Revenue.....	850.4	71.3	235.4	219.6	65.2	1,441.8	881.9	70.5	209.6	223.5	75.2	1,460.7

- (1) Others include our B2B telecommunications solutions business and datacenter operations in Switzerland (Green and Green Datacenter), our datacenter operations in France (Auberimmo) and our content production and distribution businesses in France and Luxembourg (Ma Chaîne Sport and SportV). We disposed of our interests in Valvision (which was included in Others) in 2013 to the Numericable Group. Green Datacenter and Auberimmo are designated as unrestricted subsidiaries under the terms governing the indebtedness of the Group.
- (2) For the French Overseas Territories, cable based services includes purchasing and subcontracting services for cable based services we provide in Guadeloupe and Martinique as well as the xDSL based broadband internet (including IPTV) and fixed line telephony services we provide in Guadeloupe, Martinique, French Guiana, La Réunion and Mayotte.
- (3) These numbers are adjusted to eliminate intercompany transactions between HOT Telecom and HOT Mobile in Israel. Such intercompany transactions consist of (i) mobile services sold by HOT Mobile to HOT Telecom and (ii) fixed line telephony services sold by HOT Telecom to HOT Mobile. These transactions were considered to be non-material (below €1 million) until the nine months ended September 30, 2013 as they had no significant impact on the segmental analysis. However, during the fourth quarter of 2013, each of HOT Mobile and HOT Telecom generated revenue from such intercompany transactions which were subject to purchasing and subcontracting services costs that exceeded the materiality threshold. As third party purchasing and subcontracting costs for such intercompany transactions were not

eliminated when showing the cable and mobile segments individually, the adjustments were required to present the actual gross margin figures for each of the segments for the year ended December 31, 2013.

- (4) Pre-PT/ODO Transactions Pro Forma Financial Information does not give pro forma effect to the acquisition of PT Portugal, ODO, Tricom and Mobius nor the disposal of our mobile network assets in Mayotte and La Réunion which we have committed to undertake.

Israel: For the year ended December 31, 2013, we generated total revenue in Israel of €881.9 million, a 3.7% increase compared to €850.4 million for the year ended December 31, 2012. As compared to the year ended December 31, 2012, for the year ended December 31, 2013, our cable based services revenue increased by 2.4% and our mobile services revenue increased by 8.8%. Foreign exchange translation movements between the NIS and euro had a positive impact of €29.0 million on total revenue, €22.8 million on cable services revenue and €6.2 million on mobile services revenue. Accordingly, at a constant exchange rate, our total revenue in Israel remained stable, our cable-based service revenue slightly decreased by 0.2% and our mobile services revenue increased by 6.7%.

Cable based services revenue in Israel was positively impacted due to the increase in cable based services ARPU of 7.2% (3.6% at a constant exchange rate) from €44.4 for the year ended December 31, 2012 to €47.6 for the year ended December 31, 2013 primarily as a result of our strategic focus on multiple-play offerings and an increase in the take-up of our higher value higher speed broadband internet services (despite a decrease in total broadband internet RGUs). We experienced an increase in the number of Cable Customer Relationships subscribing for our triple-play service as a result of our bundling strategy, with the number of triple-play Cable Customer Relationships increasing from 413,000 as of December 31, 2012 to 452,000 as of December 31, 2013. The positive impact of the increase in cable based services ARPU on cable based services revenue was offset by a 48,000 net decrease in our total cable RGUs, comprising a 21,000 net decrease in pay television RGUs, a 27,000 net decrease in broadband internet infrastructure access RGUs. The decrease in our cable RGUs was mainly due to the fact that during July and August 2013, respectively, our third party customer service and technical support provider had not allocated sufficient resources to manage the intake and connection arrangements for potential new subscribers and had focused on providing relevant assistance and support to existing subscribers only. The decrease in the interconnection fees for fixed line telephony starting December 2013, following the change in the regulation from the Ministry of Communication, had a blended impact on the cable based services revenue as the interconnection rate was set at 0.99 agorot per minute for both peak or off peak time calls.

The increase in mobile services revenue in Israel was primarily due to the increase in the number of subscribers for our UMTS based services which were launched in May 2012. For the year ended December 31, 2013, we had 810,000 total mobile RGUs in Israel comprising 218,000 iDEN customers and 592,000 UMTS customers compared to 766,000 mobile customers comprising 325,000 iDEN customers and 441,000 UMTS RGUs as of December 31, 2012. The increase in mobile services revenue was offset by the churn of customers for our iDEN services as a result of decreased marketing efforts and the termination of our contract with the Israeli Defense Force in the third quarter of 2012. The gradual migration of the iDEN subscribers under the expired contract with the Israeli Defense Forces to the new service provider was completed in March 2013. Mobile services revenue was further offset by a decrease in mobile ARPU by €2.6, or 13.4%, to €16.8 for the year ended December 31, 2013 compared to €19.4 for the year ended December 31, 2012, mainly due to subscribers disconnecting from our higher ARPU iDEN mobile network and offset by an increase in our lower ARPU UMTS based network subscribers. Consequently, ARPU from gross-adds to our mobile RGUs were generally lower than the ARPU for customers churned. Mobile ARPU was also negatively impacted by highly competitive prices for mobile services, in particular for UMTS based 3G services. On a constant foreign exchange rate mobile ARPU decreased by 16.2%.

Belgium and Luxembourg: For the year ended December 31, 2013, we generated total revenue in Belgium and Luxembourg of €70.5 million, a 2% decrease compared to €71.3 million for the year ended December 31, 2012. In addition, we launched mobile services (as a MNVO) in Belgium in September 2012 and generated € 1.2 million in mobile services revenue in the year ended December 31, 2013.

The increase in cable based services revenue in Belgium and Luxembourg was primarily due to an increase in cable based ARPU by 6.1% to €41.9 in the year ended December 31, 2013 compared to €39.5 for the year ended December 31, 2012. The increase in cable based services ARPU was due to price increases in our triple-play packages as well as stand-alone pay television offerings. The increase in cable based services revenue can also be attributed to the full period impact of revenues we generated from AIESH, a Belgian municipality, for which we acquired a concession in the third quarter of 2012, to provide pay television services to existing analog customers served by the AIESH network and to upgrade the AIESH network. Cable based services revenue was also positively impacted by a slight increase in broadband internet RGUs which was primarily due to our ability to offer subscribers higher speeds and increased bandwidth capacity compared to providers relying on alternative technologies such as xDSL and mobile broadband internet networks, our attractive pricing of broadband internet services and due to increase in uptake of our triple-play bundles, which includes broadband internet services. These factors were offset by a decline in television RGUs, including a net decrease in digital television RGUs, due to customers churning to different platforms such as digital television providers over DSL and satellite operators, customers terminating their television service or having moved out of

Coditel's network areas. We also experienced a decline in fixed line telephony RGUs due to general the trend of customers switching to mobile services.

The AIESH concession is for a period of 30 years and can be extended for a further period of 20 years. We have upgraded the entire AIESH network and converted the analog customers served by the upgraded AIESH network into digital multiple-play customers. The decrease in B2B and other revenue in Belgium and Luxembourg was primarily due to higher installation fees earned from our project for the Brussels police involving installation of fiber links for the CCTV network in the year ended December 31, 2012, a portion of which reflects non-recurring revenues, slightly offset by an increase in recurring revenue earned for fiber links leased to the Brussels police as part of this project in the twelve months ended December 31, 2013.

Portugal: In the year ended December 31, 2013, we generated total revenue in Portugal of €209.6 million, an 11.0% decrease compared to €235.4 million in the twelve months ended December 31, 2012. As compared to the twelve months ended December 31, 2012, for the year ended December 31, 2013, our revenue in Portugal for our cable based services decreased by 7.9% and our B2B and other services revenue decreased by 14.1%.

The decrease in cable based services revenue in Portugal was primarily driven by a net decrease in total number of cable RGUs by 45,000, comprising of a net decrease of 21,000 pay television RGUs, 20,000 fixed-line telephony RGUs and 3,000 broadband internet RGUs. These were the result of intense competition in the Portuguese cable services market during 2013, with aggressive promotions and pricing policies adopted by competitors and their increased focus on competing multiple-play offerings, as well as the adverse economic conditions and austerity measures in Portugal which had a negative effect on consumer confidence pushing them to opt for cheaper packages. Our strategic decision during the course of 2012 to cease offering certain aggressively priced packages and to migrate customers to triple-play offerings also contributed to the decline in cable RGUs. Cable based services ARPU decreased slightly by €0.3, or 0.9%, to €34.6 in 2013 compared to €34.9 in 2012, predominantly due to the impact of aggressive competition in each segment of the cable services market which required us to offer certain discounts and undertake other promotional offers, despite an increase in the prices of our products in January 2013. As a result, the ARPU from gross-adds to our RGUs were generally lower than the ARPU for customers churned. We have implemented certain measures which are aimed at improving our competitive position in future periods, including improvements to our website which will enable customers to directly subscribe for our products online, rolling out additional stores and entering into arrangements with distributors (primarily supermarkets). There can however be no assurance that these measures will be successful in achieving RGU or ARPU growth in future periods.

The decrease in B2B and other revenue in Portugal was primarily due to the lower level of business with carriers (transit) and sales of equipment that occurred in 2012, linked to certain specific projects undertaken by ONI during this period.

French Overseas Territories: For the year ended December 31, 2013, we generated total revenue in the French Overseas Territories of € 223.5 million, a 1.8% increase compared to €219.6 million for the year ended December 31, 2012. As compared to the twelve months ended December 31, 2012, for the year ended December 31, 2013, our revenue in the French Overseas Territories for our cable based services increased by 2.1% and our mobile services revenue increased by 1.7%.

The €1.8 million increase in cable based services revenue in the French Overseas Territories was due to (i) a €2.4 million decrease in fixed-line revenue of Outremer, which in turn was mainly as a result of a net decrease of 5,000 fixed-line telephony RGUs due to continuation in the trend of customers switching from traditional voice telephony towards multiple-play VoIP packages and (ii) a €1.9 million decrease in broadband internet services revenue of Outremer which in turn was mainly as a result of a net decrease of 2,000 xDSL broadband internet RGUs due to increased competition particularly in La Reunion and the limited ability and marketing investment to provide triple-play services, limited marketing innovation in Outremer's broadband internet product line and the limited nature of IPTV provided to DSL broadband internet customers prior to the integration of Outremer in the Group. This was partially offset by a 6.4% increase in cable based services ARPU with respect to our cable based services offered by Le Cable in Guadeloupe and Martinique to €51.4 for the year ended December 31, 2013 compared to €48.3 for the year ended December 31, 2012 and a net increase of 10,000 total cable RGUs during this period largely as a result of our strategic focus on triple-play offerings and an increase in triple-play Cable Customer Relationships to 17,000 as of December 31, 2013 from 12,000 as of December 31, 2012.

The €2.2 million increase in mobile services revenue in the French Overseas Territories, all of which is attributable to Outremer, was primarily due to a net increase of 14,000 post-paid mobile subscribers over the period, offset by a decline in prepaid mobile subscribers. This increase was a result of the revamping of Outremer's mobile post-paid offering, particularly due to the success of flat-fee rate plans with unlimited calls within the French Overseas Territories and mainland France, which Outremer introduced in the first half of 2012 as well as a decrease in termination rates. Mobile ARPUs increased slightly by €0.4 primarily due to the improvement in product mix with greater demand of Outremer's higher value post paid packages following the revamping of its mobile product offering despite the sharp decrease in

mobile termination rates from €0.028 in 2012 to €0.01 in 2013 prescribed by the French national regulatory authority for electronic communications, the ARCEP resulting in lower mobile interconnection revenues.

Gross Profit

Historical Consolidated Basis

For the year ended December 31, 2013, our total gross profit was €918.9 million, a 16.3% increase compared to €790.3 million for the year ended December 31, 2012. Our gross profit by our key regions in the twelve months ended December 31, 2013 and 2012, respectively, were: (i) in Israel, €644.4 million and €621.7 million, (ii) Belgium and Luxembourg, €59.1 million and €60.3 million, (iii) in Portugal, €92.1 million and €59.1 million (gross profit for the year ended December 31, 2012 was impacted by the consolidation of Cabovisão only with effect from March 1, 2012 and gross profit for the year ended December 31, 2012 and 2013 was impacted by the consolidation of ONI only with effect from August 8, 2013), and (iv) in the French Overseas Territories, €89.8 million and €20.4 million (gross profit for the year ended December 31, 2012 and 2013 was impacted by the consolidation of Outremer only with effect from July 5, 2013). Our gross margin decreased from 72.3% in the twelve months ended December 31, 2012 to 71.4% in the twelve months ended December 31, 2013. Foreign exchange translation movements between the NIS and the euro had a positive impact of €21.0 million on total gross profit.

Cable based services: For the year ended December 31, 2013, our gross profit from our cable based services was €712.3 million, a 7.9% increase compared to €660.4 million for the year ended December 31, 2012. The increase was primarily due to the inclusion of cable based services gross profit from Portugal for the entire duration of the twelve months ended December 31, 2013 of €74.6 million compared to €59.1 million for the year ended December 31, 2012, following the acquisition of Cabovisão on February 28, 2012, and an increase in Israel's gross profit due to the factors discussed below. Foreign exchange translation movements between the NIS and the euro had a positive impact of €18.4 million on cable based services gross profit. Our gross margin for cable based services increased from 75.6% in the twelve months ended December 31, 2012 to 79.9% in the year ended December 31, 2013.

Mobile services: For the year ended December 31, 2013, our gross profit from our mobile services increased to €126.4 million compared to €102.8 million in the previous year. Although we saw a decrease in gross profit of €22.9 million in Israel, due to the factors discussed below, it was offset by the inclusion of gross profit of €46.1 million of Outremer's mobile services with effect from July 5, 2013. Our gross margin for mobile services decreased from 59.5% in the twelve months ended December 31, 2012 to 49.3% in the year ended December 31, 2013. Foreign exchange translation movements between the NIS and the euro had a positive impact of €2.6 million on mobile services gross profit.

B2B and others: For the year ended December 31, 2013, our gross profit from B2B and others was €80.2 million, a 195.9% increase compared to €27.1 million for the year ended December 31, 2012. Our gross margin for B2B and other services decreased from 57.9% in the year ended December 31, 2013 to 58.4% in the year ended December 31, 2012. The increase in gross profit was primarily due to the inclusion of B2B services gross profit of €17.5 million generated by ONI and €5.0 million gross profit generated by the content companies MCS and SportV.

Pro Forma Consolidated Basis and Aggregated Basis

The following table sets forth our purchasing and subcontracting services by country of operation and on a Pro Forma Consolidated Basis based on the Pre- PT/ODO Transactions Pro Forma Financial Information with respect to the year ended December 31, 2013 and on an aggregated basis based on the Illustrative Aggregated Financial Information with respect of the year ended December 31, 2012.

	Illustrated Aggregated Selected Financial Information					Pre PT/ODO Transactions Pro Forma Financial Information ⁽⁴⁾						
	For the year ended December 31, 2012					For the year ended December 31, 2013						
	Israel	Belgium & Luxembourg	Portugal	French Overseas Territories ⁽²⁾	Others ⁽¹⁾	Total	Israel	Belgium & Luxembourg	Portugal	French Overseas Territories ⁽²⁾	Others ⁽¹⁾	Total
	€ in millions											
Purchasing and subcontracting services												
Cable based services.....	159.0	10.3	47.9	26.5	0.5	244.2	129.6	10.6	34.1	25.1	0.3	199.7
Mobile Services.....	69.8	0.1	—	41.5	—	111.4	107.8	0.9	—	41.7	—	150.4
B2B and others.....	—	0.6	66.8	—	21.5	88.9	—	1.0	55.6	—	26.5	83.0
Total purchasing and subcontracting services.....	228.8	11.0	114.7	68.0	22.0	444.5	237.4	12.9	89.7	66.8	27.1	433.5

(1) Others include our B2B telecommunications solutions business and datacenter operations in Switzerland (Green and Green Datacenter), our datacenter operations in France (Auberimmo) and our content production and distribution businesses in France and Luxembourg (Ma Chaîne Sport and SportV). We disposed of our interests in Valvision (which was included in Others) in 2013 to the Numericable Group. Green Datacenter and Auberimmo are designated as unrestricted subsidiaries under the terms governing the indebtedness of the Group.

- (2) For the French Overseas Territories, cable based services includes purchasing and subcontracting services for cable based services we provide in Guadeloupe and Martinique as well as the xDSL based broadband internet (including IPTV) and fixed-line telephony services we provide in Guadeloupe, Martinique, French Guiana, La Réunion and Mayotte.
- (3) These numbers are adjusted to eliminate intercompany transactions between HOT Telecom and HOT Mobile in Israel. Such intercompany transactions consist of (i) mobile services sold by HOT Mobile to HOT Telecom and (ii) fixed line telephony services sold by HOT Telecom to HOT Mobile. These transactions were considered to be non-material (below €1 million) up until the nine months ended September 30, 2013 as they had no significant impact on the segmental analysis. However, during the fourth quarter of 2013, each of HOT Mobile and HOT Telecom generated revenue from such intercompany transactions which were subject to purchasing and subcontracting services costs that exceeded the materiality threshold. As third party purchasing and subcontracting costs for such intercompany transactions were not eliminated when showing the cable and mobile segments individually, the adjustments were required to present the actual gross margin figures for each of the segments for the year ended December 31, 2013.
- (4) Pre-PT/ODO Transactions Pro Forma Financial Information does not give pro forma effect to the acquisition of PT Portugal, ODO, Tricom and Mobius nor the disposal of our mobile network assets in Mayotte and La Réunion which we have committed to undertake.

Israel: For the year ended December 31, 2013, our purchasing and subcontracting services costs in Israel were €237.4 million, a 3.8% increase compared to €228.8 million for the year ended December 31, 2012. As compared to the year ended December 31, 2012, for the year ended December 31, 2013, our purchasing and subcontracting services costs for cable based services decreased by 18.5% and our purchasing and subcontracting services costs for mobile services increased by 54.4%. Foreign exchange translation movements between NIS and euro had the impact of increasing purchasing and subcontracting services costs by €7.8 million (including €4.2 million of cable based services purchasing and subcontracting services costs and €3.6 million of mobile services purchasing and subcontracting services costs). Accordingly, at a constant exchange rate, our total purchasing and subcontracting services costs in Israel increased by 0.4%, our cable based service purchasing and subcontracting services costs decreased by 20.5% and our cellular services revenue increased by 52.5%.

The decrease in purchasing and subcontracting services costs for cable based services in Israel was primarily due to a decrease in interconnection fees paid as a result of lower call volumes by our customers due to customers switching from fixed-line telephony services to mobile services, as a result of the competitive prices and unlimited price plan packages, and a decrease in the royalties paid to the State of Israel following the regulations enacted under the Communications Law pursuant to which the rate of royalties applicable to our cable telecommunication licenses have been reduced to 0% with effect from January 2, 2013. Purchasing and subcontracting services costs for cable based services also decreased due to the positive effect of renegotiated movie channels contracts and the capitalization of costs arising from the purchase of exclusive third party content from April 1, 2013, as previously, we were able to capitalize exclusive in-house content costs only. In the twelve months ended December 31, 2013 we capitalized €7.7 million of costs relating to exclusive third party content.

The increase in purchasing and subcontracting services costs for mobile services in Israel was primarily due to an increase in interconnection fees of €81.5 million we incurred in the twelve months ended December 31, 2013, with respect to our 3G mobile services which was launched in May 2012 compared to €43.7 million in the twelve months ended December 31, 2012. Interconnection fees in the year ended December 31, 2013 included national roaming costs of €49.8 million compared to €21.4 million in the year ended December 31, 2012.

Belgium and Luxembourg: For the year ended December 31, 2013, our purchasing and subcontracting services costs in Belgium and Luxembourg were €12.6 million, a 14.5% increase compared to €11.0 million for the year ended December 31, 2012. As compared to the year ended December 31, 2012, for the year ended December 31, 2013, our purchasing and subcontracting services costs for cable based services increased by 2.9% and our purchasing and subcontracting services costs for B2B services increased by 25.0% (from €0.8 million to €1.0 million). We began providing mobile services in Belgium in September 2012 as a MVNO and incurred costs of sales in an amount of €0.9 million in the twelve months ended December 31, 2013.

The increase in purchasing and subcontracting services costs for cable based services in Belgium resulted from (i) the increase in the cost of certain French channels in Belgium and (ii) the inclusion of cost of sales incurred in relation to the migration of AIESH customers from analogue to digital ports during 2013.

The increase in purchasing and subcontracting services costs for mobile services in Belgium and Luxembourg was due to an increase in expenses associated with (i) the launch of our mobile operation in September 2012 and the full year impact of its operations in 2013 and (ii) the payments made to Mobistar under the MNVO agreement.

The increase in cost of sale for B2B services and others in Belgium and Luxembourg was due to (i) the nature of B2B projects undertaken in 2013 as compared to the same period in the previous year (for which costs were primarily in the form of capital expenditures) and (ii) promotional offers and incentives in responses to the strategy adopted by our competitors.

Portugal: For the year ended December 31, 2013, our purchasing and subcontracting services costs in Portugal was €89.7 million, a 21.8% decrease compared to €114.7 million for the year ended December 31, 2012. As compared to the year ended December 31, 2012, for the year ended December 31, 2013, our purchasing and subcontracting services costs for cable based services decreased by 28.8% and our purchasing and subcontracting services costs for B2B and others decreased by 16.8%.

The 28.8% decrease in purchasing and subcontracting services costs for cable based services in Portugal can primarily be attributed to the larger impact in the year ended December 31, 2013 compared to the prior year of an operational optimization program implemented by the Group following the acquisition of Cabovisão in February 2012, which included savings through renegotiations of television content rights.

The 16.8% decrease in costs of sales for B2B and others in Portugal was due to the higher level of ONI's business with carriers (transit) and sales of equipment in the year ended December 31, 2012, which are projects that inherently have a lower gross profit margin. Also, during the last quarter 2013, some savings were achieved as a result of the measures undertaken to implement a cost reduction which are still ongoing.

French Overseas Territories: For the year ended December 31, 2013, our purchasing and subcontracting services costs in the French Overseas Territories were €66.8 million, a 1.8% decrease compared to €68.0 million for the year ended December 31, 2012. As compared to the year ended December 31, 2012, for the year ended December 31, 2013, our purchasing and subcontracting services costs for cable based services decreased by 5.3% and our purchasing and subcontracting services costs for mobile services increased by 0.5%.

The decrease in purchasing and subcontracting services costs for cable based services in the French Overseas Territories was primarily due to the decrease in interconnection rates and the decrease in Outremer's fixed-line telephony and xDSL broadband internet RGUs.

The increase in costs of sales for mobile services in the French Overseas Territories was mainly due to the increase in post-paid RGUs and interconnections costs with the success of Outremer's flat-fee rate plans which include unlimited calls, and was partially offset by the decrease in termination rates.

As a result of the factors described above, our gross profit and gross margin by country of operation on a Pro Forma Consolidated Basis based on the Pre- PT/ODO Transactions Pro Forma Financial Information for the year ended December 31, 2013 and on an aggregated basis based on the Illustrative Aggregated Selected Financial Information for the year ended December 31, 2012 was as follows:

	Illustrative Aggregated Selected Financial Information						Pre-PT/ODO Transactions Pro Forma Financial Information ⁽⁴⁾					
	For the year ended December 31, 2012						For the year ended December 31, 2013					
	Israel	Belgium & Luxembourg	Portugal	French Overseas Territories ⁽²⁾	Others ⁽¹⁾	Total	Israel ⁽³⁾	Belgium & Luxembourg	Portugal	French Overseas Territories ⁽²⁾	Others ⁽¹⁾	Total
	€ in millions											
Gross profit												
Cable based services.....	518.9	49.6	70.1	61.3	1.9	701.9	564.6	50.2	74.5	64.5	1.0	754.9
Mobile Services.....	102.7	0.1	—	90.2	—	193.0	79.8	0.3	—	92.2	—	172.4
B2B and others.....	—	10.6	50.6	—	41.2	102.4	—	7.3	45.3	—	47.2	99.8
Total gross profit.....	621.7	60.3	120.7	151.5	43.1	997.4	644.4	57.9	119.8	156.7	48.2	1,027.0

	Illustrative Aggregated Selected Financial Information						Pre-PT/ODO Transactions Pro Forma Financial Information ⁽⁴⁾					
	For the year ended December 31, 2012						For the year ended December 31, 2013					
	Israel	Belgium & Luxembourg	Portugal	French Overseas Territories ⁽²⁾	Others ⁽¹⁾	Total	Israel ⁽³⁾	Belgium & Luxembourg	Portugal	French Overseas Territories ⁽²⁾	Others ⁽¹⁾	Total ⁽⁴⁾
	€ in millions											
Gross margin												
Cable based services												
(%)	76.5	83.1	59.4	69.8	79.5	74.2	81.3	82.4	68.5	72.0	76.9	79.1
Mobile Services (%)...	59.5	50.0	—	68.5	—	63.4	42.6	25.0	—	68.9	—	53.4
B2B and others (%)....	—	92.2	43.1	—	65.7	53.5	—	86.9	44.9	—	63.7	54.5
Total gross margin												
(%)	73.1	84.6	51.3	69.0	66.1	69.2	73.1	82.1	57.2	70.1	64.0	70.3

(1) Others include our B2B telecommunications solutions business and datacenter operations in Switzerland (Green and Green Datacenter), our datacenter operations in France (Auberimmo) and our content production and distribution businesses in France and Luxembourg (Ma Chaîne Sport and SportV). We disposed of our interests in Valvision (which was included in Others) in 2013 to the Numericable Group. Green Datacenter and Auberimmo are designated as unrestricted subsidiaries under the terms governing the indebtedness of the Group.

(2) For the French Overseas Territories, cable based services includes gross profit and gross margin for cable based services we provide in Guadeloupe and Martinique as well as the xDSL based broadband internet (including IPTV) and fixed-line telephony services we provide in Guadeloupe, Martinique, French Guiana, La Réunion and Mayotte.

(3) These numbers are adjusted to eliminate intercompany transactions between HOT Telecom and HOT Mobile in Israel. Such intercompany transactions consist of (i) mobile services sold by HOT Mobile to HOT Telecom and (ii) fixed line telephony services sold by HOT Telecom to HOT Mobile. These transactions were considered to be non-material (below €1 million) up until the nine months ended September 30, 2013 as they had no significant impact on the segmental analysis. However, during the fourth quarter of 2013, each of HOT Mobile and HOT Telecom generated revenue from such intercompany transactions which were subject to purchasing and subcontracting services costs that exceeded the materiality threshold. As third party purchasing and subcontracting costs for such intercompany transactions were not eliminated when showing the cable and mobile segments individually, the adjustments were required to present the actual gross margin figures for each of the segments for the year ended December 31, 2013.

(4) Pre-PT/ODO Transactions Pro Forma Financial Information does not give pro forma effect to the acquisition of PT Portugal, ODO, Tricom and Mobius nor the disposal of our mobile network assets in Mayotte and La Réunion which we have committed to undertake.

Foreign exchange translation movements between the NIS and euro had a positive impact of €21.1 million on total gross profit in Israel, €18.5 million for cable based services and €2.6 million for mobile services.

Operating Expenses and EBITDA

Historical Consolidated Basis

For the year ended December 31, 2013, our total operating expenses (other than purchasing and subcontracting services costs) were €400.2 million, a 3.4% increase compared to €387.1 million for the year December 31, 2012. Our total operating expenses comprise of other operating expenses, which increased by 4%, general and administrative expenses, which increased by 8.7% and other sales and marketing expenses, which decreased by 4.4%, in each case in the year ended December 31, 2013 compared to the year ended December 31, 2012.

Our total operating expenses by our key regions in the year ended December 31, 2012 and 2013, respectively, were: (i) in Israel, €316.5 million and €281.7 million, (ii) Belgium and Luxembourg, €14.7 million and €12.9 million, (iii) in Portugal, €29.2 million and €43.0 million (operating expenses for the year ended December 31, 2012 was impacted by the consolidation of Cabovisão only with effect from March 1, 2012 and operating expenses for the years ended December 31, 2012 and 2013 were impacted by the consolidation of ONI only with effect from August 8, 2013), and (iv) in the French Overseas Territories, €8.3 million and €40.5 million (operating expenses for the years ended December 31, 2012 and 2013 were impacted by the consolidation of Outremer only with effect from July 5, 2013).

We define EBITDA in our Historical Consolidated Financial Statements as operating profit before depreciation and amortization, goodwill impairment, other expenses, net, management fees and restructuring and other non-recurring costs. We define Adjusted EBITDA as EBITDA before equity based compensation expenses.

As a result, for the year ended December 31, 2013, our EBITDA increased to €518.8 million a 28.7% increase compared to € 403.2 million for the year ended December 31, 2012. Our EBITDA by our key regions for the years ended December 31, 2012 and 2013, respectively, were: (i) in Israel, €305.2 million and € 362.8 million, (ii) Belgium and Luxembourg, €45.6 million and €46.5 million, (iii) in Portugal, €29.8 million and €49.1 million (EBITDA for the year ended December 31, 2012 was impacted by the consolidation of Cabovisão only with effect from March 1, 2012 and EBITDA for the years ended December 31, 2012 and 2013 were impacted by the consolidation of ONI only with effect from August 8, 2013), and (iv) in the French Overseas Territories, € 12.1 million and €49.3 million due to the fact that

EBITDA for the year ended December 31, 2013 were impacted by the consolidation of Outremer only with effect from July 5, 2013. Our EBITDA margin for the year ended December 31, 2013 was 40.3% compared to 36.9% for the year ended December 31, 2012.

Pro Forma Consolidated Basis and Aggregated Basis

The following paragraphs set forth our total operating expenses by country of operation and on a pro forma consolidated basis based on the Pre-PT/ODO Transactions Pro Forma Financial Information for the year ended December 31, 2013 and on an aggregated basis based on the Illustrative Aggregated Selected Financial Information for the year ended December 31, 2012.

For the year ended December 31, 2013, our total operating expenses were €455.6 million, a 9.5% decrease compared to €503.1 million for the year ended December 31, 2012.

Israel: For the year ended December 31, 2013, our total operating expenses in Israel were €281.7 million, an 11.0% decrease compared to €316.5 million for the year ended December 31, 2012. Foreign exchange translation movements between NIS and euro had the impact of increasing operating expenses by €6.6 million. Accordingly, at a constant exchange rate, our total operating expenses in Israel decreased by 11.6%.

Other operating expenses: As compared to the year ended December 31, 2012, for the year ended December 31, 2013 our other operating expenses in Israel decreased by 8.6% from €223.4 million to €204.1 million. This decrease was primarily due to a decrease in salaries and social benefits and a reduction in head count as part of the measures implemented to maximize cost structure efficiency. In addition, in July 2013, our customer services and technical support functions were outsourced which also contributed to the decrease in salaries and social benefits expenses. We were able to apply these measures due to an increase in the quality of our network resulting from recent investments in the improvement of our technical service systems. The decrease of other operating expenses was also impacted by a decrease in cable network maintenance and set-top box maintenance expenses due to recent investments leading to the improvement of our network and a more efficient maintenance process for set-top boxes.

General and administrative expenses: As compared to the year ended December 31, 2012, for the year ended December 31, 2013 our general and administrative expenses in Israel decreased by 6.1% from €29.3 million to €27.5 million. This decrease was primarily as a result of a decrease in salary and social benefits expenses due to a reduction in administrative personnel and equity based compensation of €3.8 million in the year ended December 31, 2012 pertaining to HOT stock options.

Other sales and marketing expenses: As compared to the year ended December 31, 2012, for the year ended December 31, 2013 our other sales and marketing expenses in Israel decreased by 21.7% from €63.7 million to €49.9 million. Compared to the prior year period, our sales and marketing expenses decreased as a result of a decrease in sales commissions to retailers, advertising costs and sales promotions and decreases in salaries and social benefits of sales personnel resulting from the measures implemented to maximize cost structure efficiency.

EBITDA: As a result of the factors discussed above, for the year ended December 31, 2013, in Israel our EBITDA was €363.0 million, a 18.8% increase compared to €305.2 million for the year ended December 31, 2012 and our EBITDA margin was 41.1% in the twelve months ended December 31, 2013 compared to 35.9% in the twelve months ended December 31, 2012. Foreign exchange translation movements between the NIS and euro had a positive impact of €11.8 million on total EBITDA.

Belgium and Luxembourg: For the year ended December 31, 2013, our total operating expenses in Belgium and Luxembourg were €12.9 million, a decrease of 12.2% compared to €14.7 million for the year ended December 31, 2012.

Other operating expenses: As compared to the twelve months ended December 31, 2012, for the year ended December 31, 2013 our other operating expenses in Belgium and Luxembourg decreased from €6.2 million to €5.3 million. This decrease was primarily due to a decrease in customer service costs as a result of measures undertaken by our management to improve the efficiency in handling and resolving “first-time” complaints.

General and administrative expenses: General and administrative costs remained stable at €4.1 million for the years ended December 31, 2013 and 2012 respectively.

Other sales and marketing expenses: As compared to the year ended December 31, 2012, for the year ended December 31, 2013 our other sales and marketing expenses in Belgium and Luxembourg decreased from €4.4 million to €3.4 million. This decrease can be attributed to the capitalization of sales commissions (only on the sales target), a practice that was implemented from 2013 onwards, offset by certain sales and marketing expenses associated with the launch of ‘LaBox’ in Q3 2013.

EBITDA: As a result of the factors discussed above, for the year ended December 31, 2013, our EBITDA in Belgium and Luxembourg was € 45.0 million, a 1.3% decrease compared to €45.6 million for the year ended December 31, 2012. Our EBITDA margin was 63.9% in the twelve months ended December 31, 2013 compared to 64.0% in the twelve months ended December 31, 2012.

Portugal

In the twelve months ended December 31, 2013, our total operating expenses in Portugal were €61.5 million, 15.4% decrease compared to €72.7 million for the year ended December 31, 2012. This decrease was due to the larger impact in the twelve months ended December 31, 2013, compared to the prior year period, of an operational optimization program implemented by the Group following the acquisition of Cabovisão in February 2012 and a reduction in operational expenses by ONI, from €36.8 million for the year ended December 31, 2012 to €30.4 million for the year ended December 31, 2013 achieved as a result of the optimization efforts in several areas.

Other operating expenses: As compared to the twelve months ended December 31, 2012, for the year ended December 31, 2013 our other operating expenses in Portugal increased slightly to €38.6 million compared to €38.3 million for the year ended December 31, 2012 due to the reallocation of certain salary expenses for technical personnel.

General and administrative expenses: As compared to the twelve months ended December 31, 2012, for the year ended December 31, 2013 our general and administrative expenses in Portugal decreased by 40.6% from €21.8 million to €12.8 million. This decrease was primarily due to savings from headcount reductions in corporate and administrative staff and savings through cancelation and renegotiation of certain contracts for administrative services, in each case mainly relating to Cabovisão.

Other sales and marketing expenses: As compared to the twelve months ended December 31, 2012, for the year ended December 31, 2013 our other sales and marketing expenses in Portugal decreased by 20.6% from €12.6 million to €10.0 million. This decrease was mainly due to the cancelation and renegotiation of certain marketing and advertising contracts and headcount reduction in sales personnel, in each case relating to Cabovisão.

EBITDA: As a result of the factors discussed, in 2013, our EBITDA in Portugal was €58.3 million, a 21.5% increase compared to €47.9 million in 2012. Our EBITDA margin was 27.8% in the twelve months ended December 31, 2013 compared to 20.4% in the twelve months ended December 31, 2012.

French Overseas Territories: For the year ended December 31, 2013, our total operating expenses in the French Overseas Territories were €72.2 million, a 5.5% decrease compared to €76.4 million for the year ended December 31, 2012.

Other operating expenses: As compared to the twelve months ended December 31, 2012, for the year ended December 31, 2013 our other operating expenses in the French Overseas Territories decreased by 15.3% from €45.1 million to €38.2 million. This decrease was primarily due to measures taken by Outremer to optimize its fixed costs, including to reduce payroll through (i) automated cash recovery systems with the roll-out of self-service payment machines in each of its 81 outlets, (ii) reallocation of customer care staff from local centers in the French Overseas Territories to its offshoring center in Mauritius, thereby reducing headcount in the French Overseas Territories and (iii) an increased use of online self-care systems. These cost savings were partially offset by increased costs related to measures taken to improve its quality of service, in particular the densification of mobile networks.

General and administrative expenses: As compared to the twelve months ended December 31, 2012, for the year ended December 31, 2013 our general and administrative expenses in the French Overseas Territories increased by 17.6% from €11.9 million to €14.0 million. This increase was primarily due to a non-recurring expense indirectly related to the acquisition of Outremer by Altice International.

Other sales and marketing expenses: As compared to the twelve months ended December 31, 2012, for the year ended December 31, 2013 our other sales and marketing expenses in the French Overseas Territories increased by 2.6% from €19.5 million to €20.0 million. This increase can be attributed to the launch of new cable-based products in Martinique and Guadeloupe and the launch of new mobile post-paid offers in La Réunion during the fourth quarter of 2013.

EBITDA: As a result of the factors discussed, for the year ended December 31, 2013, our EBITDA in the French Overseas Territories was €84.5 million, a 12.5% increase compared to €75.1 million for the year ended December 31, 2012. Our EBITDA margin was 37.8% in the year ended December 31, 2013 compared to 34.2% in the year ended December 31, 2012.

The following tables set forth our EBITDA across our segments for the years ended December 31, 2012 and 2013 on an aggregated basis and on a pro forma basis, respectively.

	Illustrative Aggregated Selected Financial Information						Pre-PT/ODO Transactions Pro Forma Financial Information ⁽⁴⁾					
	For the year ended December 31, 2012						For the year ended December 31, 2013					
	Israel ⁽³⁾	Belgium & Luxembourg	Portugal	French Overseas Territories	Others ⁽²⁾	Total	Israel ⁽³⁾	Belgium & Luxembourg	Portugal	French Overseas Territories	Others ⁽²⁾	Total
EBITDA ⁽¹⁾	305.2	45.6	48.0	75.1	20.3	494.2	363.0	45.0	58.3	84.6	20.0	570.9

- (1) The Company defines EBITDA as operating profit before depreciation and amortization, goodwill impairment, other expenses, net, management fees and restructuring and other non-recurring costs.
- (2) Comprises (i) €9.8 million and €13.4 million of EBITDA generated by our content production and distribution businesses for the year ended December 31, 2012 and 2013, respectively, (ii) €15.5 million and €16.4 million of EBITDA generated by Green Datacenter/Green for the year ended December 31, 2012 and 2013 and (iii) €5.0 million and €11.2 million of negative EBITDA generated by our other holding entities (including corporate expenses) for the year ended December 31, 2012 and 2013, respectively.
- (3) In Israel, costs relating to the purchase of exclusive third party content have only been capitalized with effect from April 1, 2013. Consequently, EBITDA for the year ended December 31, 2012 reflects costs relating to the purchase of exclusive third party content for the entire period and EBITDA for the year ended December 31, 2013 reflects costs relating to the purchase of exclusive third party content incurred in the period prior to April 1, 2013.
- (4) Pre-PT/ODO Transactions Pro Forma Financial Information does not give pro forma effect to the acquisition of PT Portugal, ODO, Tricom and Mobius nor the disposal of our mobile network assets in Mayotte and La Réunion which we have committed to undertake.

	Illustrative Aggregated Selected Financial Information	Pre-PT/ODO Transactions Pro Forma Financial Information ⁽²⁾
	For the year ended December 31,	
	2012	2013
	€ in millions	
EBITDA	494.2	570.9
Equity based compensation ⁽¹⁾	3.8	—
Adjusted EBITDA	498.0	570.9

- (1) Equity-based compensation consists of expenses pertaining to employee stock options provided to employees in Israel.
- (2) Pre-PT/ODO Transactions Pro Forma Financial Information does not give pro forma effect to the acquisition of PT Portugal, ODO, Tricom and Mobius nor the disposal of our mobile network assets in Mayotte and La Réunion which we have committed to undertake.

Depreciation and Amortization

Historical Consolidated Basis

For the year ended December 31, 2013, depreciation and amortization on a historical consolidated basis totaled €399.6 million, a 50.1% increase compared to €266.3 million for the year ended December 31, 2012. Depreciation and amortization in the twelve months ended December 31, 2013 was impacted by (i) the acquisitions and subsequent consolidation of Outremer (with effect from July 5, 2013) and ONI (with effect from August 8, 2013) and (ii) the impact of the consolidation of Cabovisão for the entire nine months period, following its acquisition on February 29, 2012. However, the increase in depreciation and amortization as a result of the above factors were more than offset due to the recognition of an impairment charge in 2012 of NIS 604 million (€121.9 million equivalent) as a result of a valuation by Cool Holding, with the assistance of an external appraiser, pursuant to which Cool Holding concluded that the recoverable amount of the in-country fixed line communication segment was lower than its carrying amount.

Operating Profit/(Loss)

Historical Consolidated Basis

For the year ended December 31, 2013, on a historical consolidated basis, (i) other expenses, net totaled €15.1 million, a 49.3% decrease compared to €29.8 million for the year ended December 31, 2012; (ii) management fees primarily relating to consulting services totaled €0.6 million compared to €6.2 million for the year ended December 31, 2012 and (iii) restructuring and other non recurring costs totaled €61.2 million compared to restructuring and other non recurring costs of €20.8 million for the year ended December 31, 2012 (primarily due to the implementation of a reorganization implemented at ONI, fees and other outlays paid to external consultants in relation to the increased mergers and

acquisition activity in 2013 compared to 2012 and due to a one- off provision at HOT Mobile of €31.6 million relating to its agreement with Pelephone).

As a result of the factors described above, for the year ended December 31, 2013, our operating profit was €42.3 million, compared to an operating loss of €41.7 million for the year ended December 31, 2012.

Finance costs (net)

Historical Consolidated Basis

For the year ended December 31, 2013, on a historical consolidated basis, our net finance costs totalled €243.3 million, a 39.9% increase compared to €173.9 million for the year ended December 31, 2012 which was primarily due to (i) the incurrence of new debt to finance the Outremer Telecom and ONI transactions (€12.9 million impact in 2013) and (ii) the full year impact of the debt incurred to finance the HOT take private in 2012 (€47.45 million in 2013), offset slightly by a positive impact of the gain on foreign exchange transactions.

Income tax benefits/(expenses)

Historical Consolidated Basis

For the year ended December 31, 2013, on a historical consolidated basis, our total income tax expense was €7.4 million compared to an income tax benefit of €26.0 million for the year ended December 31, 2012 which was primarily due to higher income tax expense in Israel due to higher profit before tax, the increase in the tax rate from 25% in 2012 to 26.5% in 2013 and a decrease in deferred tax assets.

Loss for the year

Historical Consolidated Basis

As a result of the factors discussed above, on a historical consolidated basis, for the year ended December 31, 2013, our loss for the year was €208.4 million compared to a loss of €189.8 million for the year ended December 31, 2012.

Year Ended December 31, 2012 compared to the Year Ended December 31, 2011

Statement of Income Items	Historical Consolidated Financial Information				Illustrative Aggregated Selected Financial Information			
	For the year ended December 31,		Change		For the year ended December 31,		Change	
	2011	2012	Amount	%	2011	2012	Amount	%
	€ in millions except percentages							
Revenue								
Cable based services.....	560.3	873.3	313.0	55.9	941.2	945.7	4.5	0.5
Mobile services.....	180.6	172.7	(7.9)	(4.4)	306.5	304.4	(2.1)	(0.7)
B2B and others	43.3	46.4	3.1	7.2	178.5	191.6	13.1	7.3
Total Revenue	784.2	1,092.4	308.2	39.3	1,426.2	1,441.8	15.6	1.1
Purchasing and subcontracting services	(175.4)	(302.1)	(126.7)	(72.2)	(399.6)	(444.4)	(44.8)	(11.2)
Gross Profit	608.8	790.3	181.5	29.8	1026.6	997.4	(29.2)	(2.8)
Other operating expenses ⁽¹⁾	(195.4)	(248.9)	(53.5)	(27.4)	(319.5)	(315.3)	4.2	1.3
General and administrative expenses ⁽¹⁾	(51.2)	(58.1)	(6.9)	(13.5)	(100.9)	(85.1)	15.8	15.7
Other sales and marketing expenses ⁽¹⁾	(64.4)	(80.1)	(15.7)	(24.4)	(108.9)	(102.8)	6.1	5.6
Operating income before depreciation and amortization	297.8	403.2	105.4	35.4	497.2	494.2	(3.1)	(0.6)
Depreciation and amortization ..	(176.4)	(266.3)	(89.9)	(51.0)	—	—	—	—
Goodwill impairment	—	(121.9)	(121.9)	—	—	—	—	—
Other expenses, net.....	(5.6)	(29.8)	(24.2)	(432.1)	—	—	—	—
Management fees.....	(3.1)	(6.2)	(3.1)	(100)	—	—	—	—
Restructuring and other non-recurring costs	(7.6)	(20.8)	(13.2)	(173.7)	—	—	—	—
Operating profit.....	105.1	(41.7)	(146.9)	(139.7)	—	—	—	—

Gain arising on step acquisitions	134.8	—	(134.8)	—	—	—	—	—
Share of profit of associates	11.7	—	(11.7)	—	—	—	—	—
Finance income	16.6	30.5	13.9	83.7	—	—	—	—
Finance costs	(111.6)	(204.7)	(93.1)	(83.4)	—	—	—	—
(Loss)/profit before income tax expenses	156.6	(215.8)	(372.4)	(237.9)	—	—	—	—
Income tax benefits/(expenses)	(32.5)	26.0	58.5	180.0	—	—	—	—
(Loss)/profit for the year	123.9	(189.8)	(314.1)	(253.1)	—	—	—	—

(1) Each of these items also includes staff costs and employee benefits to the extent they relate to the costs included in such line item. Beginning with the year ended December 31, 2013, such staff costs and employee benefits have been accounted for in a separate line item and reflect total Group staff costs for all functions. See the historical financial statements for the year ended December 31, 2013 elsewhere in these Listing Particulars for further details. For comparative purposes staff and employee costs were reclassified for the year ended December 31, 2012 to match the new reporting method of the Group. The table above does not reflect such reclassification.

Significant Events Affecting Historical Results

Our results of operations for the year ended December 31, 2012 were significantly impacted by the acquisition of a controlling equity interest in Cabovisão, a Portuguese telecommunications company, by Altice International in February 2012 (the results of which are consolidated in the Historical Consolidated Financial Information with effect from February 29, 2012). Cabovisão contributed €98.2 million to revenue, €20.0 million to operating loss and €29.8 million to the combined EBITDA of the Group in the year ended December 31, 2012.

In addition, in the fourth quarter of 2012, Altice International completed the take-private transaction of the HOT Group whereby it acquired substantially all of the equity interests in HOT-Telecommunication Systems Ltd. it did not previously own.

Our results of operations for the year ended December 31, 2011 were significantly impacted by the following events:

- in March 2011, Altice International increased its ownership in HOT- Telecommunication Systems Ltd. thereby acquiring a majority equity ownership in the HOT Telecom Group (as a result of which the financial information of the HOT Telecom Group is consolidated in the Historical Consolidated Financial Information with effect from March 31, 2011). In 2011, the HOT Telecom Group had €165.2 million of revenue, €30.9 million of operating loss and €63.3 million of EBITDA, which are not consolidated in the Historical Consolidated Financial Information, whereas HOT Telecom Group contributed €499.7 million to revenue, €98.4 million to operating profit and €212.4 million to EBITDA on a consolidated basis in the year ended December 31, 2011 since March 31, 2011.
- in May 2011, Altice International's subsidiary MIRS Communications Ltd. was awarded a license to provide UMTS based 3G mobile services pursuant to which it began building out its UMTS mobile network and launched 3G mobile services in May 2012, resulting in us incurring significant capital expenditures and operating costs.
- in the second quarter of 2011, Altice International acquired a controlling equity interest in Coditel Brabant S.p.r.l in Belgium and Coditel S.à r.l. in Luxembourg through an intermediate holding company, Coditel Holding S.A. (the financial information of which is consolidated in the Historical Consolidated Financial Information with effect from July 1, 2011). In 2011, Coditel Brabant S.p.r.l and Coditel S.à r.l. together had €32.3 million of revenue, €9.9 million of operating profit and €18.1 million of EBITDA, which are not consolidated in the Historical Consolidated Financial Information whereas Coditel Holding S.à r.l. contributed €34.8 million to revenue, €(1.4) million to operating profit and €20.4 million to EBITDA on a consolidated basis in the year ended December 31, 2011 since June 30, 2011.

In addition, in the fourth quarter of 2011, MIRS Communications Ltd. was acquired by the HOT Telecom Group from a subsidiary of Altice International and renamed HOT Mobile Ltd. The HOT Telecom Group and HOT Mobile Ltd. are collectively referred to herein as the "HOT Group".

Revenue

Historical Consolidated Basis

For the year ended December 31, 2012, we generated total revenue of €1,092.4 million, a 39.3% increase compared to €784.2 million for the year ended December 31, 2011. Our total revenue by our key regions in the years ended December 31, 2012 and 2011, respectively, were: (i) in Israel, €850.4 million and €680.4 million (2011 revenue was impacted by the consolidation of the HOT Telecom Group only with effect from March 2011), (ii) Belgium and

Luxembourg, €71.3 million and € 34.8 million (2011 revenue was impacted by the consolidation of Coditel Holding S.A. only with effect from July 1, 2011), (iii) in Portugal, €98.2 million and nil (the Group did not have any activities in Portugal in 2011), and (iv) in the French Overseas Territories, € 24.4 million and €23.6 million.

Cable based services: For the year ended December 31, 2012, we generated cable based services revenue of €873.3 million, a 55.9% increase compared to €560.3 million for the year ended December 31, 2011. The increase was primarily due to the inclusion of revenue from Portugal in 2012 following the acquisition of Cabovisão and the consolidation of the HOT Telecom Group and Coditel Holding S.A. for the full year in 2012 compared to only a part of the year in 2011.

Mobile services: For the year ended December 31, 2012, we generated mobile services revenue of €172.7 million, a 4.4% decrease compared to €180.6 million for the year ended December 31, 2011. This was primarily due to the decline in mobile revenue in Israel due to the factors discussed below.

B2B and others: For the year ended December 31, 2012, we generated B2B and other services revenue of €46.4 million, a 7.2% increase compared to €43.3 million for the year ended December 31, 2011. Foreign exchange translation movements between the CHF and euro had a positive impact of €1.0 million on B2B revenue.

Aggregated Basis

The following table sets forth our revenue by country of operation and on a total aggregate basis based on the Illustrative Aggregated Selected Financial Information.

	Illustrative Aggregated Selected Financial Information											
	For the year ended December 31, 2011					For the year ended December 31, 2012						
	Israel	Belgium & Luxembourg	Portugal	French Overseas Territories ⁽²⁾	Others ⁽¹⁾	Total	Israel	Belgium & Luxembourg	Portugal	French Overseas Territories ⁽²⁾	Others ⁽¹⁾	Total
	€ in millions											
Revenue												
Cable based services.....	664.9	58.5	123.4	92.0	2.4	941.2	677.9	59.7	118.0	87.8	2.4	945.7
Mobile Services.....	180.6	—	—	125.8	—	306.5	172.5	0.2	—	131.7	—	304.4
B2B and others.....	—	8.8	115.4	—	54.3	178.5	—	11.5	117.4	—	62.7	191.6
Total Revenue.....	845.5	67.3	238.8	217.9	56.7	1,426.2	850.4	71.3	235.4	219.6	65.2	1,441.8

(1) Others include our B2B telecommunications solutions business and datacenter operations in Switzerland (Green and Green Datacenter), our datacenter operations in France (Auberimmo) and our content production and distribution businesses in France and Luxembourg (Ma Chaîne Sport and SportV.) We disposed of our interests in Valvision (which was included in Others) in 2013 to the Numericable Group. Green Datacenter and Auberimmo are designated as unrestricted subsidiaries under the terms governing the indebtedness of the Group.

(2) For the French Overseas Territories, cable based services includes revenues from cable based services we provide in Guadeloupe and Martinique as well as the xDSL based broadband internet (including IPTV) and fixed-line telephony services we provide in Guadeloupe, Martinique, French Guiana, La Réunion and Mayotte.

Israel: For the year ended December 31, 2012, we generated total revenue in Israel of €850.4 million, a 0.6% increase compared to €845.5 million for the year ended December 31, 2011. As compared to the year ended December 31, 2011, for the year ended December 31, 2012 our cable based services revenue increased by approximately 2.0% and our mobile services revenue decreased by approximately 4.5%.

The increase in cable based services revenue in Israel was due to the increase in cable based services ARPU of 4.7% (4.3% at a constant exchange rate) from €42.4 for the year ended December 31, 2011 to €44.4 for the year ended December 31, 2012 primarily as a result of our strategic focus on multiple-play offerings. We experienced an increase in the number of Cable Customer Relationships subscribing for our triple-play service as a result of our attractive bundling strategy, with the number of triple-play Cable Customer Relationships increasing from approximately 348,000 as of December 31, 2011 to approximately 413,000 as of December 31, 2012. In addition, cable based services ARPU was impacted by other factors, including: (i) the introduction of, and an increase in take-up of, our higher value higher speed broadband internet infrastructure services (including 100 Mbps services which we introduced in 2010) resulting in an increase in ARPU associated with our broadband internet infrastructure access services and (ii) with respect to our fixed-line telephony services, decreased interconnect fees and call volumes which resulted in lower interconnection revenues, as subscribers reduced the number of calls placed over landlines, (as a result of strong competition from the mobile segment), which we believe is consistent with general industry-wide trends as well as the reduction in revenue as a result of the increased take-up of our unlimited fixed-line telephony offerings, resulting in a decrease in ARPU associated with our fixed-line telephony services. Our cable based ARPU was also positively impacted by the migration of customers from analog to digital pay television services, with a 38,000 net increase digital RGUs and a 33,000 net decline in analog RGUs in 2012. We intend to continue focusing on increasing ARPUs by increasing our triple-play penetration, promoting the migration of analog cable television subscribers to our digital services and launching other revenue and service enhancing measures. Our revenue was also positively impacted by a 49,000 net increase in our total cable RGUs, comprising a 5,000 net increase in pay television RGUs, a 3,000 net increase in broadband internet

infrastructure access RGUs and a 41,000 net increase in fixed-line telephony RGUs. The growth in RGUs is attributable to the success of our multiple-play offerings, our efforts to increase the attractiveness of our television channel offering, including an overall increase in HD content, VoD and PVR services and the growth in the number of subscriptions to broadband internet infrastructure access overall in Israel and our ability to offer our subscribers higher speeds and increased bandwidth capacity compared to alternative technologies such as xDSL.

The decrease in mobile services revenue in Israel was primarily due to a decrease in mobile ARPU by €6.1, or 23.9%, to €19.4 for the year ended December 31, 2012 compared to €25.5 for the year ended December 31, 2011. This decrease in mobile ARPU was mainly due to the combined effects of a decrease in interconnection revenues and subscribers disconnecting from our higher ARPU iDEN mobile network as a result of decreased marketing and the termination in the third quarter of 2012 of our contract with the Israeli Defense Force, which was offset by an increase in our lower ARPU UMTS based network subscribers following the launch of 3G services in May 2012. Consequently, ARPU from gross-adds to our mobile RGUs were generally lower than the ARPU for customers churned. As of December 31, 2012 we had 766,000 total mobile RGUs in Israel comprising 325,000 iDEN customers and 441,000 UMTS customers compared to 444,000 mobile customers (all iDEN based) as of December 31, 2011. Revenue and mobile ARPU were also negatively impacted by price pressure for mobile services, in particular for our UMTS based 3G services.

Belgium and Luxembourg: For the year ended December 31, 2012, we generated total revenue in Belgium and Luxembourg of €71.3 million, a 5.9% increase compared to €67.3 million for the year ended December 31, 2011. As compared to the year ended December 31, 2011, for the year ended December 31, 2012 our cable based services revenue increased by approximately 2.1% and our B2B and other services revenue increased by approximately 30.7%. In addition, we launched mobile services in Belgium in September 2012 and generated €0.2 million in mobile services revenue in the year ended December 31, 2012.

The increase in cable based services in Belgium and Luxembourg was primarily due to an increase in cable based ARPU by €2.8, or 7.6%, to €39.5 for the year ended December 31, 2012 compared to €36.7 for the year ended December 31, 2011. The increase in cable based services ARPU was due to price increases in our triple-play packages as well as stand alone pay television offerings, but was partially offset by an increased uptake of Coditel's flat rate fixed-line telephony offers. Cable based services revenue was also positively impacted by an approximately 1,000 net increase in the number of television RGUs due in part to our acquisition of a concession from the AIESH, a Belgian municipality, in the fourth quarter of 2012, to provide pay television services to existing analog customers served by the AIESH network and to upgrade the AIESH network. As of December 31, 2012, the AIESH concession represented approximately 12,400 Cable Customer Relationships. The AIESH concession is for a period of 30 years and can be extended for a further period of 20 years. We have upgraded the entire AIESH network and converted the analog customers served by the upgraded AIESH network into digital customers. This was partially offset by an approximately 2,000 net decrease in the number of digital television RGUs primarily due to competition, particularly from IPTV offers by Belgacom in Brussels and POST in Luxembourg. Cable based services revenue was also positively impacted by an increase in broadband internet RGUs which was primarily due to our ability to offer subscribers higher speeds and increased bandwidth capacity compared to providers relying on alternative technologies such as xDSL and mobile broadband networks, our attractive pricing of broadband internet services and due to increase in uptake of our triple-play bundles, which includes broadband internet services.

The increase in B2B and other revenue in Belgium and Luxembourg was primarily due to higher installation fees earned from our project for the Brussels police involving installation of fiber links for the CCTV network, a portion of which reflects non-recurring revenues.

Portugal: For the year ended December 31, 2012, we generated total revenue in Portugal of €235.4 million, a 1.4% decrease compared to €238.8 million for the year ended December 31, 2011. As compared to the year ended December 31, 2011, for the year ended December 31, 2012 our revenue in Portugal for our cable based services decreased by approximately 4.4% and our B2B and other services revenue increased by 1.7%.

The decrease in cable based services revenue in Portugal was primarily driven by a net decrease in total number of cable RGUs by approximately 21,000, comprising of a net decrease of approximately 11,000 pay television RGUs and approximately 3,000 broadband internet RGUs. These were the result of intense competition in the Portuguese cable services market during 2012, with aggressive promotions and pricing policies adopted by competitors and their increased focus on competing multiple-play offerings, as well as the adverse economic conditions and austerity measures in Portugal which had a negative effect on consumer confidence pushing them to opt for cheaper packages. Our strategic decision during the course of 2012 to cease offering certain aggressively priced packages and to migrate customers to triple-play offerings also contributed to the decline in cable RGUs. Although there was a net reduction of approximately 8,000 fixed-line telephony RGUs in the twelve months ended December 31, 2012, the average fixed-line telephony RGUs for the twelve months ended December 31, 2012 was higher compared to the twelve months ended December 31, 2011, which partially offset a decline in cable based services revenue in 2012. A decrease in cable based services ARPU by €2.0, or 5.4%, to €34.9 for the twelve months ended December 31, 2012 compared to €36.9 for the twelve months

ended December 31, 2011 also contributed to the decrease in the cable based services revenue. In 2012, our cable based services ARPU was negatively impacted by aggressive competition in each segment of the cable services market which required us to offer discounts and undertake other promotional offers. As a result, the ARPU from gross-adds to our RGUs were generally lower than the ARPU for customers churned. We nevertheless took the strategic decision during the course of 2012 to cease offering certain aggressively priced packages to reduce the decrease of ARPU, which has resulted in an increase in ARPU towards the end of 2012. We have implemented certain measures which are aimed at improving our competitive position in future periods, including improvements to our website which will enable customers to directly subscribe for our products online, rolling out additional stores and entering into arrangements with distributors (primarily supermarkets). There can however be no assurance that these measures will be successful in achieving RGU or ARPU growth in future periods.

The increase in B2B and other revenue in Portugal was primarily due to the higher level of business with carriers (transit) and sales of equipment that occurred in 2012, linked to certain specific projects undertaken by ONI.

French Overseas Territories: For the year ended December 31, 2012, we generated total revenue in the French Overseas Territories of €219.6 million, a 0.8% increase compared to €217.9 million for the year ended December 31, 2011. As compared to the year ended December 31, 2011, for the year ended December 31, 2012 our revenue in the French Overseas Territories for our fixed-line services decreased by 4.6% and our mobile services revenue increased by 4.7%.

The decrease in fixed-line services revenue in the French Overseas Territories was primarily due to a decrease in fixed-line revenue of Outremer prior to its acquisition by the Group, which in turn was mainly as a result of a net decrease of approximately 6,000 fixed-line telephony RGUs due to continuation in the trend of customers switching from traditional voice telephony towards multiple-play VoIP packages. Revenue associated with Outremer's broadband internet services (including IPTV) remained relatively stable during the period, which was influenced by increased competition, particularly in the Indian Ocean region comprising La Reunion and Mayotte, and the limited ability and marketing investment to provide triple-play services prior to the integration of Outremer in the Group. The decrease in fixed-line revenue of Outremer, was partially offset by the increase in revenue from Le Cable, the Group's cable business in the French Overseas Territories of Guadeloupe and Martinique, primarily due to an increase in cable based services ARPU by €5.2, or 12.1%, to €48.3 for the twelve months ended December 31, 2012 compared to €43.1 for the twelve months ended December 31, 2011. This ARPU growth was primarily due to migration of standalone pay television customers to triple-play packages as a result of our strategic focus on triple-play offerings, migration of customer from analog to digital services and an increase in uptake of VoD services, as well as price increases for our cable based services. RGU growth for our cable based services by approximately 4,000 RGUs net, which was driven by an increase in triple-play penetration also contributed to the increase in cable based services revenue.

The increase in mobile services revenue in the French Overseas Territories, all of which is attributable to Outremer, was primarily due to net increase of 30,000 mobile subscribers over the period. This increase was a result of the revamping of Outremer's mobile post-paid offering, particularly due to the success of flat-fee rate plans with unlimited calls towards the French Overseas Territories and mainland France, which Outremer introduced in the first half of 2012. This increase was offset by a decrease in mobile ARPUs by €2.2, or 7.6%, to €26.7 for the year ended December 31, 2012 compared to €28.9 for the year ended December 31, 2011. This decrease in mobile ARPU during the year ended December 31, 2012 was mainly due to sharply lower mobile interconnection rates prescribed by the French national regulatory authority for electronic communications, the ARCEP, in 2012 compared to 2011, which was partially offset by the improvement in product mix with greater demand for Outremer's higher value post-paid packages following the revamping of its mobile product offering in the first half of 2012. We expect overall mobile ARPU to further decrease in future periods due to price pressure in mobile services.

Gross Profit

Historical Consolidated Basis

For the year ended December 31, 2012, our total gross profit was €790.3 million, a 29.8% increase compared to €608.8 million for the year ended December 31, 2011. Our gross profit by our key regions in the years ended December 31, 2012 and 2011, respectively, were: (i) in Israel, €621.7 million and €535.3 million (2011 gross profit was impacted by the consolidation of the HOT Telecom Group only with effect from March 2011), (ii) Belgium and Luxembourg, €60.3 million and €27.5 million (2011 gross profit was impacted by the consolidation of Coditel Holding S.A. only with effect from July 1, 2011), (iii) in Portugal, €59.1 million and nil (the Group did not have any activities in Portugal in 2011), and (iv) in the French Overseas Territories, €20.4 million and €19.8 million. Our gross margin decreased from 77.6% in the year ended December 31, 2011 to 72.3% in the year ended December 31, 2012.

Cable based services: For the year ended December 31, 2012, our gross profit from our cable based services was €660.4 million, a 51.8% increase compared to €435.0 million for the year ended December 31, 2011. The increase was primarily due to the inclusion of gross profit from Portugal in 2012 following the acquisition of Cabovisão and the

consolidation of the HOT Telecom Group and Coditel Holding S.A. for the full year in 2012 compared to only a part of the year in 2011. Our gross margin for cable based services decreased from 77.6% in the year ended December 31, 2011 to 75.6% in the year ended December 31, 2012.

Mobile services: For the year ended December 31, 2012, our gross profit from our mobile services was €102.8 million, a 31.3% decrease compared to €149.7 million for the year ended December 31, 2011. This was primarily due to the increase in purchasing and subcontracting services for mobile revenue in Israel due to the factors discussed below. Our gross margin for mobile services decreased from 82.9% in the year ended December 31, 2011 to 59.5% in the year ended December 31, 2012.

B2B and others: For the year ended December 31, 2012, our gross profit from B2B and others was €27.1 million, an 12.4% increase compared to €24.1 million for the year ended December 31, 2011. Our gross margin for B2B and other services increased from 55.7% in the year ended December 31, 2011 to 58.4% in the year ended December 31, 2012.

Aggregated Basis

The following table sets forth our purchasing and subcontracting services by country of operation and on a total aggregate basis based on the Illustrative Aggregated Selected Financial Information.

	Illustrative Aggregated Selected Financial Information											
	For the year ended December 31, 2011					For the year ended December 31, 2012						
	Israel	Belgium & Luxembourg	Portugal	French Overseas Territories ⁽²⁾	Others ⁽¹⁾	Total	Israel	Belgium & Luxembourg	Portugal	French Overseas Territories ⁽²⁾	Others ⁽¹⁾	Total
	€ in millions											
Purchasing and subcontracting services												
Cable based services.....	154.3	11.6	54.7	27.6	0.5	248.8	159.0	10.0	47.9	26.5	0.5	243.9
Mobile Services.....	31.0	—	—	40.8	—	71.8	69.8	0.1	—	41.5	—	111.4
B2B and others.....	—	1.0	58.8	—	19.2	79.0	—	0.8	66.8	—	21.5	89.2
Total Purchasing and subcontracting services.....	185.3	12.6	113.5	68.4	19.7	399.6	228.8	11.0	114.7	68.0	22.0	444.5

(1) Others include our B2B telecommunications solutions business and datacenter operations in Switzerland (Green and Green Datacenter), our datacenter operations in France (Auberimmo) and our content production and distribution businesses in France and Luxembourg (Ma Chaîne Sport and SportV.) We disposed of our interests in Valvision (which was included in Others) in 2013 to the Numericable Group. Green Datacenter and Auberimmo are designated as unrestricted subsidiaries under the terms governing the indebtedness of the Group.

(2) For the French Overseas Territories, cable based services includes purchasing and subcontracting services for cable based services we provide in Guadeloupe and Martinique as well as the xDSL based broadband internet (including IPTV) and fixed-line telephony services we provide in Guadeloupe, Martinique, French Guiana, La Réunion and Mayotte.

Israel: For the year ended December 31, 2012, our purchasing and subcontracting services in Israel were €228.8 million, a 23.5% increase compared to €185.3 million for the year ended December 31, 2011. As compared to the year ended December 31, 2011, for the year ended December 31, 2012 our purchasing and subcontracting services costs for cable based services decreased by approximately 3.0% and our purchasing and subcontracting services costs for mobile services increased by approximately 125.2%.

The increase in purchasing and subcontracting services for cable based services in Israel was primarily due to an increase in interconnection fees paid as a result of higher call volumes by our customers due to the increased take-up of our unlimited fixed-line calls package offered as a component of our multiple-play offers.

The increase in purchasing and subcontracting services for mobile services in Israel was primarily due to the launch of UMTS based 3G mobile services in 2012, including interconnection fees of €43.6 million we incurred with respect to our 3G mobile services and increased costs in respect of offering compatible mobile handsets. Interconnection fees in 2012 included national roaming costs of €21.4 million.

Belgium and Luxembourg: For the year ended December 31, 2012, our purchasing and subcontracting services in Belgium and Luxembourg was €11.0 million, a 13.2% decrease compared to €12.6 million for the year ended December 31, 2011. As compared to the year ended December 31, 2011, for the year ended December 31, 2012 our purchasing and subcontracting services for cable based services decreased by approximately 13.9% and our purchasing and subcontracting services for B2B services decreased by approximately 14.8%. We began providing mobile services in Belgium in September 2012 as an MVNO and incurred minor purchasing and subcontracting services in an amount of approximately €0.1 million in the year ended December 31, 2012.

The decrease in purchasing and subcontracting services for cable based services in Belgium and Luxembourg was primarily due to a reduction in VoIP costs following the renegotiating of contracts and change of supplier, lower data

interconnection costs and slightly lower VoD costs, which were partially offset by an increase in amounts paid to television channels due to the addition of more expensive premium channels in Coditel's television packages.

The decrease in purchasing and subcontracting services for B2B services in Belgium and Luxembourg was due to optimization of costs relating to our B2B business, including costs of external service providers, as well as due to the nature of the B2B projects undertaken in 2012, for which the costs were primarily in the form of capital expenditures.

Portugal: For the year ended December 31, 2012, our purchasing and subcontracting services in Portugal were €114.7 million, a 1.0% increase compared to €113.5 million for the year ended December 31, 2011. As compared to the year ended December 31, 2011, for the year ended December 31, 2012 our purchasing and subcontracting services for cable based services decreased by approximately 12.4% and our purchasing and subcontracting services for B2B and others increased by approximately 13.6%.

The decrease in purchasing and subcontracting services for cable based services in Portugal was primarily a result of an operational optimization program implemented by the Group following the acquisition of Cabovisão in February 2012, which included savings through renegotiations of television content rights.

The increase in costs of sales for B2B and others in Portugal was due to the increase in the level of ONI's business with carriers (transit) and sales of equipment in 2012, which are projects that inherently have a lower gross profit margin.

French Overseas Territories: For the year ended December 31, 2012, our purchasing and subcontracting services in the French Overseas Territories was €68.0 million, a 0.6% decrease compared to €68.4 million for the year ended December 31, 2011. As compared to the year ended December 31, 2011, for the year ended December 31, 2012 our purchasing and subcontracting services for cable based services decreased by approximately 4.0% and our purchasing and subcontracting services for mobile services increased by approximately 1.8%.

The decrease in purchasing and subcontracting services for fixed-line services in the French Overseas Territories was primarily due to savings arising through renegotiations of television content rights and interconnection contracts in connection with Le Cable's cable based services.

The increase in costs of sales for mobile services in the French Overseas Territories was mainly due to the increase in interconnections costs with the success of the flat-fee rate plans including unlimited calls introduced by Outremer, which was partially offset by the sharp decrease in mobile termination rates in 2012.

As a result of the factors described above, our gross profit and gross margin by country of operation on a total aggregate basis based on the Illustrative Aggregated Selected Financial Information was as follows:

	Illustrative Aggregated Selected Financial Information											
	For the year ended December 31, 2011					For the year ended December 31, 2012						
	Israel	Belgium & Luxembourg	Portugal	French Overseas Territories ⁽²⁾	Others ⁽¹⁾	Total	Israel	Belgium & Luxembourg	Portugal	French Overseas Territories ⁽²⁾	Others ⁽¹⁾	Total
	€ in millions											
Gross profit												
Cable based services.....	510.5	46.8	68.7	64.4	1.9	692.4	518.9	49.6	70.1	61.3	1.9	701.9
Mobile Services.....	149.7	—	—	85.1	—	234.7	102.7	0.1	—	90.2	—	193.0
B2B and others.....	—	7.8	56.6	—	35.1	99.5	—	10.6	50.6	—	41.2	102.4
Total gross profit.....	660.2	54.7	125.3	149.5	36.9	1,026.6	621.7	60.3	120.7	151.5	43.1	997.4

	Illustrative Aggregated Selected Financial Information											
	For the year ended December 31, 2011					For the year ended December 31, 2012						
	Israel	Belgium & Luxembourg	Portugal	French Overseas Territories ⁽²⁾	Others ⁽¹⁾	Total	Israel	Belgium & Luxembourg	Portugal	French Overseas Territories ⁽²⁾	Others ⁽¹⁾	Total
	€ in millions											
Gross margin												
Cable based services (%).....	76.8	80.1	55.7	70.0	77.3	73.6	76.6	83.3	59.4	69.8	79.5	74.2
Mobile Services (%).....	82.9	—	—	67.6	—	76.6	59.5	41.5	—	68.5	—	63.4
B2B and others (%).....	—	88.9	49.0	—	64.6	55.7	—	92.7	43.1	—	65.7	53.5
Total gross margin (%).....	78.1	81.2	52.5	68.6	65.2	72.0	73.1	84.6	51.3	69.0	66.2	69.2

(1) Others include our B2B telecommunications solutions business and datacenter operations in Switzerland (Green and Green Datacenter), our datacenter operations in France (Auberimmo) and our content production and distribution businesses in France and Luxembourg (Ma Chaîne Sport and SportV.) We disposed of our interests in Valvision (which was included in Others) in 2013 to the Numericable Group. Green Datacenter and Auberimmo are designated as unrestricted subsidiaries under the terms governing the indebtedness of the Group.

(2) For the French Overseas Territories, cable based services includes gross profit and gross margin for cable based services we provide in Guadeloupe and Martinique as well as the xDSL based broadband internet (including IPTV) and fixed-line telephony services we provide in Guadeloupe, Martinique, French Guiana, La Réunion and Mayotte.

Foreign exchange translation movements between the NIS and euro had a positive impact of €4.0 million on total gross profit in Israel.

Operating Expenses and EBITDA

Historical Consolidated Basis

For the year ended December 31, 2012, our total operating expenses were €387.1 million, a 24.5% increase compared to €311.0 million for the year ended December 31, 2011. Our total operating expenses (other than purchasing and subcontracting services) comprise of other operating expenses, which increased by 27.4%, general and administrative expenses, which increased by 13.5% and other sales and marketing expenses, which increased by 24.4%, in each case in the year ended December 31, 2012 compared to the year ended December 31, 2011.

Our total operating expenses by our key regions in the years ended December 31, 2012 and 2011, respectively, were: (i) in Israel, € 316.5 million and €279.2 million (2011 operating expenses were impacted by the consolidation of the HOT Telecom Group only with effect from March 2011), (ii) Belgium and Luxembourg, €14.7 million and € 7.0 million (2011 operating expenses were impacted by the consolidation of Coditel Holding S.A. only with effect from July 1, 2011), (iii) in Portugal, €29.2 million and nil (the Group did not have any activities in Portugal in 2011), and (iv) in the French Overseas Territories, €8.3 million and €8.1 million.

We define EBITDA in our Historical Consolidated Financial Statements as operating profit before depreciation and amortization, goodwill impairment, other expenses, net, management fees and restructuring and other non-recurring costs. As a result, for the year ended December 31, 2012, our EBITDA was €403.2 million, a 35.4% increase compared to € 297.8 million for the year ended December 31, 2011. Our EBITDA by our key regions in the years ended December 31, 2012 and 2011, respectively, were: (i) in Israel, €305.2 million and €256.1 million, (ii) Belgium and Luxembourg, €45.6 million and €20.4 million, (iii) in Portugal, €29.8 million and nil, and (iv) in the French Overseas Territories, €12.1 million and €11.7 million. Our EBITDA margin for the year ended December 31, 2012 was 36.9% compared to 38.0% for the year ended December 31, 2011.

Aggregated Basis

For the year ended December 31, 2012, our total operating expenses on a total aggregate basis based on the Illustrative Aggregated Selected Financial Information were €503.1 million, a 4.9% decrease compared to € 529.3 million for the year ended December 31, 2011.

Israel: For the year ended December 31, 2012, our total operating expenses in Israel were €316.5 million, a 5.0% decrease compared to €333.0 million for the year ended December 31, 2011.

Other operating expenses: As compared to the year ended December 31, 2011, for the year ended December 31, 2012 our other operating expenses in Israel decreased by approximately 1.1% from €225.8 million to € 223.4 million. This decrease was primarily due to a decrease in salaries and social benefits because of a reduction in head count in customer services personnel which was partially offset by increased costs relating to the build-out of our UMTS network, maintenance on our iDEN network, launch of ISP services and the inability to capitalize certain subscriber acquisition costs due to a change in regulation prohibiting the imposition of exit fees on customers except in limited circumstances, which necessitated an implementation of commitment free contracts.

General and administrative expenses: As compared to the year ended December 31, 2011, for the year ended December 31, 2012 our general and administrative expenses in Israel decreased by approximately 26.2% from € 39.7 million to €29.3 million. This decrease was primarily as a result of a decrease in salary and social benefits expenses because of a reduction in head count in administrative personnel.

Other sales and marketing expenses: As compared to the year ended December 31, 2011, for the year ended December 31, 2012 our other sales and marketing expenses in Israel decreased by approximately 5.5% from € 67.5 million to €63.7 million. This decrease was primarily due to decreased sales commissions to retailers, advertising costs and sales promotions. This was partially offset by increased salary expense as a result of the inability to capitalize commissions and salaries of sales personnel as compared to the prior year period due to a change in regulation prohibiting the imposition of exit fees on customers except in limited circumstances, which necessitated an implementation of commitment free contracts.

EBITDA: As a result of the factors discussed, for the year ended December 31, 2012, in Israel our EBITDA was €305.2 million, a 6.7% decrease compared to €327.2 million for the year ended December 31, 2011 and our EBITDA margin was 35.9% in December 31, 2012 compared to 38.7% in the year ended December 31, 2011. Foreign exchange translation movements between the NIS and euro had a positive impact of €1.2 million on total EBITDA.

Belgium and Luxembourg: For the year ended December 31, 2012, our total operating expenses in Belgium and Luxembourg were €14.7 million, a 7.4% increase compared to €13.7 million for the year ended December 31, 2011.

Other operating expenses: As compared to the year ended December 31, 2011, for the year ended December 31, 2012 our other operating expenses in Belgium and Luxembourg decreased by approximately 3.2% from €6.4 million to €6.2 million mainly explained by a decrease in technical and maintenance costs following renegotiation of maintenance contracts and a decrease in personnel costs of €0.1 million due to a slight reduction in staffing.

General and administrative expenses: As compared to the year ended December 31, 2011, for the year ended December 31, 2012 our general and administrative expenses in Belgium and Luxembourg increased marginally from €3.9 million to €4.1 million.

Other sales and marketing expenses: As compared to the year ended December 31, 2011, for the year ended December 31, 2012 our other sales and marketing expenses in Belgium and Luxembourg increased by approximately 29.6% from €3.4 million to €4.4 million. This increase was primarily due to the sales and marketing expenses associated with the launch of mobile services in Belgium in September 2012.

EBITDA: As a result of the factors discussed, for the year ended December 31, 2012, our EBITDA in Belgium and Luxembourg was €45.6 million, a 11.3% increase compared to €41.0 million for the year ended December 31, 2011. Our EBITDA margin was 64.0% in the year ended December 31, 2012 compared to 60.9% in the year ended December 31, 2011.

Portugal: For the year ended December 31, 2012, our total operating expenses in Portugal were €72.7 million, a 15.7% decrease compared to €86.3 million for the year ended December 31, 2011. This decrease was a direct result of an operational optimization program implemented by the Group following the acquisition of Cabovisão in February 2012, which was partially offset by the increase in operating expenditures relating to ONI's B2B business in Portugal as discussed below.

Other operating expenses: As compared to the year ended December 31, 2011, for the year ended December 31, 2012 our other operating expenses in Portugal decreased by approximately 8.2% from €41.7 million to €38.3 million. This decrease was primarily due to savings at Cabovisão resulting from the renegotiation of information technology maintenance and support contracts as well as headcount reductions.

General and administrative expenses: As compared to the year ended December 31, 2011, for the year ended December 31, 2012 our general and administrative expenses in Portugal decreased by approximately 24.4% from €28.8 million to €21.8 million. This decrease was primarily due to savings from head count reductions in corporate and administrative staff and savings through cancelation and renegotiation of certain contracts for administrative services, in each case relating to Cabovisão.

Other sales and marketing expenses: As compared to the year ended December 31, 2011, for the year ended December 31, 2012 our other sales and marketing expenses in Portugal decreased by approximately 19.5% from €15.7 million to €12.6 million. This decrease was mainly due to the cancelation and renegotiation of certain marketing and advertising contracts and headcount reduction in sales personnel, in each case relating to Cabovisão.

EBITDA: As a result of the factors discussed, for the year ended December 31, 2012, our EBITDA in Portugal was €47.9 million, a 22.8% increase compared to €39.0 million for the year ended December 31, 2011. Our EBITDA margin was 16.3% in the year ended December 31, 2011 compared to 20.4% in the year ended December 31, 2012.

French Overseas Territories: For the year ended December 31, 2012, our total operating expenses in the French Overseas Territories were €76.4 million, a 0.9% decrease compared to €77.1 million for the year ended December 31, 2011.

Other operating expenses: As compared to the year ended December 31, 2011, for the year ended December 31, 2012 our other operating expenses in the French Overseas Territories increased by approximately 3.5% from €43.5 million to €45.1 million. This increase was primarily due to measures taken by Outremer to improve its quality of service, in particular through densification of mobile networks and enhancement of the existing loyalty program which was partially offset by certain measures taken to optimize fixed costs, including to reduce payroll (in particular through reallocation of certain customer care staff from local centers in the French Overseas Territories to an offshoring center in Mauritius).

General and administrative expenses: As compared to the year ended December 31, 2011, for the year ended December 31, 2012 our general and administrative expenses in the French Overseas Territories decreased by approximately 12.5% from €13.6 million to €11.9 million.

Other sales and marketing expenses: As compared to the year ended December 31, 2011, for the year ended December 31, 2012 our other sales and marketing expenses in the French Overseas Territories decreased by approximately 2.7% from €20.0 million to €19.5 million. This was principally due to the decrease of external sales

(mainly door to door sellers for xDSL offerings), which was partially offset by increased marketing costs associated with the comprehensive revamping of Outremer's mobile service portfolio in 2012, including the launch of flat-fee rate plans with unlimited calls towards the French Overseas Territories and mainland France.

EBITDA: As a result of the factors discussed, for the year ended December 31, 2012, our EBITDA in the French Overseas Territories was € 75.1 million, a 3.7% increase compared to €72.4 million for the year ended December 31, 2011. Our EBITDA margin was 34.2% in the year ended December 31, 2012 compared to 33.2% in the year ended December 31, 2011.

The following tables set forth our EBITDA across our segments on an aggregated basis for the years ended December 31, 2011 and 2012.

	Illustrative Aggregated Selected Financial Information											
	For the year ended December 31, 2011						For the year ended December 31, 2012					
	Israel ⁽³⁾	Belgium & Luxembourg	Portugal	French Overseas Territories	Others ⁽²⁾	Total	Israel ⁽³⁾	Belgium & Luxembourg	Portugal	French Overseas Territories	Others ⁽²⁾	Total
EBITDA ⁽¹⁾	327.2	41.0	39.0	72.4	17.7	497.2	305.2	45.6	48.0	75.1	20.3	494.2

- (1) The Group defines EBITDA as operating profit before depreciation and amortization, goodwill impairment, other expenses, net, management fees and restructuring and other non-recurring costs.
- (2) Comprises (i) €8.1 million and €9.8 million of EBITDA generated by our content production and distribution businesses for the twelve months ended December 31, 2011 and 2012, respectively, (ii) €13.4 million and €15.5 million of EBITDA generated by Green Datacenter/Green for the year ended December 31, 2011 and 2012 and (iii) €3.8 million and €5.0 million of negative EBITDA generated by our other holding entities (including corporate expenses) of for the year ended December 31, 2011 and 2012, respectively.
- (3) In Israel, costs relating to the purchase of exclusive third party content have only been capitalized with effect from April 1, 2013.

	Illustrative Aggregated Selected Financial Information		
	For the year ended December 31,		
	2011	2012	
	€ in millions		
EBITDA	497.2	494.2	
Equity based compensation ⁽¹⁾	6.0	3.8	
Adjusted EBITDA	503.2	498.0	

- (1) Equity-based compensation consists of expenses pertaining to employee stock options provided to employees in Israel for the year ended December 31, 2011 and 2012, respectively.

Depreciation and amortization

Historical Consolidated Basis

For the year ended December 31, 2012, depreciation and amortization totaled €266.3 million, a 51.0% increase compared to €176.4 million for the year ended December 31, 2011. These were impacted by the factors listed under “—Discussion and Analysis of our Results of Operations—Year Ended December 31, 2012 compared to the Year Ended December 31, 2011—Significant Events Affecting Historical Results”. Depreciation and amortization in the year ended December 31, 2012 was impacted by the following events:

In May 2011, prior to its acquisition by the Group, Cabovisão recorded an impairment loss relating to its principal tangible fixed assets (its cable network), amounting to approximately €141.7 million and at the same time it stopped recording depreciation on the amount of such impaired assets. During Cabovisão's financial year ended August 31, 2012, following its acquisition by the Group, the impairment charge was reviewed and it was concluded that there was not sufficient rationale for the impairment charge. Accordingly, the impairment charge was reversed in its entirety and such amount, reduced by depreciation associated with the impaired assets for the last three months of the financial year ended August 31, 2011, was directly recorded in retained earnings of Cabovisão for the financial year ended August 31, 2012 (and accordingly did not have any impact on Cabovisão's income statement for the twelve month period ended December 31, 2012). Depreciation for the twelve months ended December 31, 2011 however includes €11.6 million of depreciation expenses related to the catch-up of depreciation on the relevant assets for the period from September 1, 2011 to December 31, 2011 (corresponding to the first four months of financial year ended August 31, 2012). Depreciation for the twelve months ended December 31, 2011 includes approximately € 141.7 million relating to the impairment charge. These events did not have an impact on the financial results of Altice International in the periods under review.

Goodwill impairment

In 2012, Cool Holding a subsidiary of Altice International and the holding company of HOT, recorded an impairment charge of approximately NIS 604 million (€121.9 million equivalent) as a result of a valuation by Cool Holding, with the assistance of an external appraiser, pursuant to which Cool Holding concluded that the recoverable amount of the in-country fixed line communication segment was lower than its carrying amount. There was no goodwill impairment recorded in 2011.

Operating Profit

Historical Consolidated Basis

For the year ended December 31, 2012, (i) other expenses, net totaled €29.8 million, a 432.1% increase compared to €5.6 million for the year ended December 31, 2011; (ii) management fees primarily relating to consulting services totaled €6.2 million compared to €3.1 million for the year ended December 31, 2011 and (iii) restructuring and other non-recurring costs totaled €20.8 million compared to a restructuring and other non-recurring costs of €7.6 million for the year ended December 31, 2011. As a result, for the year ended December 31, 2012, our operating loss was €41.7 million, compared to an operating profit of €105.1 million for the year ended December 31, 2011.

Gains arising on step acquisition

Gain arising on step acquisitions was nil in the year ended December 31, 2012 compared to €134.8 million for the year ended December 31, 2011, which was primarily due to a non-recurring income of €133.0 million recognized in the year ended December 31, 2011 owing to the acquisition of a controlling stake in HOT and the subsequent change in accounting via the consolidation method from equity method as a result of which the equity stake held in HOT prior to the change in control was re-evaluated at its fair value on the date of the change in control.

Share of profit of associates

For the year ended December 31, 2012 our share of profit of associates was nil compared to €11.7 million for the year ended December 31, 2011 representing share of profit from HOT prior to the acquisition of controlling interest in March 2011.

Finance costs (net)

For the year ended December 31, 2012, our net finance costs totaled €174.2million, a 83.4% increase compared to €95.0 million for the year ended December 31, 2011 which was primarily due to full year impact of higher debt levels of the Group mainly due to the debt incurred by the Group to finance the Group's investments in HOT and Coditel in 2011.

Income tax benefits/(expenses)

For the year ended December 31, 2012, our total income tax benefit was €26.0 million compared to an income tax expense of €32.5 million for the year ended December 31, 2011 which was primarily due to higher profit before taxes in the year ended

December 31, 2011 as a result of the factors described above and in particular, the non-recurring income of €133.0 million recognized in the year ended December 31, 2011 owing to the acquisition of a controlling stake in HOT Telecom and the subsequent change in accounting via the consolidation method from equity method.

Profit for the year

As a result of the factors discussed above, for the year ended December 31, 2012, our loss for the year was €189.8 million compared to a profit of €123.9 million for the year ended December 31, 2011.

Liquidity and Capital Resources

Cash and Debt Profile

As of September 30, 2014, our consolidated cash and cash equivalents amounted to €141.1 million on an actual basis. Each of our operating subsidiaries maintains cash and cash equivalents to fund their day-to-day requirements.

Our most significant financial obligations are our debt obligations. As a result of the various acquisitions we have made since 2010 and the financing transactions that we entered into to fund such acquisitions, our financing profile has undergone a substantial change in this period. In particular, in December 2012, June 2013 and December 2013 we entered into significant financing transactions, among other things, to finance investments in certain of our subsidiaries and to refinance certain existing indebtedness. Our total debt as of September 30, 2014 was €3,730 million, in each case including finance leases (which amounted €22 million) but excluding other long term and short term liabilities. In addition the Senior Secured Notes Issuer will be able to draw up to \$80 million under the 2012 Revolving Credit Facility and €80 million under the 2013 Revolving Credit Facility (all of which has been drawn as of September 30, 2014), up to €330 million under the New Super Senior Revolving Credit Facility (of which it is expected that €180 million will be drawn to complete the PT Portugal Acquisition), up to €501 million under the New Pari Passu Revolving Credit Facility and up to €15 million under the 2013 Guarantee Facility (of which as of the date hereof, the Senior Secured Notes Issuer has made one request for a guarantee of approximately €6.8 million which represents a contingent liability of the Group). In addition, in connection with the New Transactions, we expect to issue the Notes offered hereby and enter into the New Term Loan.

Our material indebtedness (excluding the Existing Revolving Credit Facility Agreements, the New Revolving Credit Facilities, the 2013 Guarantee Facility and finance leases and other long term and short term liabilities) and principal repayment obligations, giving effect to the New Transactions but without giving effect to any hedging transaction and excluding accrued interest and debt issuance costs, with respect to such indebtedness are set forth below. The terms of our debt instruments contain certain restrictions, including covenants that restrict our ability to incur additional debt. As a result, additional debt financing is only a potential source of liquidity if the incurrence of any new debt is permitted by the terms of our existing debt instruments. See “Description of Other Indebtedness”.

	Period ending December 31,				
	2014	2015	2016	2017 or later	Total
	€ in millions				
Existing HOT Unsecured Notes ⁽¹⁾	0	27	27	202	255
Green Datacenter Debt.....	0	0	0	35	35
2012 Senior Secured Notes ⁽²⁾	0	0	0	574	574
2013 Term Loan.....	2	8	8	794	813
2012 Senior Notes ⁽²⁾	0	0	0	337	337
2013 June Senior Notes.....	0	0	0	250	250
2013 December Senior Notes ⁽²⁾	0	0	0	317	317
2013 December Senior Secured Notes ⁽²⁾	0	0	0	1,013	1,013
Notes offered hereby.....	0	0	0	2,656	2,656
New Term Loan.....	0	0	8	833	841
New Super Senior Revolving Credit Facility Drawn.....	0	0	0	180	180
Existing Revolving Credit Facility Agreements Drawn.....		124		0	124
Total	2	159	43	7,190	7,395

(1) The amount is based on the exchange rate as of September 30, 2014 of €0.215 = NIS 1.00.

(2) The amount is based on the exchange rates as of September 30, 2014 of €0.7918 = \$1.00.

Sources of Liquidity

Our principal source of liquidity is expected to be the operating cash flows of our operating subsidiaries and if required borrowings under the Existing Revolving Credit Facility Agreements and €15 million under the 2013 Guarantee Facility. We will be able to draw up to \$80 million under the 2012 Revolving Credit Facility, up to €80 million under the 2013 Revolving Credit Facility (all of which has been drawn as of September 30, 2014) and up to €15 million under the 2013 Guarantee Facility (of which one request for a guarantee of approximately €6.8 million as of the date hereof). In addition, we expect to be able to draw €330 million under the New Super Senior Revolving Credit Facility (of which it is expected that €180 million will be drawn to complete the PT Portugal Acquisition) and up to €501 million under the New Pari Passu Revolving Credit Facility.

We expect to use these sources of liquidity to fund operating expenses, working capital requirements, capital expenditures, debt service requirements and other liquidity requirements that may arise from time to time. Our ability to generate cash from our operations will depend on our future operating performance, which is in turn dependent, to some extent, on general economic, financial, competitive, market, regulatory and other factors, many of which are beyond our control. We believe that our cash and cash equivalents, the cash provided from the operations of our operating subsidiaries and any available borrowings under the Existing Revolving Credit Facility Agreements, the 2013 Guarantee Facility, the New Super Senior Revolving Credit Facility and the New Pari Passu Revolving Credit Facility will be sufficient to fund our currently anticipated working capital needs, capital expenditures, and debt service requirements

during the next 12 months, although no assurance can be given that this will be the case. However, as our debt matures in later years, we anticipate that we will seek to refinance or otherwise extend our debt maturities. No assurance can be given that we will be able to complete refinancing transactions or otherwise extend our debt maturities. In this regard, it is not possible to predict how economic conditions, sovereign debt concerns and/or any adverse regulatory developments could impact the credit markets we access and accordingly, our future liquidity and financial position. In addition, sustained or increased competition, particularly in combination with adverse economic or regulatory developments, could have an unfavorable impact on our cash flows and liquidity. See “*Risk Factors—Risks Relating to Our Financial Profile*”.

The Existing Revolving Credit Facility Agreements, the 2013 Guarantee Facility, the New Super Senior Revolving Credit Facility, the New Pari Passu Revolving Credit Facility, the New Term Loan and the 2013 Term Loan, while there are any utilizations outstanding, requires us to maintain compliance with the leverage ratios specified therein, tested as of the end of each fiscal quarter. The Existing HOT Unsecured Notes contain certain financial covenants which require HOT to maintain compliance with a maximum consolidated leverage ratio of 6.0 (calculated on a net debt basis) and minimum equity of NIS 300 million. Further, HOT may only distribute dividends if its consolidated leverage ratio (calculated on a net debt basis) is 5.5 or less. Our ability to maintain compliance with our financial covenants is dependent primarily on our or the relevant operating subsidiaries’ ability to maintain or increase EBITDA and to achieve adequate returns on our capital expenditures and acquisitions. In addition, our ability to obtain additional debt financing is limited by the incurrence leverage covenants contained in our various debt instruments. See “*Description of Other Indebtedness*”. Further, if our EBITDA were to decline, we could be required to repay or limit borrowings under the New Super Senior Revolving Credit Facility, the New Pari Passu Revolving Credit Facility and the Existing HOT Unsecured Notes, in order to maintain compliance with applicable covenants. No assurance can be given that we would have sufficient sources of liquidity, or that any external funding would be available on favorable terms, or at all, to fund any such required repayment.

Altice International is a holding company with no direct source of operating income. It is therefore dependent on dividends, servicing of intercompany loans and other payments from its operating subsidiaries to meet its liquidity requirements.

Working Capital

As of September 30, 2014, we had a negative net working capital position of €220.8 million compared to a negative working capital position of €194.5 million as of September 30, 2013. The negative working capital position is structural and follows industry norms. Customers generally pay subscription revenues early or mid-month, with short Days of Sales Outstanding and suppliers are paid in the beginning of the following month, thus generating a negative working capital. Payables due the following month are generally covered by operating cash flow. We expect our operating cash flows and, if required, available borrowings under the Existing Revolving Credit Facility Agreements, the 2013 Guarantee Facility and the New Super Senior Revolving Credit Facility and the New Pari Passu Revolving Credit Facility will be sufficient to meet our working capital requirements during the next 12 months.

Consolidated Cash Flow Statements

	Historical Consolidated Financial Information				
	For the year ended December 31,			For the nine months ended September 30,	
	2011	2012	2013	2013	2014
	€ in millions				
Cash and cash equivalents at beginning of year/period.....	18.2	19.8	129.7	129.7	61.3
Net cash provided by operating activities.....	306.4	464.5	439.2	288.8	502.7
Net cash used in investing activities.....	(576.3)	(574.2)	(1,913.6)	(502.2)	(340.8)
Net cash provided by (used in) financing activities.....	272.4	219.3	1,405.6	145.4	(83.3)
Effects of exchange rate changes on the balance of cash held in foreign currencies.....	(0.9)	0.2	0.1	—	0.7
Cash and cash equivalents at end of year/period.....	19.8	129.7	61.3	61.9	140.8

Nine Months Ended September 30, 2014 compared to the Nine Months Ended September 30, 2013

Changes in Altice International’s cash flows in the nine months ended September 30, 2014 compared to the nine months ended September 30, 2013 were impacted by the significant acquisitions and related financing arrangements described under “—*Discussion and Analysis of our Results of Operations—Nine months ended September 30, 2014 compared to the Nine months ended September 30, 2013—Significant Events Affecting Historical Results*”.

Net cash provided by operating activities

Net cash provided by operating activities increased by 74.1% to €502.7 million for the nine months ended September 30, 2014 compared to € 288.8 million for the nine months ended September 30, 2013. The increase in net cash provided by operating activities in the nine months ended September 30, 2013 was mainly related to the consolidation of ODO and Tricom into the Group resulting in strong earnings growth and the full nine month impact of Outremer.

Net cash used in investing activities

Net cash used in investing activities decreased by 32.1% to €340.8 million for the nine months ended September 30, 2014 compared to € 502.2 million for the nine months ended September 30, 2013. The decrease in cash used in investing activities for the nine month period ended September 30, 2014 compared to the nine month period ended September 30, 2013 was mainly related to the decrease in net payments on the acquisition of subsidiaries, offset by an increase in capital expenditures from €184.1 million for the nine months ended September 30, 2013 to €306.6 million for the nine months September 30, 2014, due to the consolidation of Tricom and ODO into the Group during the first and the second quarter of 2014, respectively and the impact of capital expenditures of Outremer and ONI for the entire duration of nine months ended September 30, 2014.

Net cash provided by (used in) financing activities

Net cash used in financing activities amounted to €83.3 million for the nine months ended September 30, 2014 compared to net cash provided by financing activities of €145.4 million for the nine months ended September 30, 2013 which is primarily attributable to the lower amount of debt incurred in the nine months ended September 30, 2014 compared to the nine months ended September 30, 2013 and the higher amount of interest payable on debt issued during 2013.

Year Ended December 31, 2013 compared to the Year Ended December 31, 2012

Changes in Altice International's cash flows in the year ended December 31, 2013 compared to the year ended December 31, 2012 were impacted by the significant acquisitions and related financing arrangements described under “—*Discussion and Analysis of our Results of Operations—Year Ended December 31, 2013 compared to the Year Ended December 31, 2012—Significant Events Affecting Historical Results*”.

Net cash provided by operating activities

Net cash provided by operating activities decreased by 5.5% to €439.2 million for the year ended December 31, 2013 compared to €464.5 million for the year ended December 31, 2012. The decrease in net cash provided by operations was mainly related to the increase in income taxes paid by the Group for the year ended December 31, 2013 as compared to the year ended December 31, 2012 from a cash refund of €1.6 million in the year ended December 31, 2012 to a payment of €2.3 million made in the year ended December 31, 2013

Net cash used in investing activities

Net cash used in investing activities increased by 233.3% to €1,913.6 million for the year ended December 31, 2013 compared to €574.2 million for the year ended December 31, 2012. The increase in the year ended December 31, 2013 can be attributed to higher cash outflow as a result of (i) the acquisition of certain subsidiaries (OMT, ONI, MCS and SportV), (ii) the buyback of minority interests in Coditel and (iii) the buy-out of Cabovisao non-controlling interests each of which occurred in 2013.

Additionally, this balance reflects the cash that was held in escrow as of December 31, 2013, which amounted to the equivalent of €1,234.9 million for the acquisition of ODO and Tricom in the first quarter of 2014. We completed the Tricom Acquisition on March 12, 2014 and the ODO Acquisition on April 9, 2014.

Net cash provided by (used in) financing activities

Net cash provided by financing activities increased by 540.9% to € 1,405.6 million for the year ended December 31, 2013 compared to € 219.3 million for the year ended December 31, 2012. The increase can primarily be attributed to the 2013 December Senior Secured Notes and the 2013 December Dollar Senior Notes issued on December 5, 2013 proceeds of which were being held in escrow as of December 31, 2013, and which were released in 2014 upon the completion of the ODO Acquisition and the Tricom Acquisition, respectively.

Such proceeds were therefore accounted for as restricted cash (€ 1,234.9 million) as of December 31, 2013.

Part of these proceeds were used to repay existing debts in the Altice International group, amounting to total of €657.1 million. Cash flow from financing activities also includes payments made to the holders of subordinated debt instruments issued by Altice International, for a total of €212.5million.

Year Ended December 31, 2012 compared to the Year Ended December 31, 2011

Changes in Altice International's cash flows in the year ended December 31, 2012 compared to the year ended December 31, 2011 were impacted by the significant acquisitions and related financing arrangements described under “—*Discussion and Analysis of our Results of Operations—Year Ended December 31, 2012 compared to the Year Ended December 31, 2011—Significant Events Affecting Historical Results*”.

Net cash provided by operating activities

Net cash provided by operating activities increased by 51.6% to € 464.5 million for the year ended December 31, 2012 compared to € 306.4 million for the year ended December 31, 2011. Despite a net loss of €189.8 million in 2012 compared to a net gain in income of € 123.9 million in 2011, the operating cash flow in 2011 was offset by the elimination of higher non-cash gains of € 133.0 million relating to the step acquisition of HOT (see Note 27 to Altice International's 2011 Historical Consolidated Financial Statements). This increase was slightly offset by a €60.2 million negative impact from the movement in changes in working capital.

Net cash used in investing activities

Net cash used in investing activities decreased by 0.4% to €574.2 million for the year ended December 31, 2012 compared to €576.3 million for the year ended December 31, 2011. The decrease was primarily due to the higher cash outflows of €347.3 million in the year ended December 31, 2011 for acquisitions (including investments in the HOT Telecom Group and Coditel) compared to €35.1 million the year ended December 31, 2012. In addition, we used €172.9 million to acquire the remaining minority interests in HOT in the take-private transaction in December 2012 which is included in cash used in investing activities. This decrease was partially offset by higher capital expenditures in the year ended December 31, 2012 as discussed under “—*Capital Expenditures—Year Ended December 31, 2012 compared to the Year Ended December 31, 2011*”.

Net cash provided by (used in) financing activities

Net cash provided by financing activities decreased by 19.5% to € 219.3 million for the year ended December 31, 2012 compared to € 272.4 million for the year ended December 31, 2011. The decrease was primarily due to the higher levels of interest paid in an amount of € 117.8 million in the year ended December 31, 2012 compared to € 69.0 million in the year ended December 31, 2011 and the dividends paid to the minority shareholders in an amount of €26.0 million in the year ended December 31, 2012 which was partially offset by the higher levels of debt incurred for purposes other than refinancing of existing indebtedness in the year ended December 31, 2012 (in an amount of € 363.2 million versus €341.8 million in the year ended December 31, 2011).

Capital Expenditures

We classify our capital expenditures in the following categories.

Cable based services related: Includes capital expenditures related to (i) connection of customer premises and investment in hardware, such as set-top boxes, routers and other equipment, which is directly linked to RGU growth (“CPEs and installation related”); (ii) investment in improving or expanding our cable network, investments in the television and fixed-line platforms and investments in Docsis network capacity (“cable network and construction related”) and (iii) other capital expenditures related to our cable based business.

Mobile services related: Includes capital expenditures related to improving or expanding our mobile networks and platforms and other investments relating to our mobile business.

B2B and others: Includes capital expenditures relating to data centers, backbone network, connection fees of clients premises, rental equipment to customers and other B2B operations as well as content related capital expenditures relating to our subsidiaries that produce and distribute content. Capital expenditures relating to network and equipment that is common to the delivery of cable or mobile services on the one hand and B2B on the other hand are reflected in cable capital expenditures or mobile capital expenditures as the case may be.

The following tables set forth the cash capital expenditures of the Altice International Group:

	Historical Consolidated Financial Information				
	For the year ended December 31,			For the nine months ended September 30,	
	2011	2012	2013	2013	2014
	€ in millions				
Cable based services.....	127.1	252.1	204.0	137.7	186.1
Mobile services.....	47.1	83.8	62.4	38.9	74.8
B2B and others	15.5	11.1	23.8	7.5	45.6
Total Capital Expenditures	189.8	347.0	290.1	184.1	306.6

Nine months ended September 30, 2014 compared to the Nine months ended September 30, 2013

Capital expenditures on a Historical Consolidated Basis

For the nine months ended September 30, 2014, our total capital expenditures were €306.6 million (representing 22.3% of revenue), a 66.5% increase compared to €184.1 million for the nine months ended September 30, 2013 (representing 19.8% of revenue).

Cable based services related: For the nine months ended September 30, 2014, cable based services capital expenditures were €186.1 million (representing 60.7% of total capital expenditures), a 35.2% increase compared to €137.7 million (representing 74.8% of total capital expenditures) for the nine months ended September 30, 2013.

Mobile services related: For the nine months ended September 30, 2014, mobile services capital expenditures were €74.8 million (representing 24.4% of total capital expenditures), a 92.3% increase compared to €38.9 million (representing 21.1% of total capital expenditures) for the nine months ended September 30, 2013.

B2B and others: For the nine months ended September 30, 2014, B2B and other capital expenditures were €45.6 million (representing 14.9% of total capital expenditures), a 508% increase compared to €7.5 million (representing 4.1% of total capital expenditures) for the nine months ended September 30, 2013.

Capital expenditures on a Pro Forma Consolidated Basis

The following table sets forth our cash capital expenditures by country of operation and on a total aggregate basis based on the Pre-PT Transaction Pro Forma Financial Information for the nine months ended September 30, 2013 and 2014, respectively.

Pre-PT Transaction Pro Forma Financial Information ⁽⁵⁾													
For the nine months ended September 30,													
2013							2014						
Israel	Belgium and Luxembourg	Portugal	French Overseas Territories ⁽²⁾	Dominican Republic ⁽⁴⁾	Others ⁽¹⁾	Total	Israel	Belgium and Luxembourg	Portugal	French Overseas Territories ⁽²⁾	Dominican Republic ⁽⁴⁾	Others ⁽¹⁾	Total
€ in millions													
Capital expenditures.....													—
CPEs and installations.....	35.0	5.8	7.9	3.1	—	—	51.8	46.5	6.1	2.4	5.1	—	6.0
Cable network and constructions.....	25.0	2.1	4.1	5.1	—	—	36.3	34.7	1.9	3.9	10.1	—	2.7
Other cable.....	40.0	5.6	2.7	0.2	—	—	48.5	51.8	4.1	1.8	7.6	—	1.3
Cable based services.....	100.0	13.5	14.7	8.4	—	—	136.6	133.0	12.0	8.1	22.8	—	10.0
Mobile services.....	36.0	1.2	—	8.9	38.9	—	85.0	22.8	—	—	12.3	48.4	—
B2B and others.....	—	—	3.6	9.8	—	13.4	26.8	—	2.3	10.0	0.3	—	33.1
Total capital expenditures.....	136.0	14.7	18.3	27.1	38.9	13.4	248.4	155.8	14.3	18.1	35.4	48.4	43.1
EBITDA —total capital expenditures.....	133.9	20.7	26.8	35.0	93.8	4.0	314.2	158.8	22.1	26.2	37.3	101.6	11.5

(1) Others include our B2B telecommunications solutions business and datacenter operations in Switzerland (Green and Green Datacenter), our datacenter operations in France (Auberimmo) and our content production and distribution businesses in France and Luxembourg (Ma Chaîne Sport and SportV). We disposed of our interests in Valvision (which was included in Others) in 2013 to the Numericable Group. Green Datacenter and Auberimmo are designated as unrestricted subsidiaries under the terms governing the indebtedness of the Group. Others for the nine months ended September 30, 2014, it also includes the contribution made by Tricom from March 12, 2014. See note 3 hereto for details.

(2) For the French Overseas Territories, cable based services capital expenditures includes capital expenditures relating to cable based services we provide in Guadeloupe and Martinique as well as the xDSL based broadband internet (including IPTV) and fixed-line telephony services we provide in Guadeloupe, Martinique, French Guiana, La Réunion and Mayotte. For the nine months ended September 30, 2014 it also includes the contribution of Mobius. See note 3 below for details.

(3) Total capital expenditures for the nine months ended September 30, 2014 includes the contribution of Mobius since its consolidation into the Group from January 1, 2014. For the nine months ended September 30, 2014, Mobius generated €1.3 million of capital expenditures in B2B and other. Mobius has no other capital expenditures. Total capital expenditures for the nine months ended September 30, 2014 also includes the contribution made by Tricom from March 12, 2014. For the nine months ended September 30, 2014, Tricom had total capital expenditure of € 13.2 million, cable-based service capital expenditure of €9.0 million and B2B/Other capital expenditure of €4.2 million.

(4) Excludes Tricom.

(5) Pre-PT Transaction Pro Forma Financial Information for the nine months ended September 30, 2013 and 2014, respectively, gives pro forma effect to the acquisition of ODO, but does not give pro forma effect to the acquisition of PT Portugal, Tricom and Mobius nor the disposal of our mobile network assets in Mayotte and La Réunion which we have committed to undertake. Since the financial information for Tricom and Mobius have been consolidated into the Historical Consolidated Financial Information of the Group from January 1, 2014 and March 12, 2014, respectively, following the consummation of the Mobius Acquisition on January 1, 2014 and the Tricom Acquisition on

March, 12, 2014, the Pre-PT Transaction Pro Forma Financial Information for the nine months ended September 30, 2014 includes the contribution of Tricom and Mobius from the periods for which each of these entities have been consolidated.

Israel: For the nine months ended September 30, 2014, our total capital expenditures in Israel were €155.8 million (representing 49.9% of total capital expenditures); a 14.6% increase compared to € 136.0 million for the nine months ended September 30, 2013 (representing 54.7% of total capital expenditures). The increase in capital expenditures in the cable segment in the nine months ended September 30, 2014 was due to (i) the costs relating to the launch of a project to increase node segmentation for better network quality, (ii) the higher investment in the set-top box installation process to reduce multiple customer visits and (iii) the increase in “FiberBox” installations following its launch in March 2014. The decrease in capital expenditures in the mobile segment was due lower site deployments in the nine months ended September 30, 2014 as compared to the same period last year.

Belgium and Luxembourg: For the nine months ended September 30, 2014, our total capital expenditures in Belgium and Luxembourg were € 14.3 million (representing 4.5% of total capital expenditure), a 2.8% decrease compared to €14.7 million (representing 5.9% of total capital expenditure) for the nine months ended September 30, 2013. The decrease was due to the fact that a variety of exclusive television rights were purchased and capitalized in 2013. We also incurred lower investment costs in cable modem termination systems in the nine months ended September 30, 2014, as compared to the nine months ended September 30, 2013.

Portugal: For the nine months ended September 30, 2014, our total capital expenditures in Portugal were €18.1 million (representing 5.8% of total capital expenditures), a 1.1% decrease compared to € 18.3 million for the nine months ended September 30, 2013 (representing 7.3% of total capital expenditures). This was due to a decrease in cable based services capital expenditure resulting from lower activity and the revision of expansion investments, offset by an increase in B2B and other capital expenditure incurred by ONI as a result of the reclassification of certain expenses which were previously capitalized and expensed as operating costs (comprising of costs relating to the right of use of fiber optic backbone network, installation costs and engineering personnel expenses).

French Overseas Territories: For the nine months ended September 30, 2014, our total capital expenditures in the French Overseas Territories were €35.4 million (representing 11.2% of total capital expenditures), a 30.6% increase compared to €27.1 million for the nine months ended September 30, 2013 (representing 10.9% of total capital expenditures). The increase was primarily due to (i) the acquisition of the exclusivity right for the television channel I24 News, and (ii) the repurchase of network equipment initially sold to contractors for cable network maintenance projects, following the decision to discontinue the outsourcing of such projects.

Dominican Republic: For the nine months ended September 30, 2014, our total capital expenditures in the Dominican Republic were €48.4 million (representing 15.5% of total capital expenditures), a 24.4% increase compared to €38.9 million for the nine months ended September 30, 2013 (representing 15.7% of total capital expenditures). The increase related primarily to the acquisition of a 900MHZ frequency band in the second quarter of 2014.

Others: Capital expenditures for our other businesses increased in the nine months ended September 30, 2014 to €43.1 million as compared to €13.4 million for the nine months ended September 30, 2013.

Year Ended December 31, 2013 compared to the Year Ended December 31, 2012

Capital expenditures on a Historical Consolidated Basis

For the year ended December 31, 2013, our total capital expenditures were €290.1 million (representing 22.5% of revenue), a 19.6% decrease compared to €347.0 million for the year ended December 31, 2012 (representing 31.8% of revenue).

Cable based services related: For the year ended December 31, 2013, cable based services capital expenditures were €202.5 million (representing 70.0% of total capital expenditures); a 19.6% decrease compared to €252.1 million (representing 72.7% of total capital expenditures) for the year ended December 31, 2012.

Mobile services related: For the year ended December 31, 2013, mobile services capital expenditures were €62.4 million (representing 21.6% of total capital expenditures); a 25.6% decrease compared to € 83.8 million (representing 24.1% of total capital expenditures) for the year ended December 31, 2012.

B2B and others: For the year ended December 31, 2013, B2B and other capital expenditures were €24.4 million (representing 8.4% of total capital expenditures); a 119.8% increase compared to €11.1 million (representing 3.2% of total capital expenditures) for the year ended December 31, 2012.

Capital expenditures on a Pro Forma Consolidated Basis and Aggregated Basis

The following table sets forth our cash capital expenditures by country of operation and on a total aggregate basis based on the Pre-PT/ODO Transactions Pro Forma Financial Information for the year ended December 31, 2013 and on an aggregated basis based on the Illustrative Aggregated Selected Financial Information for the year ended December 31, 2012.

	Illustrative Aggregated Selected Financial Information					Pre-PT/ODO Transactions Pro Forma Financial Information						
	For the year ended December 31, 2012					For the year ended December 31, 2013						
	Israel ⁽³⁾	Belgium and Luxembourg	Portugal	French Overseas Territories ⁽²⁾	Others ⁽¹⁾	Total	Israel ⁽³⁾	Belgium and Luxembourg	Portugal	French Overseas Territories ⁽²⁾	Others ⁽¹⁾	Total
	€ in millions											
Capital expenditures												
CPEs and installations	98.1	4.4	8.7	7.5	—	118.8	49.0	8.3	9.4	3.9	0.3	70.9
Cable network and constructions	55.7	6.4	7.1	7.7	—	76.8	43.0	2.8	7.4	4.3	—	57.5
Other cable	57.8	6.2	2.4	0.9	—	67.3	63.3	10.5	1.5	1.2	—	76.4
Cable based services	211.6	17.0	18.1	16.1	—	262.8	155.3	21.5	18.3	9.5	0.3	204.8
Mobile services	83.8	—	—	9.2	—	93.0	53.6	—	—	8.3	—	61.9
B2B and others	—	—	12.7	10.5	18.7	41.9	—	1.4	5.7	18.5	21.8	47.5
Total capital expenditures	295.4	17.0	30.8	35.7	18.7	397.8	208.9	23.0	24.0	36.2	22.1	314.2
EBITDA—total capital expenditures	9.8	28.6	17.2	39.4	1.6	96.6	154.1	22.1	34.2	48.3	(2.2)	256.5

- (1) Others include our B2B telecommunications solutions business and datacenter operations in Switzerland (Green and Green Datacenter), our datacenter operations in France (Auberimmo) and our content production and distribution businesses in France and Luxembourg (Ma Chaîne Sport and SportV). We disposed of our interests in Valvision (which was included in Others) in 2013 to the Numericable Group. Green Datacenter and Auberimmo are designated as unrestricted subsidiaries under the terms governing the indebtedness of the Group.
- (2) For the French Overseas Territories, cable based services capital expenditures includes capital expenditures relating to cable based services we provide in Guadeloupe and Martinique as well as the xDSL based broadband internet (including IPTV) and fixed-line telephony services we provide in Guadeloupe, Martinique, French Guiana, La Réunion and Mayotte.
- (3) In Israel, costs relating to the purchase of exclusive third party content have only been capitalized with effect from April 1, 2013. Consequently, the capital expenditures for the year ended December 31, 2012 do not include any costs relating to the purchase of exclusive third party content and the capital expenditures for the year ended December 31, 2013 do not include costs relating to the purchase of exclusive third party content incurred in the period prior to April 1, 2013.

Israel: For the year ended December 31, 2013, our total capital expenditures in Israel were €208.9 million (representing 66.5% of total capital expenditures); a 29.3% decrease compared to €295.4 million for the year ended December 31, 2012 (representing 74.3% of total capital expenditures). This decrease was primarily due to higher capital expenditures during the twelve months ended December 31, 2012, related mainly to a one time capital expenditure for the purchase of a building for our call center operations, capital expenditures relating to the purchase of our new set top boxes, HOT Magic HD, and higher cable network and constructions related capital expenditure related to the completion of the upgrade to 100Mb capacity throughout our cable network and the fiber roll out in certain areas in 2012. The decrease in capital expenditures in the mobile segment was primarily due to higher expenditures relating to the expansion of our UMTS network in the twelve months ended December 31, 2012 prior to the launch of our UMTS based cellular services in May 2012.

Belgium and Luxembourg: For the year ended December 31, 2013, our total capital expenditures in Belgium and Luxembourg were €23.0 million (representing 7.3% of total capital expenditure), a 36.5% increase compared to €17.0 million (representing 4.3% of total capital expenditure) for the year ended December 31, 2012. The increase was due to the installation work we conducted following the acquisition of the AIESH concession and the launch of LaBox in 2013, having installed a substantial number of set-top boxes during the twelve months ended December 31, 2013 and capitalization of certain exclusive copyrights.

Portugal: For the year ended December 31, 2013, our total capital expenditures in Portugal were €24.0 million (representing 7.6% of total capital expenditures), a 22.1% decrease compared to €30.8 million for the twelve month ended December 31, 2012 (representing 7.7% of total capital expenditures). This was due to a decrease in B2B and other capital expenditure incurred by ONI in the twelve months ended December 31, 2013, offset by an increase in cable capital expenditure mainly due to the high level of investments made during year ended December 31, 2013 to deploy 'LaBox'.

French Overseas Territories: For the year ended December 31, 2013, our total capital expenditures in the French Overseas Territories were € 36.2 million (representing 11.5% of total capital expenditures), a 1.5% increase compared to €35.7 million for the year ended December 31, 2012 (representing 9% of total capital expenditures). The increase was primarily due to the expansion of our 3G mobile networks in Martinique, Guadeloupe, French Guiana, Mayotte and La Reunion and a major renovation work relating to Outremer's distribution network as well as due to the development of a payment platform offering value-added payment services to Outremer's customers and the acquisition of KERTElcom, a small fixed line French operator.

Others: Capital expenditures for our other businesses increased by 18.2% in the year ended December 31, 2013 to €22.1 million as compared to €18.7 million for the year ended December 31, 2012.

Year Ended December 31, 2012 compared to the Year Ended December 31, 2011

Capital expenditures on a Historical Consolidated Basis

For the year ended December 31, 2012, our total capital expenditures were €347.0 million (representing 31.8% of revenue), a 82.8% increase compared to €189.9 million for the year ended December 31, 2011 (representing 24.2% of revenue).

Cable based services related: For the year ended December 31, 2012, cable based services capital expenditures were €252.1 million (representing 72.7% of total capital expenditures), a 98.3% increase compared to €127.1 million (representing 67.0% of total capital expenditures) for the year ended December 31, 2011.

Mobile services related: For the year ended December 31, 2012, mobile services capital expenditures were €83.8 million (representing 24.1% of total capital expenditures), a 77.9% increase compared to € 47.1 million (representing 24.8% of total capital expenditures) for the year ended December 31, 2011.

B2B and others: For the year ended December 31, 2012, B2B and other capital expenditures were €11.1 million (representing 3.2% of total capital expenditures), a 28.4% decrease compared to €15.5 million (representing 8.2% of total capital expenditures) for the year ended December 31, 2011.

Capital expenditures on an Aggregated Basis

The following table sets forth our cash capital expenditures by country of operation and on a total aggregate basis based on the Illustrative Aggregated Selected Financial Information.

	Illustrative Aggregated Selected Financial Information											
	For the year ended December 31, 2011					For the year ended December 31, 2012						
	Israel	Belgium and Luxembourg	Portugal	French Overseas Territories	Others	Total	Israel	Belgium and Luxembourg	Portugal	French Overseas Territories	Others	Total
	€ in millions											
Capital expenditures												
CPEs and installations	57.3	5.2	12.4	6.4	—	81.3	98.1	4.4	8.7	7.5	—	118.8
Cable network and constructions	36.9	2.8	5.4	13.0	—	58.1	55.7	6.4	7.1	7.7	—	76.8
Other cable based services	32.7	2.6	1.6	8.7	—	45.6	57.8	6.2	2.4	0.9	—	67.3
Cable based services	126.8	10.6	19.4	28.1	—	185.0	211.6	17.0	18.1	16.1	—	262.8
Mobile services	47.1	—	—	17.2	—	64.3	83.8	—	—	9.2	—	93.0
B2B and others	—	—	15.0	8.1	21.5	44.6	—	—	12.7	10.5	18.7	41.9
Total capital expenditures	173.9	10.6	34.4	53.5	21.5	293.8	295.4	17.0	30.8	35.7	18.7	397.8
EBITDA—total capital expenditures...	153.1	30.4	4.6	19.0	(3.8)	203.2	9.8	28.6	17.2	39.4	1.6	96.6

(1) Others includes our B2B telecommunications solutions business and datacenter operations in Switzerland (Green and Green Datacenter), our datacenter operations in France (Auberimmo) and our content production and distribution businesses in France and Luxembourg (Ma Chaîne Sport and SportV.) We disposed of our interests in Valvision (which was included in Others) in 2013 to the Numericable Group. Green Datacenter and Auberimmo are designated as unrestricted subsidiaries under the terms governing the indebtedness of the Group.

(2) For the French Overseas Territories, cable based services capital expenditures includes capital expenditures relating to cable based services we provide in Guadeloupe and Martinique as well as the xDSL based broadband internet (including IPTV) and fixed-line telephony services we provide in Guadeloupe, Martinique, French Guiana, La Réunion and Mayotte.

Israel: For the year ended December 31, 2012, our total capital expenditures in Israel were €295.4 million (representing 74.3% of total capital expenditures), a 69.9% increase compared to €173.9 million for the year ended December 31, 2011 (representing 59.2% of total capital expenditures). This increase was primarily due to increased CPE and installation related capital expenditures as a result of higher capital expenditure incurred during the first two quarters of 2012 relating to our new set top boxes (HOT Magic HD) as well as significantly higher mobile related capital expenditures primarily due to the expansion of our UMTS network. We also experienced an increase in cable network and construction related capital expenditures as a result of the expenditure incurred to complete the upgrade to 100Mb capacity throughout our cable network and fiber roll out in certain areas in 2012. In addition, other cable capital expenditures increased as a result of a one time capital expenditure related to the purchase of a building which houses one of our call center operations and due to an increase in capitalized sales commissions relating to our cable operations.

Belgium and Luxembourg: For the year ended December 31, 2012, our total capital expenditures in Belgium and Luxembourg were €17.0 million (representing 4.3% of total capital expenditures), a 60.4% increase compared to €10.6 million for the year ended December 31, 2011 (representing 3.6% of total capital expenditures). The increase was primarily due to the increase in total cable capital expenditures as a result of higher fees paid for exclusive rights for premium channels (amounting to € 1.2 million) and due to the acquisition of the AIESH concession (amounting to

€2.5 million) as well as relating to a project for the Brussels police involving installation of fiber links for the CCTV network (amounting to €0.6 million).

Portugal: For the year ended December 31, 2012, our total capital expenditures in Portugal were €30.8 million (representing 7.7% of total capital expenditures), a 10.5% decrease compared to €34.4 million for the year ended December 31, 2011 (representing 11.7% of total capital expenditures). The decrease was primarily due to a decrease in B2B and other capital expenditure incurred by ONI as a result of the significant capital expenditures in 2011 relating to the acquisition of a new VOIP technology platform. In addition, cable capital expenditures decreased mainly due to lower CPE and installation related capital expenditures as a result of the high level of investments made during the year ended December 31, 2011 to deploy set-top boxes with PVR functionality and the impact of the renegotiation of contracts with suppliers relating to installation service as well as due to a reduction in the number of subscribers.

French Overseas Territories: For the year ended December 31, 2012, our total capital expenditures in the French Overseas Territories were € 35.7 million (representing 9.0% of total capital expenditures), a 33.1% decrease compared to €53.5 million for the year ended December 31, 2011 (representing 18.2% of total capital expenditures). The decrease was primarily due to the higher level of cable capital expenditures incurred in the year ended December 31, 2011 as a result of major IRU upgrades in the Caribbean region as well as major mobile related investments in 2011, which included launching 3G mobile services in Mayotte and investments in real-time billing software.

Others: Capital Expenditures for our other businesses were € 18.7 million for the year ended December 31, 2012 compared to € 21.5 million for the year ended December 31, 2011, a decrease of 13.0%. This decrease was primarily due to the decrease in capital expenditures incurred by Green and Green Datacenter in the year ended December 31, 2012 which was partially offset by the increase in activity in our content business and the capital expenditure incurred by our content subsidiaries in 2012. These content subsidiaries (which we acquired in 2013) were incorporated in 2011 and 2012 respectively and hence did not have a full year of operations in 2011.

Contractual obligations

The following table summarizes the payments that we will be obligated to make under our material contractual commitments as of September 30, 2014. The information presented in the table below reflects management's estimates of the contractual maturities of our obligations. These maturities may differ significantly from the actual maturity of these obligations.

Payments due by period

	Period ending December 31,				Total
	2014	2015	2016	2017 or later	
	€ in millions				
Long-term debt obligations	2	159	43	7,237	7,441
Finance leases	12.6	7.3	5.0	10.4	35.3
Operating leases ⁽¹⁾	55.7	45.2	30.9	50.3	182.1
Total	70.3	211.5	78.9	7,297.7	7,658.4

(1) Includes lease of buildings, office equipment and vehicles for various terms through 2020. Does not take into account any optional extension periods. Includes operating leases of ODO.

In addition, we have other contractual obligations incurred in the ordinary course of business, including commitments relating to building or upgrading network infrastructure, purchase of set-top boxes, modems, mobile handsets and other end-user equipment and various maintenance and support contracts primarily relating to the maintenance and support of network infrastructure and equipment, purchase commitments for content, royalty payments to regulatory authorities and authors' rights to societies and commitments under interconnection contracts. For further details regarding our significant contractual commitments, see note 32 to Altice International's financial statements as of and for the year ended December 31, 2013 and note 31 to Altice International's financial statements as of and for the year ended December 31, 2012 respectively.

In addition, we have obligations under the ODO acquisition agreement to pay certain purchase price adjustments in the near term to the seller of ODO, Wirefree Services Denmark A/S and certain of its affiliates, in relation to the ODO Acquisition. This amounts to €36 million and we have reserved an equivalent amount of our cash and cash equivalents for this purpose.

In addition, we have obligations under defined benefit and defined contribution pension plans. Our cash outflow relating to these obligations will vary depending on a number of factors. In the case of defined benefit plans, we recognize a

liability regarding employee benefits in the statement of financial position of Altice International which represents the present value of the defined benefits liability less the fair value of the plan assets, and the past service costs. The liability in respect of defined benefit plans is determined using actuarial valuations. The actuarial valuation involves making assumptions with regards, among others, discount rates, expected rates of return on assets, future salary increases and mortality rates. Due to the long-term nature of these plans, such estimates are subject to uncertainty. Actuarial gains and losses are reflected in the statement of income and statement of other comprehensive income in the period in which they arise, as part of the salary costs. Deposits in a defined contribution plan in respect of severance pay or in respect of emoluments are recognized as an expense at the time of the deposit in the plan, in parallel to the receipt of the labor services from the employee and no additional provision is recognized in the financial statements. As of September 30, 2014, out total pension liabilities were €8.2 million.

Post Balance Sheet Date Events

Related Party Transactions

During the year ended December 31, 2012 and 2013 the Group paid an aggregate of €6.2 million and €0.6 million to related parties as management fees and during the nine months ended September 30, 2014 the Group paid an aggregate of €0.6 million. These fees are primarily related to consulting services provided on mergers and acquisitions and negotiations with vendors and banks.

The Group has entered into certain arrangements with Numericable, including a services agreement with respect to our operations in Belgium and Luxembourg, trade mark license agreements for use of the “Numericable” brand in Belgium and Luxembourg and the French Overseas Territories and the purchase of cable modems and set-top boxes. Additionally, except as disclosed in the notes to the historical consolidated financial statements, the Group did not have any material transactions with related parties during the years ended December 31, 2013 and 2012 and the nine months ended September 30, 2014.

Off Balance Sheet Arrangements

We are not party to any off-balance sheet arrangements that have, or are reasonably likely to have, a current or future material effect on our financial condition, changes in financial condition, revenue or expenses, results of operations, liquidity, capital expenditure or capital resources, other than the contractual commitments relating to purchase of property plant, and equipment, operating leases and others described under “—*Contractual Obligations*” or as disclosed below or in the notes to the Historical Consolidated Financial Statements of the Group included in these Listing Particulars.

Guarantees

In connection with our operations, we are required to provide a certain number of commitments in terms of performance guarantees for the completion of work, guarantees to municipalities, guarantees to suppliers and guarantees to regulators and other government agencies. At December 31, 2013, these guarantees amounted to approximately €489.5 million.

Quantitative and Qualitative Disclosures About Market Risk

Quantitative and Qualitative Disclosures About Market Risk

We are exposed to market risks relating to fluctuations in interest rates and foreign exchange rates, primarily as between the U.S. dollar, Euro, New Israeli Shekels and the Dominican peso, and use financial instruments to manage our exposure to interest rate and foreign exchange rate fluctuations.

Liquidity Risk

Ultimate responsibility for liquidity risk management rests with the board of directors, which has established an appropriate liquidity risk management framework for our short, medium and long-term funding and liquidity management requirements. We manage liquidity risk by maintaining adequate reserves, banking facilities and reserve borrowing facilities, by continuously monitoring forecast and actual cash flows, and by matching the maturity profiles of financial assets and liabilities.

Interest Rate and Related Risk

For fixed rate debt, changes in interest rates generally affect the fair value of the debt instrument, but not our earnings or cash flows. Accordingly, interest rate risk and changes in fair market value should not have a significant effect on the

fixed rate debt until we would be required to refinance such debt at maturity or, with respect to the HOT Unsecured Notes, pursuant to amortization obligations. As adjusted for the Offering, on a consolidated basis, our primary fixed rate debt obligations were in an amount equivalent to €5,445 million (including finance leases but excluding other financial liabilities) comprising of the 2012 Senior Secured Notes, the 2012 Senior Notes, the 2013 Dollar Senior Notes, the 2013 Euro Senior Notes, the HOT Unsecured Notes, the 2013 Senior Secured Notes and the Notes offered hereby, while our primary floating rate debt obligations (including finance leases but excluding other liabilities) were in an amount equivalent to €2,015 million comprising of the 2013 Term Loan entered into by Altice International, the New Term Loan and debt of Green Datacenter. In addition, any borrowings we make under the Existing Revolving Credit Facilities, the New Revolving Credit Facilities and the 2013 Guarantee Facility will bear interest at a floating rate. In addition, a portion of our debt in an amount of NIS 825 million (€177 million equivalent based on the exchange rate as of September 30, 2014), comprising Series A of the HOT Unsecured Notes, is linked to the Consumer Price Index in Israel and therefore actual amounts outstanding may vary from time to time and differ from the nominal amount outstanding.

Foreign Currency Risk

Our business is exposed to fluctuations in currency exchange rates. The HOT Group's primary transactional currency is the New Israel Shekel. ODO's primary transactional currency is the Dominican peso. The primary transactional currency of Green is Swiss Francs. The primary transactional currency of Altice International and its other operating subsidiaries is the euro. We conduct, and will continue to conduct, transactions in currencies other than such primary transactional currencies, particularly the U.S. dollar. Our existing debt is primarily denominated in U.S. dollars, euros and New Israeli Shekels although the amounts incurred in euros and New Israeli Shekels do not necessarily match the amount we earn in the corresponding currency. We seek to manage such transactional foreign currency exposures through our hedging policy in accordance with our specific business needs. As of September 30, 2014, we had the following derivative instruments outstanding to secure foreign currency liabilities and to reduce foreign currency exposure:

- Foreign exchange forward contract relating to a swap of a notional amount of \$550 million into New Israeli Shekels (maturing on December 15, 2017);
- Foreign exchange forward contract relating to interest rate hedging on a notional amount of \$98.9 million and €40.1 million (maturing on each interest payment date under the 2012 Senior Secured Notes and the 2012 Senior Notes until December 15, 2017), which exchanges fixed euro and U.S. dollar payments into fixed New Israeli Shekels payments;
- Cross currency swaps on notional principal amounts of \$200 million, \$225 million and €100 million, each swapping into New Israeli Shekels at certain specified rates (maturing on December 15, 2017); and
- Cross currency swaps on notional principal amounts of \$293 million, \$407 million and \$133 million, each swapping into New Israeli Shekels and Euros respectively at certain specified rates (maturing between July and November 2018).

In connection with the New Transactions, we expect to enter into various derivative instruments.

In addition, because the reporting currency of the Company is the Euro while the reporting currency of the HOT Group and Green is New Israeli Shekels and Swiss Francs respectively, we are exposed to translation foreign currency exchange risk arising from the consolidation of such entities into the Company's consolidated financial statements. For more information on our foreign currency translation risk and sensitivity analyses, please see note 19 to Altice International's financial statements as of and for the year ended December 31, 2013.

Critical Accounting Policies, Judgments and Estimates

See note 1 to our Historical Consolidated Financial Information included elsewhere in these Listing Particulars.

MANAGEMENT'S DISCUSSION AND ANALYSIS OF FINANCIAL CONDITION AND RESULTS OF OPERATIONS OF THE PT PORTUGAL GROUP

The discussion and analysis below provides information that we believe is relevant to an assessment and understanding of the PT Portugal Group's historical consolidated financial condition and results of operations. You should read this discussion in conjunction with PTC's audited standalone annual financial statements for the years ended December 31, 2013 and 2012 and related notes prepared in accordance with Portuguese GAAP therein (the "PTC Audited Financial Statements"), Meo, S.A.'s audited standalone annual financial statements for the years ended December 31, 2013 and 2012 and related notes prepared in accordance with Portuguese GAAP therein (the "Meo Audited Financial Statements" and, together with the PTC Audited Financial Statements, the "Audited Financial Statements"), the unaudited condensed financial information of PTC and Meo, S.A. for the nine-month periods ended September 30, 2014 and 2013 (the "Interim Financial Information"), the PT Portugal Unaudited Combined Adjusted Financial Information and the PT Portugal Pre-Closing Unaudited Combined Pro forma Balance Sheet (together the "PT Portugal Combined Selected Financial Information"), the Pro Forma Financial Information and the other financial information included elsewhere in these Listing Particulars. In this section, unless the context otherwise requires, the terms "Group", "we", "us" and "our" refers only to PT Portugal and its subsidiaries.

Basis of Presentation

On December 9, 2014, we entered into an agreement to acquire from Oi 100% of the issued share capital of PT Portugal, and accordingly, the PT Portugal Group and its assets. The PT Portugal Group represents the existing business of Portugal Telecom outside of Africa and Asia and excludes African entities (other than Open Ideia (Angola), Open Ideia (Morocco) and Contact Cabo Verde), and PT Portugal's Rio Forte debt securities, Oi treasury shares and the PT Portugal financing vehicles.

These Listing Particulars includes, and unless otherwise stated the discussion below is based solely on, the audited stand alone financial statements of PTC and Meo, S.A., prepared in accordance with Portuguese GAAP which are the most material subsidiaries of the PT Portugal Group, as of and for the years ended December 31, 2013 and 2012 (including unaudited comparative information as of and for the year ended December 31, 2011) and the unaudited condensed financial statements of PTC and Meo, S.A. as of and for the nine months ended September 30, 2013 and 2014 prepared in accordance with Portuguese GAAP (the "PT Historical Financial Information"). The PT Historical Financial Information does not consolidate the results of operations of the entire business undertaking of the PT Portugal Group as it existed as of December 31, 2012 or 2013 or September 30, 2013 or 2014 for all of the periods presented. As a result, these Listing Particulars also includes the PT Portugal Combined Selected Financial Information, which has been compiled by aggregating selected financial information with appropriate adjustments and eliminations made for intra-group transfers extracted from (i) the audited historical financial statements of PTC and Meo, S.A. for each of the years ended December 31, 2011, 2012 and 2013 and the unaudited historical condensed financial statements of PTC and Meo, S.A. for each of the nine months ended September 30, 2013 and 2014 and (ii) the unaudited historical condensed financial information of the other subsidiaries in the PT Portugal Group derived from the internal financial reporting systems of the PT Portugal Group. For further details, see "*PT Portugal Combined Selected Financial Information—Basis of Presentation*".

Except as otherwise stated, the PT Portugal Combined Selected Financial Information have not been discussed below. For the nine months ended September 30, 2014, PTC and Meo, S.A. collectively represented over 97% and 95% of the PT Portugal Group's revenues and EBITDA as derived from the PT Portugal Combined Selected Financial Information. For further details, please refer to "*Presentation of Financial and Other Information—PT Portugal Financial Information*" and "*PT Portugal Combined Selected Financial Information*".

The discussion below is based on the PT Historical Financial Information, which comprises stand-alone financial information of PTC and Meo, S.A., and therefore does not give effect to any intercompany eliminations that would customarily be included in consolidated financial statements or that have been given effect to in the PT Portugal Combined Selected Financial Information included elsewhere in these Listing Particulars. As a result, although we believe that the discussion below reflects the key factors and trends that have had an impact on the results of operations of the PT Portugal Group in the periods discussed, you should not rely on the PTC and Meo, S.A. financial information presented below or the discussion of such financial information (or any aggregation thereof) as a substitute for an analysis of the results of operations of the PT Portugal Group. Among other things, the financial information and discussion included below does not eliminate intercompany revenues or costs between PTC and Meo, S.A. or among the other entities that will form a part of the PT Portugal Group after giving effect to the PT Portugal Acquisition, includes equity from earnings of affiliated companies (including the subsidiaries of PTC and Meo, S.A., as applicable) and includes cash flows from dividends, loan repayments or other distributions from subsidiaries, each of which would be eliminated in a consolidation of financial information. In addition, given PTC and Meo, S.A. operate within the broader PT Portugal Group, which provides integrated telecommunication services, the allocation of costs and revenues presented in the standalone financial information of PTC and Meo, S.A. is only indicative and may not reflect the actual revenues

and costs of such entities had they operated as separate businesses, especially in relation to the allocation of revenues from and costs of certain multiple-play packages provided by the PT Portugal Group. PT Portugal has effected a merger between PTC and Meo, S.A. on December 29, 2014, with PTC as the surviving entity, which was renamed MEO—Serviços de Comunicações e Multimédia, S.A. See “*General Description of our Business and the Offering—Recent Developments*”. For the financial information of the PT Portugal Group, please refer to the PT Portugal Combined Selected Financial Information included in these Listing Particulars.

Prior to the merger between PTC and Meo, S.A., PTC was the primary operating company through which the PT Portugal Group provided its fixed line services, including residential services (Pay-TV, broadband internet and fixed-line telephony services to residential customers), enterprise services and wholesale and other services. Meo, S.A. was the primary operating company through which the PT Portugal Group provided its mobile services, including personal services and, to a lesser extent, enterprise services and wholesale and other services. Therefore, references to PTC in the discussion below primarily reflect the results of the fixed line business of the PT Portugal Group and references to Meo, S.A. below primarily reflect the results of the mobile business of the PT Portugal Group.

Significant Factors Affecting Results of Operations

The Group’s operations and the operating metrics discussed below have been, and may continue to be, affected by certain key factors as well as certain historical events and actions. In addition to the regulatory and macroeconomic environment, and significant industry trends in the global telecommunications sector, the key factors affecting the ordinary course of our Group’s business and our results of operations include: (i) increasing competitive pressures, (ii) macro-economic developments, (iii) traffic trends, (iv) changes in revenue mix, (v) decreasing fixed line calling prices and greater focus on pricing plans, (vi) decreasing interconnection charges, (vii) continuing introduction of new products, (viii) continuing investments in our network, (ix) decreases in wholesale and enterprise revenues, (x) our redundancy programs and (xi) derecognition of deferred tax assets. Each of these factors is discussed in more detail below.

- *Increasing Competitive Pressure.* Our businesses face increasingly strong competition from fixed line operators (including VoIP providers) as well as from mobile players. We face aggressive competition from NOS (formerly named ZON Optimus), Vodafone and other corporate solutions operators in the Portuguese telecommunications sector. Our major competitors compete through their respective multiple-play offers, which include traditional voice services as well as Pay-TV and broadband internet services and, on the corporate side, complex telecom and IT/IS solutions. The competitive landscape changed significantly in Portugal in recent years with the merger of ZON and Optimus to create NOS and the construction of a FTTH network by Vodafone, which resulted in two new integrated telecommunications operators. These events have further increased the focus on bundled offers and the evolution of triple-play to quadruple-play services as a way to satisfy perceived consumer appetite for bundles that provide them with simplicity, convenience and good value.
- *Macro-economic developments.* Our operations are subject to macro-economic risks that are outside of our control. Our results of operations in the period under review have been affected by adverse economic conditions and austerity measures in Portugal which had a negative effect on consumer confidence. High levels of sovereign debt, combined with weak growth and high unemployment, could lead to low consumer demand, fiscal reforms (including austerity measures), sovereign debt restructurings, currency instability, increased counterparty credit risk, high levels of volatility and, potentially, disruptions in the credit and equity markets, as well as other outcomes that might adversely impact our financial condition.
- *Traffic Trends.* In recent years, we have experienced a decrease in traffic on our fixed line network, primarily as a result of the trend among consumers to use mobile phones rather than fixed line service and increasing competition from mobile operators, other fixed line operators and, more recently, cable and VoIP providers. This decrease in traffic has negatively affected both our residential and wholesale revenues.
- *Changes in Revenue Mix.* Our Pay-TV customers have increased since we introduced Pay-TV service in 2008. In addition, our ADSL residential accesses increased by 3.3% in 2013 due to our marketing of service packages that include Pay-TV and ADSL broadband services. The mix of the revenues of our residential business has shifted significantly in recent years, with Pay-TV related revenues partially offsetting the continued pressure on the traditional fixed voice business. In each of the last three years, for example, we achieved positive net additions of fixed lines, primarily due to strong performance of *Meo* double-play and triple-play offers, as well as the launch of *M4O*, our quadruple play offer. We expect that Pay-TV and broadband services offered through our multiple-play package will continue to be an important driver of our fixed line business, and the architecture and regulation of the developing fiber optic network in Portugal will be an important factor affecting our business and revenues.
- *Decreasing Fixed Line Calling Prices and Greater Focus on Pricing Plans.* Retail calling prices, particularly for regional, national and international calls, have been decreasing steadily in recent years, which have negatively affected our residential and personal revenues (which includes revenues from telecommunications and mobile data

services for a variety of personal devices, including cell phones). One of our strategies in response to this trend has been to aggressively market a variety of pricing plans to promote customer loyalty in our competitive market. Our pricing plans tend to increase our revenues from fixed charges but contribute to a decrease in our traffic revenues and therefore lower ARPU, particularly with respect to the growing percentage of pricing plans that offer calls at a flat rate. We aggressively use pricing plans for both our residential and personal services.

- *Decreasing Mobile Interconnection Charges.* In 2005, ANACOM declared all mobile operators, including *Meo*, to have significant market power in call termination in the mobile networks market. As a result, ANACOM imposed price controls on interconnection charges that have caused both fixed- to-mobile and mobile-to-mobile interconnection rates to decrease steadily. ANACOM has issued successive decisions that have reduced mobile termination rates over time. These reductions have had, and will continue to have, a significant adverse impact on revenues and results of operations from our mobile operations which are partially offset by the lower interconnection costs we incur for calls made or received by our customers.
- *Continuing Introduction of New Products.* The fast development and availability of new access devices are leading to significant growth in internet users and more frequent usage, leading to increased bandwidth consumption. Examples of this trend are smartphones, tablet PCs and internet tablets. In January 2013, we announced the launch of a quadruple-play offer of converged fixed-mobile services by *Meo*, which includes pay-TV, internet, fixed telephone and mobile telephone services. The launch of our quadruple play offer enabled us to reach a household penetration of 1.7 million RGUs and helped promote customer migration from prepaid to post-paid (by approximately 190,000 customers).
- *Continuing Investments in our Network.* Remaining competitive requires continuing investments to build out our third- and fourth-generation mobile network and develop new services, and our capital expenditures on our mobile network have increased in recent years. In 2011, we acquired a fourth- generation mobile license, under which *Meo* provides services using LTE technology, which represents an evolution from the GSM and UMTS technologies and allows for higher levels of bandwidth and speed. In July 2014, we entered into an agreement with Vodafone Portugal to deploy, swap capacity on and share FTTH networks, for an initial term of 25 years. This agreement provides us with an enhanced ability to distribute broadband and television offers with high speeds and quality. See “*Description of PT Portugal’s Business—Material Contracts—Fiber Sharing Agreement with Vodafone Portugal*”. We expect the sharing of FTTH networks with Vodafone Portugal to reduce the need to further build out our FTTH networks and to reduce our capital expenditures on such networks in the future. The recent investments in our FTTH network have reduced operating costs relating to customer support and network maintenance costs.
- *Decreases in Wholesale Revenues.* In our wholesale business, the decrease in regulated fixed-to-mobile interconnection charges has also affected our revenues. This is because our wholesale unit records revenue from international incoming calls through our network that terminate on the networks of mobile operators. Decreases in transit traffic (calls that use our network but neither originate nor terminate on our network) also have affected our wholesale revenues.
- *Decreases in Enterprise Revenues.* Enterprise revenues, which relate to services provided to corporate and medium and small business customers, including data and business solutions services, have been decreasing over the past few years reflecting both the adverse economic conditions in Portugal and more intense competition.
- *Redundancy programs.* The redundancy programs undertaken in the past few years have led to a reduction in wages and salaries payable to the employees who became either pre-retired or suspended. The net present value of those salaries payable up to retirement is recorded as an actuarial obligation and are not recognized under wages and salaries, thereby having a positive impact on our operating expenditures. Nevertheless, we remain obligated to pay salaries to such pre-retired or suspended employees up to their retirement age, although salaries payable to pre-retired or suspended employees are lower than the salaries paid previously to those same employees, translating into a cash flow saving.
- *Derecognition of deferred tax assets.* The change in the statutory tax rate applicable to PTC as from January 2014, from 25% to 23%, has led to PTC remeasuring its deferred tax assets and derecognizing certain deferred tax assets. In accordance with public statements of the Portuguese Tax Authorities, we expect that the statutory tax rate will decrease further in future years, resulting in further derecognizing of certain deferred tax assets.

Key Performance Indicators

Overview

Our management uses a number of key performance indicators to track the performance of our businesses and to guide management. We use these indicators in addition to our Portuguese GAAP financial measures in order to evaluate,

monitor and manage our business. These metrics allow us to review our core operating activities, enabling us to evaluate relevant trends more meaningfully when considered in conjunction with (but not in lieu of) measures that are calculated in accordance with Portuguese GAAP. None of these metrics are measures of financial performance under Portuguese GAAP, nor have these measures been audited or reviewed by an auditor, consultant or expert. As defined by our managers, these terms may not be directly comparable to similar key terms used by competitors.

The following table sets forth the total number of retail lines (or accesses) and net retail additions for PTC and the total number of mobile customers, net retail additions and data as a percentage of mobile service revenues for Meo, as of the dates indicated below.

	As of December 31,			As of September 30,	
	2011	2012	2013	2013	2014
	in thousands except number of RGUs per individual user and ARPU or unless otherwise indicated				
PTC					
Fixed retail accesses (residential and enterprise):					
PSTN/ISDN ⁽¹⁾	2,648	2,604	2,549	2,564	2,503
Broadband customers	1,105	1,225	1,294	1,280	1,354
Pay-TV customers	1,042	1,223	1,315	1,294	1,387
Total fixed retail accesses	4,795	5,052	5,158	5,137	5,224
Triple or Quadruple Play customers	679	833	952	921	1,065
Unique customers	2,851	2,814	2,745	2,766	2,670
Total fixed retail accesses/unique customer	1.68	1.80	1.88	1.86	1.96
Non-voice revenues as % of revenues	46.2	51.2	53.2	53.0	55.2
Net additions:⁽²⁾					
PSTN/ISDN	(48)	(43)	(55)	(40)	(46)
Broadband customers	104	119	69	55	60
Pay-TV customers	212	181	91	70	73
Total fixed retail accesses net additions	268	257	105	85	87
Residential⁽³⁾					
Fixed retail accesses (residential only)					
PSTN/ISDN	1,674	1,692	1,646	1,652	1,631
Broadband customers	911	1,015	1,027	1,019	1,075
Pay-TV customers	972	1,135	1,157	1,146	1,209
Total fixed retail accesses	3,557	3,841	3,830	3,817	3,915
Triple or Quadruple Play customers	623	769	824	803	912
Unique customers	1,881	1,881	1,818	1,830	1,779
Total fixed retail accesses/unique customer	1.89	2.04	2.11	2.09	2.20
ARPU (€/month)	30.8	31.6	31.6	31.7	31.9
Non-voice revenues as % of revenues	58.5	63.4	65.7	65.4	68.2
Net additions⁽²⁾					
PSTN/ISDN	1	18	(22)	(16)	(15)
Broadband customers	102	104	29	22	48
Pay-TV customers	198	162	43	31	52
Total fixed retail accesses net additions	300	284	50	36	85
Enterprise⁽⁷⁾					
Fixed retail accesses (Enterprise only)					
PSTN/ISDN	826	725	720	727	695
Broadband customers	193	207	264	258	276
Pay-TV customers	68	86	155	146	176
Total fixed retail accesses net additions	(30)	(68)	60	51	8
Unique customers	846	745	724	730	724
Total fixed retail accesses/unique customer	1.28	1.37	1.57	1.55	1.58
Non-voice revenues as % of revenues	46.4	50.3	55.0	53.9	58.4
Meo, S.A.					
Total mobile customers (personal and enterprise)	7,444	7,598	7,896	7,807	7,881
Post-paid	2,378	2,469	2,925	2,782	3,554
Prepaid	5,066	5,129	4,971	5,025	4,327
Data as percentage of mobile services revenues	27.7	32.6	36.5	36.2	39.2
Net additions:⁽²⁾					
Total mobile customers	24	154	298	209	(15)
Post-paid	87	91	456	313	629
Pre-paid	(63)	63	(158)	(104)	(644)
Personal⁽⁴⁾					
Total mobile customers (personal only)	5,932	6,024	6,390	6,320	6,336
Post-paid	1,064	1,093	1,570	1,457	2,132
Prepaid	4,868	4,931	4,820	4,863	4,205
Minutes of Usage (MOU) (m) ⁽⁵⁾	89	93	98	96	106
ARPU (€/month)	9.7	8.7	7.6	7.7	7.3
Customer	8.7	8.0	7.1	7.2	6.7
Interconnection	1.0	0.7	0.5	0.5	0.6
SARC ⁽⁶⁾ (€)	27.8	27.8	24.6	24.7	23.4
Data as % of mobile service revenues	30.9	33.2	35.8	35.6	38.2
Net Additions⁽²⁾					
Total Mobile Customers (Personal only)	(31)	92	312	243	(53)

Post-paid.....	42	30	441	328	562
Prepaid.....	(73)	62	(129)	(85)	(615)
Enterprise⁽⁷⁾					
Total mobile customers (enterprise only).....	1,445	1,514	1,457	1,433	1,503
Net Additions⁽²⁾					
Total Mobile Customers.....	55.6	68.7	(3.8)	(28.2)	45.7

- (1) The public switched telephone network, or PSTN, is the traditional telephone system that runs through copper lines. The integrated digital services network, or ISDN, is the digital telecommunications network that allows simultaneous voice and data transmission over an access line.
- (2) The net additions figures for the nine months ended September 30, 2013 and 2014 are calculated on a nine-month basis from December 31, 2012 and 2013, respectively.
- (3) The PT Portugal Group's residential customer category provides fixed line telephone and broadband services, pay-TV services (IPTV over ADSL and fiber and DTH satellite TV) services and internet access services to residential customers. PTC is the primary operating company through which the PT Portugal Group provides such residential services.
- (4) The PT Portugal Group's personal customer category provides telecommunications and mobile data services for a variety of personal devices, including traditional cell phones, smartphones, tablets and laptops through our mobile business. Meo, S.A. is the primary operating company through which the PT Portugal Group provides its mobile services.
- (5) Minutes of Usage represents the monthly average of outgoing traffic in minutes divided by the average number of users in the period.
- (6) Subscriber Acquisition and Retention Cost, or SARC, equals the sum of 70% of marketing and publicity costs *plus* commissions *plus* subsidies, divided by gross additions *plus* upgrades.
- (7) The PT Portugal Group's enterprise customer category provides enterprise services (including integrated voice, data and image solutions, virtual private networks, convergence solutions, consultancy and outsourcing) to corporate, SMEs and SoHo customers that need diversified telecommunications solutions and integration with IT services through service packages. PTC and, to a lesser extent, Meo, S.A., are the primary operating companies through which the PT Portugal Group provides its enterprise services.

Nine Months Ended September 30, 2014 Compared to Year Ended December 31, 2013

For the nine months ended September 30, 2014, PTC's business continued to show stable customer growth, with fixed retail customers increasing by 1.3% to 5.22 million as of September 30, 2014 (with net additions of 66,000 in the nine months ended September 30, 2014) as compared to 5.16 million as of December 31, 2013. Mobile customers decreased slightly by 0.2% to 7.88 million as of September 30, 2014 (with net deductions of 15,000 in the nine months ended September 30, 2014) as compared to 7.90 million as of December 31, 2013, primarily as a result of a decrease in prepaid customers which was partially offset by an increase in post-paid customers (with net additions of 629,000 post-paid customers in the nine months ended September 30, 2014), reflecting the success of our quadruple-play offering, namely *M4O*, having surpassed 3 million RGUs in October 2014.

The growth of fixed retail customers was underpinned by a solid performance of *Meo*, with pay-TV customers increasing by 5.5% to 1.39 million (with net additions of 72,000 in the nine months ended September 30, 2014) as of September 30, 2014 as compared to 1.32 million as of December 31, 2013. This increase was due to the continued success and the attractiveness of *Meo* in the Portuguese market, even against a backdrop of difficult economic environment. Our triple and quadruple-play customers (voice, broadband and pay-TV) accounted for 87,000 of net additions in the nine months ended September 30, 2014, reaching 1.1 million customers as of September 30, 2014 (up by 11.9% as compared to 1.0 million customers as of December 31, 2013). This increase was partially offset by the decrease in the number of PSTN/ISDN retail lines to 2.50 million as of September 30, 2014 from 2.55 million as of December 31, 2013, reflecting a trend among consumers to use mobile phones rather than fixed line services and increasing competition from mobile operators, fixed line operators, cable and VoIP operators.

Meo, S.A.'s mobile customers increased primarily as a result of the growth of post-paid customers, which increased by 21.5% to 3.6 million as of September 30, 2014 (with net additions of 629,000 in the nine months ended September 30, 2014) as compared to 2.9 million as of December 31, 2013. This increase in post-paid customers was due to the continued success of *M4O*, which led to a migration from pre-paid to post-paid mobile customers (resulting in net deductions of 644,000 in our pre-paid customers in the nine months ended September 30, 2014). As of September 30,

2014, 45.1% of our mobile subscriber base was on post-paid contracts as compared to 37.0% as of December 31, 2013. We believe the trend of migration from prepaid to post-paid mobile contracts is positive for our business.

As of September 30, 2014, 39.9% of the PT Portugal Group's unique subscribers had subscribed to either a triple-play or quadruple-play offer, as compared to 34.7% as of December 31, 2013. We believe the trend to higher penetration of multi-play subscriptions will benefit our business through reduced churn.

Year Ended December 31, 2013 Compared to Year Ended December 31, 2012

In 2013, overall, PTC's business continued to show stable customer growth, with fixed retail customers increasing by 2.1% to 5.2 million in 2013 (with net additions of 105,000 in 2013) as compared to 5.1 million in 2012. Mobile customers also increased by 3.9% to 7.9 million in 2013 (with net additions of 298,000) as compared to 7.6 million in 2012, primarily as a result of an increase in post-paid customers (with net additions of 456,000 post-paid customers in 2013), reflecting the success of our quadruple-play offering, namely *M4O*, having reached 1.5 million RGUs as of December 31, 2013.

The growth of fixed retail customers was underpinned by a solid performance of *Meo*, with pay-TV customers increasing by 7.5% to 1.3 million (with net additions of 91,000 in 2013) in 2013 as compared to 1.2 million in 2012. This increase was due to the continued success and the attractiveness of *Meo* in the Portuguese market, even against a backdrop of difficult economic environment and already high penetration of pay-TV. Our triple-play customers (voice, broadband and pay-TV) accounted for 119,000 of net additions in 2013, reaching 952,000 customers (up by 14.3% as compared to 833,000 customers in 2012). This increase was partially offset by the decrease in the number of PSTN/ISDN retail lines to 2.5 million in 2013 from 2.6 million in 2012, reflecting a trend among consumers to use mobile phones rather than fixed line services and increasing competition from mobile operators, fixed line operators, cable and VoIP operators.

In 2013, *Meo*, S.A.'s mobile customers increased primarily as a result of the growth of post-paid customers, which increased by 18.5% to 2.9 million (with net additions of 456,000 in 2013) in 2013 as compared to 2.5 million in 2012. This increase in post-paid customers was due to the launch of the convergent offer, *M4O*, which led to a migration from pre-paid to post-paid mobile customers (resulting in net deductions of 158,000 in our pre-paid customers), and from the growth of the "Unlimited" tariff plans (an increase of 11.8% to 298,000 in 2013 as compared to 267,000 in 2012). The "Moche" tariff plans also continued to show solid growth trends (an increase of 18.0% in 2013 to 1.9 million, as compared to 1.6 million in 2012). As of December 31, 2013, 37.0% of our mobile subscriber base was on post-paid contracts as compared to 32.5% as of December 31, 2012.

As of December 31, 2013, 34.7% of the PT Portugal Group's unique subscribers had subscribed to either a triple-play or quadruple-play offer, as compared to 29.6% as of December 31, 2012.

Year Ended December 31, 2012 Compared to Year Ended December 31, 2011

In 2012, PTC's business continued to show steady customer growth, with fixed retail customers increasing by 5.4% to 5.1 million in 2012 (with net additions of 257,000 in 2012) as compared to 4.8 million in 2011. Mobile customers also increased by 2.1% to 7.6 million in 2012 (with net additions of 154,000) as compared to 7.4 million in 2011, with net additions of 91,000 post-paid customers and 63,000 prepaid customers in 2012.

The growth of fixed retail customers was underpinned by a solid performance of *Meo*, with pay-TV customers increasing by 17.4% to 1.2 million (with net additions of 181,000 in 2012) in 2012 as compared to 1.0 million in 2011. This increase was due to the continued success and the attractiveness of *Meo* in the Portuguese market, even against a backdrop of difficult economic environment and already high penetration of pay-TV. This performance of pay-TV underpinned a solid growth of fixed broadband customers, increasing by 10.9% to 1.2 million in 2012 (with net additions of 119,000 in 2012) as compared to 1.1 million in 2011. Our triple-play customers (voice, broadband and pay-TV) increased by 22.7% to 833,000 in 2012 (with 154,000 of net additions in 2012) as compared to 679,000 in 2011. The success of *Meo* is anchored on the back of a distinguished and convergent value proposition, which leverages on a non-linear pay-TV service offering, a seamless multiscreen experience with live TV channels, video on demand and games and music on demand on multiple devices.

In 2012, *Meo*, S.A.'s mobile customers increased primarily as a result of the growth of post-paid customers which increased by 3.8% to 2.5 million in 2012 (with net additions of 91,000 in 2012) as compared to 2.4 million in 2011, reflecting an improved performance in our enterprise business.

Prepaid customers increased by 1.2% to 5.13 million (with net additions of 63,000 in 2012) in 2012 as compared to 5.07 million in 2011. This increase in prepaid customers was due to the growth of the "Moche" and "e" tariff plans. The "e nunca mais acaba" tariff plans, which reached 933,000 customers in 2012, as well as the new "Moche" tariff plans,

which reached 1,593,000 customers in 2012, continued to show solid growth trends. As of December 31, 2012, 32.5% of our mobile subscriber base was on post-paid contracts as compared to 31.9% as of December 31, 2011.

As of December 31, 2012, 29.6% of the PT Portugal Group's unique subscribers had subscribed to either a triple-play or quadruple-play offer, as compared to 23.8% as of December 31, 2011.

Key Income Statement Items

Below is a summary description of certain income statement line items used by PTC and Meo, S.A. for the purpose of the discussion of their results of operations. For the purpose of the discussion below, we have regrouped certain income statement line items.

Operating Revenues

Revenues consist of income generated from services rendered and sales. Revenue is measured at fair value of the amount received or receivable. Revenue recognition is deducted from the estimated amount of returns, discounts and other rebates and does not include the Value Added Tax (VAT) and other taxes paid related to the sale.

For PTC, revenues from services rendered and sales include revenues which are generated from: (1) our residential services, which includes (i) service revenues, generated from providing fixed telephone services, pay-TV services, and generally consist of fixed charges, including network access charges based on a monthly line rental and an initial installation fee, as well as, in most cases, a monthly fee from pricing packages, which can include broadband and Pay-TV services, and traffic, including charges for the use of our fixed line network based on rates dependent on the amount and type of usage, (ii) sales revenues from the sale of telephone and broadband equipments; (2) our enterprise services, which includes traffic charges for voice and data services, outsourcing or management services and fees for business process outsourcing (BPO), and consultancy fees; and (3) our wholesale and other services, which includes primarily providing public pay telephone services and advertising on www.sapo.pt, our internet portal. For a description of revenue recognition principles, see Note 3.21 to the Audited Financial Statements of PTC.

For Meo, S.A., revenues from services rendered and sales include revenues which are generated from (i) service revenues generated from providing mobile voice telecommunication services, mobile broadband access and other mobile services, and comprise (1) customer revenues, which we receive directly from our personal and to a lesser extent, enterprise customers, consisting primarily of traffic charges, subscription and usage charges, and (2) interconnection revenues, which we receive from other telecommunication providers when their customers make calls or otherwise connect to our network from fixed lines or mobile devices; and (ii) sales revenues, which relate primarily to the sale of mobile phone and related equipment to personal and enterprise customers. For a description of revenue recognition principles, see Note 3.16 to the Audited Financial Statements of Meo, S.A.

The invoices for multiple-play packages, namely *M4O*, are issued by PTC and a portion of the total revenue is allocated to Meo, S.A. based on the ARPU for equivalent mobile post-paid services adjusted for a certain discount included in the bundle package as compared to the total standalone services. In addition, certain additional revenues not included in the base price of the package are allocated to each company based on their nature, for example, the rental of additional set-top-boxes or video on demand are allocated to PTC, while additional mobile SIM cards and roaming revenues are allocated to Meo, S.A. Direct costs are allocated to Meo, S.A. and PTC based on the criteria set out under “—*Direct costs*” below. Other costs relating to multiple-play packages are allocated in the standalone financial information of PTC and Meo, S.A. based on internal management estimates.

Equity in earnings of affiliated companies

Equity in earnings of affiliated companies includes the gains and losses in affiliated companies through the equity method of accounting and the gains and losses on the disposal of affiliated companies.

Costs of products sold and impairment of inventories

Costs of products sold include the costs attributable to the acquisition of the equipments sold by PTC and Meo, S.A., including the cost of the mobile handsets and certain fixed line equipments sold.

Impairment losses on inventories include the value of materials for which there is no intended use due to obsolescence and/or low rotation, as well as the difference between prices of materials that have a fair value lower than the average acquisition costs, when the difference is higher than the discount granted in current market conditions.

Direct costs

For PTC, direct costs include telecommunication costs, programming costs, directories, internet contents costs and other costs.

For Meo, S.A. direct costs include rental costs for capacity, interconnection costs, leasing of sites, contents of internet and mobile service costs and other costs.

Marketing and publicity

For PTC and Meo, S.A., marketing and publicity costs include expenses related to their services and brands, advertising and sale promotion, and other expenses related to marketing and publicity efforts.

Supplies and external services

Supplies and external services include expenses for maintenance and repair, commissions, support services, electricity, rentals, specialized work, communications, fuel, water and other fluids, transportation and other third- party costs.

Wages and salaries

Wages and salaries include salaries, social security, health care benefits, training and other costs relating to active personnel.

Post retirement benefits

PTC sponsors defined benefit plans, under which it grants pension supplements to retired and active employees, healthcare services to retired employees and eligible relatives and pays salaries to suspended and pre-retired employees until retirement age, the latter of which is also applicable to certain other entities of the PT Portugal Group, including Meo, S.A. Post retirement benefit costs include the pension supplements service cost related to active employees and the net interest cost on unfunded obligations in relation to the post retirement benefits obligations. For Meo, S.A., the post retirement benefit costs, which correspond to the net interest cost on salaries due to suspended and pre-retired employees until retirement age, is accounted for under the line item other expenses and losses. For more details, see “—*Post Retirement Benefits*” below.

Curtailement and settlement costs

Curtailement and settlement costs include (1) costs from redundancy programs, reflecting mainly the present value of salaries payable up to retirement age, as well as the components of pension supplements and healthcare obligations that would otherwise be recognized up to retirement age, (2) termination payments and (3) plan settlement costs or gains.

Indirect taxes

Indirect taxes include ANACOM taxes, direct taxes (which primarily include municipal property taxes), value added tax, and other non-income taxes.

Provisions and adjustments

Provisions and adjustments include impairments of accounts receivables and provisions for contingencies and other risks. Impairment of accounts receivables refers to impairments on financial assets, which are impaired when there is clear evidence that as a result of one or more events occurring after its initial recognition, their future estimated cash flows will be negatively affected (with determinative factors being the age of the accounts receivables, the risk profile of the clients and their financial situations). Impairment losses and related reversals are recorded in earnings. PTC and Meo, S.A. are party to a variety of ongoing judicial and tax proceedings for which, based on the opinion of their lawyers, they determine whether they should recognize any provisions in respect of these contingencies.

Net other income and gains/(expenses and losses)

For PTC, net other income and gains (expenses and losses) primarily include supplemental income, income and gains in non-financial investments, investment subsidies, interest due, recovery of accounts receivable, gains and losses on exchange rate differences, income from investment properties, write-off of tangible fixed assets, donations made, contractual penalties incurred, losses in inventories and other gains and losses.

For Meo, S.A. net other income and gains (expenses and losses) primarily include supplemental income, interest due, recovery of accounts receivable, gains and losses on exchange rate differences, gains in inventories, write-off of tangible fixed assets, losses in inventories, discounts granted, direct write-off of accounts receivable curtailment costs, the net interest cost on salaries due to suspended and pre-retired employees until retirement age and other gains and losses.

Depreciation and amortization

Depreciation and amortization principally includes the depreciation and amortization of tangible fixed assets, intangible assets, and investment properties. Goodwill is not amortized but tested on an annual basis for impairment losses.

Net financial expenses

Net financial expenses primarily include interest expenses related to interest paid on loans, net of interest income related to cash and cash equivalents, net foreign currency exchange losses and net other financial losses from banking services, commissions, financial discounts and other financing costs.

Income taxes

Income taxes correspond to the sum of current and deferred taxes, which are recorded in the income statement except when they relate to items recorded directly in shareholders' equity (in which case they are likewise recorded in shareholders' equity). Income taxes are estimated based on the estimate of the corporate tax base under the *Imposto sobre o Rendimento das Pessoas Coletivas*. For further details, see Note 3.11 to the Audited Financial Statements of PTC for the year ended December 31, 2013 and Note 3.8 to the Audited Financial Statements of Meo, S.A. for the year ended December 31, 2013.

Results of Operations

Nine Months Ended September 30, 2014 Compared to Nine Months Ended September 30, 2013

The table below sets out PTC's and Meo, S.A.'s results of operations for the nine months ended September 30, 2013 and 2014.⁽¹⁾

	PTC		Meo, S.A.	
	Nine Months Ended September 30,		Nine Months Ended September 30,	
	2013	2014	2013	2014
	€ in millions			
Services rendered.....	1,265.7	1,251.6	727.0	678.6
Sales	13.3	18.0	71.8	60.3
Subsidies to operation	0.04	0.2	0.004	0.003
Production variation	1.6	0.8	—	—
Equity in earnings of affiliated companies, net	161.3	(1,021.3)	123.1	(1,034.7)
Own work capitalized.....	36.2	33.9	3.3	3.5
Costs of products sold	(15.2)	(17.6)	(79.9)	(65.4)
Direct costs	(368.1)	(372.2)	(152.1)	(151.6)
Marketing and publicity	(18.9)	(14.5)	(13.6)	(10.2)
Supplies and external services	(314.2)	(318.9)	(197.5)	(184.3)
Wages and salaries	(174.3)	(176.2)	(35.5)	(35.1)
Post retirement benefit costs ⁽²⁾	(31.7)	(31.2)	—	—
Curtailed and settlement costs ⁽²⁾	(102.3)	21.9	—	—
Indirect taxes.....	(11.5)	(12.0)	(12.0)	(13.5)
Impairment of inventories ((losses)/reversals)	0.2	2.0	(1.3)	3.7
Impairment of accounts receivable ((losses)/reversals).....	(11.7)	(12.2)	(10.2)	(4.5)
Provisions (increases/reductions).....	5.2	(0.6)	(1.9)	5.5
Other income and gains.....	80.2	68.6	10.3	16.1
Other expenses and losses ⁽²⁾	(26.3)	(17.9)	(16.9)	(8.3)
Income before depreciation and amortization, financing expenses and taxes	489.5	(597.6)	414.7	(739.9)
Depreciation and amortization ((losses)/reversals)	(360.3)	(329.5)	(125.2)	(122.8)
Operating income (before financing expenses and taxes).....	129.2	(927.1)	289.5	(862.8)
Interest and related income	4.7	2.7	0.3	0.02
Interest and related expenses.....	(275.6)	(285.3)	(14.3)	(7.2)
Income before taxes.....	(141.7)	(1,209.7)	275.5	(870.0)

Income taxes	2.5	(46.7)	(46.5)	(51.4)
Net (Loss)/Income	(139.1)	(1,256.5)	229.0	(921.3)

- (1) Reflects stand-alone financial information prepared in accordance with Portuguese GAAP of PTC and Meo, S.A. and does not give effect to intercompany eliminations that would be eliminated in a consolidation of financial information. For the nine-month periods ended September 30, 2014 and 2013, the impact of intercompany eliminations between PTC and Meo, S.A. (but not including any other intercompany eliminations) on PTC's revenues would have been to reduce revenues by €94.5 million and €113.7 million, respectively, and on Meo's revenues would have been to reduce revenues by €94.2 million and €80.1 million, respectively. The net impact of intercompany eliminations between PTC and Meo, S.A. on income before depreciation and amortization and net income reflects primarily the equity in losses/earnings of Meo, S.A. recorded by PTC through the equity method of accounting, amounting to a loss of €921.3 million and a gain of €229.0 million in the nine months ended September 30, 2014 and 2013, respectively, as the other eliminations offset each other in the operating and financial results. For further details, see "*PT Portugal Combined Selected Financial Information—Basis of Presentation*".
- (2) Meo S.A. recorded post retirement benefit costs of €0.08 million and €0.03 million in the nine months ended September 30, 2014 and 2013, respectively, and curtailment costs of €3.7 million in the nine months ended September 30, 2013, both of which are included under the caption "*Other expenses and losses*" in Meo, S.A.'s standalone profit and loss statement.

Operating Revenues

For the nine months ended September 30, 2014, PTC's revenues from services rendered and sales decreased by 0.7% to €1,269.6 million from €1,279.0 million for the nine months ended September 30, 2013, reflecting primarily lower revenues in the enterprise customer category amid challenging economic conditions in Portugal.

For the nine months ended September 30, 2014, Meo, S.A.'s revenues from services rendered and sales decreased by 7.5% to €738.9 million from €798.8 million for the nine months ended September 30, 2013. This decrease was primarily due to revenue declines in the personal customer category, reflecting lower and more volatile pre-paid recharges by customers as a result of the challenging economic conditions, price competition and a migration to lower tariff plans. Data revenues accounted for 39.2% of service revenues, an increase of 3.0% over the nine months ended September 30, 2014, reflecting the solid performance of our "*internetnotelemovel*" data packages.

Costs and Expenses

Costs of products sold and impairment of inventories. PTC's costs of products sold increased by 15.8% to €17.6 million for the nine months ended September 30, 2014 from €15.2 million for the nine months ended September 30, 2013. This increase was primarily due to an increase in equipment sales. PTC's impairment reversals of inventories increased to €2.0 million for the nine months ended September 30, 2014 from €0.2 million for the nine months ended September 30, 2013. Meo, S.A.'s costs of products sold decreased by 18.1% to €65.4 million for the nine months ended September 30, 2014 from €79.9 million for the nine months ended September 30, 2013. This decrease was primarily due to our cost cutting efforts coupled with a strong focus on profitability and also lower handset subsidies on sales of handsets to our mobile customers. Meo, S.A.'s impairment reversals of inventories amounted to €3.7 million for the nine months ended September 30, 2014, as compared to impairment losses of €1.3 million for the nine months ended September 30, 2013.

Direct costs. PTC's direct costs increased by 1.1% to €372.2 million for the nine months ended September 30, 2014 from €368.1 million for the nine months ended September 30, 2013. This increase is primarily due to higher traffic costs that were partially offset by lower costs associated with our directories business. Meo, S.A.'s direct costs remained broadly stable at €151.6 million for the nine months ended September 30, 2014 as compared to €152.1 million for the nine months ended September 30, 2013.

Marketing and publicity. PTC's marketing and publicity costs decreased by 23.3% to €14.5 million for the nine months ended September 30, 2014 from €18.9 million for the nine months ended September 30, 2013. Meo, S.A.'s marketing and publicity costs decreased by 25% to €10.2 million for the nine months ended September 30, 2014 from €13.6 million for the nine months ended September 30, 2013. The decrease in marketing and publicity costs for PTC and Meo, S.A. is primarily due to the marketing campaigns for the *M4O* launch in the first quarter of 2013, the marketing efforts made in 2013 and in previous years that allowed for lower marketing investments to be made in 2014 and our strict cost control policies. These were partially offset by the marketing campaigns supporting the rebranding of Meo, S.A.'s mobile business from *TMN* to *Meo* in the first quarter of 2014.

Supplies and external services. For the nine months ended September 30, 2014, PTC's supplies and external services increased by 1.5% to €318.9 million from €314.2 million for the nine months ended September 30, 2013. This increase was primarily due to higher IT/IS support services, which were internalized in 2013 and as from 2014 were externalized to PT Cloud and Data Centers. This was partially offset by lower maintenance costs, which benefitted from the roll-out of our FTTH network, lower electricity expenses, lower billing expenses and lower consultancy and legal fees, reflecting our cost control efforts. For the nine months ended September 30, 2014, Meo, S.A.'s supplies and external services decreased by 6.7% to €184.3 million from €197.5 million for the nine months ended September 30, 2013, reflecting

primarily our focus on cost cutting and profitability that translated into lower maintenance and repair expenses and other third party services expenses.

Wages and salaries. PTC's wages and salaries, including employee benefits and social charges, increased by 1.1% to €176.2 million for the nine months ended September 30, 2014 from €174.3 million for the nine months ended September 30, 2013. This increase is primarily due to an increase in variable remunerations and training expenses. Meo, S.A.'s wages and salaries, including employee benefits and social charges, remained broadly stable at €35.1 million for the nine months ended September 30, 2014, as compared to €35.5 million for the nine months ended September 30, 2013.

Post retirement benefit costs. PTC's post retirement benefit costs remained broadly flat at €31.2 million for the nine months ended September 30, 2014 as compared to €31.7 million for the nine months ended September 30, 2013. This cost item does not include early termination costs related to our workforce reduction program, which are discussed under "—*Curtailement and settlement costs*" below.

Curtailement and settlement costs. PTC's curtailement and settlement costs amounted to a gain of €21.9 million for the nine months ended September 30, 2014 as compared to a cost of €102.3 million for the nine months ended September 30, 2013, reflecting primarily the reduction in our healthcare benefits which was put in place in 2014 and the redundancy programs relating to approximately 70 and 400 employees that were implemented in the third quarter of 2014 and the second quarter of 2013, respectively.

Indirect taxes. PTC's indirect taxes remained broadly flat at €12.0 million for the nine months ended September 30, 2014 as compared to €11.5 million for the nine months ended September 30, 2013. Meo, S.A.'s indirect taxes increased by 12.5% to €13.5 million for the nine months ended September 30, 2014 from €12.0 million for the nine months ended September 30, 2013, primarily due to an increase in fees paid to ANACOM, which reflects primarily an increase in the unitary spectrum fee per customer and the increased number of mobile customers, mainly *M4O* customers.

Provisions and adjustments (including impairment of accounts receivable and provisions for contingencies and other risks). For PTC, provisions and adjustments increased by 96.9% to €12.8 million for the nine months ended September 30, 2014 from €6.5 million for the nine months ended September 30, 2013, primarily due to higher provisions for bad debt and certain reversals of provisions for legal actions recorded in the nine months ended September 30, 2013. For Meo, S.A., provisions and adjustments decreased to a net gain of €0.9 million for the nine months ended September 30, 2014 from a net cost of €12.1 million for the nine months ended September 30, 2013, reflecting primarily lower provisions for bad debt and reversals of provisions for other risks recorded in the nine months ended September 30, 2014.

Net other income and gains/(expenses and losses). PTC's net other income and gains decreased by 5.9% to €50.7 million for the nine months ended September 30, 2014 from €53.9 million for the nine months ended September 30, 2013. This was primarily due to a net gain of €26.0 million recorded by PTC in the first quarter of 2013, which corresponds to the compensation receivable from the Portuguese State relating to the termination of the wireline concession agreement for its universal service obligations. This compensation was received in the third quarter of 2014. Meo, S.A.'s net other income and gains increased to €7.8 million for the nine months ended September 30, 2014 from €6.6 million of net other expenses and losses for the nine months ended September 30, 2013. This increase was primarily due to higher gains on the disposal of tangible fixed assets, lower costs relating to uncollectible receivables that were not adjusted for previously and work force redundancy costs recorded in the nine months ended September 30, 2013, which for Meo, S.A. are included under this caption. See "—*Key Income Statement Items*".

Equity in earnings of affiliated companies, net. For the nine months ended September 30, 2014, PTC's equity in earnings of affiliated companies decreased to a loss of €1,021.3 million from a gain of €161.3 million for the nine months ended September 30, 2013, reflecting primarily lower earnings from the equity investment in Meo, S.A. Meo, S.A.'s equity in earnings of affiliated companies decreased to a loss of €1,034.7 million for the nine months ended September 30, 2014 from a gain of €123.1 million for the nine months ended September 30, 2013. Equity in earnings of affiliated companies relate primarily to Meo, S.A.'s equity investment in PT Móveis, a wholly-owned subsidiary of Meo, S.A. The loss recorded in the nine months ended September 30, 2014 reflects primarily a net loss of €950 million that was recognized by PT Móveis, relating to the disposal to Portugal Telecom of its 100% interest in Bratel BV, the entity that held the investment in Oi.

Income before depreciation and amortization, financing expenses and taxes. PTC's income before depreciation and amortization, financing expenses and taxes decreased to a loss of €597.6 million for the nine months ended September 30, 2014 compared to an income of €489.5 million for the nine months ended September 30, 2013. Meo, S.A.'s income before depreciation and amortization, financing expenses and taxes decreased to a loss of €739.9 million for the nine months ended September 30, 2014 from an income of €414.7 million for the nine months ended September 30, 2013. The decrease in PTC and Meo, S.A.'s incomes before depreciation and amortization,

financing expenses and taxes is primarily due to lower services rendered and sales and the equity in losses of affiliated companies recorded in the nine months ended September 30, 2014, reflecting primarily a loss of €950 million recorded by PT Móveis in connection with the disposal of Bratel BV, as compared to equity in earnings recorded in the nine months ended September 30, 2013. For PTC, these effects were partially offset by lower curtailment costs, following the redundancy program undertaken in 2013. For Meo, S.A., the effects mentioned above were partially offset by lower costs of goods sold and supplies and external services reflecting lower sales and Meo, S.A.'s cost cutting efforts.

Based on the PT Portugal Combined Selected Financial Information, PTC and Meo, S.A. represented over 95.2% and 97.9% of the PT Portugal Group's EBITDA for the nine months ended September 30, 2014 and 2013, respectively. See "PT Portugal Combined Selected Financial Information". For a reconciliation between income before depreciation and amortization, financing expenses and taxes as reported by PTC and Meo, S.A. under Portuguese GAAP and EBITDA as reported by Portugal Telecom SGPS, S.A., which publishes its financial information under IFRS (the "International Format"), see "*Summary of Significant Differences between Portuguese GAAP and IFRS*".

Depreciation and amortization. PTC's depreciation and amortization costs decreased by 8.5% to €329.5 million for the nine months ended September 30, 2014 from €360.3 million for the nine months ended September 30, 2013. Meo, S.A.'s depreciation and amortization costs decreased by 1.9% to €122.8 million for the nine months ended September 30, 2014 from €125.2 million for the nine months ended September 30, 2013. The decrease in PTC's and Meo, S.A.'s depreciation and amortization costs was primarily due to the decline in capital expenditures incurred by PTC and Meo, S.A. in recent periods against the backdrop of the investments in certain technologies and networks that were undertaken in previous years, namely in FTTH and 4G-LTE.

Net interest and related income (expenses). PTC's net interest and related expenses increased by 4.3% to €282.7 million for the nine months ended September 30, 2014 from €270.9 million for the nine months ended September 30, 2013. This was due to higher interest expenses reflecting an increase in the average gross debt of PTC and higher commission expenses (such as banking fees) relating to the business combination between Portugal Telecom and Oi. Meo, S.A.'s net interest and related expenses decreased by 48.6% to €7.2 million for the nine months ended September 30, 2014 from €14.0 million for the nine months ended September 30, 2013. This was due to lower interest expenses reflecting primarily the reduction in outstanding commercial papers issued by Meo, S.A.

Income taxes. For the nine months ended September 30, 2014, PTC's income taxes amounted to €46.7 million compared to an income tax gain of €2.5 million for the nine months ended September 30, 2013, reflecting primarily lower taxable losses in the nine months ended September 30, 2014 mainly due to the curtailment costs recorded in the same period of last year. For Meo, S.A., income taxes increased to €51.4 million for the nine months ended September 30, 2014 from €46.5 million for the nine months ended September 30, 2013, reflecting higher taxable profits in 2014.

Net (Loss)/Income. For PTC, net loss increased to €1,256.5 million for the nine months ended September 30, 2014, compared to €139.1 million for the nine months ended September 30, 2013, as a result of the factors described above. For Meo, S.A., net loss amounted to €921.3 million for the nine months ended September 30, 2014 as compared to a net income of €229.0 million for the nine months ended September 30, 2013, as a result of the factors described above.

Year Ended December 31, 2013 Compared to Year Ended December 31, 2012

The table below sets out PTC's and Meo, S.A.'s results of operations for the years ended December 31, 2012 and 2013.⁽¹⁾ During the year ended December 31, 2013, PTC adopted the revised version of IAS 19 *Employee Benefits*. As a result of the adoption of the amendments to IAS 19, certain adjustments were made to the previously reported statements of financial position of PTC for the year ended December 31, 2012. The table below sets out PTC's restated results of operations for the year ended December 31, 2012 and may differ from that shown in the Audited Financial Statements of PTC for the year ended December 31, 2012. See Note 5 to the Audited Financial Statements of PTC for the year ended December 31, 2013.

	PTC		Meo, S.A.	
	Year Ended December 31, 2012	2013	Year Ended December 31, 2012	2013
	€ in millions			
Services rendered.....	1,749.2	1,686.3	1,064.6	952.0
Sales	25.1	22.0	88.7	102.5
Subsidies to operation	0.1	0.1	0.03	0.01
Production variation	(1.5)	1.1	—	—
Equity in earnings of affiliated companies, net	120.5	234.4	68.6	194.7
Own work capitalized.....	42.1	49.6	3.9	4.5
Costs of products sold	(31.6)	(24.9)	(107.4)	(113.0)

Direct costs	(484.0)	(492.2)	(225.3)	(198.6)
Marketing and publicity	(20.7)	(26.2)	(23.6)	(18.8)
Supplies and external services	(445.4)	(431.0)	(261.9)	(266.3)
Wages and salaries	(235.5)	(231.9)	(44.9)	(47.1)
Post retirement benefit costs ⁽²⁾	(57.3)	(40.3)	—	—
Curtailement and settlement costs ⁽²⁾	(1.2)	(112.8)	—	—
Indirect taxes.....	(15.4)	(14.2)	(15.8)	(14.6)
Impairment of inventories ((losses)/reversals)	3.6	0.8	4.1	(1.6)
Impairment of accounts receivable ((losses)/reversals).....	(25.3)	(23.0)	(11.2)	(9.8)
Provisions (increases/reductions).....	(8.2)	6.1	(0.4)	(1.6)
Other income and gains.....	123.8	99.4	16.0	14.9
Other expenses and losses ⁽²⁾	(28.5)	(56.5)	(22.1)	(14.5)
Income before depreciation and amortization, financing expenses and taxes.....	709.7	646.7	533.5	582.7
Depreciation and amortization ((losses)/reversals)	(497.7)	(480.9)	(180.8)	(168.2)
Operating income (before financing expenses and taxes).....	212.1	165.8	352.7	414.5
Interest and related income	15.3	6.9	1.4	0.4
Interest and related expenses.....	(321.0)	(373.0)	(22.5)	(18.8)
Income before taxes.....	(93.7)	(200.3)	331.7	396.1
Income taxes	2.3	(9.9)	(80.1)	(59.9)
Net (Loss)/Income.....	(91.3)	(210.2)	251.6	336.1

(1) Reflects stand-alone financial information of PTC and Meo, S.A. and does not give effect to intercompany eliminations that would be eliminated in a consolidation of financial information. For the years ended December 31, 2013 and 2012, the net impact of intercompany eliminations between PTC and Meo, S.A. (but not including any other intercompany eliminations) on PTC's revenues would have been to reduce revenues by €147.0 million and €160.2 million, respectively, and on MEO's revenues would have been to reduce revenues by €104.5 million and €107.8 million, respectively. The net impact of intercompany eliminations between PTC and Meo, S.A. on income before depreciation and amortization and net income reflects primarily the equity in earnings of Meo, S.A. recorded by PTC through the equity method of accounting, amounting to €336.1 million and €251.6 million for the years ended December 31, 2013 and 2012, respectively, as the other eliminations offset each other in the operating and financial results. For further details, see "PT Portugal Combined Selected Financial Information—Basis of Presentation".

(2) Meo, S.A. recorded post retirement benefit costs of €0.04 million and €0.08 million in the years ended December 31, 2013 and 2012, respectively, and curtailment costs of €4.1 million in the year ended December 31, 2013, both of which are included under the caption "Other expenses and losses" in Meo, S.A.'s standalone profit and loss statement.

Operating Revenues

PTC's revenues from services rendered and sales decreased by 3.7% to €1,708.3 million in 2013 from €1,774.3 million in 2012. This decrease was primarily due to (i) lower revenues in the enterprise customer category, where we experienced pricing and demand pressure as a result of strong cost-cutting initiatives by government agency clients and a significant reduction in investments in new projects by government agency clients, cost reduction initiatives by large corporations, particularly in banking, other financial services and pharmaceuticals, and economic challenges faced by small and medium businesses, which continued to be driven by macro-economic and financial conditions in Portugal and (ii) lower revenues from wholesale and other businesses, as a result of a decline in the directories business, leased lines and accesses, including lower prices resulting from adverse regulatory decisions and lower volumes as operators continue to build networks, and declines in revenues from public pay phones and the termination of national and international traffic. These decreases in revenues were partially offset by an increase in revenues from the residential customer category, mainly related to Pay-TV and fixed broadband revenues, which was driven by the success of the *Meo* double- and triple-play offers.

Meo, S.A.'s revenues from services rendered and sales decreased by 8.6% to €1,054.5 million in 2013 from €1,153.3 million in 2012. This decrease was primarily due to (i) revenue declines in the personal customer category, primarily due to lower mobile interconnection revenues (partially as a result of the negative impact of lower mobile termination rates), lower customer revenues (reflecting the effects of challenging economic conditions that have made customers more price-sensitive, greater competitive pressures, increased popularity of "tribal plans" yielding lower revenues per user, as well as the negative effect of lower revenues from mobile broadband due to the higher popularity of fixed broadband), and price pressures from competitors and migrations to lower tariff plans and (ii) lower revenues in the enterprise customer category, where we experienced pricing and demand pressure, due to the reasons mentioned above. Data revenues accounted for 36.5% and 32.6% of service revenues for the years ended December 2013 and 2012, respectively, an increase of 3.9%, reflecting the continued success of Meo, S.A.'s mobile data offers which are based on a high quality network offering and a high capacity to meet customer demands for increasingly higher bandwidth.

Costs and Expenses

Costs of products sold and impairment of inventories. PTC's costs of products sold decreased by 21.2% to €24.9 million in 2013 from €31.6 million in 2012. This decrease was primarily due to lower costs related to the sale of set-top boxes, which were higher in 2012 following the switch-off of the analog television network in Portugal and the switch to DTT. PTC's reversal on inventory impairment provisions decreased by 77.8% to €0.8 million in 2013 from €3.6 million in 2012. Meo, S.A.'s costs of products sold increased by 5.2% to €113.0 million in 2013 from €107.4 million in 2012. This increase was primarily due to an increase in sales of mobile phones, which was partially offset by a decrease in the average cost of handsets as a result of favourable contracts signed with key suppliers. Meo, S.A.'s impairment losses of inventories increased to €1.6 million in 2013 from a reversal of €4.1 million in 2012.

Direct costs. PTC's direct costs increased by 1.7% to €492.2 million in 2013 from €484.0 million in 2012. This increase is primarily due to an increase in programming costs, driven by customer growth and investment in content for our *Meo* offering, and higher costs associated with the provision of IT/IS solutions and outsourcing services as a result of the increased contribution of these services to our revenues. The increase in direct costs was partially offset by lower costs associated with our directories business. Meo, S.A.'s direct costs decreased by 11.9% from €225.3 million in 2012 to €198.6 million in 2013, primarily due to lower mobile traffic costs as a result of a reduction in services rendered and the impact of the regulatory mobile termination rate cuts.

Marketing and publicity. PTC's marketing and publicity costs increased by 26.6% to €26.2 million in 2013 from €20.7 million in 2012. This increase was primarily due to the costs incurred in the launch and rollout of our new *M4O* offer which more than offset our strict cost control policies and marketing investments already made in previous years. Meo, S.A.'s marketing and publicity costs decreased by 20.3% to €18.8 million in 2013 from €23.6 million in 2012, reflecting the abovementioned strict cost control policies.

Supplies and external services. PTC's supplies and external services expenses decreased by 3.2% to €431.0 million in 2013 from €445.4 million in 2012. This decrease was primarily due to lower maintenance and repairs expenses and other third-party services, which benefited from the roll-out of our FTTH network and an extensive field force transformation program. Meo, S.A.'s supplies and external services expenses increased by 1.7% to €266.3 million in 2013 from €261.9 million in 2012. This increase reflects higher commissions and support services, partially offset by lower legal and consultancy fees.

Wages and salaries. PTC's wages and salaries, including employee benefits and social charges, decreased to €231.9 million in 2013 from €235.5 million in 2012, a decrease of 1.5%. The decreases in wages and salaries for PTC was primarily due to lower variable and overtime compensation, higher efficiency levels in certain internal processes and lower personnel costs as a result of a restructuring plan implemented in the second quarter of 2013. Meo, S.A.'s wages and salaries, including employee benefits and social charges, increased to €47.1 million in 2013 from €44.9 million in 2012, an increase of 4.9%. The increase in wages and salaries for Meo, S.A. was primarily due to higher variable compensation.

Post retirement benefit costs. PTC's post retirement benefit costs decreased by 29.7% to €40.3 million in 2013 from €57.3 million in 2012, primarily reflecting the reduction in discount rates undertaken at the end of 2012, leading to a lower net interest cost in 2013. The post retirement benefits costs in 2012 were restated in order to reflect the impact of the adoption of the amendments to IAS 19. This cost item does not include early termination costs related to our workforce reduction program, which are discussed under "*—Curtailment and settlement costs*" below.

Curtailment and settlement costs. PTC's curtailment and settlement costs increased to €112.8 million in 2013 from €1.2 million in 2012, reflecting the implementation of a redundancy program relating to approximately 400 employees in the second quarter of 2013. Curtailment and settlement costs in 2012 were also restated in order to reflect the impact of the adoption of the amendments to IAS 19.

Indirect taxes. PTC's indirect taxes decreased by 7.8% to €14.2 million in 2013 from €15.4 million in 2012. Meo, S.A.'s indirect taxes decreased by 7.6% to €14.6 million in 2013 from €15.8 million in 2012. The decrease in PTC and Meo, S.A.'s indirect taxes was primarily due to lower fees paid to ANACOM.

Provisions and adjustments. For PTC, provisions and adjustments decreased by 49.6% to €16.9 million in 2013 from €33.5 million in 2012, primarily due to a decrease in provisions for legal actions that benefited from a favorable outcome in a pending action and lower provisions for bad debt. For Meo, S.A., provisions and adjustments decreased by 1.7% to €11.4 million in 2013 from €11.6 million in 2012, primarily due to a decrease in provisions for bad debt. This was partially offset by an increase in provisions for legal actions.

Net other income and gains/(expenses and losses). PTC's net other income and gains decreased by 55.0% to €42.9 million in 2013 from €95.3 million in 2012. This was primarily due to a €60.0 million one-off gain recorded in

2012 relating to compensation received by PTC in connection with its universal service obligations under its concession agreement, which was partially offset by a €26.0 million one-off gain recorded in 2013 relating to the early settlement of the concession agreement. Meo, S.A.'s net other income and gains amounted to €0.4 million in 2013 as compared to €6.1 million of net other expenses and losses in 2012. This was primarily due to lower non-recurring adjustments for accounts receivables.

Equity in earnings of affiliated companies, net. PTC's equity in earnings of affiliated companies increased by 94.5% to €234.4 million in 2013 from €120.5 million in 2012, reflecting an increase in the earnings of Meo, S.A., a wholly-owned subsidiary of PTC. Meo, S.A.'s equity in earnings of affiliated companies increased by 183.8% to €194.7 million in 2013 from €68.6 million in 2012. This increase was predominantly due to a non-recurring gain of €134.5 million recorded by Bratel Brasil (which is a subsidiary of Bratel BV) relating to the settlement of certain liabilities in connection with the acquisition of the investment in Oi. This gain was reflected in Meo, S.A.'s equity in earnings of affiliated companies through its share in the earnings of PT Móveis, an entity that held an investment in Bratel BV which in turn held the investments in Oi and its controlling shareholders.

Income before depreciation and amortization, financing expenses and taxes. PTC's income before depreciation and amortization, financing expenses and taxes decreased by 8.9% to €646.7 million in 2013 from €709.7 million in 2012, primarily due to (i) lower revenues reflecting, as explained above, lower margins in new services provided by the enterprise segment and a continuous decline in the directories business, (ii) higher curtailment costs, reflecting the redundancy program undertaken in 2013 and (iii) lower other income and gains, reflecting primarily the gains recorded in both periods relating to the wireline concession agreement, as explained above. These effects were partially offset by higher equity in the earnings of affiliated companies, reflecting higher earnings at Meo, S.A.

Meo, S.A.'s income before depreciation and amortization, financing expenses and taxes increased by 9.2% to €582.7 million in 2013 from €533.5 million in 2012, primarily due to higher equity in the earnings of affiliated companies, reflecting higher earnings at PT Móveis which, through its subsidiary Bratel BV held the investment in Oi. This was partially offset by lower services rendered due to the factors explained above.

Based on the PT Portugal Combined Selected Financial Information, PTC and Meo, S.A. represented over 93.9% and 97.4% of the PT Portugal Group's EBITDA for the years ended December 31, 2013 and 2012, respectively. See "PT Portugal Combined Selected Financial Information". For a reconciliation between income before depreciation and amortization, financing expenses and taxes as reported by PTC and Meo, S.A. under Portuguese GAAP and EBITDA as reported by Portugal Telecom SGPS, S.A., see "—Summary of Significant Differences between Portuguese GAAP and IFRS".

Depreciation and amortization. PTC's depreciation and amortization costs decreased by 3.4% to €480.9 million in 2013 from €497.7 million in 2012. This decrease was primarily due to a decline in capital expenditures following the investments in its FTTH network and an extensive field force transformation program in previous years. Meo, S.A.'s depreciation and amortization costs decreased by 7.0% to €168.2 million in 2013 from €180.8 million in 2012, primarily due to a decline in capital expenditures in 2013 and late 2012 following the investments in certain technologies and networks undertaken in previous years, particularly in 4G coverage.

Net interest and related income (expenses). PTC's net interest and related expenses increased by 19.8% to €366.1 million in 2013 from €305.7 million in 2012. This was primarily due to a significant increase in the average net debt of PTC during the year ended December 31, 2013, reflecting the increased issuance of commercial papers by PTC and subscribed by PT Finance. Meo, S.A.'s net interest expenses decreased 12.8% to €18.4 million in 2013 from €21.1 million in 2012, reflecting lower outstanding debt, namely the intercompany loan of €340.0 million due to PTC that was repaid in 2013. This was partially offset by the €250.0 million of commercial papers that were issued in 2013.

Income taxes. For the year ended December 31, 2013, PTC's income taxes amounted to €9.9 million compared to an income tax gain of €2.3 million for the year ended December 31, 2012. This was primarily due to the change in the statutory tax rate applicable to PTC as from January 2014 from 25% to 23%, as a result of which PTC remeasured its deferred tax assets as of December 31, 2013 and accordingly recorded a deferred tax loss amounting to €13.5 million in 2013. For Meo, S.A., income taxes decreased from €80.1 million in 2012 to €59.9 million in 2013. This decrease was due to lower taxable earnings, primarily reflecting the decline in revenues.

Net (Loss)/Income. For PTC, net loss increased by 130.2% to €210.2 million in 2013, compared to €91.3 million in 2012, as a result of the factors described above. For Meo, S.A. net income increased by 33.6% to €336.1 million in 2013, compared to €251.6 million in 2012, as a result of the factors described above.

Year Ended December 31, 2012 Compared to Year Ended December 31, 2011 (unaudited)

The table below sets out PTC's and Meo, S.A.'s results of operations for the years ended December 31, 2011 and 2012.⁽¹⁾

	PTC		Meo, S.A.	
	Year Ended December 31,		Year Ended December 31,	
	2011	2012	2011	2012
	€ in millions			
Services rendered.....	1,765.1	1,749.2	1,151.1	1,064.6
Sales.....	31.7	25.1	92.9	88.7
Subsidies to operation.....	0.1	0.1	—	0.03
Production variation.....	(0.7)	(1.5)	—	—
Equity in earnings of affiliated companies, net.....	153.3	120.5	50.3	68.6
Own work capitalized.....	40.5	42.1	2.9	3.9
Costs of products sold.....	(38.8)	(31.6)	(109.3)	(107.4)
Direct costs.....	(413.4)	(484.0)	(226.3)	(225.3)
Marketing and publicity.....	(26.2)	(20.7)	(29.6)	(23.6)
Supplies and external services.....	(474.0)	(445.4)	(279.6)	(261.9)
Wages and salaries.....	(240.1)	(235.5)	(48.0)	(44.9)
Post retirement benefit costs ⁽²⁾	(53.9)	(51.7)	—	—
Curtailed and settlement costs ⁽²⁾	(32.9)	(0.9)	—	—
Indirect taxes.....	(13.8)	(15.4)	(15.4)	(15.8)
Impairment of inventories ((losses)/reversals).....	6.7	3.6	1.4	4.1
Impairment of accounts receivable ((losses)/reversals).....	(13.7)	(25.3)	(5.0)	(11.2)
Provisions (increases/reductions).....	(8.5)	(8.2)	2.6	(0.4)
Other income and gains.....	51.1	123.8	18.4	16.0
Other expenses and losses ⁽²⁾	(22.8)	(28.5)	(19.4)	(22.1)
Income before depreciation and amortization, financing expenses and taxes.....	709.7	715.6	587.1	533.5
Depreciation and amortization ((losses)/reversals).....	(518.0)	(497.7)	(194.4)	(180.8)
Operating income (before financing expenses and taxes).....	191.8	218.0	392.6	352.7
Interest and related income.....	24.5	15.3	5.6	1.4
Interest and related expenses.....	(323.5)	(321.0)	(22.9)	(22.5)
Income before taxes.....	(107.2)	(87.8)	375.3	331.7
Income taxes.....	(262.1)	0.9	(89.5)	(80.1)
Net (Loss)/Income.....	(369.4)	(86.9)	285.8	251.6

(1) Reflects stand-alone financial information of PTC and Meo, S.A. and does not give effect to intercompany eliminations that would be eliminated in a consolidation of financial information. For the years ended December 31, 2012 and 2011, the net impact of intercompany eliminations between PTC and Meo, S.A. (but not including any other intercompany eliminations) on PTC's revenues would have been to reduce revenues by €160.2 million and €134.2 million, respectively, and on MEO's revenues would have been to reduce revenues by €107.8 million and €45.1 million, respectively. The net impact of intercompany eliminations between PTC and Meo, S.A. on income before depreciation and amortization and net income reflects primarily the equity in earnings of Meo, S.A. recorded by PTC through the equity method of accounting, amounting to €251.6 million and €285.8 million in the year ended December 31, 2012 and 2011, respectively, as the other eliminations offset each other in the operating and financial results. For further details, see "PT Portugal Combined Selected Financial Information—Basis of Presentation".

(2) Meo, S.A. recorded post retirement benefit costs of €0.08 million and €0.04 million in the years ended December 31, 2012 and 2011, respectively, and curtailment costs of €1.1 million in the year ended December 31, 2011, both of which are included under the caption "Other expenses and losses" in Meo, S.A.'s standalone profit and loss statement.

Operating Revenues

PTC's revenues from services rendered and sales decreased by 1.3% to €1,774.3 million in 2012 from €1,796.8 million in 2011. This decrease was primarily due to (i) lower revenues in the enterprise customer category, where we experienced pricing and demand pressure as a result of strong cost-cutting initiatives by government agency clients and a significant reduction in investments in new projects by government agency clients, cost reduction initiatives by large corporations and economic challenges faced by small and medium businesses, which showed some resilience in 2011 but became more negatively affected by the economic and financing conditions in Portugal in 2012 and (ii) lower revenues from wholesale and other businesses, as a result of a decline in the directories business, leased lines and accesses, including lower prices resulting from adverse regulatory decisions and lower volumes as operators continue to build networks, and declines in revenues from public pay phones and the termination of national and international traffic. These decreases in revenues were partially offset by an increase in revenues from the residential customer category, which were driven by the success of the *Meo* double- and triple-play offers. Additionally, PTC's subsidies to operation remained stable at €0.1 million for the years ended December 31, 2011 and 2012, respectively.

Meo, S.A.'s revenues from services rendered and sales decreased by 7.3% to €1,153.3 million in 2012 from €1,244.0 million in 2011. This decrease was primarily due to (i) lower revenues in the Enterprise customer category, where we experienced pricing and demand pressure due to the reasons mentioned above and (ii) revenue declines in the

personal customer category, primarily due to lower mobile interconnection revenues (partially as a result of the negative impact of lower mobile termination rates), lower customer revenues (reflecting the effects of challenging economic conditions that have made customers more price-sensitive, greater competitive pressures, increased popularity of “tribal plans” yielding lower revenues per user, as well as the negative effect of lower revenues from mobile broadband due to the higher popularity of fixed broadband) and lower equipment sales. Notwithstanding the economic environment and significant growth in fixed broadband due to triple-play bundled offers, data revenues accounted for 33.2% of service revenues, an increase of 2.4% over 2011, as a result of the solid performance of “*internetnotemóvel*” (internet on the cell phone) data packages, which continued to show strong growth, the commercial success of our “*e nunca mais acaba*” plan and increased penetration of smartphones, which partially offset the pressure on mobile broadband revenues. Additionally, Meo, S.A.’s subsidies to operation increased to €0.03 million in 2012 from no subsidies to operation in 2011.

Costs and Expenses

Costs of products sold and impairment of inventories. PTC’s costs of products sold decreased by 18.6% to €31.6 million in 2012 from €38.8 million in 2011. This decrease was primarily due to our strict cost control policies. PTC’s impairment reversals of inventories decreased to €3.6 million in 2012 from €6.7 million in 2011. Meo, S.A.’s costs of products sold decreased by 1.7% to €107.4 million in 2012 from €109.3 million in 2011. This decrease was primarily due to lower sales, lower handset subsidies offered to our mobile customers and a lower average cost of handsets as a result of favorable contracts entered into with key suppliers. Meo, S.A.’s impairment reversals of inventories increased to €4.1 million in 2012 from €1.4 million in 2011.

Direct costs. PTC’s direct costs increased by 17.1% to €484.0 million in 2012 from €413.4 million in 2011. This increase is primarily due to an increase in programming costs, driven by customer growth and investment in content for our *Meo* offering, and higher costs associated with international traffic. The increase in direct costs was partially offset by lower costs associated with our directories business. Meo, S.A.’s direct costs decreased by 0.4% to €225.3 million in 2012 from €226.3 million in 2011. This decrease is primarily due to lower mobile traffic costs due to the impact of the regulatory mobile termination rate cuts and lower roaming interconnection costs and lower costs for contents of internet and mobile services. The decrease in direct costs was partially offset by an increase in lease capacity costs to €117.0 million in 2012 from €91.2 million in 2011.

Marketing and publicity. PTC’s marketing and publicity costs decreased by 21.0% to €20.7 million in 2012 from €26.2 million in 2011. Meo, S.A.’s marketing and publicity costs decreased by 20.3% to €23.6 million in 2012 from €29.6 million in 2011. The decrease in PTC’s and Meo, S.A.’s marketing and publicity costs was primarily due to our strict cost control policies and marketing investments already made in previous years. In 2010, PTC and Meo, S.A. began to market their services under one brand, *Meo*, rather than marketing their services under several brands as was the case prior to 2010. This led to the simplification of marketing campaigns and thus the continual reduction in marketing costs as the *Meo* brand became more well known.

Supplies and external services. PTC’s supplies and external services decreased by 6.0% to €445.4 million in 2012 from €474.0 million for the year ended December 31, 2011. This decrease was primarily due to lower maintenance and repair expenses, support services and other third-party services, which benefited from the roll-out of our FTTH network and an extensive field force transformation program. Meo, S.A.’s supplies and external services decreased by 6.3% to €261.9 million in 2012 from €279.6 million for the year ended December 31, 2011. This decrease was primarily due to lower commissions, which was achieved against a backdrop of continued customer growth (thus reflecting lower churn).

Wages and salaries. PTC’s wages and salaries, including employee benefits and social charges, decreased to €235.5 million in 2012 from €240.1 million in 2011, a decrease of 1.9%. Meo, S.A.’s wages and salaries, including employee benefits and social charges, decreased to €44.9 million in 2012 from €48.0 million in 2011, a decrease of 6.5%. The decreases in wages and salaries for PTC and Meo, S.A. are primarily due to lower variable and overtime compensation, higher efficiency levels in certain internal processes and lower personnel costs as a result of a restructuring plan implemented in the fourth quarter of 2011.

Post retirement benefit costs. PTC’s post retirement benefit costs decreased by 4.1% to €51.7 million in 2012 from €53.9 million in 2011. This decrease was primarily due to a decrease in costs related to the annual service of active and suspended employees that were entitled to pension benefits under PTC’s pension plans, which were transferred to the Portuguese State in December 2010. This cost item does not include early termination costs related to our workforce reduction program, which are discussed under “—*Curtailment and settlement costs*” below.

Curtailment and settlement costs. PTC’s curtailment and settlement costs decreased by 97.3% to €0.9 million in 2012 from €32.9 million in 2011, reflecting mainly the reorganization undertaken at the end of 2011 that led to a number of employees becoming pre-retired or suspended and a decrease in the net present value of the salaries payable to such pre-retired or suspended employees.

Indirect taxes. PTC's indirect taxes increased by 11.6% to €15.4 million in 2012 from €13.8 million in 2011. Meo, S.A.'s indirect taxes increased by 2.6% to €15.8 million in 2012 from €15.4 million in 2011. The increase in PTC and Meo, S.A.'s indirect taxes was primarily due to an increase in VAT-related expenses.

Provisions and adjustments. For PTC, provisions and adjustments increased by 50.9% to €33.5 million in 2012 from €22.2 million in 2011, primarily due to an increase in provisions for legal actions and higher provisions for bad debt. For Meo, S.A., provisions and adjustments increased by 195.8% to €11.6 million in 2012 from €2.4 million in 2011, reflecting higher provisions for both bad debt and legal actions.

Net other income and gains/(expenses and losses). PTC's net other income and gains increased to €95.3 million in 2012 from €28.3 million in 2011. This was primarily due to a €60.0 million one-off gain recorded in 2012 relating to compensation received by PTC in connection with its universal service obligations under its concession agreement. Meo, S.A.'s net other expenses and losses increased to €6.1 million in 2012 from €1.0 million in 2011. This was primarily due to certain non-recurring adjustments for accounts receivables recognized in 2012.

Equity in earnings of affiliated companies, net. PTC's equity in earnings of affiliated companies decreased by 21.4% to €120.5 million in 2012 from €153.3 million in 2011, reflecting primarily lower earnings from PTC's equity investment in Meo, S.A. Meo, S.A.'s equity in earnings of affiliated companies increased by 36.4% to €68.6 million in 2012 from €50.3 million in 2011. This increase was predominantly due to higher earnings from Meo, S.A.'s equity investment in PT Móveis, which at that time held the investment in Bratel BV which held the investment in Oi.

Income before depreciation and amortization, financing expenses and taxes. PTC's income before depreciation and amortization, financing expenses and taxes increased by 0.8% to €715.6 million in 2012 from €709.7 million in 2011, primarily due to the non-recurring gain recorded in 2012 relating to the wireline concession agreement included under the caption "Other income and gains", as explained above, which was partially offset by lower services rendered due to the factors detailed above and lower equity in earnings of affiliated companies, reflecting Meo, S.A.'s lower net income. Meo, S.A.'s income before depreciation and amortization, financing expenses and taxes decreased by 9.1% to €533.5 million in 2012 from €587.1 million in 2011, primarily due to a decline in service revenues due to the factors described above, which was partially offset by higher equity in earnings of affiliated companies, reflecting higher earnings at PT Móveis.

Based on the PT Portugal Combined Selected Financial Information, PTC and Meo, S.A. represented over 97.4% and 94.6% of the PT Portugal Group's EBITDA for the years ended December 31, 2012 and 2011, respectively. See "PT Portugal Combined Selected Financial Information". For a reconciliation between income before depreciation and amortization, financing expenses and taxes as reported by PTC and Meo, S.A. under Portuguese GAAP and EBITDA as reported by Portugal Telecom SGPS, S.A., see "—Summary of Significant Differences between Portuguese GAAP and IFRS".

Depreciation and amortization. PTC's depreciation and amortization costs decreased by 3.9% to €497.7 million in 2012 from €518.0 million in 2011. This decrease was primarily due to the ending of the useful life of several real estate assets in December 2011, which also led to lower amortization expenses in 2012. Meo, S.A.'s depreciation and amortization costs decreased by 7.0% to €180.8 million in 2012 from €194.4 million in 2011. This was primarily due to the swap of Meo, S.A.'s 2G equipment for 4G-enabled equipment, which led to the accelerated depreciation of 2G equipment through June 30, 2011.

Net interest and related income (expenses). PTC's net interest and related expenses increased by 2.2% to €305.7 million in 2012 from €299.0 million in 2011. Meo, S.A.'s net interest and related expenses increased by 22.0% to €21.1 million in 2012 from €17.3 million in 2011. The increase in PTC's and Meo, S.A.'s net interest and related expenses primarily reflects higher interest expenses related to intercompany loans, following the increase in outstanding average debt.

Income taxes. For the year ended December 31, 2012, PTC's income tax gain amounted to €0.9 million compared to income taxes of €262.1 million for the year ended December 31, 2011. This was due to the derecognition of deferred tax assets totalling €227.2 million in 2011. For Meo, S.A., income taxes decreased from €89.5 million in 2011 to €80.1 million in 2012, reflecting lower taxable earnings mainly due to the decline in revenues.

Net (Loss)/Income. For PTC, net loss decreased by 75.3% to €86.9 million in 2012, compared to €369.4 million in 2011, as a result of the factors described above. For Meo, S.A., net income decreased by 12.0% to €251.6 million in 2012, compared to €285.8 million in 2011, as a result of the factors described above.

Liquidity and Capital Resources

Our principal capital requirements relate to:

- funding our operations;
- capital expenditures on our network infrastructure, information systems and other investments (see “—*Capital Expenditures*” and “—*Contractual Obligations and Off-Balance Sheet Arrangements*” below);
- funding interest payments with respect to our indebtedness and repayments and refinancing of our indebtedness (see “—*Indebtedness*” below);
- in prior periods, shareholder remuneration in the form of dividend payments; and
- funding of post retirement benefits (see “—*Post Retirement Benefits*” below).

Our principal sources of funding for these capital requirements were cash generated from our operations and from the Group and equity and debt financing. We believe that our cash balances, together with the cash that we expect to generate from our operations and available liquidity under our credit facilities and lines of credit, are currently sufficient to meet our present funding needs. Following the New Transactions, liquidity will be provided by the Existing Revolving Credit Facilities and the New Revolving Credit Facilities and other resources within the Altice International Group. For the liquidity and capital resources of the Altice International Group, see “*Management’s Discussion and Analysis of Financial Condition and Results of Operations of the Group—Liquidity and Capital Resources*”.

Cash Flows

The table below sets forth a breakdown of PTC’s and Meo, S.A.’s cash flows for the years ended December 31, 2011, 2012 and 2013 and the nine-month periods ended September 30, 2013 and 2014.⁽¹⁾

	PTC					Meo, S.A.				
	Year ended December 31,			Nine months ended		Year ended December 31,			Nine months ended	
	2011	2012	2013	2013	2014	2011	2012	2013	2013	2014
	€ in millions									
Cash and cash equivalents at the beginning of the period.....	2.9	55.2	21.2	21.2	21.7	11.4	52.8	7.8	7.8	10.3
Merger of PT Prime.....	7.8	—	—	—	—	—	—	—	—	—
Cash flow from operating activities	578.7	543.8	488.8	396.6	484.2	476.0	432.6	259.8	194.0	189.2
Cash flow from (used in) investing activities.....	(403.5)	(296.9)	(33.4)	62.2	(218.6)	(153.0)	(281.5)	(78.1)	(34.9)	131.7
Cash flow from (used in) financing activities	(131.2)	(280.8)	(453.0)	(429.5)	(233.2)	(281.7)	(196.1)	(179.2)	(127.3)	(252.5)
Effect of exchange differences	0.5	(0.03)	(1.9)	—	0.7	—	—	—	—	—
Cash and cash equivalents at end of year.....	55.2	21.2	21.7	49.5	54.9	52.8	7.8	10.3	39.6	78.6

(1) Reflects stand-alone financial information of PTC and Meo, S.A. and does not give effect to intercompany eliminations that would be eliminated in a consolidation of financial information. The relevant intercompany eliminations between PTC and Meo, S.A. relating to operating activities result from: (1) PTC’s net cash receipts from Meo, S.A. relating to operating activities amounting to €94.4 million and €78.9 million for the nine months ended September 30, 2013 and 2014, respectively, and €134.5 million, €105.3 million and €138.2 million for the years ended December 31, 2011, 2012 and 2013, respectively, and (2) Meo, S.A.’s net cash payments to PTC relating to operating activities amounted to the same amounts referred to above. The relevant intercompany eliminations between PTC and Meo, S.A. relating to investing activities and financing activities result from: (1) PTC’s cash inflow from the repayment by Meo, S.A. of intercompany loans that had been granted by PTC in previous years, amounting to €340.0 million for the nine months ended September 30, 2013 and €160.0 million for the year ended December 31, 2011, and interest received by PTC in connection with these loans amounting to €30.0 million for the year ended December 31, 2013, and (2) MEO’s net cash payments to PTC relating to these same loans, which are included under financing activities and amounted to the same amounts referred to above. For further details, see “*PT Portugal Combined Selected Financial Information—Basis of Presentation*”.

Cash Flow from Operating Activities

Cash flows from operating activities include collections from customers, payments to suppliers, payments to employees, payments relating to income taxes, payments related to post retirement benefits and other cash payments made with respect to operating activities.

PTC's net cash flow from operating activities increased by 22.1% to €484.2 million for the nine months ended September 30, 2014 from €396.6 million for the nine months ended September 30, 2013, primarily due to lower payments to suppliers, which was partially offset by lower cash receipts from customers, both reflecting the decreased commercial activity at PTC.

Meo, S.A.'s net cash flow from operating activities decreased by 2.5% to €189.2 million for the nine months ended September 30, 2014 from €194.0 million for the nine months ended September 30, 2013, primarily due to lower cash receipts from customers which was partially offset by lower payments to suppliers and lower payments of income taxes.

PTC's net cash flow from operating activities decreased by 10.1% to €488.8 million in 2013 from €543.8 million in 2012, primarily due to lower collections from customers (with a decrease of €170.6 million), reflecting the decline in revenues, and higher income taxes paid by PTC for the year ended December 31, 2013 as compared to the year ended December 31, 2012 from a cash receipt of €35.9 million in 2012 to a payment of €6.3 million in 2013. These effects were partially offset by lower payments relating to post retirement benefits (with a decrease of €7.5 million), lower payments to suppliers (with a decrease of €144.2 million) due to lower operating costs in line with the decline in revenues and lower payments to employees (with a decrease of €13.3 million).

Meo, S.A.'s net cash flow from operating activities decreased by 39.9% to €259.8 million in 2013 from €432.6 million in 2012, primarily due to lower collections from customers (with a decrease of €200.2 million), reflecting the decline in revenues, and an increase in payments relating to other operating activities, reflecting mainly spectrum fees and other payments, including the payments of certain indirect taxes and payments relating to legal actions. These were partially offset by lower payments to suppliers (with a decrease of €18.6 million) and employees (with a decrease of €2.4 million) and a decrease in income tax payments to €69.9 million in 2013 from €92.1 million in 2012.

PTC's net cash flow from operating activities decreased by 6.0% to €543.8 million in 2012 from €578.7 million in 2011, primarily due to higher payments to suppliers (with an increase of €91.8 million), reflecting higher direct costs, and an increase in other cash payments made to €94.3 million in 2012 from €47.5 million in 2011. These were partially offset by a decrease in income tax paid for the year ended December 31, 2012 as compared to the year ended December 31, 2011 from a cash payment of €52.2 million in 2011 to a cash receipt of €35.9 million in 2012.

Meo, S.A.'s net cash flow from operating activities decreased by 9.1% to €432.6 million in 2012 from €476.0 million in 2011, primarily due to lower collections from customers (with a decrease of €32.6 million), reflecting the decline in revenues, an increase in income tax payments to €92.1 million in 2012 from €83.6 million in 2011 and an increase in payments to suppliers to €765.6 million in 2012 from €762.0 million in 2011, partially offset by a decrease in payments to employees to €48.7 million in 2012 from €48.9 million in 2011 and a decrease in VAT payments and spectrum fees paid to ANACOM to €85.8 million in 2012 from €87.0 million in 2011.

Cash Flow from (Used in) Investing Activities

Cash flows from investing activities include proceeds from disposals of investments in affiliated companies and property, plant and equipment, loans granted, dividends, as well as interest and related income on cash equivalents and short-term investments. Cash flows used in investing activities primarily include capital expenditures on tangible and intangible assets, investments in other companies and expenditures on loans granted.

PTC's net cash flow used in investing activities increased to €218.6 million for the nine months ended September 30, 2014 from a net cash receipt of €62.2 million for the nine months ended September 30, 2013, primarily due to the repayment in 2013 by Meo, S.A. to PTC of an intercompany loan that had been granted by PTC in previous years, amounting to €340.0 million. This was partially offset by lower payments to fixed asset suppliers, reflecting the decline in capital expenditures.

Meo, S.A.'s net cash flow from investing activities increased to €131.7 million for the nine months ended September 30, 2014 from net cash flow used in investing activities of €34.9 million for the nine months ended September 30, 2013, primarily due to higher dividends received from PT Móveis (which amounted to €194.0 million for the nine months ended September 30, 2014 as compared to €67.9 million for the nine months ended September 30, 2013) and lower payments to fixed asset suppliers (€33.9 million), reflecting the decline in capital expenditures. There was a cash payment of €6.0 million in each of January 2013 and January 2014, representing the second and third instalments (out of a total of six instalments) for the 4G license which Meo, S.A. acquired in 2011.

PTC's net cash flow used in investing activities decreased by 88.8% to €33.4 million in 2013 from €296.9 million in 2012, primarily due to a decrease in cash payments for the acquisition of tangible assets to €399.1 million in 2013 from €531.2 million in 2012 (primarily due to lower capital expenditures as a result of investments in its FTTH network in prior years), an increase in cash receipts from the disposals of financial investments (primarily resulting from the disposal of the investment in Companhia de Telecomunicações de Macau, S.A.R.L. for €36.0 million in 2013) and the cash

receipt relating to loans granted in prior years to Meo, S.A. (€340 million). These were partially offset by the dividend of €235.5 million received from Meo, S.A. in 2012 and an increase in payments resulting from financial investments, primarily due to the acquisition of Sportinveste Multimédia in 2013 (€32.6 million).

Meo, S.A.'s net cash flow used in investing activities decreased by 72.3% to €78.1 million in 2013 from €281.5 million in 2012, primarily due to an increase in dividends received from PT Móveis for the year ended December 31, 2013 as compared to the year ended December 31, 2012 to €67.9 million in 2013 from €5.0 million in 2012 and a decrease in cash payments for the acquisition of tangible and intangible assets to €149.2 million in 2013 from €292.6 million in 2012, primarily as a result of the payment in January 2012 of the first instalment of €83.0 million for the 4G license (as compared to a payment of €6.0 million in January 2013 of the secondment instalment for the 4G license) and lower capital expenditures.

PTC's net cash flow used in investing activities decreased by 26.4% to €296.9 million in 2012 from €403.5 million in 2011. This decrease can primarily be attributed to the dividend in an amount of €235.5 million received from Meo, S.A. in 2012 and a decrease in cash payments for the acquisition of tangible assets to €531.2 million in 2012 from €559.7 million in 2011. These were partially offset by the cash receipts in 2011 from loans repaid by Meo, S.A. to PTC in an amount of €160.0 million, which had been granted in previous years.

Meo, S.A.'s net cash flow used in investing activities increased by 84.0% to €281.5 million in 2012 from €153.0 million in 2011, primarily due to an increase in cash payments for the acquisition of tangible and intangible assets to €292.6 million in 2012 from €167.7 million in 2011 mainly as a result of the payment in January 2012 of the first instalment of €83.0 million for the 4G license, which Meo, S.A. acquired in 2011 and the investments in 4G coverage undertaken throughout 2012. This was partially offset by the dividend of €5.0 million received from PT Móveis in 2012.

Cash Flows from (Used In) Financing Activities

Cash flows used in financing activities include repayments of debt and payments of interest on debt. Cash flows from financing activities primarily consist of borrowings and subsidies.

PTC's net cash flow used in financing activities decreased 45.7% to €233.2 million for the nine months ended September 30, 2014 from €429.5 million for the nine months ended September 30, 2013, primarily due to net cash receipts from loans obtained of €82.1 million for the nine months ended September 30, 2014, as compared to net payments resulting from loans repaid of €226.7 million for the nine months ended September 30, 2013. This was partially offset by an increase of €111.6 million in interest payments, reflecting the increase in the total debt of PTC.

Meo, S.A.'s net cash flow used in financing activities increased by 98.4% to €252.5 million for the nine months ended September 30, 2014 from €127.3 million for the nine months ended September 30, 2013, primarily due to higher net payments from loans repaid, totaling €243.9 million and €116.1 million for the nine months ended September 30, 2014 and 2013, respectively.

PTC's net cash flow used in financing activities increased by 61.3% to €453.0 million in 2013 from €280.8 million in 2012, primarily due to an increase in cash payments under the commercial paper programs to €592.0 million in 2013 from a cash receipt of €1,092.0 million in 2012. This was partially offset by an increase in cash receipts obtained under loans granted by PT Portugal and intercompany loans amounting to €476.4 million in 2013 compared to a payment of €472.2 million under intercompany loans in 2012, a payment in 2012 to the Portuguese Social Security System relating to the transfer of unfunded regulatory pension obligations to the Portuguese State amounting to €454.3 million and a decrease in interest payments and related expenses to €321.0 million in 2013 from €426.2 million in 2012.

Meo, S.A.'s net cash flow used in financing activities decreased by 8.6% to €179.2 million in 2013 from €196.1 million in 2012. This decrease can primarily be attributed to the dividend payments of €235.5 million made to PTC in 2012 and the cash receipt of €250.0 million from loans obtained in 2013, primarily due to receipts obtained under the commercial paper programs. These were partially offset by the repayment in 2013 of loans owing to PTC (€340.0 million), the increase in payments relating to intercompany loans to €46.2 million in 2013 from a cash receipt of €47.0 million in 2012 and the increase in interest payments and related expenses to €42.9 million in 2013 from €5.2 million in 2012.

PTC's net cash flow used in financing activities increased by 114.0% to €280.8 million in 2012 from €131.2 million in 2011, primarily due to an increase in payments relating to leases and other loans obtained to €21.4 million in 2012 from €12.9 million in 2011, an increase in payments relating to intercompany loans to €472.2 million in 2012 from a cash receipt of €4.8 million in 2011, a decrease in cash receipts from loans granted by PT Portugal to no cash receipts in 2012 from €727.0 million in 2011 and an increase in interest payments and related expenses to €426.2 million in 2012 from €155.8 million in 2011. These were partially offset by an increase in cash receipts obtained under the commercial paper programs to €1,092.0 million in 2012 from a payment of €227.0 million in 2011 and a decrease in payments to the Portuguese Social Security System relating to the transfer of unfunded regulatory pension obligations to the Portuguese

State for the year ended December 31, 2012 as compared to the year ended December 31, 2011 to €454.3 million in 2012 from €467.4 million in 2011.

Meo, S.A.'s net cash flow used in financing activities decreased by 30.4% to €196.1 million in 2012 from €281.7 million in 2011, primarily due to a decrease in payments related to loans obtained to a receipt of €44.6 million in 2012 from a payment of €268.2 million in 2011. This decrease can primarily be attributed to a decrease in payments relating to financing under the centralized treasury system, to a cash receipt of €47.0 million in 2012 from a payment of €52.8 million in 2011, a decrease in repayments of financing obtained under the commercial paper program and shareholders' loans to no repayments in 2012 from €209.9 million in 2011 and a decrease in payments under finance lease contracts and other financing to €2.5 million in 2012 from €5.5 million in 2011. These were partially offset by the dividends of €235.5 million which was paid to PTC in 2012.

Working Capital

The working capital requirements of PTC correspond principally to the value of the stocks (composed mainly of end user equipment), the increase in trade accounts receivable and other receivables and decrease in trade accounts payable and other payables. The working capital requirements of Meo, S.A. correspond principally to the value of the stocks (composed mainly of mobile handsets, boxes, decoders and accessories), the increase in trade accounts receivable and other receivables and decrease in trade accounts payable and other payables.

With respect to the B2C market PTC and Meo, S.A. generate working capital in connection with the shorter client payment periods (generally 30 days) than those of the suppliers (generally between 60 and 90 days), while with respect to the enterprise and wholesale market, PTC and Meo, S.A. are higher since clients in these markets benefit from longer payment periods.

The change in working capital requirements of PTC can be broken down as follows:

	Year ended December,		Nine Months ended September 30,	
	2012	2013	2013	2014
	€ in millions			
<i>Accounts receivable</i>	(114.2)	3.4	6.9	6.2
<i>Accounts payable</i>	162.2	(65.1)	(25.1)	(73.5)
<i>Inventories</i>	(5.2)	(18.2)	(6.2)	1.1
<i>Tax Receivable/(Payable)</i>	(8.0)	12.3	(12.5)	(21.9)
<i>Accrued Expenses</i>	57.9	11.5	(58.7)	(10.4)
<i>Deferred Income</i>	(7.8)	(17.7)	(10.4)	(1.5)
<i>Prepaid expenses</i>	0.3	0.5	3.5	2.9
Change in working capital requirements	85.3	(74.4)	(102.6)	(97.1)

The change in working capital requirements of Meo, S.A. can be broken down as follows:

	Year ended December,		Nine Months ended September 30,	
	2012	2013	2013	2014
	€ in millions			
<i>Accounts receivable</i>	(22.7)	17.4	31.5	141.9
<i>Accounts payable</i>	101.9	103.5	63.1	(7.0)
<i>Inventories</i>	(5.5)	3.8	15.5	(5.8)
<i>Tax Receivable/(Payable)</i>	1.4	(15.6)	(7.0)	3.6
<i>Accrued Expenses</i>	14.4	(33.5)	(27.8)	(8.5)
<i>Deferred Income</i>	2.5	10.8	8.8	3.2
<i>Prepaid expenses</i>	2.9	(2.1)	0.9	4.8
Change in working capital requirements	94.9	84.4	85.1	132.1

For the nine months ended September 30, 2014, the divestment in working capital of PTC resulted in a cash contribution of €97.1 million. This change is principally due to an increase in trade payables, including primarily an increase in payables to Meo, S.A., and the Christmas subsidy that is accrued through the year and paid in the fourth quarter of each year. For the nine months ended September 30, 2014, the investment in working capital of Meo, S.A. generated a cash requirement of €132.1 million. This change is principally due to higher trade receivables, including intercompany receivables, namely from PTC.

For the year ended December 31, 2013, the divestment in working capital of PTC resulted in a cash contribution of €74.4 million. This change is principally due to an increase in trade payables, including intercompany payables to other entities of PT Portugal group. For the year ended December 31, 2013, the investment in working capital requirements of Meo, S.A. generated a cash requirement of €84.4 million. This change is principally due lower accounts payables.

We expect our operating cash flows and, if required, available borrowings under the Altice Group's revolving credit facilities will be sufficient to meet our working capital requirements during the next twelve months.

Capital Expenditures

The following tables set forth the accrued capital expenditures of the PT Portugal Group by entity and by segment based on the PT Portugal Combined Selected Financial Information:

	Year ended December 31,			Nine months ended September 30,	
	2011	2012	2013	2013	2014
	€ in millions				
PTC	515.3	392.8	341.1	229.3	170.7
Meo, S.A.	280.1	140.8	107.5	70.2	42.3
Sub-total	795.4	533.6	448.6	299.5	213.0
Other entities included in the transaction perimeter	3.2	38.1	71.7	56.8	18.0
Total combined capex	798.6	571.7	520.3	356.3	231.0

	Year ended December 31,		Nine months ended September 30,	
	2012	2013	2013	2014
	€ in millions			
Customer	180.2	158.7	119.7	98.5
B2C	123.4	98.9	73.2	67.7
B2B	55.0	57.6	45.1	29.4
Other	1.8	2.1	1.4	1.4
Infrastructure	266.1	199.3	121.7	75.7
IT/IS	90.5	110.8	88.6	40.7
Other	18.6	21.2	6.6	6.2
Telecommunications business	555.5	490.0	336.7	221.1
Support companies and other entities	16.2	30.3	19.6	9.9
Total combined capex	571.7	520.3	356.3	231.0

For the nine months ended September 30, 2014, total capital expenditures of PTC and Meo, S.A. decreased by 28.9% to €213.0 million from €299.5 million for the nine months ended September 30, 2013, as a result of significant investments made in the past years, both in FTTH and 4G-LTE. For the nine months ended September 30, 2014 and 2013, PT Portugal Group's combined capital expenditures, as derived from the PT Portugal Combined Selected Financial Information, amounted to €231.0 million and €356.3 million, respectively, and PTC and Meo, S.A. accounted for 92.2% and 84.1% of the combined capital expenditures, respectively.

The decrease in total capital expenditures of PTC and Meo, S.A. to €448.6 million in 2013 from €533.6 million in 2012 reflects declines in both customer and infrastructure capital expenditures. The decline in customer capital expenditures was primarily explained by (1) lower unitary equipment costs, (2) lower net additions of customers and (3) lower churn across our pay-TV and broadband services. In 2013, the decline in infrastructure capital expenditures was primarily explained by our expenditures in previous years to (i) deploy the FTTH network, (2) modernize the 4G- enabled 2G network and (3) reinforce our 3G and 3.5G networks in terms of coverage and capacity. This led to an overall decrease in technology capital expenditures in 2013, notwithstanding our investments in deploying the 4G network. For the years ended December 31, 2013 and 2012, PT Portugal Group's combined capital expenditures, as derived from the PT Portugal Combined Selected Financial Information, amounted to €520.3 million and €571.7 million, respectively, and PTC and Meo, S.A. accounted for 86.2% and 93.3% of the combined capital expenditures, respectively.

The table below sets forth the cash capital expenditures of the PT Portugal Group by entity based on the PT Portugal Combined Selected Financial Information:

	For the year ended December 31,			For the nine months ended September 30,	
	2011	2012	2013	2013	2014
	€ millions				
PTC					
Capex for Tangible Assets	559.7	531.2	399.1	307.4	258.2
Capex for Intangible Assets	10.3	7.8	8.8	7.5	4.7
Gross Capex	570.0	539.0	407.9	314.9	262.9
Cash Receipts from Tangible and Intangible Assets	(3.2)	(3.7)	(6.1)	(5.2)	(49.6)
Net Cash Capex	566.8	535.3	401.8	309.7	213.3
Meo, S.A.					
Capex for Tangible Assets	115.2	163.2	126.4	90.0	54.8
Capex for Intangible Assets	52.5	129.4	22.8	15.1	16.4
Gross Capex	167.7	292.6	149.2	105.1	71.2
Cash Receipts from Tangible and Intangible Assets	(6.9)	(2.7)	(1.1)	(0.8)	(7.6)
Net Cash Capex	160.8	289.9	148.1	104.3	63.6
Other entities included in the transaction perimeter					
Capex for Tangible Assets	7.4	18.9	58.3	51.0	14.8
Capex for Intangible Assets	2.1	1.0	1.7	0.8	4.4
Gross Capex	9.5	19.9	60.0	51.8	19.2
Cash Receipts from Tangible and Intangible Assets	(0.3)	(0.2)	(0.6)	(0.5)	(0.7)
Net Cash Capex	9.2	19.7	59.4	51.3	18.5
Eliminations					
Capex for Tangible Assets	(77.1)	(87.8)	(57.0)	(43.6)	(36.8)
Capex for Intangible Assets					
Gross Capex	(77.1)	(87.8)	(57.0)	(43.6)	(36.8)
Cash Receipts from Tangible & Intangible Assets	—	—	—	—	52.3
Net Cash Capex	(77.1)	(87.8)	(57.0)	(43.6)	15.5
Total					
Capex for Tangible Assets	605.2	625.5	526.7	404.8	291.0
Capex for Intangible Assets	64.9	138.1	33.3	23.3	25.4
Consolidated Gross Cash Capex.....	670.1	763.6	560.0	428.1	316.4
Cash Receipts from Tangible & Intangible Assets	(10.3)	(6.5)	(7.7)	(6.4)	(5.6)
Consolidated Net Cash Capex.....	659.8	757.1	552.3	421.7	310.8

The difference between the cash capital expenditures and accrued capital expenditures of the PT Portugal Group is primarily due to the trend of declining accrued capital expenditures over such periods and the timing of when capital expenditures are paid. For example (and based on the general assumption of a 90-day payment period): (i) consolidated gross cash capital expenditures of the PT Portugal Group for the nine months ended September 30, 2014 are €85.4 million greater than the accrued capital expenditures of the PT Portugal Group, reflecting higher accrued capital expenditures in the fourth quarter of 2013 of €164 million, which was paid in the first quarter of 2014, as compared to accrued capital expenditures of €67 million in the third quarter of 2014, which was paid in the fourth quarter of 2014, (ii) consolidated gross cash capital expenditures of the PT Portugal Group for the nine months ended September 2013 are €71.8 million greater than the accrued capital expenditures of the PT Portugal Group, reflecting higher accrued capital expenditures in the fourth quarter of 2012 of €191.9 million, which was paid in the first quarter of 2012 (including a €83 million instalment payment for the 4G license acquired by Meo, S.A. in 2011, that had been recorded as capex in the fourth quarter of 2011 for a total of €106 million), as compared to accrued capital expenditures of €117 million in the third quarter of 2013, which was paid in the fourth quarter of 2013, (iii) consolidated gross cash capital expenditures of the PT Portugal Group for the year ended December 31, 2012 are €192 million greater than the accrued capital expenditures of the PT Portugal Group, reflecting higher accrued capital expenditures in the fourth quarter of 2011 of €387 million, which was paid in the first quarter of 2012, as compared to accrued capital expenditures of €195 million in the fourth quarter of 2012 (including a €83 million instalment payment for the 4G license acquired by Meo, S.A. in 2011, that had been recorded as capex in the fourth quarter of 2011 for a total amount of €106 million), which was paid in the first quarter of 2013 and (iv) consolidated gross cash capital expenditures of the PT Portugal Group for the year ended December 31, 2011 are €128.5 million less than the accrued capital expenditures of the PT Portugal Group, reflecting the increase of capital expenditures from 2010 to 2011.

Indebtedness

PTC's indebtedness amounted to €7,318.0 million as of September 30, 2014, compared to €7,240.3 million as of December 31, 2013. PTC's cash and cash equivalents increased to € 54.9 million as of September 30, 2014 from €21.7 million as of December 31, 2013. Meo, S.A.'s indebtedness amounted to € 3.1 million as of September 30, 2014, compared to €254.7 million as of December 31, 2013. Meo, S.A.'s cash and cash equivalents increased to €78.6 million

as of September 30, 2014 from €10.3 million as of December 31, 2013. PTC's and Meo, S.A.'s existing debt will be refinanced in connection with the New Transactions. As part of the New Transactions, the Senior Notes Issuer will issue the New Senior Notes, the Senior Secured Notes Issuer will issue the New Senior Secured Notes and enter into the New Revolving Credit Facilities and Altice S.A. will issue the New ASA Senior Notes. The Senior Secured Notes Issuer will use amounts borrowed under the New Senior Notes Proceeds Loan, the proceeds of the offering of the New Senior Secured Notes, amounts borrowed under the New Term Loan and any amounts borrowed under the New Super Senior Revolving Credit Facility to make a proceeds loan (the "New AH Proceeds Loan") to Altice Holdings. Altice Holdings will use the proceeds under the New AH Proceeds Loan and the ASA Notes Proceeds Contribution to make the AWE Proceeds Loan to Altice West Europe which in turn will make the AP Proceeds Loan to Altice Portugal to consummate the PT Portugal Acquisition. Furthermore, Altice Portugal, PT Portugal, PTC, Meo, S.A., PT Móveis and SIRESP intend to enter into the PT Group Loans as part of the PT Portugal Acquisition. Following the completion of the New Transactions, PT OpCo will have €969.9 million of debt comprising intercompany loans from PT Portugal.

In addition, as of September 30, 2014, PTC had €27.2 million of debt under finance leases of which €15.9 million is due within one year, €5.4 million is due between one and three years, €4.2 million is due between three and five years and €1.7 million is due in more than five years.

As of September 30, 2014, Meo, S.A. had €3.1 million of debt under finance leases of which €1.4 million is due within one year, €0.8 million is due between one and three years, €0.5 million is due between three and five years and €0.3 million is due in more than five years. In addition, the other subsidiaries in the PT Portugal Group (excluding PTC and Meo, S.A.) had €13.3 million of debt under finance leases, as derived from the PT Portugal Combined Selected Financial Information, as of September 30, 2014.

Post Retirement Benefits

As of December 31, 2013, the projected benefits obligations, or PBO, of PTC's post retirement benefits, including pension supplements, healthcare benefits and salaries payable to pre-retired and suspended employees amounted to €1,328.3 million (€116.4 million for pension supplements, €375.7 million for healthcare benefits and €836.3 million for salaries payable to pre-retired and suspended employees). As of September 30, 2014, the projected benefits obligations, or PBO, of PTC's post retirement benefits, including pension supplements, healthcare benefits and salaries payable to pre-retired and suspended employees amounted to €1,316.4 million (€112.9 million for pension supplements, €402.0 million for healthcare benefits and €801.5 million for salaries payable to pre-retired and suspended employees). The decrease in the PBO of PTC's post retirement benefits was primarily due to the decrease in salaries payable to pre-retired and suspended employees, which was partially offset by the increase in healthcare benefits obligations due to net actuarial losses recorded as a result of the reduction in discount rates that was partially offset by a gain recorded as a result of the reduction in benefits granted under these plans. As of September 30, 2014 and December 31, 2013, these projected benefits obligations were computed based on discount rates of 2.00% and 3.00% for pension supplements, respectively, 2.5% and 4.00% for healthcare benefits, respectively, and 0.75% and 2.00% for obligations related to the payment of salaries to pre-retired and suspended employees, respectively, and assuming an annual salary increase of 1.75% for pension supplements and healthcare benefits and an annual salary increase ranging between 0% and 1% for salaries due to pre-retired and suspended employees, depending on the amount of the salary and the year of payment, as explained in more detail in Note 11.1 to the Audited Financial Statements of PTC for the year ended December 31, 2013. As of December 31, 2013, PTC's post retirement benefits plans which are closed to new participants, covered approximately 19,763 employees in the case of pensions (approximately 36% still in service), approximately 23,402 beneficiaries in the case of healthcare obligations (approximately 23% still in service) and approximately 5,304 suspended and pre-retired employees in the case of salaries obligations. As of December 31, 2013 and September 30, 2014, the PBO of Meo, S.A.'s post retirement benefits, consisting of salaries payable to pre-retired and suspended employees amounted to €5.8 million and €5.2 million, respectively.

According to the rules of the Portuguese Insurance Institute (*Instituto de Seguros de Portugal, or ISPortugal*), the Portuguese insurance regulator, the liability related to retired employees under the pension supplement plans must be fully funded. Under current rules, funding of pension funds for pre-retired employees and employees still in service can be completed up to the retirement age. The estimated average working life of employees still in service is 14 years. As of September 30, 2014, PTC's pension obligations for retired employees, computed based on ISPortugal rules, are fully funded.

In Portugal, there is no legislation on the establishment of funds to cover the healthcare obligations and the salaries for pre-retired and suspended employees. PTC is required to pay for these benefits only when the salaries are paid to pre-retired and suspended employees, or when healthcare expenses are incurred. Accordingly, there is no requirement to fund these benefits obligations at present. However, the Group has set up a fund managed by our subsidiary, PT Prestações, to finance its healthcare post-retirement liabilities. In previous years, the Group contributed €602 million to this fund, which is being managed in accordance with the same guidelines as the Group's pension funds. Since 2010, PTC has not made additional contributions to this fund.

The market value of the pension supplement funds amounted to €94.7 million as of December 31, 2013, a decrease from €99.5 million as of December 31, 2012, reflecting payments of pension supplements made by the funds (€9.0 million). This was partially offset by the positive performance of assets under management (€3.7 million). See Note 14.1 to the Audited Financial Statements of PTC for the year ended December 31, 2013 for additional information. The asset allocation of our pension supplement funds as of December 31, 2013 was 20.4% equity, 60.5% bonds, 2.4% property and 16.6% cash and others. The effective return of the funds in 2013 was approximately 3.7%. As of September 30, 2014, the market value of the pension supplement funds remained broadly stable at €94.2 million, as compared to €94.7 million as of December 31, 2013. The asset allocation of our pension supplement funds as of September 30, 2014 was 23.3% equity, 65.1% bonds, 2.5% property and 9.1% cash and others. The effective return of the funds for the nine months ended September 30, 2014 was approximately 2%.

The market value of the healthcare benefits fund amounted to €291.7 million as of December 31, 2013, a decrease from €299.9 million as of December 31, 2012, reflecting net refunds of healthcare expenses paid on account by PTC (€22.0 million). This was partially offset by the positive performance of assets under management (€13.8 million). See Note 14.2 to the Audited Financial Statements of PTC for the year ended December 31, 2013 for additional information. The asset allocation of our healthcare benefits fund as of December 31, 2013 was 30.0% equity, 19.7% bonds and 50.3% cash and others. The effective return of the funds in 2013 was approximately 4.7%. As of September 30, 2014, the market value of the healthcare benefit funds amounted to €158.5 million, a decrease of €133.2 million from €291.7 million as of December 31, 2013, reflecting primarily the depreciation of the investment in shares of Banco Espírito Santo Bank (“BES”), following the corporate restructuring of this bank, through which the former shareholders of BES became shareholders of an entity that include assets unrelated to the bank’s activities and with no market quote. The asset allocation of our healthcare benefit funds as of September 30, 2014 was 100% cash and others. The effective return of the funds for the nine months ended September 30, 2014 was negative by approximately 40% reflecting the abovementioned depreciation in the investment of BES.

Liabilities stated in PTC’s balance sheet correspond to the difference between the PBO related to pensions deducted from the fair value of pension fund assets. The accrued liability related to PTC’s total post-retirement benefits amounted to €942.0 million as of December 31, 2013. In 2013, the accrued liabilities increased by €112.9 million, reflecting primarily total post retirement benefits and curtailment costs (€128.5 million) and net actuarial losses (€138.8 million) recognized in the period, effects that were partially offset by salary payments to suspended and pre-retired employees up to retirement age made during the year (€156.4 million). The accrued liability related to PTC’s total post-retirement benefits amounted to €1,063.7 million as of September 30, 2014, an increase of €121.7 million from December 31, 2013, reflecting primarily net actuarial losses of €248.5 million due to the reduction in discount rates and negative return on plan assets, which was partially offset by payments, contributions and refunds of €121.2 million, related primarily to salaries paid to pre-retired and suspended employees. The accrued liability related to Meo, S.A.’s salary payments obligations to suspended and pre-retired employees amounted to €5.8 million and €5.2 million as of December 31, 2013 and September 30, 2014.

The table below shows the evolution of PTC’s total net responsibilities for post retirement benefits during the years ended December 31, 2011, 2012 and 2013 and for the nine months ended September 30, 2014.

	2011	2012	2013	September 30, 2014
	€ in millions			
Responsibilities for post retirement benefits, net (initial balance).....	945.6	908.2	829.1	942.0
PT Prime merger.....	0.3	—	—	—
Net periodic pension cost/(gain).....	35.7	35.0	18.5	16.5
Workforce reduction costs.....	31.2	(0.3)	110.0	(22.0)
Payments, contributions and refunds.....	(171.0)	(159.4)	(154.4)	(121.2)
Net actuarial losses (gains).....	66.4	45.6	138.8	248.5
Responsibilities for post retirement benefits, net (final balance).....	908.2	829.1	942.0	1,063.7

The table below sets forth the components of PTC’s cash flows associated with post retirement benefits in 2011, 2012 and 2013 and for the nine months ended September 30, 2014.

	Year Ended December 31,			Nine months ended
	2011	2012	2013	September 30, 2014
	€ in millions			
Pensions				
Contributions to the funds.....	1.7	1.1	0.5	1.1
Payments of pension supplements.....	1.1	1.0	0.8	0.7

Subtotal	2.8	2.1	1.3	1.8
Healthcare				
Refunds	(23.3)	(20.8)	(22.0)	(11.5)
Payments of health care expenses	18.0	19.0	18.8	15.1
Subtotal	(5.3)	(1.8)	(3.2)	3.6
Other payments				
Payments of salaries to pre-retired and suspended employees.....	173.5	159.2	156.4	115.8
Termination payments	1.7	1.5	2.8	0.1
Service cost related to liabilities transferred to the Portuguese State ⁽¹⁾	21.8	25.5	21.8	14.8
Subtotal	197.0	186.1	180.9	130.7
	194.5	186.4	178.9	136.1

(1) This caption is accounted for below EBITDA corresponds to a fixed contribution paid by PTC to the Portuguese Social Security System relating to the annual service of active and suspended employees that were entitled to pension benefits under PTC's post-retirement benefit plans that were transferred to the Portuguese State in December 2010. These contributions are payable so long as the employee who was part of the plans transferred in question remains employed by PTC.

The table below sets forth the estimate of future undiscounted payments as of December 30, 2013, to be made by PTC related to salaries due to pre-retired and suspended employees and to expected contributions to the funds:⁽¹⁾

	€ in millions
2014 (full year)	155.2
2015 and 2016	268.5
2017 and 2018	216.6
More than 5 years	394.5
Total	1,034.8

(1) The figures shown do not take into account payments of salaries to pre-retired and suspended employees that left the company after December 31, 2013 in connection with a redundancy program. During the nine months ended September 30, 2014, we undertook a redundancy program that increased the number of suspended and pre-retired employees by approximately 70.

As of September 30, 2014, the accrued liability related to the PT Portugal Group's total post-retirement benefits amounted to €1,071.8 million, as compared to €1,063.7 million for PTC and €5.2 million for Meo, S.A. This difference is due to salary payments obligations to suspended and pre-retired employees up to retirement age recorded at the other Portuguese subsidiaries in the PT Portugal Group, which amounted to €2.9 million as of September 30, 2014.

Contractual Obligations and Off-Balance Sheet Arrangements

Contractual Obligations and Commercial Commitments

The following table presents PTC's and Meo, S.A.'s contractual obligations and commercial commitments as of September 30, 2014 (other than debt obligations, finance leases and post-retirement benefits discussed above):

PTC:	Payments due by period				Total
	Less than 1 year	1 - 3 years	3 - 5 years	More than 5 years	
	€ in millions				
Contractual obligations:					
Purchase commitments ⁽²⁾	38.4	—	—	—	38.4
Operating lease obligations ⁽³⁾	21.5	6.9	4.0	3.2	35.6
Total contractual cash obligations	59.9	6.9	4.0	3.2	74.0
Meo, S.A.					
Contractual obligations:					
Licenses and concessions ⁽¹⁾	6.0	5.9	10.1	—	22.0
Purchase commitments ⁽²⁾	20.3	—	—	—	20.3
Operating lease obligations ⁽³⁾	21.7	22.6	17.6	19.2	81.1
Total contractual cash obligations	48.0	28.5	27.7	19.2	101.4

(1) Licenses and concessions refer to outstanding instalments due to ANACOM in connection with the acquisition of the 4G license.

(2) Purchase commitments refer to orders placed and not rendered, primarily for the acquisition of materials of infrastructure, telecommunications equipment and mobile handsets in the normal course of operations.

- (3) Operating leases relate to the contractual rental agreements entered into by our businesses and include obligations related to leased lines and the rental of buildings. Rents are recognized on a straight-line basis during the period of the lease.

Off-Balance Sheet Arrangements

In connection with PTC and Meo, S.A.'s operations, they provide certain bank guarantees to third parties, including the Portuguese Ministry of Justice and ANACOM, and, in the case of PTC, highway construction entities. These guarantees are given to ensure the proper performance of contractual obligations by PTC or Meo, S.A., as applicable, in the normal course of their business. Bank guarantees presented to the tax authorities by PTC relate primarily to additional income tax assessments for which PTC submitted a claim or an appeal. As of September 30, 2014, PTC has granted €24.6 million of bank guarantees in favour of third parties and Meo, S.A. has granted €20.3 million of bank guarantees in favour of third parties, including bank guarantees of €18.0 million relating to the three €6.0 million instalments due to ANACOM for the acquisition of the 4G license. For further details regarding such bank guarantees and other financial commitments, see note 37 to the unaudited condensed financial statements of PTC and note 34 to the unaudited condensed financial statements of PTC and Meo, S.A.

Critical Accounting Policies, Judgments and Estimates

Our discussion and analysis of PTC's and Meo, S.A.'s financial condition and results of operations are based on the Audited Financial Statements and Interim Financial Information, which have been prepared in accordance with Portuguese GAAP. The significant accounting policies, judgments and estimates are summarized in Note 3 to the Audited Financial Statements of PTC and Meo, S.A. for the year ended December 31, 2013. PTC's and Meo, S.A.'s reported financial position and results of operations are sensitive to accounting methods, assumptions and estimates that underlie preparation of the consolidated financial statements. PTC and Meo, S.A. base their estimates on historical experience and on various other assumptions, the results of which form the basis for judgments about the carrying values of assets and liabilities that are not readily apparent from other sources.

We believe the following critical accounting policies involve the most significant judgments and estimates used in the preparation of PTC's and Meo, S.A.'s audited financial statements.

PTC

Post-employment benefits

The present value of liabilities for post-employment benefits is calculated based on actuarial methodologies, which use certain actuarial assumptions that are reviewed annually by PTC. Any change in these assumptions will impact the carrying value of liabilities. The main assumptions used are described in Note 11 to the Audited Financial Statements of PTC for the year ended December 31, 2013.

The fair value of certain investments made by our healthcare benefits funds is computed by third parties based on their judgments and information on the businesses and do not result from information verified in active markets.

Analysis of goodwill impairment

PTC tests annually whether goodwill has suffered any impairment. The recoverable amounts of cash-generating assets are determined based on value-in-use calculations. The use of this method requires the estimate of future cash flows expected to arise from the continuing operation of the cash generating asset, the choice of a growth rate to extrapolate cash flow projections and the estimate of a suitable discount rate for each cash generating asset. The main assumptions used in the goodwill analysis are disclosed in Note 8 to the Audited Financial Statements of PTC for the year ended December 31, 2013.

Useful life of tangible fixed assets

PTC uses estimates in order to determine to the useful life of tangible fixed assets.

Provisions recognition

PTC is party to several legal proceedings in progress for which, based on the opinion of its lawyers, judgments are made to determine the recognition of any necessary provisions to meet these contingencies.

Impairment recognition

Impairment on accounts receivable are calculated mainly based on receivables seniority, the client's risk profile and their financial situation.

Determining the fair value of assets measured by revaluation model

PTC uses the revaluation model to measure the book value of the asset classes "Land and natural resources", "Buildings and other constructions" and the "Telecommunication infrastructure" included under the caption "Basic equipment" under tangible fixed assets. In order to assess the fair value of real estate properties included under the assets classes "Land and natural resources" and "Buildings and other constructions", PTC uses external appraisers to determine their value based on certain specific indicators related to the real estate market. In order to assess the revalued amount of the asset class "Telecommunication infrastructure", PTC applied the cost replacement method based on current and observable prices of materials and construction work related to the installation underground of the telecommunication infrastructure.

Estimates used are based on the best information available during the preparation of financial statements, although future events, neither controlled nor foreseeable by PTC, could occur and have an impact on those estimates. In accordance with "NCRF 4 Accounting Policies, Changes in Estimates and Errors" ("NCRF 4"), changes to these estimates that occur after the date of the financial statements are recognized in net income, using a prospective methodology. For this reason and given the degree of uncertainty, real results of the transactions in question may differ from the corresponding estimates.

Meo, S.A.

Useful lives of tangible fixed assets and intangible assets

Meo, S.A. uses estimates to calculate the useful lives of tangible fixed assets and intangible assets.

Recognition of provisions and impairments

Meo, S.A. is party to a variety of ongoing judicial proceedings for which, based on the opinion of its lawyers, it used judgment to determine if it should recognize any provision in respect of these contingencies. Impairments for accounts receivable are calculated essentially based on the age of the accounts receivable, the risk profile of the clients and their financial situation.

The estimates were determined based on the best information available at the date the financial statements were prepared. As such, there may be events in subsequent periods that, not having been foreseeable at the time, were not considered in these estimates. In accordance with NCRF 4, changes to these estimates that occur after the date of the financial statements are corrected in the income statement prospectively. For this reason and given the associated degree of uncertainty, actual results for the transactions in question may differ from the corresponding estimates.

Summary of Significant Differences between Portuguese GAAP and IFRS

The primary difference between Portuguese GAAP and IFRS impacting total shareholders' equity relates to grants and subsidies for the acquisitions of assets, which under IFRS are deducted from the carrying amount of the related assets, while in accordance with Portuguese GAAP they are recorded as increases in shareholders' equity. In addition, there are also certain format differences between Portuguese GAAP and IFRS, the most important of which relates to equity in earnings and losses of affiliated companies, which is included within Income before depreciation and amortization, financing expense, and taxes under Portuguese GAAP and presented below EBITDA under IFRS.

The table below sets out the unaudited reconciliation between income before depreciation and amortization, financing expenses and taxes as reported by PTC and Meo, S.A. under Portuguese GAAP and EBITDA as prepared by PT Portugal SGPS, S.A. in the International Format:

	PTC					Meo, S.A.				
	Year ended December 31,			Nine months ended		Year ended December 31,			Nine months ended	
	2011	2012 ⁽³⁾	2013	2013	2014	2011	2012	2013	2013	2014
	€ in millions									
Income before depreciation and amortization, financing expenses and taxes under Portuguese GAAP	709.8	709.7	646.7	489.5	(597.6)	587.1	533.5	582.7	414.7	(739.9)
Minus ⁽¹⁾ :										

Equity in losses (earnings) of affiliated companies	(153.3)	(120.5)	(234.4)	(161.3)	1,021.3	(50.3)	(68.6)	(194.7)	(123.1)	1,034.7
Depreciation related mainly to investment subsidies.....	(3.5)	9.5	(3.2)	(2.7)	(1.5)	(0.0)	(0.0)	0.0	0.0	(0.0)
Post retirement benefits costs.....	53.9	57.3	40.3	31.7	31.2	—	—	0.0	0.0	0.1
Work force reduction program costs (gains).....	32.9	1.2	112.8	102.3	(21.9)	—	—	4.1	3.7	—
Losses (gains) on disposal of fixed assets	0.0	(1.3)	(3.4)	(2.9)	(23.5)	(0.1)	(2.2)	(0.1)	(0.1)	(3.5)
Non-recurring items	12.1	(42.0)	1.4	(1.3)	14.1	4.5	18.5	17.7	13.1	0.0
Provisions for income tax contingencies.....	8.0	7.2	(4.1)	(2.6)	0.4	0.5	1.0	0.2	(0.3)	0.2
Net financial results not directly related to net debt	(2.0)	(4.1)	(0.9)	(0.4)	(2.5)	(0.7)	(1.4)	(1.4)	(1.0)	(1.1)
EBITDA under the International Format ⁽²⁾	658.1	617.0	555.1	452.2	420.0	541.0	480.8	408.5	307.1	290.4

(1) Items included in income before depreciation and amortization, financing expenses and taxes under Portuguese GAAP but excluded under the International Format.

(2) EBITDA is defined as operating profit before depreciation and amortization, other expenses, net, management fees and restructuring and other non recurring costs.

(3) During the year ended December 31, 2013, PTC adopted the revised version of IAS 19 Employee Benefits as permitted by Portuguese GAAP. As a result of the adoption of the amendments to IAS 19, certain adjustments were made to the previously reported statements of financial position of PTC for the year ended December 31, 2012. The table above sets out PTC's restated results of operations for the year ended December 31, 2012 and may differ from that shown in the Audited Financial Statements of PTC for the year ended December 31, 2012. See Note 5 to the Audited Financial Statements of PTC for the year ended December 31, 2013.

Recent Portuguese GAAP Accounting Pronouncements

Portuguese GAAP was approved by the Decree Law No. 158/2009, dated 13 July, and in accordance with the Conceptual Structure, Accounting and Financial Reporting Standards (“NCRF”) and Interpretative Standards, as approved by Notices n° 15652/2009, 15653/2009 and 15655/2009 of the General- Secretary of the Ministry of Finance, dated 27 August, which make up the New Portuguese accounting system, named “*Sistema de Normalização Contabilística*” (“SNC”). SNC came into force in 2010, with the transition date being January 1, 2009 for the purposes of presentation of the financial statements of PTC and Meo. NCRFs were formulated based on IFRS that prevailed in June 2007 and no modifications have been introduced in Portuguese GAAP since. In order to fill gaps or omissions in the SNC regarding specific transactions, PTC and Meo, S.A. apply IAS/IFRS and related interpretations issued by IASB.

Seasonality

Although our revenues and costs fluctuate from quarter to quarter, we do not experience large fluctuations due to seasonality. We tend to have higher revenues (but lower EBITDA) in the fourth quarter due to promotional campaigns centered on the Christmas holiday. To a lesser degree, promotional campaigns at the time of the Easter and Mother’s Day holidays also tend to increase our revenues in the second quarter. In addition, our revenues from our operations tend to be lower during the Portuguese summer holidays during the third quarter.

Qualitative and Quantitative Analysis of Market Risk

Our most significant market risk exposures are interest rate risk and exchange rate risk and, to a lesser extent, commodity risk. Once the PT Portugal Group forms a part of the Altice International Group following the PT Portugal Acquisition, our market risk profile will change and we will manage such risks through the Altice International Group. For further details, see “*Management’s Discussion and Analysis of Financial Condition and Results of Operations of the Group— Quantitative and Qualitative Disclosures about Market Risk*”.

MANAGEMENT'S DISCUSSION AND ANALYSIS OF FINANCIAL CONDITION AND RESULTS OF OPERATIONS OF ODO

The following discussion and analysis of the results of operations and financial condition of Altice Hispaniola S.A. ("ODO") is based on its audited standalone financial statements as of and for the twelve months ended December 31, 2012 and 2013, in each case, prepared in accordance with IFRS as issued by the IASB. For a discussion and analysis of the results of operations and financial condition of ODO as of and for the nine months ended September 30, 2013 and 2014, see "Management's Discussion and Analysis of Financial Condition and Results of Operations of the Group".

Except as the context otherwise indicates, when discussing historical results of operations in this section, "Company," "we," "our" and other similar terms are generally used to refer to the business of ODO.

You should read the discussion below in conjunction with the standalone financial statements of the Company and the accompanying notes in these Listing Particulars. A summary of the critical accounting estimates that have been applied to the Company's financial statements is set forth below in "—Critical Accounting Estimates." You should also review the information in the section "—Presentation of Financial Information". This discussion also includes forward-looking statements which, although based on assumptions that we consider reasonable, are subject to risks and uncertainties which could cause actual events or conditions to differ materially from those expressed or implied by the forward-looking statements. For a discussion of risks and uncertainties facing us as a result of various factors, see "Risk Factors".

Presentation of Financial Information

The standalone financial statements of the Company for the twelve months ended December 31, 2012 and 2013 have been prepared in accordance with IFRS as issued by the IASB. The preparation of the financial statements did not, therefore, require any material allocation of assets and liabilities and income and expense items between Orange S.A., as indirect owner of the Company prior to the ODO Acquisition, and the Company.

Key Factors Affecting Results of Operations

Our performance and results of operations have been and will continue to be affected by a number of factors, including external factors. Certain of these key factors that have had, or may have, an effect on our results are set forth below. For further discussion of the factors affecting our results of operations, see "Risk Factors".

One of the key constituents of our revenue is network revenue, which contributed 87.7% and 86.7% of our total revenue for the twelve months ended December 31, 2012 and 2013, respectively. A major contributor to our network revenue is mobile subscriber revenue, which is principally driven by the number of mobile subscribers on our network (our mobile subscriber base), and the ARPU, or average revenue per user (see "—Mobile ARPU"), that they generate. Our subscriber base evolution is driven by market dynamics (including demographics, penetration rate, technical innovation and changing customer behavior), gross connections market share (our ability to capture new subscribers). A key recent factor that has impacted our mobile subscriber revenue is the increasing use of data services linked to the popularity of smartphones and mobile computing devices, and our ability to successfully address this increasing demand. Furthermore, our mobile revenues are affected by macroeconomic trends, such as competition-driven price evolution and general macro-economic conditions. Network revenue also includes revenues from incoming voice traffic of other domestic and international operators, as well as roaming charges, and non-voice.

Our mobile costs of sale include (i) mobile termination rates payable to other operators for calls made by our subscribers that are terminated on networks belonging to other operators, (ii) subscriber acquisition and retention costs, which are costs associated with acquiring a new mobile subscriber and retaining existing subscribers (prolonging the contract of an existing mobile subscriber, mobile "renewal" for pre-paid residential subscribers, (iii) network and IT expenses and (iv) other commercial expenses relating to advertising, promotion and other selling fees.

Our primary subscriber acquisition and retention costs include agent commissions related to sales generated by dealers including franchises and wholesalers (together forming our indirect distribution channel) and the cost of handsets sold to our post-paid residential subscribers. Handsets are typically sold to our post-paid subscribers at a discount reflecting the incentive that we provide subscribers to subscribe or renew their subscription. The level of distributor commission paid varies depending on distribution channels (direct or indirect). Our distributor commissions are generally lower for pre-paid residential customers, due to lower ARPU and lower loyalty of pre-paid subscribers, compared to the distributors' commissions for post-paid business customers reflecting the higher lifetime value of these subscribers. Commissions, which are an operating expense, are paid for both, new and retained post-paid subscribers solicited through indirect distribution channels. In the direct distribution channel, incentives and bonuses are paid out to the sales force in relation to their subscriber acquisition and retention performance and such costs are expensed in labor costs. Our direct channels focus on high value customers and providing them with a high quality customer experience and services.

Mobile Subscriber Base

The table below sets forth selected mobile subscriber data for the periods indicated, including an analysis by subscriber segment. Mobile subscribers consist of subscribers for voice services (including incoming and outgoing calls) and non-voice services (including SMS, MMS and data services for handsets).

	Mobile subscriber base	
	For the twelve months ended December 31,	
	2012	2013
Post-paid subscribers ⁽¹⁾⁽²⁾⁽⁴⁾⁽⁵⁾	589	624
Pre-paid residential subscribers ⁽¹⁾⁽³⁾⁽⁴⁾	2,504	2,647
Subscribers at end of period⁽¹⁾	3,093	3,271

- (1) Includes subscribers through reseller (dealers and franchises) as we enter into direct contractual arrangements with customers of resellers
- (2) All post-paid subscribers are considered as active
- (3) Active pre-paid subscribers exclusively. Pre-paid subscribers are considered as inactive when connected on the home network more than three months without any outgoing traffic events or with fewer than four incoming traffic events
- (4) Includes exclusively mobile subscribers. Mobile broadband internet subscribers excluded and analyzed separately in this section
- (5) Includes both post-paid residential subscribers and post-paid business subscribers

We provide mobile services to pre-paid residential customers, post-paid residential customers and post-paid business customers, constituting 80.9%, 13.2% and 5.9%, respectively, as of December 31, 2013, of our mobile subscriber base. For the twelve months ended December 31, 2013, pre-paid residential subscribers formed the largest segment of our customer base, contributing 53.1%, as compared to 28.1% for post-paid residential subscribers and 9.1%, for post-paid business subscribers. Since contributions to revenue of subscribers in different segments are disproportionate (due to their different level of ARPU, see “—Mobile ARPU”), changes in the composition of our subscriber base in any financial period may have an impact on our revenue for such period.

Our mobile subscriber base increased by 5.8% for the twelve months ended December 31, 2013, as compared to the twelve months ended December 31, 2012. The key drivers of this sustained growth are: (i) favorable market dynamics; (ii) increased market share, due to the positive perception of the “Orange” brand and the quality of our service; (iii) on-going network improvements, with the continuous roll-out of 2G, 3G and 4G sites; (iv) competitive pre-paid and post-paid offers with the continuous expansion of our enterprise line; (v) anti-churn incentives geared at our pre-paid residential subscribers to reduce the number of inactive customers, including automated reminders prompting the subscriber to top-up, simplified SIM swaps for customers who have lost their SIM cards and an automated credit top-up by us where a “zero balance” has been reached; and (vi) the strategic plan by our management to develop the business lines for our post-paid business subscribers with a sales team dedicated to this customer base as well as targeted offers.

As a result of the aforementioned factors, for the twelve months ended December 31, 2013, our post-paid business subscribers increased by 4.1% and our pre-paid residential subscribers 5.7%. We estimate that our total mobile market share in the Dominican Republic by number of subscribers was 40% as of December 31, 2013.

Due in part to the improvement of our post-paid residential offer, our post-residential subscribers increased by 6.9% for the twelve months ended on December 31, 2013 compared to the same period last year. The revamped offer, which began in September 2013, introduced a more varied portfolio of price plans, allowing customers to add on additional services at their option while giving them the freedom of paying a low monthly fee on a post-paid basis. Because the difference between the monthly top-up and post-paid subscription fee is very small, we believe that users of pre-paid mobile phones will continue to migrate to a post-paid subscription. Furthermore, we offer substantial handset subsidies to our post-paid subscribers, which enable us to promote the usage of smartphones and with that voice and data usage. We aim to increase our market share in the post-paid residential segment in the future, especially in light of the increase in smartphone and data usage, and higher returns and retention rates in the long term.

Mobile ARPU

ARPU (average revenue per user), represents the overall revenue for a specific segment divided by the number of subscribers for a given period. Since there may be disconnections and connections over a defined period, the overall revenue is divided by the average subscriber base for that particular period.

ARPU is primarily driven by prices of our services, traffic volume, data services utilization and revenue from interconnection rates for incoming calls. Our monthly ARPU for the twelve months ended December 31, 2013 increased slightly to DOP 533.1, from ARPU of DOP 532.9 for the twelve months ended December 31, 2012 despite termination rates decreasing by 2% semi-annually. The table below sets out our ARPU for our pre-paid and post-paid mobile subscribers:

	Mobile ARPU	
	For the twelve months ended December 31	
	2012	2013
	in DOP per month/percentages	
Post-paid ARPU	1,126	1,146
Increase/(decrease) from prior equivalent period	(-7.6)%	1.7%
Pre-paid residential ARPU	393	394
Increase/(decrease) from prior equivalent period	0.5%	0.2%
Total ARPU⁽¹⁾	533	533
Increase/(decrease) from prior equivalent period	(-0.4)%	0.1%

(1) We define total ARPU as the measure of the sum of our mobile revenues in the relevant period divided by the average number of mobile subscribers in the period (the average of each month's average number of mobile subscribers (calculated as the average of the total number of mobile subscribers at the beginning of the month and the total number of mobile subscribers at the end of the month)) divided by the number of months in that period.

For the twelve months ended December 31, 2013, our post-paid ARPU increased by 1.7% to DOP 1,146 from DOP 1,126 for the twelve months ended December 31, 2012. This increase was predominantly driven by an increase of our post-paid residential subscriber ARPU by 5.0% (or DOP 62 per month) to DOP 1,312 for the twelve months ended December 31, 2013. This increase can be attributed to an increase in higher value plans.

As of December 31, 2013, we have been able to maintain our pre-paid residential subscriber ARPU at DOP 394, as compared to DOP 393 as of December 31, 2012.

Termination Rates

Mobile termination rates (MTR) contribute to our mobile revenues and costs. Fixed termination rates (FTR) contribute to our revenue and costs for our fixed line services. We receive revenues from other operators for calls terminated on our network and we are required to pay fees to other operators for calls terminated on their networks for both domestic and international calls.

Domestic MTR, local FTR and SMS termination rates result from negotiations between us and the three other main Dominican mobile operators. Indotel has the authority to challenge and/or validate these bilateral agreements. Domestic operators agreed to decrease national MTR and local FTR by 2% semiannually (in dollars), between 2010 to 2013. SMS termination rates remained unchanged between 2010 to 2013 at \$0.018 per SMS.

	Year ended December 31,			
	2010	2011	2012	2013
	USD \$			
MTR.....	0.069	0.066	0.064	0.062
FTR local	0.018	0.018	0.017	0.016
SMS	0.018	0.018	0.018	0.018

Internet

For the twelve months ended December 31, 2013, internet revenues increased by 27% to DOP 644 million compared to DOP 507 million for the twelve months ended December 31, 2012. We consider internet services used by our post-paid business subscribers as a commercial lever to cross-sell post-paid business mobile subscription.

Our total number of internet subscribers increased by 16% from 121,000 for the twelve months ended December 31, 2012, to 140,000 for the twelve months ended December 31, 2013. This was mainly driven by an increase in the number of our post-paid residential subscribers by 51% in 2013 due to (i) higher laptop penetration, and (ii) the expansion of internet services into new geographic regions. Although we had an increase in our total subscriber number, we saw a decrease in our post-paid business subscribers due to an internal adjustment made to the computation of this subscriber base in 2013.

The table below shows our internet subscriber base for the twelve months ended December 31, 2012 and 2013, respectively:

	Internet subscriber base	
	For the twelve months ended December 31,	
	2012	2013
	in thousands subscribers	
Post-paid residential subscribers ⁽¹⁾	62	86
Post-paid business subscribers ⁽¹⁾	59	54
Subscribers at end of period⁽¹⁾	121	140

(1) All post-paid subscribers are considered as active

Mobile Network Upgrade

With the growing penetration of smartphones and the increasing demand in data services, upgrading and maintaining our network is key to the improvement of the services we offer to our customers. The perception of the network quality is an important factor in retaining our subscribers and is therefore a key element in preventing and reducing churn and attracting new customers.

The upgrade and maintenance of our network has a direct impact on the level of our expenses and the capital expenditures we incur each year. The 4G-LTE roll-out which began in the first quarter of 2012 has been focused on certain regions with higher number of medium and large businesses. We believe that our infrastructure will be able to cope with the expected increased data-led capacity requirements and that architecture is scalable to support future traffic growth.

Effects of Change of Control Transaction and Separation

On November 26, 2013, Altice Bahamas S.à r.l. (a wholly owned subsidiary of Altice International S.à r.l.) entered into agreements to acquire ODO in the Dominican Republic. The transaction has been completed on April 9, 2014. See “*Description of Our Business—History*”.

The impact of the ODO Acquisition on our income statement and capital expenditures will depend on the synergies and measures undertaken. We may not realize any or all of the anticipated synergies of the ODO Acquisition that we currently anticipate. For a discussion of the risks relating to the integration of ODO into the Altice International Group, see “*Risk Factors—Risks Relating to the Integration of Tricom and ODO into Our Business*”.

Key Income Statement Line Items

Revenue

Revenue from our activities includes:

- Mobile revenue, which consists of revenue from voice (including ingoing and outgoing calls) and non-voice (including SMS, MMS and data services for handsets);
- Internet revenue, which consists of mobile broadband internet facilities delivered to post-paid residential subscribers or business post-paid subscribers;
- Wholesale revenue, which consists of: (i) transit revenue consisting of fees charged to foreign competitors connecting to and using our telecommunication path and network to transit voice or data to another operators, and (ii) visitor roaming revenue representing revenue received from our roaming partners for their customers’ use of

services on our network. Roaming rates charged by various operators are determined according to the inter-operator tariffs (IOT) agreements between operators;

- Other revenue primarily includes (i) the sale of non-subsidized handsets (ii) fixed-data revenue corresponding to calls realized through IPVPN technology, which are primarily fixed calls for business subscribers, and to a lesser extent, (iii) global services revenue (mainly machine-to- machine (M2M) solutions e.g. industrialized private access point names (APN)) as well as other minor components;
- Equipment revenue consists of the sale of subsidized handsets and, to a lesser extent, mobile accessories.

Operating costs

Our operating costs include:

- Cost of equipment sold primarily consists of the costs arising from equipment sold to terminals, the sale of SIM cards and accessories, and import duties and freight costs;
- Selling, distribution and traffic costs mainly consist of access backbone and termination fees corresponding to costs incurred for terminating a call on another operator’s network. Cost is calculated based on the MTR or FTR tariffs which are agreed between operators;
- Advertising and sponsoring costs;
- Offices and technical sites costs;
- Labor expenses, which include salaries and wages, social contributions, individual incentive/bonus plans and the cost of post-employment benefits;
- Corporate fees consist of (i) management fees, and (ii) brand fees based on the terms of the agreement with Orange S.A. regarding the rights to use the “Orange” brand;
- Maintenance costs;
- Other costs and income which include (i) purchase of services (ii) consulting fees (iii) network energy costs and (iv) bad debt expenses;
- Depreciation and amortization of fixed assets.

Non-operating income/expense

Non-operating income/expense mainly include financial items such as (i) foreign exchange gains and losses (mainly corresponding to unrealized translation gains on cash and cash equivalents) (ii) interest on net cash, and on the Orange group current account (decreasing in line with cash and cash equivalents) and (iii) other financial charges concerning the discounting effect of the Asset Retirement Obligation (“ARO”) provision, whereby a discount is applied to the costs incurred in relation to the future dismantling of technical sites (the rate is calculated through applying intra-group measures and a discount set by the Dominican Central Bank).

The table below shows our results of operations for the twelve months ended December 31, 2012 and 2013, respectively:

	For the twelve months ended December 31,	
	2012	2013
	in DOP million	
Revenues	22,754	24,405
Cost of equipment sold.....	(3,000)	(3,259)
Selling, distribution and traffic costs	(5,861)	(6,263)
Advertising and sponsoring costs	(937)	(875)
Offices and technical sites costs.....	(564)	(623)
Labor expenses	(1,175)	(1,234)
Corporate fees.....	(583)	(628)
Maintenance costs	(332)	(329)
Other costs and income	(2,573)	(2,344)
Depreciation and amortization	(3,509)	(3,518)

Total costs and operating expenses.....	(18,533)	(19,073)
Operating income	4,221	5,332
Bank commissions.....	(71)	(76)
Interest income	37	18
Foreign currency exchange gains (losses)	70	26
Other	(20)	(13)
Non-operating income (expenses)	15	(45)
Profit before income tax	4,236	5,287
Income tax	(790)	(1,390)
Net income	3,446	3,897
Other comprehensive income.....	—	—
Total comprehensive income for the year	3,446	3,897

Twelve Months Ended December 31, 2013 as compared to Twelve Months Ended December 31, 2012

Our total revenue increased by DOP 1,651 million (+ 7.3%) from DOP 22,754 million for the twelve months ended December 31, 2012 to DOP 24,405 million for the twelve months ended December 31, 2013, driven by an increase in our pre-paid subscriber base together with the favorable effect of increased data usage.

	For the twelve months ended December 31,				Variation	
	2012	% of total revenue	2013	% of total revenue	Amount	%
			in DOP million			
Mobile.....	19,436	85.4%	20,503	84.0%	1,067	5.5%
Wholesale	1,662	7.3%	1,816	7.4%	154	9.3%
Internet.....	507	2.2%	644	2.6%	137	27.0%
Equipment.....	866	3.8%	1,151	4.7%	285	32.9%
Other	283	1.2%	291	1.2%	8	2.8%
Total revenue	22,754	100%	24,405	100.0%	1,651	7.3%

	For the twelve months ended December 31,				Variation	
	2012	% of total revenue	2013	% of total revenue	Amount	%
			in DOP million			
Post-paid residential subscribers .	6,084	31.3%	6,372	31.1%	288	4.7%
Pre-paid residential subscribers...	11,580	59.6%	12,350	60.2%	770	6.6%
Post-paid business subscribers	1,772	9.1%	1,781	8.7%	9	0.5%
Mobile revenue	19,436	100.0%	20,503	100.0%	1,067	5.5%

Mobile revenue

Mobile revenue was DOP 20,503 million for the twelve months ended December 31, 2013, an increase of DOP 1,067 million, or 5.5%, from DOP 19,436 million for the twelve months ended December 31, 2012.

Post-paid residential subscribers revenue increased by 4.7% in the twelve months ended December 31, 2013 to DOP 6,372 million primarily driven by flexible monthly plans, including low monthly rate subscriptions with the ability to add-on additional services such as data through promotional offers.

Pre-paid residential subscribers revenue increased by 6.6% in the twelve months ended December 31, 2013 to DOP 12,350 million primarily driven the “anti-churn” incentives.

Post-paid business subscribers revenue increased by 0.5% in the twelve months ended December 31, 2013 to DOP 1,781 million primarily driven by a stronger penetration strategy and sales staff dedicated to soliciting more subscribers. We also benefited from an overhaul in and an increase of the portfolio of services and integrated solutions we were able to offer to a broad variety of businesses (SMEs as well as larger business).

Wholesale revenue

Wholesale revenue was DOP 1,816 million for in the twelve months ended December 31, 2013, an increase of DOP 154 million, or 9.3%, from DOP 1,662 million for the twelve months ended December 31 2012. This increase can be attributed to an increase in transit revenues by 37.1% to DOP 1,192 million for the twelve months ended December 31, 2013, as a result of increased traffic of international telephone calls on our network, resulting in higher terminations. This trend was offset by a decrease in visitor roaming revenue—of 21.4% to DOP 623 million for the

twelve months ended December 31, 2013, as result of the increase in tariff competition thereby pushing down global inter-operator roaming rates, as well as international macro-economic conditions.

Internet revenue

Internet revenue increased by 27.0% to DOP 644 million in the twelve months ended December 31, 2013 mainly due to the increase in the average subscriber base driven by the expansion of internet services into new geographic regions, our 3G roll-out and the resulting increase in the higher quality offering over a larger service area, resulting from the speed of our network.

Equipment revenue

Equipment revenue was DOP 1,151 million for the twelve months ended December 31, 2013, an increase of DOP 285 million, or 32.9%, from DOP 866 million for the twelve months ended December 31, 2012, due to an increase in our post-paid subscribers retention rate, which resulted in higher amounts of handset subsidies .

Other revenue

Other revenue was DOP 291 million for the twelve months ended December 31, 2013, an increase of DOP 8 million, or 2.8%, from DOP 283 million for the twelve months ended December 31, 2012 as a result of an increase in our post-paid business segment, leading to an increase in M2M revenue of 123% and other operating revenue of 62%.

Operating costs

Cost of equipment sold

Cost of equipment sold were DOP 3,259 million for the twelve months ended December 31, 2013, an increase of DOP 259 million, or 8.6% from DOP 3,000 million for the twelve months ended December 31, 2012. The increase in cost of equipment sold was mainly due to an increase in smartphone penetration as part of our retention strategy relating to our post-paid residential subscribers.

Selling, distribution and traffic costs

Selling, distribution and traffic costs were DOP 6,263 million for the twelve months ended December 31, 2013, an increase of DOP 402 million, or 6.9%, from DOP 5,861 million for the twelve months ended December 31, 2012. The increase was mainly due to an increase in commissions paid to indirect distributors for high retention rates of post-paid subscribers.

Advertising and sponsoring costs

Advertising and sponsoring costs decreased DOP 62 million, or 6.6%, from DOP 937 million for the year ended December 31, 2012 to DOP 875 million for the year ended December 31, 2013 primarily due to measures implemented by management to optimize advertising costs and communication methods.

Offices and technical sites costs

Offices and technical sites costs were DOP 623 million for the twelve months ended December 31, 2013, an increase of DOP 59 million, or 10.45%, from DOP 564 million for the twelve months ended December 31, 2012. The increase in technical expenses was primarily driven by network extension (site roll-out), partially offset by some savings initiatives (notably regarding base station/antenna power savings through investment in solar panels).

Labor expenses

Labor expenses were DOP 1,234 million for the twelve months ended December 31, 2013, an increase of DOP 59 million, or 5.0%, from DOP 1,175 million for the twelve months ended December 31, 2012. The increase in labor expenses was primarily attributable to an increase in average total labor cost per employee driven annual salary increases and impacted by the recruitment of more experienced employees.

Corporate fees

Corporate fees were DOP 628 million for the twelve months ended December 31, 2013 increasing from DOP 583 million, or 7.7% for the twelve months ended December 30, 2012 due to revenue growth.

Maintenance costs

Maintenance costs were DOP 329 million for the twelve months ended December 31, 2013 a decrease of DOP 3.0 million, or 0.9%, from DOP 332 million for the twelve months ended December 31, 2012. The decrease is mainly attributable to volume discounts relating to network extension.

Other costs and income

Other costs and income decreased to DOP 2,344 million for the twelve months ended December 31, 2013, a decrease of DOP 229 million, or 8.9%, from DOP 2,573 million for the twelve months ended December 31, 2012. This decrease was mainly due to (i) a reduction in the provision for legal claims from DOP 165 million in the twelve months ended December 31, 2012 to DOP 115 million for the twelve months ended December 31, 2013, due to a judgment dismissing the payment of certain costs and (ii) a decrease in withholding taxes of DOP 51 million as a result of improved negotiations with our suppliers and the Group.

Depreciation and amortization

Depreciation and amortization were DOP 3,518 million for the twelve months ended December 31, 2013, a slight increase of DOP 9 million, or 0.3%, from DOP 3,509 million for the twelve months ended December 31, 2012. The increase in depreciation and amortization was primarily attributable to the increase of network assets with improvements in network coverage, as well as the roll-out of additional 2G/3G/4G-LTE sites. Furthermore, ODO performed an inventory of its fixed assets relating to its technical sites (which account for 83% of total fixed assets) between April 2013 and December 2013 which lead to an increase of DOP 23 million in depreciation.

Operating income

As a result of the foregoing factors, our operating income was DOP 5,332 million for the twelve months ended December 31, 2013 compared to DOP 4,221 million for the twelve months ended December 31, 2012, representing an increase in operating margins by 26.3% for the twelve months ended December 31, 2013 as compared to 2.5% for the twelve months ended December 31, 2012.

Non-operating income/expense

Non-operating expenses increased to DOP 45 million for the twelve months ended December 2013, compared to non-operating income of DOP 15 million for the twelve months ended December 31, 2012. The decrease in non-operating income/expense for the twelve months ended December 31, 2013 was due to (i) DOP 76 million of bank commissions as a result of a higher volume in connections for our post paid segment (compared to DOP 71 million for the twelve months ended December 31, 2012), (ii) DOP 18 million from the twelve months ended December 31, 2013 of interest income compared to DOP 37 million for the year ended December 31, 2012 as a result of the reduction of interest rates by the Dominican Central Bank in 2013 and (iii) an increase in foreign currency exchanges which led to a decrease in gains to DOP 26 million for the twelve months ended December 31, 2013, compared to DOP 70 million for the twelve months ended December 31, 2012.

Income Tax

The following table sets forth our income tax expense for the twelve months ended December 31, 2013 as compared to the twelve months ended December 31, 2012:

	<u>For the twelve months ended December 31,</u>		<u>Variation</u>	
	<u>2012</u>	<u>2013</u>	<u>Amount</u>	<u>%</u>
	<i>in DOP million/percentages</i>			
Current tax expense in respect of the current year	(1,123)	(1,574)	(451)	40.2%
Deferred tax income/(expense)	333	184	(149)	(44.7)%
Total income tax	(790)	(1,390)	(600)	75.9%

Income tax increased by DOP 600 million from DOP 790 million for the twelve months ended December 31, 2012 to DOP 1,390 million for the twelve months ended December 31, 2013 primarily driven by a change in dividend credits. Dividend credits decreased from DOP 330 million for the twelve months ended December 31, 2012 to nil in the twelve months ended December 31, 2013. Such dividend credits relate mainly to the refund of dividend withholding tax which terminated with the change in certain tax regulations in the Dominican Republic in November 2012. Furthermore, the increase can be attributed to an increase in profit before tax for the twelve months ended December 31, 2013.

Liquidity and Capital Resources

Capital Resources

Our principal source of liquidity is cash flow generated from our operations and other resources within the Altice International Group. For the liquidity and capital resources of the Altice International Group, see “*Management’s Discussion and Analysis of Financial Condition and Results of Operations of the Group—Liquidity and Capital Resources*”.

Cash Flows

The table below sets out information related to our cash flows:

	For the twelve months ended December 31,	
	2012 ⁽¹⁾	2013
	in DOP million	
Operating activities		
Net income.....	3,446	3,897
<i>Adjustments to reconcile net profit to cash provided by operating activities</i>		
Depreciation and amortization	3,509	3,518
Gains (losses) on disposal	1	14
Change in provisions (Litigations).....	68	(87)
<i>Change in working capital</i>		
Income tax	(333)	(184)
Decrease (increase) in inventories, net	105	(151)
Decrease (increase) in trade receivables,	(59)	105
Decrease (increase) in other receivables,	(3)	(2,343)
Decrease (increase) in trade payables	(483)	(239)
<i>Other changes in working capital</i>		
Decrease (increase) in pre-paid expenses	25	(58)
Decrease (increase) in other non-current assets.....	(2)	0
Decrease (increase) in other non-current liabilities.....	8	23
Decrease (increase) in other current.....	47	23
Deferred income	42	(118)
Income tax paid	625	533
Net cash provided by operating activities.....	6,997	4,933
Investing activities		
Purchase of PPE and intangible assets.....	(3,637)	(3,199)
Net cash used in investing activities	(3,637)	(3,199)
Financing activities		
Dividends paid.....	(3,345)	(1,855)
Net cash used in financing activities.....	(3,345)	(1,855)
Net increase (decrease) in cash and cash	15	(121)
Cash and cash equivalents—opening.....	1,145	1,160
Cash and cash equivalents—closing.....	1,160	1,039

(1) ODO 2012 figures have been adjusted and restated to show a like for like comparison between the cash flow statements for the twelve months ended December 31, 2013 and 2012. The restatement consisted of netting between trade receivables and trade payables for an amount of DOP 633 million.

Twelve Months ended December 31, 2013 as compared to twelve months ended December 31, 2012

Net cash provided by operating activities

Net cash provided by operating activities for the twelve months ended December 31, 2013 was DOP 4,933 million. Our net cash provided by operating activities for the twelve months ended December 31, 2012 included net income of DOP 3,897 million and depreciation and amortization of DOP 3,518 million. Change in net working capital was negative DOP 2,628 million for this period, principally reflecting an increase in other accounts receivables of DOP 2,343 million. The account receivables significant increase is predominantly due to the cash pooling at the Orange Group’s level (DOP 2,567 million in December, 2013 compared to DOP 136 million in December 2012). As per the internal accounting rules of the Orange Group, cash pooling is registered at ODO’s account receivables with the group, subsequently impacting the total account receivables balance. ODO made dividend payments of USD 45 million (DOP 1,855 million

with an exchange rate of DOP 41.23 = US\$1.00 (as of May 24, 2013) during 2013, compared to USD 84 million (DOP 3,345 million with an exchange rate of DOP 39.82 = US\$ 1.00 (at an average rate at the relevant payment dates (April, September, November 2012)). We define net working capital as the sum of inventories, trade receivables, trade payables and other receivables.

Net cash used in investing activities

Net cash used in investing activities for the twelve months ended December 31, 2013 and 2012 was DOP 3,199 million and DOP 3,637 million, respectively. Net cash used in investing activities during this period principally related to our network and IT capital expenditure plans.

Net cash used in financing activities

Net cash used in financing activities for the twelve months ended December 31, 2013 and 2012 was DOP 1,855 million and DOP 3,345 million, respectively. This decrease was due to a decision by the Board of ODO to limit the dividends payment at USD 45 million (DOP 1,855 million with an exchange rate of DOP 41.23 = US\$1.00 (at May, 2013) (reflecting the date of ODO's board meeting) in the second half of 2013).

Off balance sheet commitments

The following table summarizes our contractual commitments that we believe are likely to have a material effect on our current or future financial position as of December 31, 2013. The information presented in this table reflects, in part, management's estimates of the contractual maturities of our obligations, which may differ significantly from the actual maturities of these obligations:

	As of December 31, 2012		As of December 31, 2013	
	in DOP million/percentages			
Rental commitments ⁽¹⁾ ..	1,975	49%	2,374	55%
Orders related to handset purchase	632	16%	405	9%
Other Open commitments	459	11%	430	10%
Open commitments	3,065	76%	3,209	74%
Capex commitments	966	24%	1,127	26%
Total off-balance sheet commitments	4,031	100.0%	4,336	100.0%

(1) Rental commitments primarily relate to rental commitments in respect of sites, premises (headquarters), shops, franchises, parking spaces and houses

Capital Expenditures and Investments

The table below shows our capital expenditures defined as additions of network, customers, IT, shops and other items for the twelve months ended December 31, 2012 and 2013:

	For the twelve months ended December 31,			
	2012		2013	
	in DOP million/% of weight			
Network	2,521	69.3%	2,183	68.2%
Customers	404	11.1%	229	7.2%
IT	443	12.2%	586	18.3%
Shops	98	2.7%	61	1.9%
Other (incl. GSM licenses)	171	4.7%	140	4.4%
Total capital expenditure	3,637	100.0%	3,199	100.0%
CAPEX as % of Revenue	16.0%		13.1%	

For the twelve months ended December 31, 2013, our total capital expenditure amounted to DOP 3,199 million, of which DOP 2,183 million related to our network. Most 2G capital expenditure was related to the construction of new sites (civil

works, towers, antennas and base transceiver stations) to complete 2G coverage and improve network quality, while 3G and 4G capital expenditure were done to increase transmission capacity, network coverage, support data traffic growth and create competitive advantage through innovation and 4G services (notably following the rise of the data revenue stream resulting from increasing penetration of smartphones). We have also invested in new platforms, international capacity, core upgrades, and generators.

Quantitative and Qualitative Disclosures about Market Risk

We are exposed to various market risks, including foreign currency exchange rate, credit and liquidity risks associated with our underlying assets, liabilities, forecast transactions and firm commitments. Our treasury department is responsible for managing exposure to market risk that arises in connection with operations and financial activities, including interest rate, foreign currency exchange rate, credit and liquidity and credit risk management.

The following sections discuss our significant exposures to market risk. The following discussions do not address other risks that we face in the normal course of business, including country risk and legal risk.

Foreign Exchange Rate Risk Management

As much as possible, we use foreign currency inflows for our foreign currency outflows. If necessary, we buy foreign currency shortly before the transaction. If any material exposure arises, we may enter into foreign exchange rate hedging instruments.

We are a net buyer of foreign currencies (in particular USD and euro via brand fees paid to the Orange Group). Our local interconnection costs are considered in both revenue and operating expenses in USD which typically limits our exposure due to a netting effect. A significant proportion of capital expenditure is denominated in foreign currency, mainly euro.

Credit Risk Management

Financial instruments that could potentially subject us to concentrations of credit risk consist primarily of cash, trade receivables and securities, investments and deposits.

We believe that we have a limited exposure to concentrations of credit risk with respect to trade accounts receivable due to our large and diverse customer base (residential, and a broad range of business customers). In addition, the maximum value of the credit risk on these financial assets is equal to their recognized net book value. Our gross trade receivables amounted to DOP 2,294 million as of December 31, 2013 and DOP 2,425 million as of December 31, 2012. We have certain provisions in place relating to bad debt, which are split between a provision for dealers and others amounting to DOP 461 million as of December 31, 2013 and DOP 488 million as of December 31, 2012. We also have provisions for our post-paid subscribers, whereby we use certain statistics relating to the outstanding amount due and ageing analysis to establish the risk, with 210 days being the threshold for categorizing outstanding trade receivables as bad debt.

Prior to the ODO Acquisition, cash was historically centralized at the Orange Group level through cash pooling.

We seek to minimize credit risk through a preventative credit check process that aims to ensure that all subscribers requesting new products and services or changes to existing services are reliable and solvent. We also seek to minimize credit risk by preferring contracts that provide for the use of automatic payment methods with the aim of reducing the underlying credit risk, however, the use of direct debit is generally unpopular in the Dominican Republic market.

We additionally exercise timely pre- and post-subscriber acquisition measures for the purpose of credit collection such as the following:

- attribution of a rating to new customers at subscription through the credit check (to anticipate default payment, different measures may be implemented such as requiring deposits or advance payments of or limiting to prepaid offers;
- sending payment reminders to subscribers;
- employing measures for the collection of overdue receivables, separated by strategy, portfolio and subscriber profiles (such as penalties, or reconnection letters with an option for a new contract); and
- measuring and monitoring debt collection status through our internal reporting tools.

The following table provides the ageing analysis of billed trade receivables as of December 31, 2013 and December 31, 2012, for both dealers and post-paid residential subscribers:

	Dealers and others			
	As of December 31, 2012⁽¹⁾		As of December 31, 2013	
	in DOP million/percentages			
Not due or less than 30 days	779	54%	614	50%
Between 31 and 60 days	533	37%	198	16%
Between 61 and 90 days	49	3%	80	7%
More than 91 days	87	6%	325	27%
Total gross trade receivables past due	1,448	100%	1,216	100
Provisions for bad debt	(299)	—	(284)	—
Net receivables	1,149	—	932	—

(1) ODO 2012 figures have been adjusted and restated to show a like for like comparison between the cash flow statements for the twelve months ended December 31, 2013 and 2012. The restatement consisted of a netting between trade receivables and trade payables for an amount of DOP 633 million.

	Post-paid residential subscribers			
	As of December 31, 2012		As of December 31, 2013	
	in DOP million/percentages			
Not due or less than 30 days	605	62%	825	77%
Between 31 and 60 days	116	12%	41	4%
Between 61 and 90 days	40	4%	27	2%
More than 91 days	216	22%	184	17%
Total gross trade receivables past due.....	977	100%	1,078	100%
Provisions for bad Debt	(189)	—	(177)	—
Net receivables.....	788	—	901	—

We also receive guarantees, including sureties issued by primary banks, as collateral for the obligations resulting from supplies to, and receivables from, dealers.

Due to the diverse portfolio of products and services we provide, we believe concentration of credit risk is limited.

On the dealer side, we have a certain degree of concentration offset by bank guarantees, credit limits delivered by credit insurers and the timing of payment of commissions after the activation of a new subscriber. Our assessment of bad debt provision is performed based on an individual basis. A 100% provision is recorded in the case of litigation with a supplier. As of December 31, 2013, such provision amounted to DOP 284 million.

On the post-paid residential subscriber side, concentration of credit risk relating to accounts receivable from subscribers is limited due to our high volume of customers. Provision for post-paid residential subscribers' receivables is performed based on a statistical method, where a rate is applied according to the number of days overdue.

Credit risk relating to cash and cash equivalents, financial deposits and money market funds arises from the risk that the counterparty becomes insolvent and, accordingly, is unable to return the deposited funds or execute the obligations under the derivative transactions as a result of the insolvency. To mitigate this risk, wherever possible, we conduct transactions and deposit funds with investment-grade rated financial institutions and monitor and limit the concentration of our transactions with any single party.

Our maximum exposure to credit risk (not taking into account the value of any collateral or other security held) in the event the counterparty fails to perform its obligations in relation to each class of recognized financial assets is the carrying amount of those assets as indicated on our balance sheet.

Liquidity Risk

We do not have any financial liabilities, derivatives, hedging instruments or finance leases. Liquidity risk arises mostly in connection with all of our payment obligations that result from our business activities.

In general, we manage our liquidity risk by monitoring our cash flow and using a rolling liquidity reserve forecast. Nevertheless, the prime objective of our policy is to minimize risks and not to create or maximize interest earned on cash held in bank accounts. Accordingly, we transfer cash to the current account held by Orange Group, without incurring any additional costs. We have a limited policy for investments with banks, and deposits must be made in the functional currency, with foreign currency deposits made to set up a natural hedge. We manage our cash forecasting to determine a currency split of total cash in each currency in order to ensure that we have sufficient committed facilities to meet our liquidity needs.

Critical Accounting Estimates

In preparing the financial statements, we make estimates, insofar as many elements included in the financial statements cannot be measured with precision. These estimates are revised if the underlying circumstances evolve or in light of new information. Consequently, such estimates made as of December 31, 2013 and 2012, may subsequently be changed.

We also use our judgment to define appropriate accounting policies to apply to certain transactions when the current IFRS standards and interpretations do not specifically deal with related accounting issues.

The underlying assumptions used for significant estimates are outlined below:

<u>Estimate</u>	<u>Nature of estimate</u>
Revenue	(i) Identification of separable components of a bundled offer based on the individual components' relative fair value. (ii) Period of straight-line recognition of revenue relating to invoiced service access fees depending on the nature of product and historical contractual relationship. (iii) Reporting of revenue on a net versus gross basis (depending on an analysis of ODO's involvement as either principal or agent).
Purchases and other expenses	Provision for claims and litigation: assumptions underlying legal assessment and risk measurement.
Property, plant and equipment, intangible assets.....	Assessment of assets' useful life based on assessment of the technological, legal or economic environments.
Income tax	(i) Assumptions used for the computation of the income tax charge to be recorded in the financial statements, together with the technical merit of tax positions (ii) Assumptions used for recognition of deferred tax assets arising.

INDUSTRY AND MARKET OVERVIEW

Introduction

We primarily provide cable and fiber-based services comprising high-quality pay television, high-speed broadband internet, fixed-line and mobile telephony to residential customers, and, in certain countries, mobile and fixed-line enterprise telecom services to corporate and government customers. Across geographies, we benefit from an attractive competitive environment given the superiority of the offering we can provide through our cable and fiber networks, of which we have significantly invested, as well as our advanced mobile networks. This has enabled us to (1) develop strong positions in multiple play segments as selling various services as part of bundles has become a growing trend in the markets in which we operate and (2) grow our market share in mobile telephony across our markets (France, Portugal, Israel, Dominican Republic and other geographies).

Pay Television

Cable is the leading platform to distribute pay television in Western Europe and the United States, with a few exceptions, for example in Italy where cable has not been introduced. Technologies that compete with cable include satellite, IPTV, “over the top” (“OTT”) television and DTT. We believe that cable has certain advantages over these technologies, notably in terms of availability of interactive features, image quality and number of channels. Cable is only matched in quality by IPTV and OTT television when these technologies are delivered over fiber-to-the-home (“FTTH”) networks. FTTH networks benefit from substantial bandwidth capabilities that are able to cope with the simultaneous provision of high-speed broadband and high-definition television services.

2014E Pay-TV Platforms—Western Europe and the US

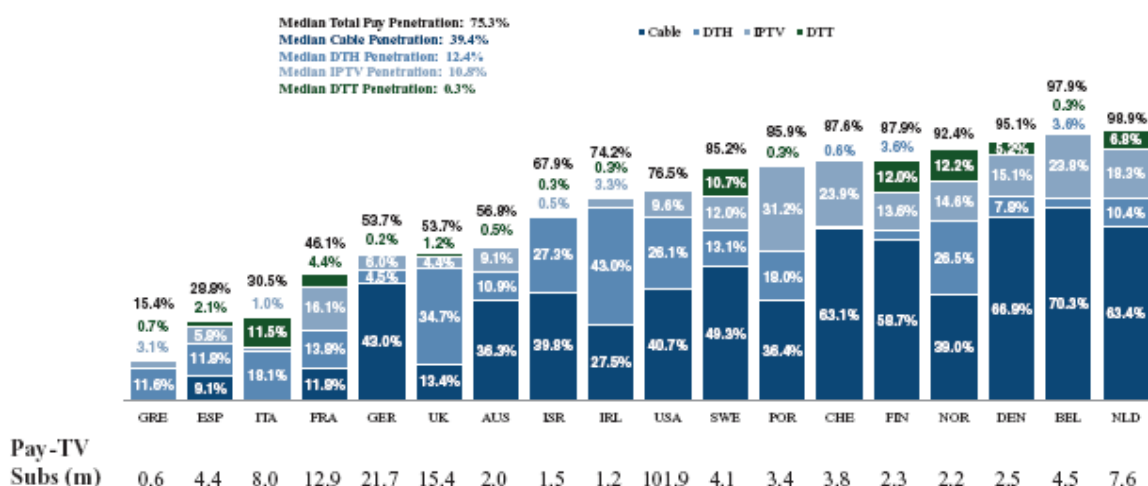

Source: Ovum Research

Satellite operators distribute digital signals nationally via satellite directly to television viewers. To receive programming distributed via satellite, viewers require a satellite dish, a satellite receiver and a set top box. Pay television services provided via satellite typically require the viewers to use a conditional access smart card. Satellite providers of free to air satellite services typically do not have strong relationships with the viewers using their service as they do not receive subscription or other fees from them.

Satellite distribution has a number of competitive advantages over cable television services, including a broader range of programs available to a wider geographic area, especially rural areas. Given the lack of an integrated return path, however, satellite struggles to deliver easy to handle interactive television services, including VoD services, to subscribers who do not have a broadband internet connection. We believe that satellite has the following additional disadvantages compared to cable: (i) higher up front cost of procuring and installing a satellite dish, as compared to the “plug and play” convenience of cable television; (ii) absence of an on going maintenance service, which cable network operators can offer to their subscribers; and (iii) vulnerability of satellite reception to external interference, such as adverse weather conditions.

DTT based pay television packages benefit from the wide coverage of the terrestrial platform but suffer from the structurally limited number of channels available on DTT and the lack of interactive features. Consequently, the success of pay DTT has been limited, even in geographies where free DTT is the primary television platform.

IPTV and OTT television are highly attractive ways of providing television content except when they rely on DSL networks. IPTV and OTT television that rely on DSL networks present a number of disadvantages compared to cable. For example, adding television services over a DSL network strains the network and decreases the amount of capacity available for other service offerings, particularly bandwidth intensive broadband internet. Under currently available technology, we believe that DSL based triple-play providers will have difficulty providing the same level of services that can be provided over fiber networks (in particular, for HDTV, viewing of TV and VoD on multiple screens or TV and VoD simultaneous viewing and recording) without having to make significant investments in extending fiber closer to the subscriber's home. When such investments in fiber are made, notably through FTTH networks, IPTV and OTT television are able to offer high quality television to viewers.

Services provided via cable and FTTH networks are characterized by easy to use technology, the efficient installation of customer equipment and the reliability of a protected signal delivered directly to the home. Given the trend towards offering bundled media and telecommunications services, the market share of pay television distribution is expected to benefit from cable and fiber's ability to deliver triple-play services with high bandwidth, high-speed and bi-directional capacity. On a standalone basis, namely without a broadband internet connection, the number of advantages of bi-directional capabilities of digital cable television over DTH are substantial for both the users and the cable operator. Digital cable subscribers can order VoD products and use interactive television while the cable operator is able to track usage patterns and enable their customers, the television channels, to target advertising to customers more efficiently.

Broadband Internet

The main broadband internet access technologies are DSL and cable, with DSL being the leading platform in a number of countries for historical reasons stemming from the fact that internet access was initially provided on telephony copper lines but is now increasingly provided on FTTH networks. We believe that increasing demand for very-high-speed broadband internet to cope with advanced applications (multi screen, multimedia) requiring higher bandwidth and greater download speeds offer a sizable growth opportunity for cable- and fiber- based technologies in the near term. We expect substantial growth in demand for very-high-speed internet and believe that we are well positioned to benefit from this trend, given that cable networks enable us to offer download speeds of at least 100 Mbps to a majority of homes passed in our footprint. According to IDC (IDC European Telecom Services Database Q3 2014, November 2014), total spending for VDSL, Docsis 3.0 (Cable) and FTTP (Fiber-to- the-premises), will increase 2.2 times between 2013 and 2016 in Western Europe. We believe our cable and fiber-based networks will be able to handle this increase in demand with limited additional upgrades. In contrast, many DSL based operators in some of our geographies of presence would need to make substantial investments in fiber to meet customer needs, although it is possible, in some areas coverage areas, to upgrade DSL networks to fiber for a limited cost. For instance, we have identified such areas in over 450,000 homes currently passed by our DSL networks in Portugal.

2014E Fixed Broadband Platforms—Western Europe and the US

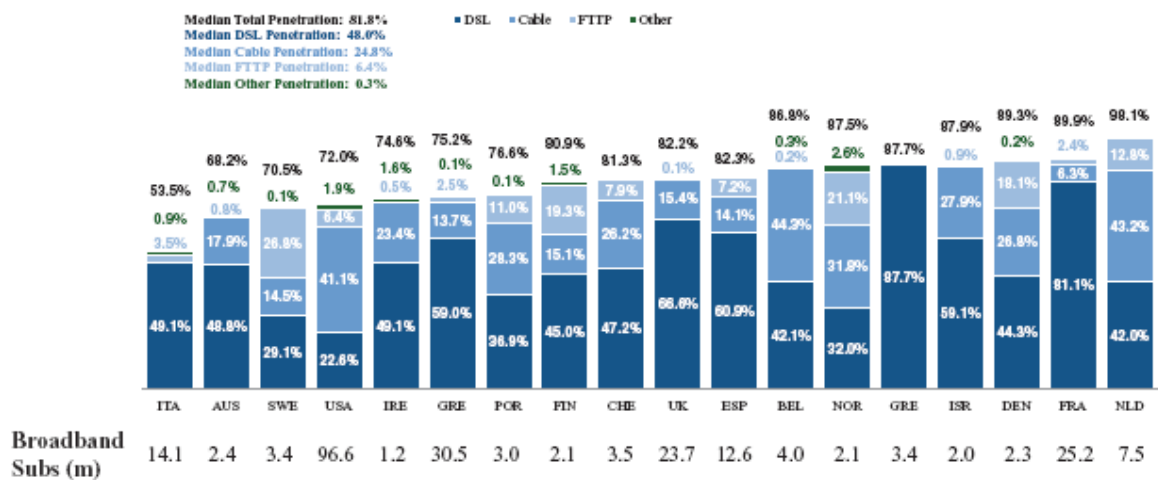

Source: Ovum Research

The existing DSL infrastructure offers consumers maximum speeds of 28 Mbps while cable currently offers consumers maximum speeds of up to approximately 300Mbps on U.S. Docsis 3.0, 360 Mbps on Euro Docsis 3.0 and up to 1 Gbps on FTTH networks. For most users, the actual speed provided by DSL is lower than the advertised maximum speed as the speed is dependent on the distance between the end-users' premises and DSL hubs. Furthermore, the maximum download speed of DSL networks has to be shared between broadband internet and competing simultaneous users of the line, such as IPTV. According to the "Quality of Broadband Services in the EU" report by the European Commission (published in October 2013), cable is estimated to achieve 89.5% of advertised download speed, while DSL based services achieved only 63.8% of advertised download speed.

FTTH technology, which requires a direct fiber connection to the home of the user, currently offers consumers maximum speeds of 1 Gbps, with an estimated achievement of 82.7% of advertised download speeds according to the "Quality of Broadband Services in the EU" report by the European Commission (published in October 2013). A substantial challenge facing the expansion of FTTH or FTTB is that introducing such technology is capital and time intensive and requires significant digging and rewiring, with the exception of certain areas and buildings where upgrades can be performed at a limited cost. For example, in certain areas of our networks in Portugal we are currently upgrading 450,000 DSL-based homes to FTTH (in addition to our current 1.7 million FTTH homes) through an agreement with Vodafone to reduce the upgrade costs.

Cable networks are able to deliver consistent speeds irrespective of the distance to the customer, unlike DSL. We are currently able to offer download speeds of at least 100 Mbps to all Docsis 3.0 and FTTH-enabled homes passed in our footprint.

The Docsis 3.1 standard, which is being developed by CableLabs, is a new Docsis specification enabling higher spectral efficiency support of up to 10 Gbps downstream and 1 Gbps upstream speeds. Docsis 3.1 is expected to work on existing hybrid fiber coaxial (HFC) plant and be backwardly compatible with previous Docsis standards. This double backward compatibility will allow a smooth migration strategy and no plant changes required to deploy Docsis 3.1 equipment. Furthermore, limited investment will be needed to further maximize the capacity in the future. Trials are planned for 2014 and commercially available products are expected in 2015.

VDSL2 is the latest and most advanced technology for DSL broadband internet wireline communications. It was originally designed to support the wide deployment of triple-play services such as voice, video, data, HDTV and interactive gaming and was intended to enable operators and carriers to gradually, flexibly, and cost efficiently upgrade existing xDSL infrastructure. VDSL2 allows the transmission of asymmetric and symmetric aggregate data rates of up to 200 Mbps downstream and upstream on twisted pairs using a bandwidth up to 30 MHz and further, allows for significantly lower signal deterioration caused by the distance between the cabinet and the customer's premises when compared to older DSL technologies. VDSL2 enabled networks could theoretically allow for up to 100 Mbps at 0.4 kilometers, 40 to 50 Mbps at 0.7 kilometers and approximately 30 Mbps at 1 kilometer.

Cable allows parallel usage of Broadcast TV and High Speed Broadband Internet

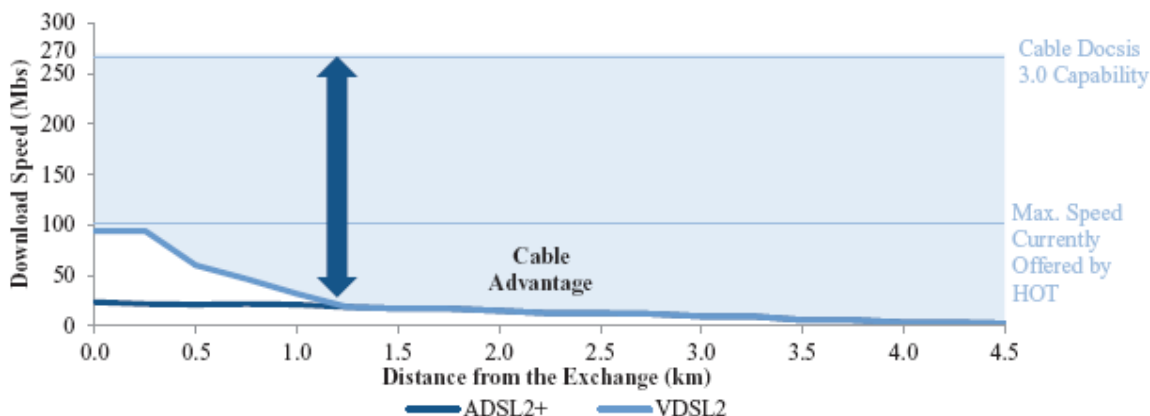

Fixed-line Telephony

Traditional switched voice lines have been declining steadily in recent years as they are replaced by VoIP lines. More generally, fixed-line telephony has become a commodity product that is now bundled into multiple play packages. Accordingly, fixed-line services have become dependent on the quality of the broadband internet offering. Flat rate

pricing for fixed-line telephony is now the market standard. Despite these changes, the decline in use of fixed-line telephony has been slow as most households still maintain a fixed-line at home.

Mobile Telephony and Mobile Broadband Internet

Consumption of mobile telephony and data services has continued to rise globally, driven by a growing penetration and a wider availability of smart phones. Mobile internet traffic is forecasted to grow at an average rate of 61% between 2013 and 2018 according to the Cisco VNI 2014 study, mainly driven by the development of smartphone devices supporting multiple wireless technologies. As mobile internet usage is mainly in the vicinity of home or office, we believe that operators' success in the mobile telephony services business will largely rely on their ability to access a high capacity backbone with compelling mobile tower backhaul offload solutions and a strong integration of their mobile telephony offers with residential broadband based offload capabilities to cope with increasing data consumption.

Despite this general trend, each mobile telephony market has a different structure and dynamic, depending on a variety of factors including, among other factors, the number of mobile network operators versus mobile virtual network operators, penetration of post paid versus pre paid subscription, regulation, available spectrum, commercial strategies of operators such as handset subsidies. The success of mobile operators in the various markets is largely dependent on the overall environment and its competitive advantages to its competitors.

In light of the various trends and the importance of the market structure for successful mobile operations, in order to reliably take advantage of the fixed mobile convergence, we have decided to implement a versatile mobile strategy. As part of this strategy, we own and operate a mobile network in Israel and we expect to benefit from synergies with our scalable cable networks in Israel. Additionally, we complement our fixed-line products with mobile offerings through a Mobile Virtual Network Operators ("MVNO") arrangement in Belgium.

Fixed-line Enterprise Telecom Services

We provide B2B telecom services, including voice and data to Enterprise customers, in a number of our geographies. We are increasingly migrating our Enterprise customers from voice-only products to integrated systems involving data connectivity, ICT applications and cloud-based solutions. We believe our network infrastructure and pooled experience across the Altice Group give us a competitive advantage in this segment.

1. Portugal

Macroeconomic Overview

Following the PT Portugal Acquisition, Portugal will become our largest operating market. According to the IMF, Portugal has a population of approximately 10.6 million and 3.9m households as of December 2013, and the population is expected to grow at an average rate of 0.1% per annum from 2014 to 2019.

Portugal is a developed market economy with a GDP per capita in 2013 of \$23,068 as compared to \$44,999 for Germany, \$39,372 for the UK and \$44,099 for France. In 2013, Portugal's economy contracted by 1.4% according to the IMF due to the ongoing fiscal consolidation and both weak domestic and external demand. This compares to GDP growth of 0.5% for Germany, 1.7% for the UK and 0.3% for France during the same period. Nevertheless, there are early signs of recovery in economic activity. According to the IMF, Portugal's GDP is expected to grow at 1.0% in 2014 and at 1.5% in 2015. This is in line with other developed European economies such as Germany, which is forecast to grow 1.4% and 1.4%, the UK, which is expected to grow 3.2% and 2.7% and France, which is expected to grow 0.4% and 1.0%, respectively over the same periods, according to IMF.

Recently, Portugal has regained access to the sovereign bond markets at more favorable interest rates. Portuguese 10 year sovereign bonds yielded 2.6% as of January 6, 2015, which compares favourably with Germany, France and the UK with respective sovereign yields of 0.5%, 0.7% and 1.6%. Furthermore, contagion from the collapse of Banco Espirito Santo has been fully contained. Moody's has published that it expects no negative impact on Portugal's macro recovery or its sovereign credit rating (BB/Ba1). This positive trend in government financing is expected to benefit private financing for both companies and consumers.

Similarly, Portuguese unemployment has shown signs of improvement in recent quarters, having declined from a peak of 17.5% in March 2013, to 13.1% as of September, 2014 (Source: Instituto Nacional de Estatística). This compares with unemployment rates as of September 2014 of 6.6% in Germany (Source: IMF), 10.1% in France (Source: IMF), and 6.2% in the UK (Source: IMF).

The improved macroeconomic conditions have had a positive impact on consumer confidence, which has increased from (56.6) in January 2012 to (21.4) in November 2014 (based on an index of 100) according to Instituto Nacional de

Estadística. Finally, given Portugal's significant household savings rate of 15.3% for 2013 according to IMF, as compared to 24.0% for Germany, 10.0% for the UK and 20.7% for France, there is room for further upside in consumption if confidence continues to improve strongly.

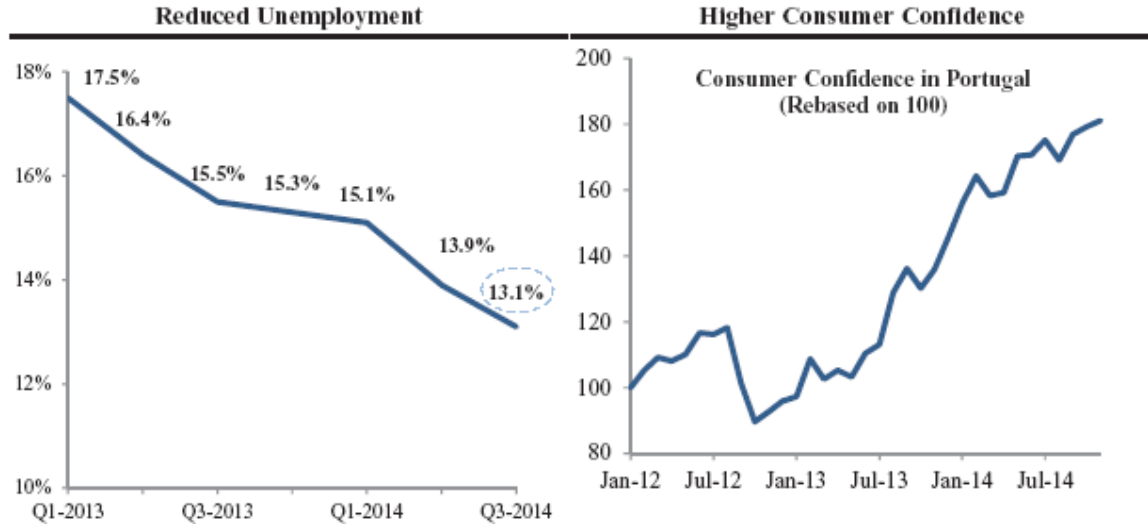

Source: Instituto Nacional de Estatística

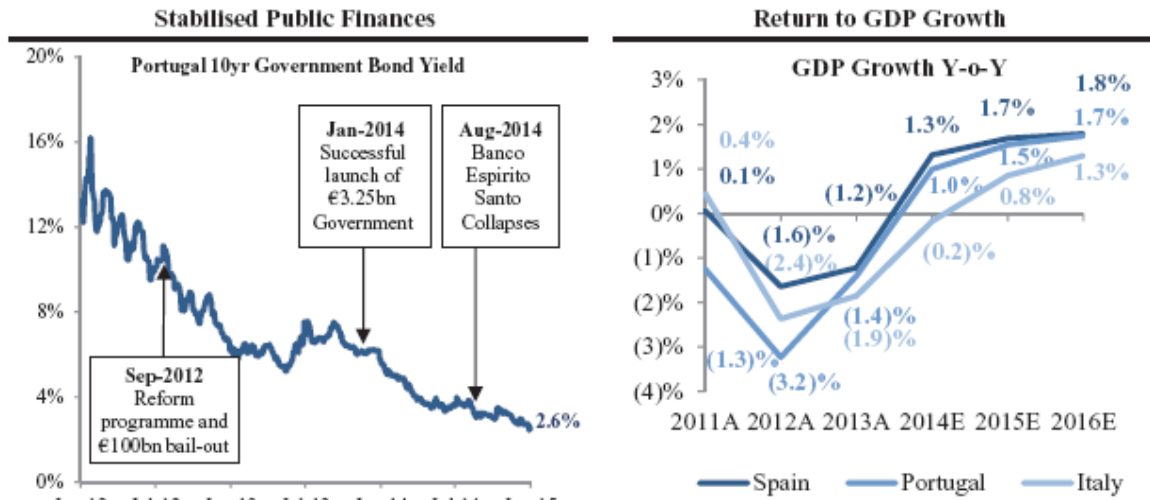

Source: Datastream as at January 6, 2015, IMF

Competitive Overview

Below is an overview of Portugal Telecom's main competitors in Portugal:

Market Shares by Subscribers in Portugal (2013)

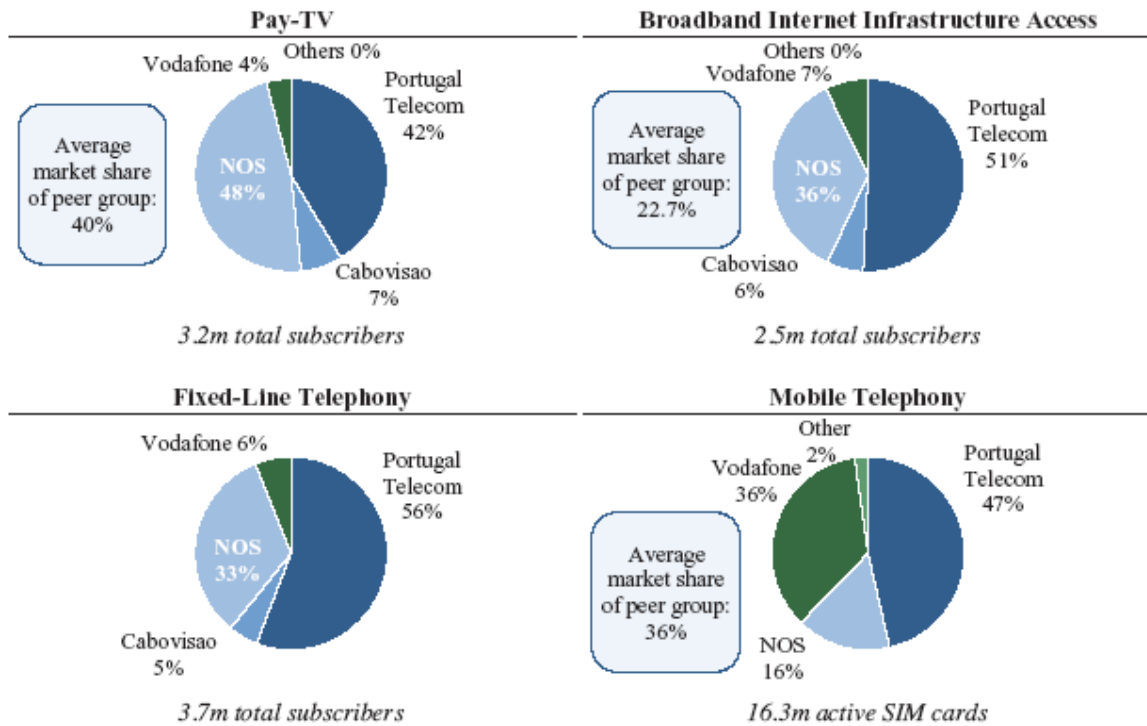

Source: Company filings, TeleGeography, Anacom, Ovum Research.

Note: Peer group for PAY-TV and Broadband includes Virgin Media, Telenet, Com Item, Ono, Ziggo, KDG and HOT (Market shares 2013 in their respective main country of operations). Peer group for Mobile includes Deutsche Telekom, Telefonica, Telecom Italia, KPN and Vodafone (Market shares 2013 in their respective main country of operations).

1.1 Pay Television

According to Ovum Research, Portugal has an estimated 3.4 million pay television subscribers as of year ending 2014, and an 85.9% penetration rate, comparable with the most advanced EU peers. The penetration rate is expected to reach 98% by 2017 (Source: Ovum Research). Pay television penetration has been rising over the past three years driven by the high demand for a broad range of pay television channels and the relative weakness of free terrestrial television which only transmits five channels. Pay television has historically been primarily provided over the cable platform, which has a higher roll out rate than many Western European countries, with DTH, a complementary platform in rural areas, and more recently, IPTV, primarily in areas where fiber is present. Following the PT Portugal Acquisition, most of the pay television market will be divided between two players: NOS (formerly known as ZON Optimus), the largest player by number of subscribers, and Altice Portugal. Vodafone is a third service provider, but it has a limited coverage in rural areas. Based on Anacom research, excluding other small providers, as of December 31, 2013, NOS, PT, Cabovisao and Vodafone had approximately 48%, 42%, 7% and 4% of market share nationwide, respectively. This represents a substantial improvement for PT Portugal as compared to its market share of 14% in 2008. In recent years, PT Portugal has been gaining market share due to the provision of local and original content as well as innovative features (e.g. multi-screen and non-linear content). PT Portugal has primarily offered low-priced IPTV, predominately in fiber areas and to a lesser extent on its DSL network; however, it also has a DTH offering for rural areas where its DSL network suffers from technological limitations. PT Portugal's IPTV offering, sold primarily as part of triple-play packages, has historically not taken customers away from cable. However, it has driven an increase in pay television penetration. Pay television ARPU has increased from €24.9 per month in 2011 to approximately €25.5 per month in 2013, according to Ovum Research.

The Pay-TV market generated revenues of €1.0 billion in 2013 and is forecasted to grow at a 4% CAGR from 2014 to 2017, according to Ovum Research.

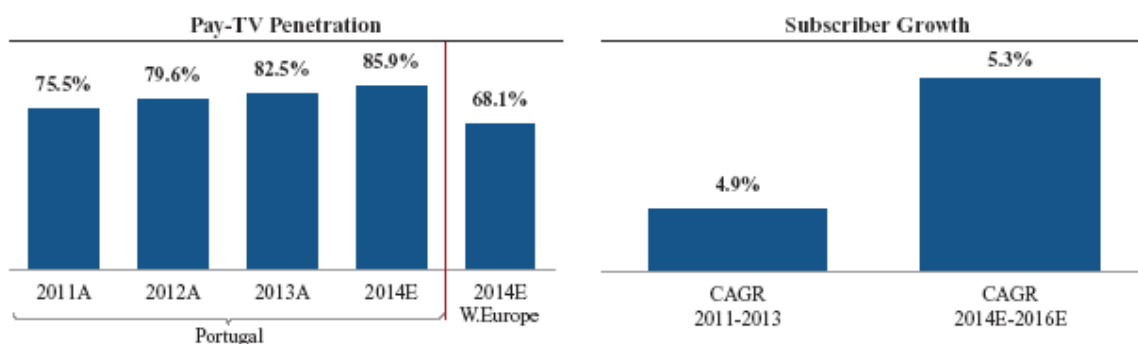

Source: Ovum Research

1.2 Broadband internet

Introduction

According to Ovum Research, Portugal has an estimated 3.0 million broadband internet subscribers as of year ending 2014, and a penetration rate of 76.6%, slightly lower than the Western European average of 80.3%. Penetration is nonetheless forecast to increase, and is expected to reach a level of 79.0% by 2018, according to Ovum Research estimates. There are a number of operators providing broadband internet services to residential customers in Portugal. Pro forma for the PT Portugal Acquisition, the incumbent communications operator and historical monopoly in fixed-line telephony and broadband internet access, Altice Portugal will have a leading market share of 57% as of December 31, 2013, comprised of 51% for PT Portugal and 6% for Cabovisao. PT Portugal's market share has improved substantially from a market share of 42% in 2008. The challenger in the market, NOS has grown its broadband internet presence on the back of a Docsis network, with a footprint passing 47% of the Portuguese population as of February, 2014, and 7% for its FTTH network. According to Anacom, NOS had a market share of 36% as of December 31, 2013. The Portuguese broadband market has strong growth prospects given penetration upside potential. Growth is also expected to be driven by upgrading to higher speed offerings, based on a cable or fibre network infrastructure. According to IDC (IDC European Telecom Services Database Q3 2014, November 2014), the number of B2C subscribers to internet accesses is estimated to grow at 3.0% per annum (2014 to 2016) and ARPUs at 0.1% (2014 to 2016), both metrics being in line with the Western European average.

In 2013, the B2C internet access market generated revenues of €0.3 billion and is forecasted to grow at 2.4% from 2014 to 2018 (Source: IDC European Telecom Services Database Q3 2014, November 2014).

Network Infrastructure

The quality of the network infrastructure underpinning the broadband internet access product is an important asset for operators. Pro forma for the transaction, of the 3.9m primary households in Portugal, Altice Portugal covers almost all homes: 1.7 million households are passed with FTTH (planned to increase to 2.1m following the network sharing agreement with Vodafone to pass an additional 450,000 homes). PT Portugal is additionally the sole infrastructure provider in some rural parts of Portugal, mainly with DSL. NOS covers approximately 3.3 million households with a hybrid fiber and HFC network, and Vodafone covers 1.0 million homes with fiber (with a plan to increase to 2.0 million by the end of 2015). Currently, PT Portugal's penetration of FTTH as a percentage of homes passed in its country of operation is 43%. This will be further extended to 54% of homes passed, following the rollout of a further 450,000 homes as part of a network sharing agreement with Vodafone. This is a higher level of penetration than for many other European telecom companies. Furthermore, as of December 31, 2013, 28.3% of PT Portugal's PAY-TV subscribers were connected through its FTTH network.

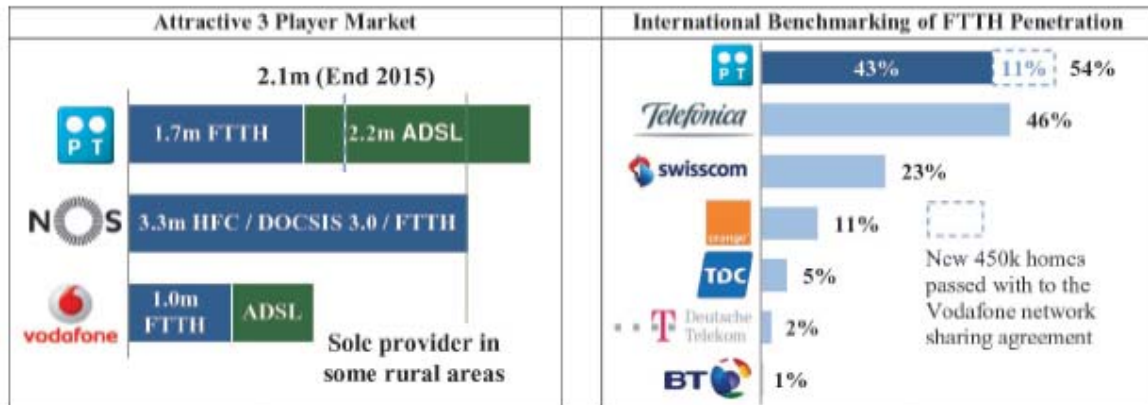

Source: Company information
 Note: Homes passed, in million

Source: Company information
 Note: Based on the latest reported figures. Based on the key country of operations (Telefonica: Spain; Swisscom: Switzerland; Orange: France; TDC: Denmark; Deutsche Telekom: Germany; BT: UK)

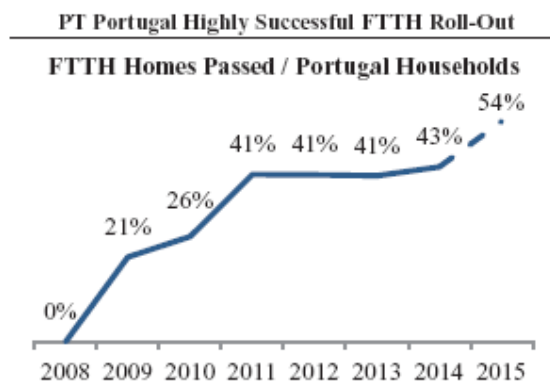

Source: Company filings, Ovum Research

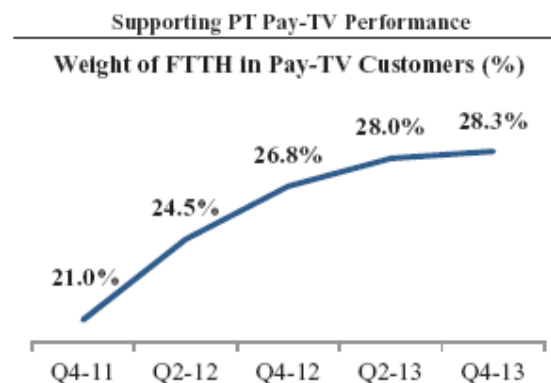

Source: Company filings

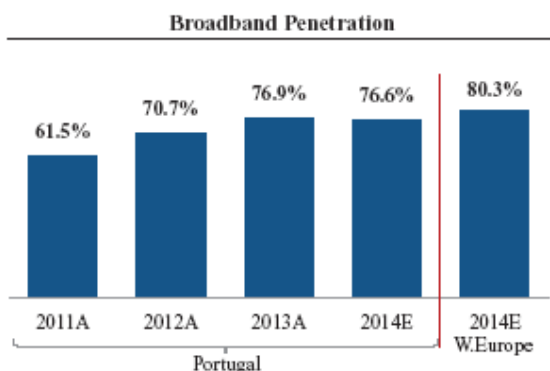

Source: Ovum Research

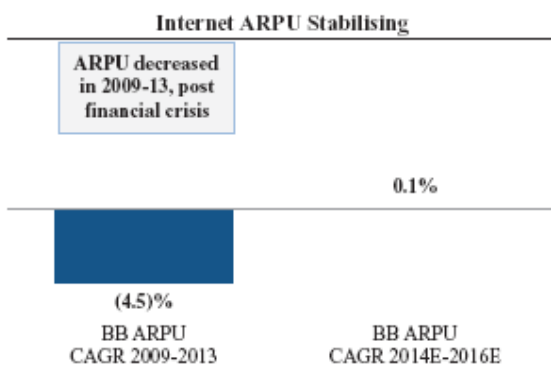

Source: IDC European Telecom Services Database Q3 2014, November-2014

1.3 Fixed-line Telephony

According to Anacom, Portugal had 3.7 million fixed-line connections as of December 31, 2013. The penetration rate was 87.4%, compared to the Western European average of 88.6% (Source: IDC European Telecom Services Database Q3

2014, November 2014). Penetration has been increasing since 2009, primarily driven by NOS's drive to up-sell fixed telephony. At the same time, PT Portugal's number of subscribers remains stable due to an increase in multiple-play penetration. PT and NOS are the leading players with market shares of 56% and 33%, respectively, as of December 31, 2013.

According to IDC, in 2013, the fixed-telephony market generated revenues of €0.6 billion and is forecasted to decline at 5% per annum from 2014 to 2018 (Source: IDC European Telecom Services Database Q3 2014, November 2014).

1.4 Mobile Telephony and Data

Introduction

According to Anacom and Ovum Research estimates, the Portuguese mobile market had 16.3 million mobile subscribers, representing a penetration level of 154.0% as of September 30, 2014, as compared to a Western European average of 135.3%. As of December 31, 2013, in Portugal, 3G and 4G represented 71% of the subscriptions (Source: Ovum Research).

PT Portugal is strongly positioned as the market leader with 47% market share, significantly ahead of Vodafone with a market share of 36%, followed by NOS with a market share of 16%, as of December 31, 2013. This introduction of PT Portugal's quad-play offer M₄O in January 2013 has helped accelerate market convergence and has led to a marked increase in market share for PT Portugal from only 40% as of December 31, 2012. All three players introduced 4G at the beginning of 2012. Portugal Telecom covers 95% of the population with 4G as of the end of 2014 as compared to 90% for NOS.

The market has low mobile termination rates ("MTRs") by European standards. MTRs in Portugal are currently at €1.27 eurocents/minute and expected to decrease to €1 eurocent/minute by the end of 2014 as compared to €3.50 at the end of 2011, which currently is among the lowest levels in Europe. Furthermore, Portugal is a primarily pre-paid market with 65% pre-paid subscribers (as at September 2014), as compared to 35% for the Western European average. Since pre-paid subscribers typically have a lower ARPU as compared to post-paid subscribers (as depicted in the chart below), overall blended ARPU in the Portuguese mobile market is among the lowest in Europe at €12.0 per month versus Western European average ARPU of €21 per month. Migration from pre-paid to post-paid customers, a trend which is already established based on the post-paid penetration level of 53.8% (as of September 30, 2014) as compared to 47.4% as of December 31, 2013, represents an upside opportunity for average ARPU in the market. Finally, the contribution to blended ARPU from data has been increasing over time, and represented 37% as of December 31, 2013, which is still lower than the Western European average of 42%, according to Ovum Research. Similarly smartphone penetration of 50% as of December 31, 2013, suggests a small upside when compared to the European average of 51%.

In 2013, the mobile market generated revenues of €2.4 billion and is forecasted to decline at 1% CAGR from 2014-2018, according to Ovum Research.

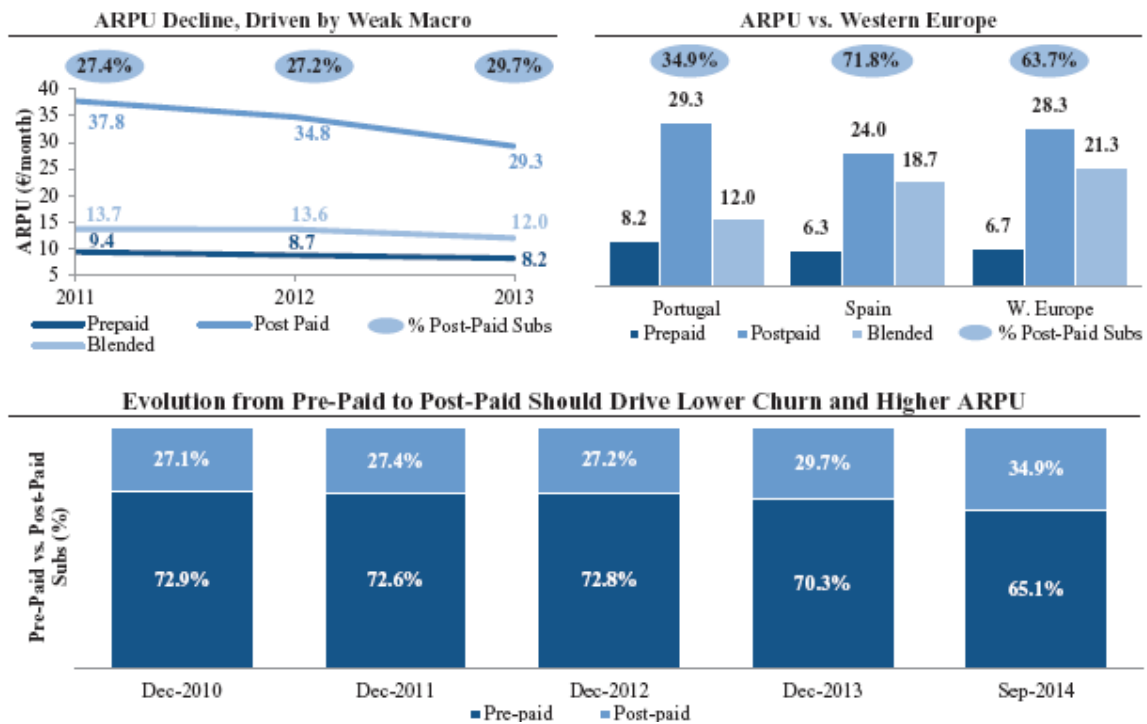

Source: Ovum Research

Access Network Topology—4G As of end of 2014

	Covered Area (%)	Covered Population (%)
Continental Portugal.....	76.1%	95.3%
Madeira.....	61.4%	93.1%
Açores.....	50.2%	79.0%
Total.....	75.3%	94.8%

Source: Company Information

1.5 Bundling

As a consequence of consumer preferences and the parallel consolidation of fixed and mobile players, Portugal's telecommunications market has been transitioning towards convergence relatively faster than in other European markets, with an increasing number of residential and B2B customers taking triple-play and quadruple-play services from the same operator (such as the M₄O offer of PT). From an operator perspective, offering bundled services from a single point of contact helps increase ARPU, improve customer loyalty and reduce churn. This trend favors integrated players with state-of-the-art network and IT platforms that are able to offer innovative bundled offerings to customers.

Portugal Telecom's strategy has been in line with such convergence trend with the launch of its M₃O and M₄O offer, which have been adopted by 1.0 million RGUs and 2.2 million RGUs, respectively by June, 2014.

As of September 30, 2014, PT Portugal's triple-play and quadruple-play penetration of its unique subscribers was 51.3% for PT; NOS triple-play and quadruple-play penetration represented 70.5% of its unique subscribers as of September 30, 2014. PT Portugal has successfully grown its share of subscribers in the triple play market in recent years, from 49% as of December 31, 2011 to 56% as of June 30, 2014. Nevertheless, PT Portugal's revenue generating units per unit subscriber of 2.20x as of September 30, 2014 was lower than certain key peers in other geographies. This suggests potential for further upside in the penetration of bundled services. Growing the penetration of bundled solutions remains a key strategy in growing ARPU and reducing churn.

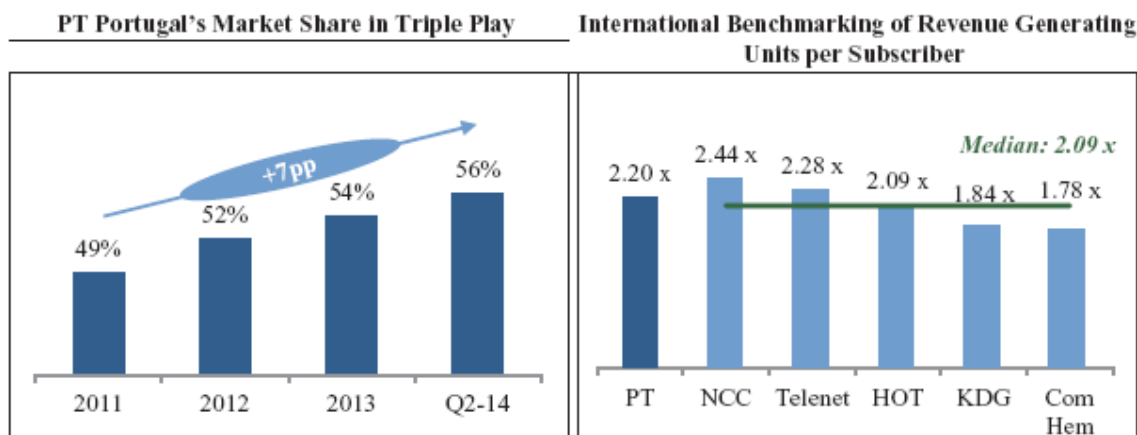

Source: Company information and company filings

1.6 Enterprise

Following the PT Portugal Acquisition, we will own the largest and second largest B2B telecom providers in Portugal under the PT Portugal and ONI brands respectively. In 2013, the market addressable by PT Portugal was estimated at approximately €1.7 billion, based on Analysys Mason estimates. Our main competitor in these markets is NOS, a newcomer to the B2B telecom market with an opportunistic strategy leveraging fixed and mobile networks, Vodafone, a mobile telecommunications company, and AR Telecom. PT Portugal's market share for the B2B market was 48% as of December 31, 2013, according to Analysys Mason based on revenues.

Optimus has historically been one of the most aggressive competitors regarding pricing and through its merger with ZON has gained access to an enhanced backbone, last mile access and an enhanced ability to address both large and smaller companies. Vodafone and AR Telecom have adopted different strategies to realize B2B opportunities, but have both had limited success to date due to lack of knowledge of fixed networks and lack of credibility in the corporate market.

There is a general trend in the Enterprise segment to migrate customers away from voice services to higher margin data services and, increasingly, integrated solutions including ICT and outsourcing. Altice Portugal will combine the strengths of PT Portugal and ONI, to capture value from the trend to more data-intensive integrated solutions and to provide converged fixed mobile solutions leveraging our integrated HFC, fiber and 3G and 4G mobile networks. We benefit from a large sales force with strong distribution capabilities in the banking and public administrations sectors and broad supplier relationships, which enrich the range of our services.

In 2013, the Enterprise market generated revenues of €1.7 billion and forecasts that it will decline at a 1% CAGR from 2014 to 2018, according to Analysys Mason estimates.

2. Israel

Macroeconomic Overview

We operate a significant portion of our business in Israel, which has a population of approximately 7.9 million and approximately 2.2 million households, as of December 31, 2013. According to the IMF, between 2010 and 2013, the population of Israel grew at an average rate of 2.2% per annum and is expected to continue to grow at an average rate of 2.2% per annum from 2014 to 2017, thus providing a natural floor to expansion in the number of inhabitants and households, the target market for our cable based and mobile services.

Israel has a developed market economy. In 2010, Israel joined the Organization for Economic Co operation and Development ("OECD") and in 2013 had a GDP per capita (based on purchasing power parity) of \$36,926, compared to other European countries such as \$44,999 for Germany, \$44,099 for France and \$39,372 for the UK, according to the IMF. Since 1991, Israeli real GDP has grown at a rate of 4.4%, according to IMF. This compares favorably as against the average real GDP growth rate in other European countries such as 1.3% for Germany, 1.6% for France and 2.3% for UK, and 2.6% for in the U.S. in the same period. During this period, Israel faced a decline in real GDP for only one year, in 2002. Since the beginning of the global economic slowdown in 2007, the Israeli economy has witnessed a high level of resilience: Israeli real GDP has grown at an average rate of 3.6%. Israel maintains a sovereign A+ and A1 rating from S&P and Moody's, respectively. Israel's real GDP is expected to grow at an average rate of 2.8% per annum from 2013

to 2016 versus an average of 2.8% for the UK and 1.0% for France according to the IMF. Israel also enjoys high levels of literacy, life expectancy and disposable income as attested by it being ranked at 19 on the Human Development Index (“HDI”), ahead of countries such as Belgium, France and Austria. Israel’s economy is diversified and competitive on an international platform with a significant level of exports focused around high technology equipment, cut diamonds and agricultural products. Israel usually posts sizable trade deficits, as it imports crude oil, grains, raw materials, and military equipment, predominately offset by tourism and other service exports, as well as significant foreign investment inflows, which contribute to the balance of payments, and a relatively stable currency.

Evolution of the EUR/NIS Exchange Rate over the last 5 Years

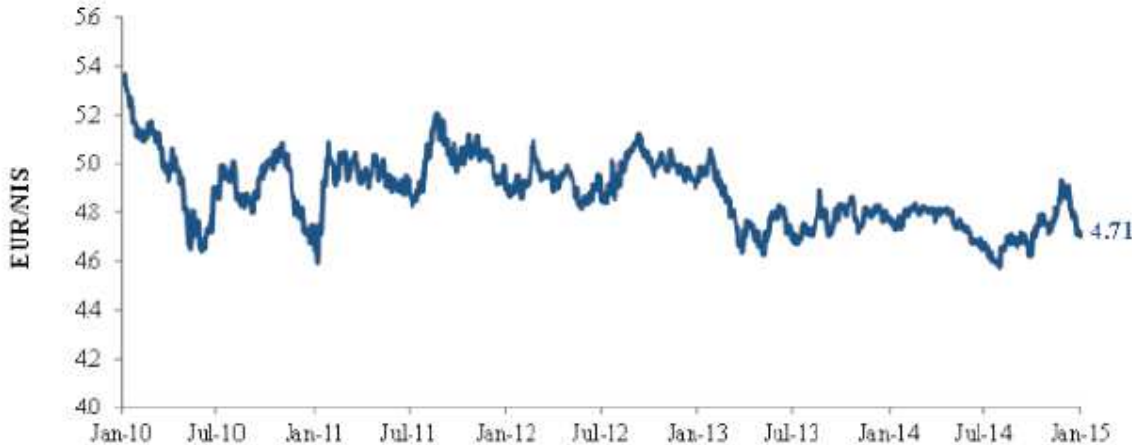

Source: Capital IQ data as at January 6, 2015

The Israeli media and telecommunications markets have, over the past several years, slowly been converging as customers were inclined to subscribe to their media and telecommunications services from a single provider. Israel currently has relatively high estimated penetration rates for pay television, broadband internet infrastructure access and mobile telephony of 67.9% (for 2014), 87.9% (for 2014) and 126.8% (as of September 30, 2014), respectively, according to Ovum Research. This environment fosters a market for packaged offerings or “multiple-play”, whereby television, broadband internet infrastructure access and fixed-line telephony services are bundled into integrated offerings referred to as “dual play” or “double-play” (two services provided together), or “triple-play” (three services provided together). When mobile telephony subscriptions are added to “triple-play” packages, these are known as “quad-play” or “quadruple-play” packages, but currently such packages are prohibited by law in Israel under certain operators’ licenses, including ours.

Side by Side Comparison of Bundles in Israel

Offer	Hot (Cable)	Bezeq (xDSL / DTH)	DTT
Bundling	✓ Triple play	x No triple play packages currently allowed ¹	x No multiple play
	✓ Mobile offered separately	✓ Mobile offered separately	

(1) Subject to imminent change.

The only operator currently offering triple-play packages including pay television, broadband internet infrastructure access and fixed-line telephony in Israel is HOT, with approximately 40% and 44% of its Cable Customer Relationships subscribing to its triple-play offerings, as of December 31, 2013, and September 30, 2014, respectively. While convergence has occurred at a relatively fast pace in a number of Western European markets, notably in France and in the UK, a series of regulations, notably those affecting the integrated telecommunications operator Bezeq’s ability to bundle products, have historically prevented such convergence to occur en masse in Israel, and still are a significant impediment to a broader convergence. On March 26, 2014, the Israeli Anti Trust Commissioner approved the merger between Bezeq and YES and we foresee that following such decision, Bezeq will begin to offer triple-play in the near future. We believe

that offering bundled services allows media and telecommunication service providers to meet customers' communication and entertainment requirements increases customer loyalty and attracts new customers as the value proposition of the offering is enhanced.

Competitive Overview

Cable-based Services Market Shares by Subscribers in Israel (2013)

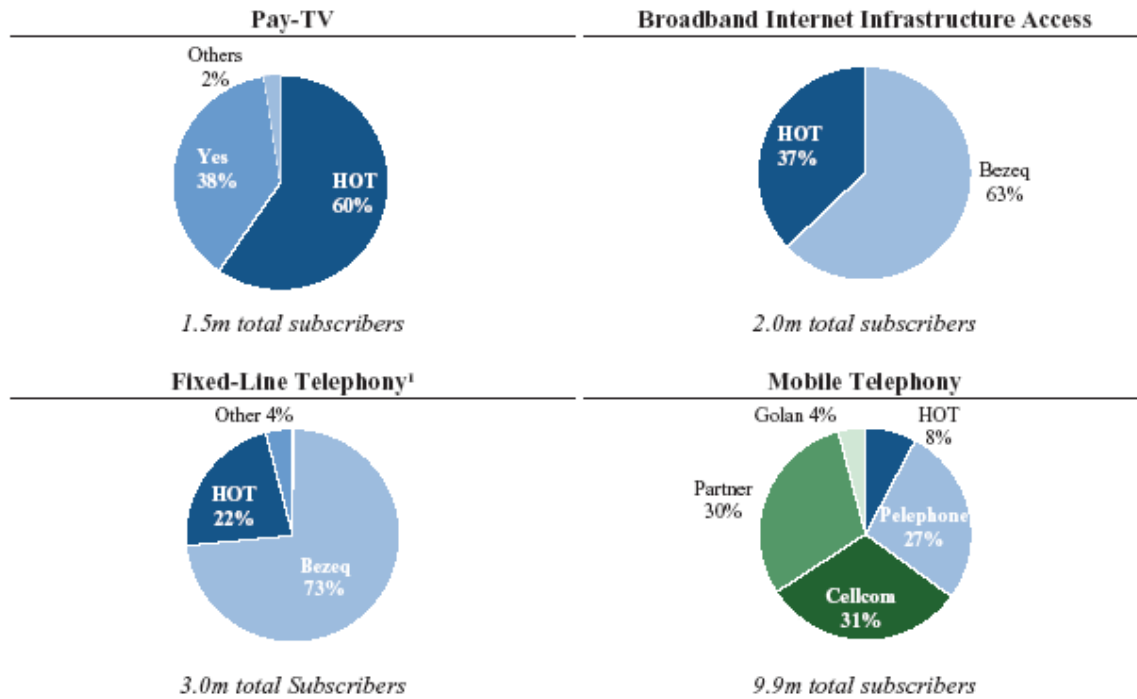

Source: Ovum Research, TeleGeography and company filings

(1) Other include Netvision, Partner/Smile and others, all with relatively small market shares

2.1. Pay Television

Introduction

Israel's primary television platforms are dominated by pay television with relatively limited penetration of free platforms such as terrestrial television or free DTH. As a result of the free-to-air platforms being relatively unattractive (given their access to only six channels offered by DTT) and limited local content for free DTH, Israel's pay television market currently has an estimated penetration level of approximately 68% compared to 46%, 54%, 86% and 88% in France, Germany, Portugal and Finland, respectively, according to Ovum Research (estimated for the year ending December 31, 2014). The Israeli pay television market has been stable by the number of subscribers since 2009 at approximately 1.5 million subscribers. Similar to Western European markets, television consumer behavior in Israel is currently focused on digital, innovative, HDTV and interactive television services such as VoD and "start over".

Israel Pay-TV ARPUs vs. Peer Countries (€ per month) (2014 to 2016 CAGR)

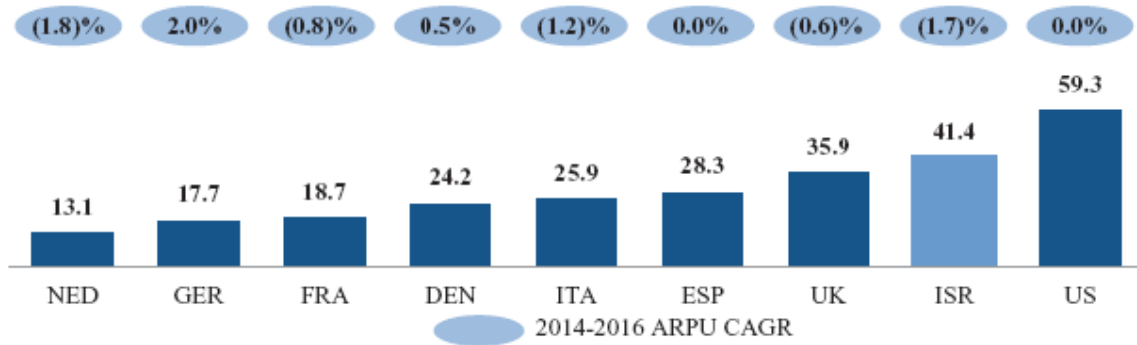

Source: Ovum Research

Most Israeli households subscribe to pay television packages via cable or satellite, mostly digital, provided by HOT and YES, an associate of Bezeq, respectively. Free DTT service started in 2009, but has achieved a limited primary penetration of TV households of approximately 18% based on Ovum Research’s current estimates (estimated for the year ending December 31, 2014), although we believe these numbers include numerous Haredi or ultra orthodox Jewish households who do not watch television. The established pay television operators face competition from free television (including DTT) and alternative ways of accessing television channels (such as “over the top” (“OTT”) television), the competitive advantage of pay television via cable or DTH (reliability, image quality, diversified international and local language content and the ability to offer advanced interactive services among others) and the loyalty of the existing customer base lead to the pay television industry having relatively stable subscription revenues when compared to other countries where competition from other platforms is more prevalent. As of December 31, 2013, the Israeli pay television market had 1.5 million subscribers, 59% of which accessing through cable (HOT) and 41% through satellite (YES).

The penetration of pay television could increase in the coming years as cheaper packages with fewer channels have been recently introduced by HOT and YES.

Offer	Hot (Cable)	Bezeq (xDSL / DTH)	DTT
Television	✓ 78 basic TV channels/20 HDTV channels/67 Premium TV/13 Interactive channels	✓ 45 basic TV channels/19 HDTV Premium TV	✓ 6 basic channels x No VoD x No foreign language channels x No premium content
	✓ Standalone VoD	✓ Pay per view	
	✓ A la carte/"TV Everywhere" second screen	x No standalone VoD (without internet)	
	✓ Startover function	x No Startover function	
	✓ Latest generation set-top-box being introduced in 2014 ("LaBox")		
Internet	✓ Up to 200Mbps download speed advertised	✓ Up to 16-100Mbps download speed advertised	x No internet
	✓ Up to 2Mbps upload speeds	✓ Up to 1Mbps upload speeds	
	✓ Effective speed advertised is typically achieved	x Effective speed advertised based on an 'Up to Basis'	
Telephony	✓ Digital telephony	✓ Digital telephony	x No telephony
Bundling	✓ Triple play	x No triple play packages allowed	x No multiple play
	✓ Mobile offered separately	✓ Mobile offered separately	

Source: Company information and Bezeq website

Cable

HOT is the sole cable operator in Israel with a network covering nearly all Israeli homes (a unique situation in OECD countries) and generates revenues principally from subscription fees paid by customers for the services provided. HOT co-develops and co-owns a number of popular shows, movies and series. It offers a number of proprietary channels as part of its packages giving them a competitive advantage. Cable's share of the pay television market has remained relatively stable over the last three years at approximately 60% with total pay-TV subscribers also remaining relatively stable.

Satellite

Satellite television is the main alternative to cable television in Israel. Television viewers can receive free to air or paid satellite television, which is offered by YES. Satellite's share of the pay television market has remained relatively stable over the last three years at approximately 40%. The ARPU generated by satellite television customers has historically expanded at a slower pace than cable ARPU, with forecasts showing a stable satellite ARPU, while cable ARPU is expected to expand, according to Ovum Research, based upon the digitalization and the emergence of a broader offering of channels and additional services. Satellite and Cable ARPUs are expected to grow at 0.1% and 1.3% CAGR respectively from 2014 to 2016, according to Ovum Research estimates.

DTT

Subscribers are also able to receive television services through DTT, an alternative way of watching certain television channels. Current penetration rates of DTT are low due to several reasons: (i) DTT currently offers access to six channels only; (ii) there is no access to premium or thematic content, such as sports, movies or children’s programming; (iii) DTT has no interactive functionalities such as VoD or “start over”; (iv) DTT has limited capacity to transfer significant number of channels simultaneously; and (v) the quality of its transmission can be affected by weather. DTT could become more attractive in the future as a total of two multiplexers (MUXes) allowing for 18 channels have recently been approved by the Israeli government and are being rolled out. The Ministry of Communications expects that in 2014 the DTT platform will offer 18 channels, up from six, for free. The expanded service will use three multiplexes up from the current one. However, we believe that cable television will maintain its advantage over DTT as the increase in the number of channels does not fundamentally address some of the key customer requirements such as interactivity and ability to choose individualized content packages, and DTT channels have struggled to be successful without the revenue generated by customer subscription charges.

Other Emerging Technologies

We face a growing but limited competition from other technologies in Israel when compared to the European markets. Our incumbent competitor is currently lobbying to offer IPTV which is currently prohibited by law. Other players, such as websites and online aggregators of content that deliver broadcasts OTT of existing broadband internet networks may become significant competitors in the future. The full extent to which these alternative technologies will compete effectively with our cable television system is not yet known; however we believe that the international IPTV market will have difficulty impacting the Israeli multichannel TV market due to various reasons, including: (i) the availability of certain local language content available through cable or satellite only; (ii) the quality of the signal on certain DSL enabled connections located far from exchanges; (iii) the inability to access HDTV content on most DSL connections during peak times; and (iv) the ability of cable operators to bundle pay television with other fixed-line products.

2.2. Broadband internet

Introduction

Israel is a mid-sized broadband internet market based on penetration compared to the large Western European or North American peer countries, with approximately 2.0 million broadband internet subscriptions (residential and business) as of December 31, 2013, and 2.0 million as of June 30, 2014. The current broadband internet penetration rate in Israel (being the number of broadband internet subscriptions per 100 households in Israel) is 88%, according to Ovum Research estimates (estimated for the year ending December 31, 2014), compared to 85% as of December 31, 2010. This level is above the Western Europe average of 80% and that observed in Italy (54%), Portugal (77%), and Germany (75%), according to Ovum Research (estimated for the year ending December 31, 2014).

Broadband internet in Israel is uniquely structured as households wishing to subscribe to broadband internet are required to purchase an internet access service from a licensed internet Service Provider (“ISP”) and a broadband internet infrastructure access service from HOT or Bezeq, the only telecommunication operators which own a nationwide physical fixed-line infrastructure.

Side by Side Comparison of Cable-based Services Offerings in Israel

<u>HOT (Cable)</u>	<u>Bezeq (xDSL/DTH)</u>	<u>DTT</u>
✓Up to 200Mb/s download speed advertised	✓Up to 60-100Mb/s download speed advertised	x No Internet
✓Up to 2Mb/s upload speeds	✓Up to 1Mb/s upload speeds	
✓Effective speed advertised is typically achieved	x Effective speed advertised based on an ‘Up to Basis’	

Broadband Internet Infrastructure Access

Currently HOT and Bezeq are the only fixed-infrastructure owners nationwide. HOT uses cable, while Bezeq’s network is mainly composed of DSL technology, although it is currently also building out a fiber network. Growth in the Israel broadband internet infrastructure access market has been driven by (i) the number of subscribers to broadband internet infrastructure access increasing steadily from 1.8 million in 2010 to 2.0 million as of June 30, 2014, and (ii) a significant growth in broadband internet ARPUs.

Bezeq, through DSL, is the leading broadband internet infrastructure access provider in Israel, with 1.3 million subscriptions as of September 30, 2014, including business and residential customers. Including business customers,

Bezeq represents approximately 64% of the total broadband internet infrastructure access market by total number of subscribers as of June 30, 2014 (Source: TeleGeography), which has remained relatively stable over the last three years.

Based on the company’s public filings, Bezeq is currently rolling out a Fiber-to-the-Cabinet (“FTTC”) infrastructure and provides advanced network services such as Next Generation Network, an advanced communication network covering over 98% of Israeli households.

On August 29, 2012, Bezeq announced it has decided to broaden the deployment of the optical fibers so that they will arrive as close as possible to the customers through Fiber-to-the-Home (FTTH) or Fiber-to-the-Building (FTTB), to form the basis for the future supply of advanced communication services and with greater bandwidth than currently provided. As of December 31, 2013, Bezeq had already deployed FTTx to 400,000 households and businesses in Israel and it is planning to have covered 1,000,000 homes and businesses with fiber by the end of 2014.

Our ability to offer the highest speeds in Israel on a large scale allows our customers to connect several devices (such as computers, tablets and smartphones (via Wi Fi connection)) simultaneously without impairing the quality of television signals or the speed and quality of the internet connections. We believe that this differentiates us from our nearest competitors.

As of June 30 2014, we had a market share of 36% of the broadband internet infrastructure market, as compared to a 39% share as of June 30, 2013. Our market share has nonetheless remained stable throughout 2014, and is consistent with our focus on higher ARPU triple-play subscribers.

2.3. Fixed-line Telephony

As of December 31, 2013, there were approximately 3.0 million fixed- line telephony lines in Israel. Subscribers to fixed-line telephony services include households and enterprises. The number of lines has been declining slowly since 2010, which is in line with most Western European countries where fixed-line penetration of households has declined on the back of an increase in number of individuals who use mobile phones only. Bezeq, the incumbent fixed-line telephony service provider in Israel, is the largest provider of fixed-line telephony services, with 2.2 million fixed telephony lines or approximately 73% market share as of December 31, 2013. Also, in line with Western European trends, the incumbent Bezeq saw a decline in its market share over the past years. In addition to Bezeq and HOT, who are by far the largest operators, fixed-line telephony can also be purchased from VOBs who cumulatively hold approximately 4% of the market share. HOT had approximately 22% of the fixed-line telephony market share as of December 31, 2013 and September 30, 2014.

Fixed-Line Telephony Subscribers and Market Share Among Top Two Israeli Players Since 2010

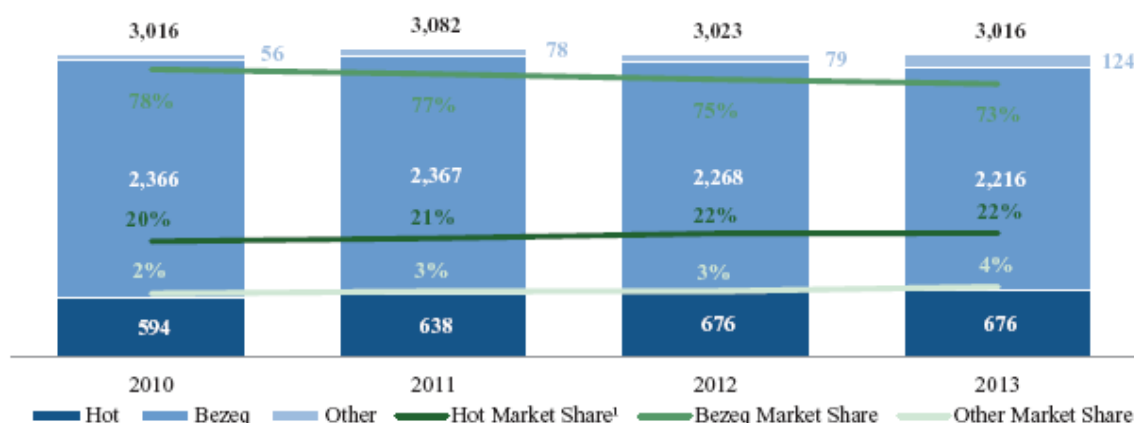

Source: TeleGeography

(1) HOT market share illustratively based on HOT and Bezeq total markets shares

The market for residential telephony in Israel faces pressure from alternative carriers, declining mobile termination and interconnection rates, as well as alternative access technologies such as Voice over Internet Protocol (VoIP) (e.g. Skype). In recent years, fixed-line telephony services have been largely a commodity and uptake has become increasingly dependent on a quality broadband internet offering by the same provider. Fixed-line telephony is increasingly included in bundles which benefit HOT as a result of its ability to provide attractive bundles offerings. Fixed-line telephony has

experienced some price erosion over the past few years, partly driven by a reduction in termination fees and pressure from to bundle discount, and resulted in the decline in Bezeq and HOT's fixed-line telephony ARPUs.

2.4. Mobile Telephony

There were approximately 9.9 million mobile telephony customers in Israel (excluding MVNOs) as of December 31, 2013, and approximately 10.0 million as of September 30, 2014. Penetration was estimated to be 127% as of September 30, 2014 (Source: Company filings, Ovum Research), broadly in line with countries such as Norway, the UK, Switzerland. Approximately 80% of the customers were "post paid" (purchased subscriptions rather than pre paid cards fixed number of minutes of use), according to Ovum Research as of September 30, 2014. On average Israeli mobile phone users spent approximately €17 per month (excluding VAT) on their mobile telephony services in 2013, according to Ovum Research, a relatively modest figure when compared to most Western European and US markets.

Israeli Cellular Telephony Penetration vs. Western European and US (September 2014)

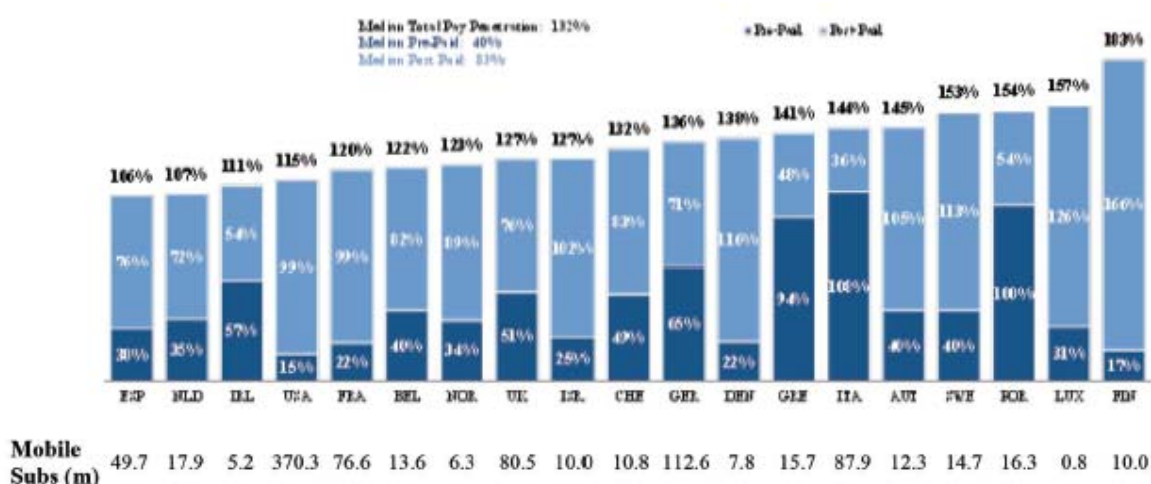

Source: Ovum Research, ARCEP (France)

There are currently five licensed Mobile Network Operators ("MNOs") which offer mobile telephony services to the public and several players who operate MVNOs, although MVNOs currently have insignificant market share of the mobile telephony market. Market shares of the top three mobile operators, Cellcom, Partner Communications and Pelephone (Bezeq), have been relatively stable over the past years at approximately 30% each. New entrants, HOT Mobile (previously MIRS) and Golan Telecom, were granted UMTS licenses in 2011 with services launched in the second quarter of 2012 through a combination of proprietary networks and national roaming agreements with existing operators. As of September 30, 2014, HOT Mobile had approximately 932,000 mobile subscribers, corresponding to a market share of approximately 9% compared to 4% as of December 31, 2011. As of June 30, 2014, the combined ARPU for mobile telephony subscribers of all mobile operators in Israel declined to €16.5 per month primarily driven by a new mobile termination fee regulation in September 2010 which reduced mobile termination rates from NIS 0.25 to NIS 0.0687 per minute from the beginning of 2011, with further reductions to NIS 0.0634 per minute from January 1, 2012 and to NIS 0.0591 per minute from January 1, 2013. The final reduction, to NIS 0.0555 is set to come into force on or about January 1, 2014.

The Israeli mobile communications market is more competitive than some of the markets in Western Europe, notably given the recent legislation, enacted in April 2012, preventing operators from charging exit fees, except in limited circumstances. As a result, the Israeli mobile market now offers fewer barriers to entry for the new mobile license owners HOT Mobile and Golan Telecom.

Ovum Research estimates that the Israeli mobile telephony market will decline at 4.5% per annum between 2014 and 2016, which is consistent with the markets of other countries such as Germany, France, UK and Italy whose mobile markets are expected to achieve declines at 0.6%, 2.5%, 2.6% and 4.0%, respectively.

The Israeli market features lower ARPUs than in most of the other developed markets, which makes mobile telecom services more attractive to consumers.

Mobile Broadband Internet

As of December 31, 2013, there were 5.8 million active 3G mobile subscribers in the Israeli market, according to Ovum Research. Mobile operators' network capability can be further enhanced by Long Term Evolution ("LTE") network roll out, although the Ministry of Communications has not yet tendered for the frequencies necessary for LTE based services, which would enable higher speeds for mobile broadband internet. Mobile broadband internet operators, however currently only offer speeds and capacities that are significantly lower than those offered by cable and DSL operators. As a result, we believe that, in the medium term, HFC cable will be the only broadband internet infrastructure access alternative to DSL with an extensive coverage and high bandwidth for the foreseeable future.

3. Dominican Republic

Industry Overview

The Dominican Republic is the third largest economy in the Caribbean and Central America after Cuba and Puerto Rico, with a GDP of \$61.3 billion according to the IMF, and the third largest country in terms of population after Haiti and Cuba, with a population of 10.4 million according to the IMF. According to the IMF and La Oficina Nacional de Estadística, 32% of the population was living in the Dominican Republic's two main cities, Santo Domingo and Santiago, in 2010. According to the IMF, between 2009 and 2013, the GDP of the Dominican Republic grew at an average rate of 10.3%. The economy is predominantly based on services, in particular tourism. Its GDP per capita, however, is lower than other countries in the region, including Trinidad & Tobago, Panama and Costa Rica, and GDP is expected to grow at 8.3% per annum between 2014 and 2017 according to the IMF. In addition, the Dominican Republic enjoys a strong commercial relationship with the United States, its largest export and import partner. The number of Dominicans residing in the United States has increased by 0.27 million between 2000 and 2012, while remittances into the Dominican Republic from the United States have doubled. These factors are expected to continue help drive personal consumption and usage of telecommunications products and services.

The Dominican Republic telecommunications markets is dominated by Claro, the incumbent owned by the Mexican telecom operator America Movil, and its main challengers, Tricom and Orange, in the fixed and mobile markets, respectively. All three operators own and operate multiple fixed and mobile technologies running in parallel to ensure maximum coverage and reliability to their customers. Other players in the Dominican Republic telecommunications market are relatively small, with less advanced networks and more limited coverage. These include Wind Telecom, a wireless operator, Viva, a mobile operator and Aster, a cable operator.

Mobile Telephony

The mobile market is the largest telecom market in the Dominican Republic. Compared to other Western European markets, the Dominican Republic is characterised by a young population with lower purchasing power. According to Ovum Research, the mobile penetration rate in the Dominican Republic is approximately 111% (as estimated for the year ending December 31, 2014), lower than mobile penetration rates in Brazil, Argentina or Chile. Claro enjoys a 51% market share as of June 30, 2014, followed by Orange (34%), Tricom (8%) and Viva (7%), who re-launched its mobile operations earlier this year. Due to lack of space in the spectrum currently assigned to Altice Hispaniola and Claro, 4G deployment has been slower than initially expected as the two leading mobile operators are currently unable to offer nationwide 4G mobile offers.

The regulator INDOTEL regulates the sector based on what management perceives as an ex-post approach focused on achieving consensus among the various stakeholders. Telecom concession attributions are decided by the regulator based on certain administrative criteria and the renewal of these concessions generate no meaningful incremental fees. Frequency licenses attribution and renewal processes typically occur concomitantly with the telecom concession processes. New frequencies are tendered with several parties typically bidding and the new license attributed to the highest bidder while renewal of frequency licenses gives rise to no incremental fees for telecom operators. Mobile termination rates are determined by bilateral discussions between operators and have decreased by 3.5% annually since 2010. The regulator does not typically impose MTR reductions and favors such bilateral agreements between operators. The law provides for the possibility of MVNOs. From a telecom infrastructure standpoint, the regulator favors passive and active sharing with bilateral negotiation being the preferred route.

In the fourth quarter of 2011, INDOTEL launched an auction for the spectrum in the 900 and 1,700 MHz bands, however that process was put on hold in the first quarter of 2012, following ownership claims of certain frequencies by local TV channels (Arcoiris TV, Colorvision, Supercanal and Satel). The 2011 auction was a sealed bid process in which there was only one round. The auction was to be awarded to the bidder that offered the highest price, together with the best technical offer. In case of equal offers for the same block, a new round of bids was to be launched within two hours. The winning bidder's obligations included providing minimum population coverage of 50% within 18 months and 88% within 36 months in addition to social free lines for five years. Also, the winning bidder was to be obligated to pay the

technical migration of existing frequency users in the granted blocks. Further, the winning bidder was to pay 10% of the offer as a three year guarantee. In 2014, Orange won the 900 MHz auction and Claro the 1,700 Mhz/2,100 Mhz auction, though the award is under investigation for alleged irregularities in the process.

Pay Television, Broadband and Fixed-Line Telephony

According to SNL Kagan, the Dominican Republic has an estimated 31.3% pay television penetration rate for 2014, and an estimated 24.6% broadband penetration rate for 2014 according to Ovum Research. These penetration rates are typically lower than those measured in a number of Latin American countries and evidence significant potential for growth in the Dominican Republic, with penetration rates expected to increase to 33.9% by 2020, according to SNL Kagan. Mobile will play an increasingly important role, with only a third of broadband uptake expected to be attributable to fixed broadband, according to Analysys Mason. In addition, fixed-line telephony is expected to continue to decline going forward, in particular due to ongoing substitution of fixed-line by mobile services, in line with trends seen in other developed economies.

The pay television market in the Dominican Republic is highly fragmented with over 6 pay television operators, although only a limited number operate a two way network, and a handful of other players have a subscriber base exceeding 10,000. Claro and Tricom together represent over 90% market share (66% and 25% market share respectively), as of September 30, 2014, delivering services over IPTV and DTH and cable respectively. Other smaller players include Wind through its MMDS technology (9%), as of the same period.

Broadband internet access is typically delivered by a mix of fixed-line infrastructure and mobile access, with the use of mobile broadband being primarily driven by the availability of fixed-line infrastructure in a given location. In fact, approximately 41% of households have access to copper-based line telephony in the Dominican Republic, primarily in the large agglomerations, which means that wireless solutions are effectively the only way for the rural population to get access to broadband.

The broadband and fixed telephony markets are relatively concentrated, with Claro and Tricom together accounting for approximately 91% market share (67% and 24% respectively in the broadband market excluding mobile, and 65% and 22% respectively in the fixed telephony market) according to TeleGeography, as of December 31, 2013. Claro delivers broadband services through its xDSL and FTTx networks, while Tricom uses its xDSL and cable infrastructure. Both Claro and Tricom offer fixed-line telephony services using VoIP and PSTN. Other smaller players have a limited presence, with Wind Telecom taking an 8.3% market share in the broadband market through its wireless technology.

4. Other Territories

Belgium

We believe that Belgium is one of Europe's most attractive cable markets due to, among other things, a relatively high population density and cable penetration rate. The population density of Belgium reached 370 inhabitants per square kilometer in 2013, one of the highest in Europe, according to World Bank data, and is surpassed only by the Netherlands and some microstates such as Malta.

According to Ovum Research estimates, Belgium has an estimated 98% penetration rate in pay television (for 2014), significantly above the average Western European penetration rate of 68%. According to Ovum Research estimates, cable is expected to capture 72% of the pay television market, followed by IPTV (24% of the pay television market) and satellite (4% of the pay television market). Competition in the pay television market is currently limited due to a lack of overlap among cable operators. Telenet operates predominantly in Flanders, VOO in the French speaking part of Belgium and Numericable Group in Brussels (with Telenet and VOO also present in the capital). Belgacom, through its DSL-based network, is the only operator that offers national coverage, although we believe its IPTV technology currently provides an inferior product to cable players who have already upgraded their networks to EuroDocsis 3.0 throughout Belgium. Currently, Telenet, Belgacom and VOO have PAY-TV market shares of 46%, 22% and 24% respectively according to Ovum Research (as of December 31, 2013), while Numericable Group has a 2% market share nationally (and a 62% market share within its footprint), according to management estimates. The importance of cable operators in pay television may be affected going forward by changes to the regulatory regime allowing third-party access to cable networks, with wholesale offers required to be in place by autumn 2013, although such wholesale access would provide cable operators with stable, albeit somewhat lower, wholesale revenues.

Broadband internet access in Belgium is well established, with penetration rates of approximately 87% compared to 80% in Western Europe, according to Ovum Research (estimated for the year ending December 31, 2014). Cable is the leading broadband internet access platform in Belgium, with approximately 51% of the total broadband internet market, with DSL (predominantly offered by Belgacom) taking up 48%, according to Ovum Research estimates. FTTH is yet to be widely deployed in Belgium, as this technology is intensive as to both capital and time, requiring significant digging and

re-wiring. The largest operators are Belgacom (44%), Telenet (38%), according to Ovum Research and Numericable Group (1% nationally and 36% within its footprint, according to management estimate).

The Belgian mobile telephony market is valued at approximately €2.9 billion as of December 31, 2013, according to WICS. The Belgian mobile telephony market is advanced with an estimated active penetration rate of 122% according to Ovum Research. According to the BIPT, Belgacom had an estimated national market share of 41% in terms of active mobile subscribers followed by Mobistar (27%) and BASE (25%), as of December 31, 2013. In recent years, however, the number of MVNOs in the Belgian market has increased steadily, reaching approximately 2.1 million subscribers as of December 31, 2013, according to data gathered by the BIPT.

Triple-play products are offered by all of the main cable operators (Telenet, VOO and Numericable Group), as well as the incumbent, Belgacom. Quadruple play products are also becoming increasingly popular, with already successful MVNO strategies deployed by cable operators such as Telenet and Numericable Group.

2013 Market Shares by Subscribers

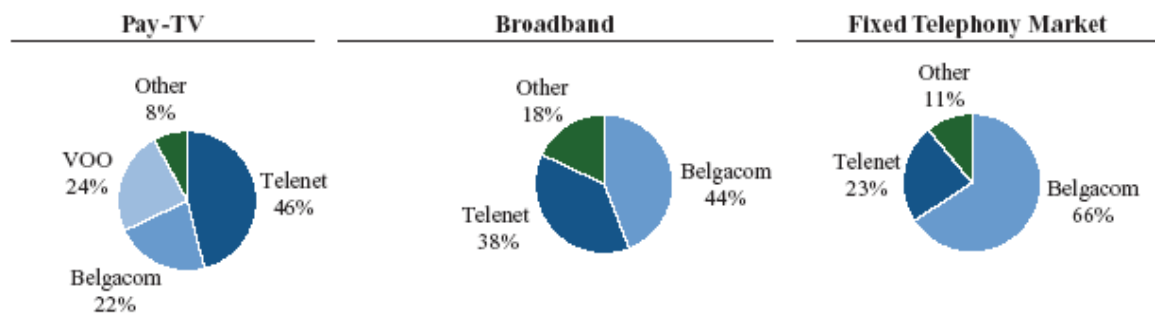

Source: Ovum Research, TeleGeography

Luxembourg

Luxembourg has a modest pay television penetration, which is slightly lower than the average Western European pay television penetration.

DSL is the leading broadband internet access platform in Luxembourg. POST, the incumbent, is the largest player, capturing 69% market share as at December 31, 2013 (Source: TeleGeography). The other providers are Belgacom, Eltrona and Numericable Group. There is increasing pressure from consumers for greater speed and lower prices, in particular as Luxembourg is the only country in the EU where the regulator does not set wholesale prices for DSL access, enabling POST to dictate the terms. Furthermore, the government announced plans in 2010 for FTTH to be implemented nationally and to provide at least 100 Mbs connectivity by 2015. In practice, POST is the only operator able to undertake these investments, leading the regulator to put in place measures guaranteeing access to fiber infrastructure for alternative operators. Despite these developments, FTTH deployment remains very limited in Luxembourg.

Due to POST's significant market power in the fixed-line market in Luxembourg, it is prohibited from bundling its television offering with its broadband internet and fixed-line telephony services. Only Eltrona and Numericable Group, together with some smaller operators, are able to offer triple-play bundles.

Similar to Belgium, Luxembourg enjoys a high and stable GDP (GDP CAGR of 2.0% from 2014 to 2017 according to IMF, as well as positive demographics (population CAGR of 2.0% from 2014 to 2017, according to IMF and a significant number of expatriates and foreign communities. Together with Luxembourg's topology and high population density, this makes it an attractive market in which to operate.

2013 Market Shares by Subscribers

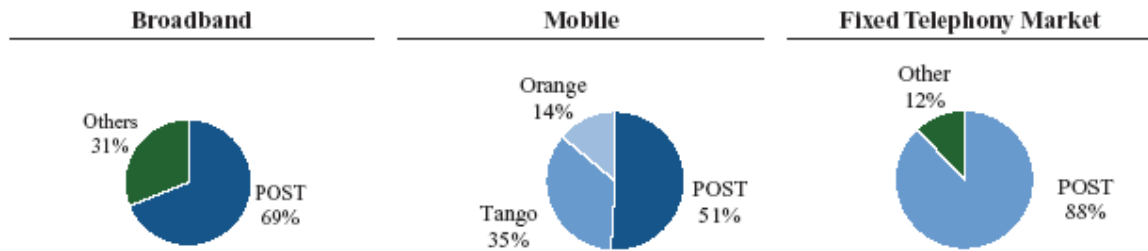

Source: TeleGeography, Ovum Research

French Overseas Territories

The French Overseas Territories markets are characterized by a young population (approximately 35% of the population is under the age of 20 in the French Overseas Territories, in comparison to 24% in mainland France, according to the United Nations database as of June 2013), price sensitivity and a strong demand for access technologies. Furthermore, infrastructure improvements are supported by subsidies from mainland. Importantly, mobile telephony licenses have so far been granted for free to the various operators and the upcoming grants of 4G licenses are expected to be no different.

Mobile telephony, the most important market in the French Overseas Territories telecom sector, is relatively mature with a current penetration rate of approximately 126%, according to management estimates. However, the young population and high price sensitivity results in lower mobile ARPUs and higher churn than for operators in continental Europe. The main players in the mobile telephony market include Orange, OMT, Digicel (only in Caribbean area) and SRR (only in Indian Ocean area).

Broadband internet access in the French Overseas Territories remains underpenetrated 55% according to The French Telecom Authority). DSL is by far the dominant technology, with limited announced plans for technology upgrades. The main players are Orange and OMT (and SRR to some extent in the Indian Ocean area), although there are a significant number of local DSL players, most of which offer unbundled local loop DSL services while renting Orange last mile on a wholesale basis. Presence of cable is so far limited but is growing rapidly in Martinique and Guadeloupe where Le Cable, the only cable operator with a network covering approximately half of the households, is rapidly upgrading its network to Docsis 3.0.

Demand for pay television is strong in the French Overseas Territories, with penetration rates at approximately 67%, according to ARCEP. The market is dominated by satellite TV, with Canal Plus and Parabole Réunion among the strongest players, and cable, with Le Cable. We believe growing demand for bandwidth and triple-play packages is likely to increase demand for alternative access technologies with the ability to provide interactive services such as video on demand.

As in mainland France and Western Europe, multiple play and convergence have increasingly become important. However, triple-play penetration lags behind that of more developed economies. Currently, we are the only operator that can currently offer quadruple play bundles and we expect this to become a way for us to differentiate our offering in Martinique and Guadeloupe, where other players are either only mobile or DSL operators (Digicel, MediaServ), while large players are considered dominant and are not allowed by local regulation to bundle products (Orange, SRR).

Market shares in French Overseas Territories

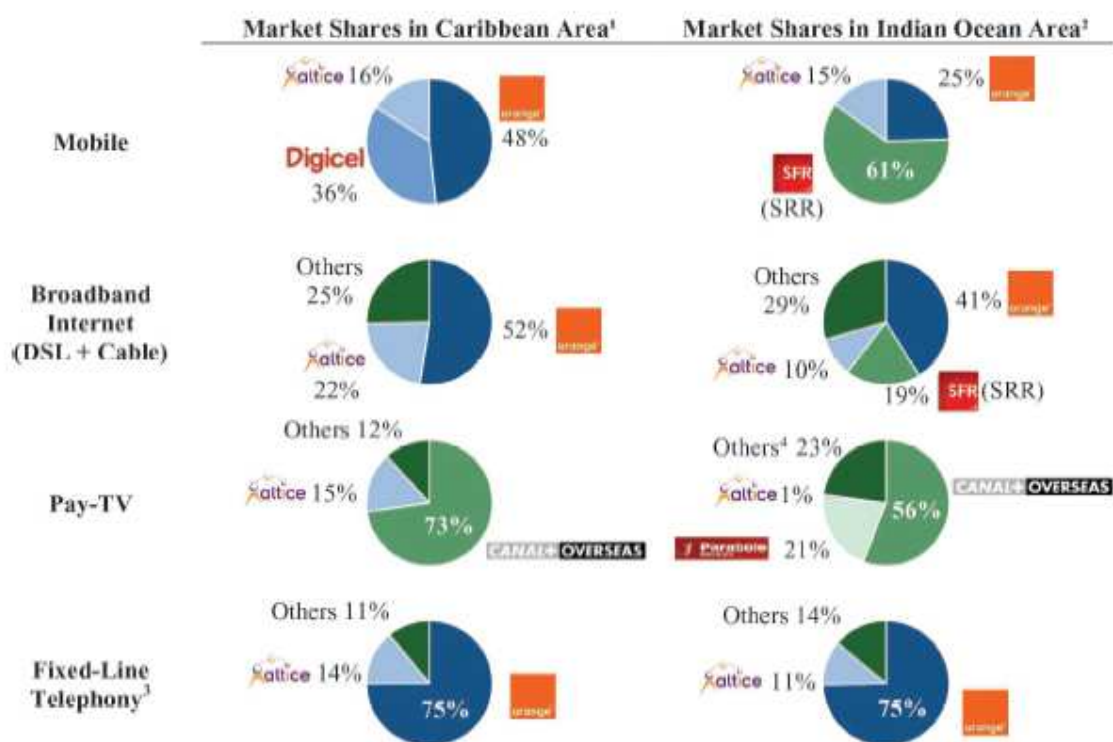

Source: Company Information.

Note: Since August 2013, the brand Numericable Group has been used for all the offerings except mobile

- (1) Based on a subscriber-based weighted average for Martinique, Guadeloupe and F. Guiana
- (2) Based on a subscriber-based weighted average for Reunion and Mayotte
- (3) Based on population-based weighted average market shares for Outremer Telecom only
- (4) Mainly Broadband Internet access providers

DESCRIPTION OF OUR BUSINESS

In this section, the terms “Group”, “we”, “us” and “our” refers to the Issuers and their subsidiaries (excluding PT Portugal). For an overview of our business, our competitive strengths and our strategy, see “General Description of our Business and the Offering—Altice Group—Overview”, “—Our Competitive Strengths” and “—Our Strategy”.

History

Since our inception, we have made significant investments in a number of cable and telecommunications businesses in Israel, Western Europe, the French Overseas Territories and the Dominican Republic. Set forth below is a list of the significant investments we have made in the businesses that currently constitute the Group:

- In 2008, we acquired Le Cable Martinique and Le Cable Guadeloupe, well-established cable providers that have been operating in the French Overseas Territories of Martinique and Guadeloupe, respectively, since 1994.
- In May 2010, we acquired MIRS Communications Ltd. (“MIRS”), an Israeli company providing iDEN-based mobile services. In July 2009, we began acquiring equity interests in HOT and its subsidiaries, the sole cable operator in Israel, and in March 2011 acquired a controlling interest. In November 2011, HOT acquired MIRS from us and renamed the company as HOT Mobile Ltd. In May 2012, we began marketing our UMTS-based 3G mobile services in Israel under our “HOT” brand. In December 2012, we completed the take-private transaction of HOT whereby we acquired substantially all of the equity interests in HOT that we did not previously own.
- In December 2009, we acquired substantially all of the equity interests in Green, a Swiss provider of B2B solutions. In 2010, we acquired substantially all of the equity interests in Green Datacenter and launched a greenfield project to build out a 11,000 square meter datacenter in the Zurich region. We began providing datacenter services in 2011. We have completed the construction of 3,600 square meters and a new build-out phase is currently in progress.
- In 2011, we acquired approximately 44.4% of the equity interests in Coditel Belgium and Coditel Luxembourg from an affiliated entity, and in November 2013 we acquired an additional 40% stake from one of the minority shareholders.
- In February 2012, we acquired a controlling interest in the Portuguese cable provider Cabovisão and, in February 2013, we completed the acquisition of substantially all of the equity interests in Cabovisão that we did not already own.
- In 2012, we purchased a 17% stake in Wananchi, a cable telecommunications provider with operations in Kenya, Tanzania and Uganda. On October 2, 2014, we invested an additional \$10.8 million into Wananchi through Altice Africa as part of a subordinated notes issuance by Wananchi. Altice Africa has pledged to fund up to \$40 million in three tranches, with the next tranche of \$20 million due within six months from the date of the payment of the first tranche (April 2, 2015). The Group obtained a new board seat as part of the funding, and the new notes are convertible. If fully converted, the new tranche, when fully funded, will give Altice Africa an approximate 21% shareholding in Wananchi.
- In July 2013, we expanded our presence in the French Overseas Territories by acquiring Outremer, a leading mobile services provider and xDSL provider of telecommunications services.
- In August 2013, we entered the Portuguese B2B market through the acquisition of the ONI Group.
- In October 2013, we acquired Ma Chaîne Sport and SportV (both producers of sports-related content).
- On January 15, 2014, we completed (through our subsidiary Altice Blue Two), the acquisition of the Mobius Group, a telecommunications operator in the Overseas Territory of La Reunion which provides internet access to professional clients under the “Mobius Technology” brand and double-play and triple-play services based on xDSL technology to residential customers under the “IZI” brand.
- On March 12, 2014, we completed (through our subsidiary Altice Caribbean), the acquisition of Tricom, a provider of telecommunications services operating in the Dominican Republic.
- On April 9, 2014, we acquired substantially all of the outstanding capital of ODO, a provider of telecommunications services operating in the Dominican Republic.

Products and Services

We offer a variety of services over our fixed and mobile infrastructure, including, but not limited to, pay television, broadband internet access, fixed-line telephony and mobile telephony to residential customers, and, to a lesser extent and depending on the geography, B2B telecom services to corporate customers. We provide our residential cable-based services primarily as part of double-play or triple-play packages and, in the French Overseas Territories, the Dominican Republic, and Belgium, quadruple-play packages which include mobile services in addition to our cable-based services. Available cable-based service offerings depend on the bandwidth capacity of our cable networks, which consist primarily of hybrid fiber-coaxial (“HFC”) cable infrastructure.

Our television service offerings include basic and premium programming, and, in most markets, incremental product and service offerings such as enhanced pay-per-view programming, including video-on-demand (“VoD”) and near-video-on-demand (“NVoD”), digital video recorders (“DVR”), high definition (“HD”) television (“HDTV”) services and, in some cases, exclusive content. We tailor both our basic channel line-up and our additional channel offerings to each country of operation according to culture, demographics, programming preferences and local regulation.

We offer broadband internet access services and fixed-line telephony in all of our broadband internet communications markets. We also own and operate mobile infrastructure in Israel, the Dominican Republic and the French Overseas Territories, and offer mobile services through MVNO arrangements in Belgium.

We offer some B2B telecom services in all our geographies. However, we service large corporate customers with a focused B2B offering only in Portugal, Switzerland, Belgium, the Dominican Republic and the French Overseas Territories. In Israel, our B2B services primarily consist of enhanced versions of our residential products which are adapted to the needs of small- and medium- sized businesses.

In 2014 we expanded our operations to the Dominican Republic through the acquisition of telecommunications providers ODO and Tricom. We intend to run our Dominican Republic operations under a single operating entity through the merger of ODO and Tricom. However, as of this date, we have not yet received the regulatory approval required for the merger. As such, ODO and Tricom continue to operate as distinct legal and commercial entities and this is reflected in the presentation of key operating measures and discussions of our businesses below.

Cable-based Services

Multiple-Play

We offer our customers bundled triple-play services comprising pay television, broadband internet access and fixed-line telephony services at what we believe are attractive prices. We also offer various double-play packages comprising a combination of two of these services. Furthermore, we continue to introduce quadruple-play services, which include a combination of cable-based triple-play and mobile packages, in a growing number of geographies, which currently consists of Belgium, the Dominican Republic and the French Overseas Territories.

We believe the demand for our multiple play packages is primarily driven by the inherent quality of the various products included in them, which we believe are among the best available in the markets in which we operate. Although we believe our products offer the best value for money when purchased as part of triple-play packages, we typically also offer most of these services on a standalone basis in most of our geographies.

Our digital television offering includes theme and premium content packages, HDTV channels, channels with start-over functionality, radio channels, VoD services and premium digital services such as DVR. Our cable networks enable us to offer interactive digital services to most of our customers. Our digital television offering includes content and channels purchased from a variety of local and foreign producers. We continue to focus on broadcasting high- quality content over all of our cable networks and seek to ensure we cater to local demand for content. In Israel, we co-develop leading original local content together with local producers and broadcast it on our proprietary suite of channels which, along with our distinctive brand, enables us to attract new subscribers to our cable-based services.

We offer broadband internet access services across our cable footprint and a majority of homes passed by our cable networks benefit from download speeds of at least 100 Mbps. Our networks benefit from substantial spectrum availability and, on a blended basis, the majority of the homes we pass are Docsis 3.0- enabled, including 100% in Israel. In the short-to medium term, we expect that the portions of our networks that are Docsis 3.0-enabled can offer download speeds of up to 360 Mbps with limited network and customer premises equipment upgrades given the existing technological capability of our networks. This technological capability can be realized with relatively low levels of capital expenditure and will enable us to better meet the needs of our residential and corporate customers who demand higher download speeds. As opposed to some of our competitors, we do not generally restrict maximum volume of data

or the speed at which our customers can access the internet. We also offer broadband internet access services based on xDSL technology in areas of the French Overseas Territories which are not passed by our HFC networks.

Our fixed-line telephony services are based on either PacketCable or VoIP technologies. We offer a wide range of telephony packages, and our triple-play offers tend to include flat-rate telephony packages with a significant number of minutes of use included in the price. We provide national and international connectivity to our customers either through our own interconnection capabilities or through our partners. We tend to phase out standalone telephony packages as our strategy is to offer fixed-line telephony as an add-on product in our triple-play packages rather than as a standalone product.

Our customers can achieve significant savings by purchasing pay television, broadband internet and fixed-line telephony as part of our bundles as opposed to separately from us or from our competitors. For example, our Israeli customers currently save approximately NIS 100 per month by subscribing to one of our top-tier triple-play packages, Triple iTop, currently priced at NIS 352, instead of separately purchasing the same products the price of which would amount to approximately NIS 452 in the aggregate.

While a focus on multiple-play offerings constitutes an integral part of our customer acquisition strategy, we also continue to offer stand-alone pay television, broadband internet access and fixed-line telephony services to our customers.

Pay Television

Western Europe

Portugal. In Portugal, we offer subscribers analog and both basic and premium digital television services under our “Cabovisão” brand. Our analog television service includes access to over 33 television channels. Subscribers to our basic digital television service have access to 95 digital television channels (including all of the analog television channels) and access to certain premium content and interactive services, such as VoD and catch-up TV. Our premium television service provides customers with access to 142 digital television channels, together with certain optional interactive features such as VoD, access to additional HD channels and HD premium content and certain other premium services. We provided cable television services to approximately 224,000 RGUs in Portugal as of December 31, 2013, and an estimated 214,000 RGUs as of September 30, 2014.

Belgium and Luxembourg. We offer subscribers analog and both basic and premium digital television services in the Brussels region of Belgium and Luxembourg under the “Numericable” brand. We believe we are the leading provider of pay television services within our footprint in Belgium. Subscribers to our basic digital television service can choose from a range of approximately 130 digital television channels in Brussels and approximately 110 channels in Luxembourg and are also able to access certain premium content and interactive services, such as VoD, HDTV and catch-up TV. Our premium television service provides customers with approximately 130-175 digital channels in Belgium and approximately 110-130 digital channels in Luxembourg, together with certain optional interactive features such as VoD, access to additional HD channels and HD premium content and certain other premium services, including exclusive rights to football matches from the Belgian league. To cater to culturally and linguistically diverse customers in the region, we include in our pay television packages various foreign language channels, including English, Arabic, Spanish, Italian and Turkish-speaking channels in Belgium, and English, Italian and Portuguese-speaking channels in Luxembourg. We provided cable television services to 129,000 RGUs in Belgium and Luxembourg as of December 31, 2013, and approximately 120,000 RGUs as of September 30, 2014.

Israel

We are the largest provider of pay television services in Israel based on number of subscribers. We offer primarily digital television services in Israel under the HOT brand. While we continue to offer analog television services to a decreasing number of customers (11,643, and 4,751, as of December 31, 2013, and September 30, 2014, respectively), we are in the process of phasing out this service which will free up bandwidth over our network enabling us to expand our digital services. We have developed targeted promotional offers to migrate our existing analog customers to digital television.

Our standard digital television package consists of 81 base television channels, two extra content packages, each of which adds five to 16 channels to the subscription depending on the content packages chosen by the customer, and 33 radio channels. Subscribers to our standard digital package can also purchase extra content packages giving them access to additional channels. We believe our standard offering includes more channels than the number of channels offered by our competitor in its standard pay television offering. Our standard television package contains a range of Israeli and international sports, current affairs, entertainment, music, film, documentaries, children, and adult channels as well as channels in Arabic and in Russian to address demand from the culturally diverse population of Israel. We include in our standard package the HOT suite of channels and others such as Eurosport, Fox News, MSNBC, BBC Entertainment,

MTV and Zee TV as well as all the “must carry” channels that we are required to carry on our network under existing regulation. We regularly update our standard digital television package to reflect changes in viewer interest. Our higher-end packages include all six of our extra content packages as standard and include 32 to 43 premium channels, depending on the subscription. We also offer up to 21 television channels in HD that have enhanced picture and sound quality compared to regular television channels. Under Israeli regulation, we are required to include in our portfolio of pay television offerings a low-priced basic package. This package currently provides subscribers with access to approximately 25 basic channels.

In addition to a high quality and diversified linear television offering, we offer our customers a variety of advanced services featuring interactivity, which are available even to customers not purchasing our broadband internet services. We also provide our digital customers with a start-over service for over 25 television channels, which is included in all of our digital television packages, enabling the viewer who misses the start of a program to go back to the beginning of the program while the broadcast is in progress. Our digital television offering also includes VoD. Our VoD library is extensive containing over 27,000 titles as of December 31, 2013, and 31,000 titles as of September 30, 2014. In addition, we offer access to additional content libraries not included in our standard VoD service on a pay-per-view or monthly subscription basis. Our VoD penetration rate was 57% of our pay television RGUs as of September 30, 2014, which we believe is the highest in Israel. We also offer digital customers our Personal Video Recorder (“PVR”) service, HOT Magic, for a monthly subscription fee by means of a set-top box that, in addition to receiving the regular digital broadcasts, enables digitally recording television programs to a hard disk in real-time. In 2011, we commenced offering digital customers the HOT Magic HD set-top box, which combines VoD functionality, HD technology and recording capabilities in a single set-top box. We rolled out LaBox, an advanced set-top box, in Israel under the commercial name of “FiberBox” at the beginning of March 2014.

As a result of an order issued by the Israeli Minister of Communications, since February 23, 2014, HOT, and local satellite company, “Yes”, have been required to offer a fixed-price, narrow-base package at a price not to exceed NIS 120 (approximately €25) per month. Our current offering pursuant to this order provides subscribers access to more than 20 basic channels.

We bolster our Israeli pay television service offering by significant investment in procurement and, uniquely to our Israeli business, co-development of content which we undertake in partnership with local production partners. We package such original and purchased content into a range of television channels that we own and broadcast under the HOT brand to our television customers. The HOT suite of channels includes HOT 3, where we broadcast our co-developed local content, HOT Family, seven movie channels, the Israeli Entertainment Channel, sports channels and more than 10 children’s channels, which we believe are highly popular in Israel and run shows with top television ratings such as Haborer, Asfur 2, Split 2 Wedding Season, TLV, Redband and Mehubarot 2. We also purchase rights to broadcast popular foreign channels over our network. Our total spend on television programming content during 2013 was NIS 598 million, and NIS 409 as of September 30, 2014 (€126.4 million, and €86.4 million equivalent, respectively, calculated based on the average exchange rate for September 30, 2014, of €0.2113 = NIS 1.00). We believe the quality of content we provide over our network generally and the HOT television channels in particular, has been a critical factor in attracting new customers, maintaining our existing customers and minimizing churn. Under existing regulations, we are subject to certain ownership restrictions that limit the number of television channels we are permitted to own. In addition, we are required by regulation to invest a minimum of 8% of our annual pay television revenues from subscriber fees in the production of original local content. We have been in compliance with these regulatory requirements in all material respects. For further details, see “*Regulatory—Television—Minimum Investment in Local Content Productions*”.

We had 875,000 pay television RGUs in Israel as of December 31, 2013, and approximately 862,000 as of September 30, 2014, representing approximately 77% and 79% of our Cable Customer Relationships in Israel, respectively.

French Overseas Territories

We currently offer analog and both basic and premium digital television services via our cable networks in Guadeloupe and Martinique under the “Numericable” brand. We provided cable television services to approximately 40,000 RGUs in Guadeloupe and Martinique as of December 31, 2013, and approximately 44,000 RGUs as of September 30, 2014. Our pay television offering includes up to 200 channels and radio stations including 40 HDTV channels. Our basic cable-based pay television package, Prima, priced at €49 per month, provides our subscribers with 106 channels and radio stations, including nine HD channels. Our premium cable-based pay television package, Premium+, offered for €69 per month, provides our subscribers with 201 channels and radio stations, including 35 HD channels.

We also offer, primarily outside of our cable footprint, our broadband internet subscribers IPTV services via an unbundled xDSL network across the French Overseas Territories. Our xDSL-based pay television offering is offered as part of a triple-play package, Prima ADSL, priced at €49 per month. This package provides our subscribers with 91 television channels and radio stations, broadband internet access with download speeds of up to 20 Mbps and unlimited fixed-line calls to landline and mobile numbers in the French Antilles region, French Guiana, mainland France and 100

international destinations. The premium package, priced at €59 per month, provides 130 television channels and radio stations.

Dominican Republic

We offer pay television services through our cable, xDSL and GPON networks in the Dominican Republic. Under the “Tricom” brand we offer over 300 channels through a choice of three different plans. Within those channels, 85 are available in HD, which represents the most extensive HD offering available in the Dominican Republic as of September 30, 2014.

Tricom is the second largest pay television operator in the Dominican Republic and the largest cable television operator, serving approximately 114,000 pay television subscribers, as of September 30, 2014. Tricom is present in both the B2B segment and residential consumer market as a pay television provider.

Broadband Internet Access and Fixed-Line Telephony

We provide broadband internet access and fixed-line telephony services across our cable (and in certain areas xDSL) footprint. We typically sell these services as components of our triple-play bundles which we believe are cheaper than the comparable services currently offered by our competitors.

Western Europe

Portugal. In Portugal, we offer customers various broadband internet packages under our “Cabovisão” brand with advertised download speeds ranging from 30 Mbps in our low-tier packages to 200 Mbps in our top-tier packages. Our cable network is approximately 99% upgraded to EuroDocsis 3.0. We also offer subscribers local, national and international long distance fixed-line telephony services and a variety of value-added telephony features using VoIP under the “Cabovisão” brand. We provided broadband internet access services to approximately 156,000 RGUs in Portugal as of December 31, 2013, and 152,000 RGUs as of September 30, 2014. We provided fixed-line telephony services to approximately 223,000 RGUs in Portugal as of December 31, 2013, and 213,000 RGUs as of September 30, 2014.

Belgium and Luxembourg. We are a leading provider of broadband internet access services in our footprint in Belgium and Luxembourg. We offer customers various broadband internet packages under the “Numericable” brand with advertised download speeds ranging from 50 Mbps in our low-tier packages to 200 Mbps in our top-tier packages. Our cable network is fully upgraded to EuroDocsis 3.0, allowing us to provide up to 200 Mbps download speeds to all upgraded households. Within our network areas in both Belgium and Luxembourg, we are currently the largest fixed-line telephony competitor to the incumbent national telecommunications operators, Belgacom and P&T Luxembourg. Our fixed-line telephony offering includes local, national and international long distance fixed-line telephony services, as well as value-added telephony features using voice over internet protocol (“VoIP”) under the “Numericable” brand. We use VoIP technology, which utilizes the open standards EuroDocsis 3.0 protocol in Brussels and EuroDocsis 2.0 (currently being upgraded to EuroDocsis 3.0) in Luxembourg, through which we are able to provide both internet and fixed-line telephony services. Customers in both Belgium and Luxembourg who subscribe to our broadband internet access or fixed-line telephony services as part of a triple-play package, in the mid-tier segment, benefit from lower prices than those currently offered by our main competitors. We provided broadband internet access services to approximately 57,000 RGUs in Belgium and Luxembourg (of which approximately 48,546 were in Belgium and approximately 8,806 were in Luxembourg) as of December 31, 2013, and 59,000 RGUs as of September 30, 2014 (of which approximately 50,362 were in Belgium and 8,654 were in Luxembourg). We provided fixed-line telephony services to approximately 53,000 RGUs in Belgium and Luxembourg (of which approximately 45,748 were in Belgium and 7,463 were in Luxembourg) as of December 31, 2013, and 52,000 as of September 30, 2014 (of which approximately 45,172 were in Belgium and 7,139 were in Luxembourg).

Israel

Internet service in Israel is structured in that it is segregated into two separate elements comprised of infrastructure or network access services and internet service provider (“ISP”) services. Infrastructure access service relates to access to the physical network infrastructure within Israel that is required to connect the customer’s device to the infrastructure access provider’s operator. This service is provided exclusively by us and Bezeq, the only telecommunication operators in Israel that own a national fixed-line network infrastructure. ISP services, which can be provided by any licensed provider, consist of providing access to the customer from the infrastructure provider’s operator, through its own operator, to the local and global internet network. ISPs generally also provide certain value-added services such as data protection services, security solutions, e-mail services and system administration services. A customer wishing to subscribe to internet services in Israel effectively needs to purchase each of these services and accordingly retains the choice with regards to providers for both services, i.e. it may choose to subscribe to the broadband internet infrastructure

access facilities of us or Bezeq while using a separate ISP provider. Under the terms of our ISP license, we are required to provide ISP services to any customer or other ISP license holder, including to customers of other broadband internet infrastructure access providers, on equal terms. For further details, see “*Regulatory—Internet Service Provider*”.

We offer broadband internet infrastructure access services to our residential customers under our “HOT” brand over our U.S. Docsis 3.0-enabled cable network which allows us to provide ultra-fast services with limited or no degradation in speed. Our U.S. Docsis 3.0-enabled cable network can theoretically support download speeds of up to 360 Mbps with new CPEs and certain limited modification to network equipment, which will allow us to easily upgrade our services in the future. Approximately 50% of our Israeli cable customers have customer services equipment in their homes which could support download speeds up to 270 Mbps. We currently provide our customers with options to purchase broadband internet infrastructure access services with advertised download speeds ranging from 30 Mbps up to 100 Mbps subject to certain time or data volume restrictions which are not currently enforced, although we reserve the right to restrict usage to prevent abuse, at competitive prices. Our customers can also choose from our triple-play and double-play packages which include broadband internet infrastructure access services along with our television and fixed-line telephony services. We had approximately 744,000 RGUs to our broadband internet infrastructure access service in Israel as of December 31, 2013, and 727,000 as of September 30, 2014, representing approximately 66% and 67% of our Cable Customer Relationships in Israel, respectively. As of December 31, 2013, we had approximately 37% market share of the broadband internet infrastructure access market in Israel, and 36% as of June 30, 2014, based on the total number of subscribers.

In February 2012, we started providing ISP services to our customers under the “HOTnet” brand. Unlike our competitors who generally offer ISP services at prices that increase depending on the access speeds desired by the subscriber, we offer our ISP services at NIS 20 (equivalent of €4.23, calculated on the basis of the September 30, 2014, exchange rate of €0.2113 = NIS 1.00) per month irrespective of access speeds, which we believe make our ISP offerings very attractive. We are currently permitted to provide ISP services on a stand alone basis and as part of a package with mobile services, and not as a part of our other multiple-play packages.

We provide fixed-line telephony services using PacketCable™ technology on our secure cable network by offering individual lines to our residential customers under our “HOT” brand. Our services include several ancillary value-added features for end users such as caller identity, call waiting and call waiting with caller identity, follow me (a call forwarding service enabling the user to be reached at any of several phone numbers), conference calling, last call return, blocking of calls with no caller identity, blocking of caller identity for outgoing calls and voicemail services. We provide our fixed-line telephony services on a stand-alone basis or as a component of our triple-play and double-play packages allowing customers to choose from a range of pricing options based on their expected usage. We offer a fixed-line telephony package of 1,000 free minutes to land lines and mobiles for NIS 101. We had 676,000 RGUs to our fixed-line telephony service in Israel as of December 31, 2013, and 681,000 RGUs as of September 30, 2014, representing approximately 59% and 63% of our Cable Customer Relationships in Israel, respectively. As of December 31, 2013, we had a 30% market share of the fixed-line telephony market in Israel (Source: TeleGeography).

Customers who subscribe to our broadband internet infrastructure access or fixed-line telephony services as part of a triple-play package benefit from lower prices than those currently offered by our main competitor.

We seek to maximize the use of our own cable network when routing calls in order to minimize interconnection costs and capitalize on our control over quality of service. We have reciprocal interconnection arrangements with all the domestic telephony operators, international long-distance operators and mobile operators in Israel pursuant to which we pay interconnection fees to such other service providers when our subscribers connect with another network and receive similar fees from providers when their users connect with our network through interconnection points. The Israeli Ministry of Communications has recently reviewed the interconnection fees paid to domestic fixed-line operators and set the interconnection rate at 0.99 agorot per minute irrespective of whether calls are made during peak or off-peak times.

Fixed-line telephony in Israel is segregated into two separate services comprised of domestic fixed-line telephony services and international long-distance services, each of which requires a separate license. We are currently licensed to provide both domestic and international long distance telephony services. The domestic license is valid until 2023 and the international license is valid until 2032, and both may be extended for additional ten-year periods subject to the approval of the Israeli Ministry of Communications.

French Overseas Territories

We provide broadband internet access services within our network area offering subscribers monthly rate plans. In Martinique and Guadeloupe, we offer such services over both our cable and xDSL networks. In French Guiana, Mayotte and La Réunion, we only provide broadband internet access services over our xDSL network. We offer advertised maximum download speeds of 30 Mbps and 20 Mbps over our cable and xDSL networks, respectively. Within our footprint, the download speeds of our broadband internet and xDSL internet access services are at least on par with those

offered by our competitors since all of our competitors rely exclusively on xDSL technologies. Further, our product portfolio also includes narrowband internet access (dial-up) services. We provided broadband internet services to approximately 73,000 subscribers (including 17,000 cable-based and 56,000 xDSL subscribers), as of December 31, 2013, and 95,000 subscribers (including 26,000 cable-based and 54,000 xDSL subscribers) as of September 30, 2014.

In Guadeloupe and Martinique, we offer subscribers local, national and international long-distance fixed-line telephony services on monthly rate plans and a variety of value-added telephony features over our cable network and, following the acquisition of Outremer, our unbundled xDSL network. We offer the same services in French Guiana, Mayotte and La Réunion solely over our unbundled xDSL network since we do not own a cable network in those territories. We provided fixed-line telephony services to approximately 95,000 RGUs in the French Overseas Territories (including 17,000 cable-based and 78,000 xDSL subscribers) as of December 31, 2013, and 115,000 RGUs (including 26,000 cable-based and 90,000 xDSL subscribers) as of September 30, 2014.

Dominican Republic

In the Dominican Republic we offer consumers broadband internet access and fixed-line telephony services through ODO and Tricom. Based on revenues for the year ended December 31, 2013, and for the nine months ended September 30, 2014, ODO was the Dominican Republic's second largest telecommunications provider, according to management estimates. According to management estimates, ODO is the third largest broadband wireless provider in the country, with approximately 37% market share as of September 30, 2014.

ODO offers a range of wireless broadband internet services through nomadic broadband internet (through dongles and WiFi devices) and Flybox, its customer premises equipment (CPE), as well as capacity-based plans and voice and data bundles on 3G and 4G-LTE. Approximately 107,000 residential customers take up broadband services through post-paid capacity-based plans as of September 30, 2014. Though ODO offers fixed broadband services in the business segment, these are relatively limited. ODO offers both pre-paid and post-paid packages to business customers, as well as digital services, including in-house platform agnostic applications development, fixed-voice and internet and other data offerings such as cloud services, mobile-to-mobile and premium non-voice services, post-paid.

In the B2B segment, ODO also offers packages including capacity-based offers and speed-based offers for SOHOs and SME/large companies, respectively. As of September 30, 2014, approximately 75,000 business customer lines subscribe to broadband internet services offered by ODO, of which approximately 42% are SMEs and large companies which can also benefit from ODO's fiber and WiMax technologies and other value-added services.

In addition to broadband internet services, ODO also provides selected SME and large business customers with fixed-voice services via SIP trunking (VoIP). ODO plans to provide SOHO customers with similar services in the future.

Tricom is the second largest broadband internet and fixed-line telephony provider with a national market share of approximately 27% (fixed broadband internet market) and 25%, respectively, according to management estimates, as of September 30, 2014.

As of September 30, 2014, Tricom had approximately 114,000 pay television subscribers, 138,000 broadband internet subscribers (including xDSL and cable), 281,000 fixed-line telephony subscribers (including DSL, VoIP, fiber and WLL) and 243,000 (including internet mobile) mobile subscribers. Tricom's activity in the B2B segment, which accounted for just under 19.8% of its revenue for the nine months ended September 30, 2014, mainly comprises fixed-line services, but also includes (to a lesser extent) broadband internet services.

Tricom provides internet access primarily through its xDSL network, although its cable broadband internet product is currently experiencing strong growth, and it has launched mobile broadband internet services leveraging on its recent 4G-LTE launch. Tricom offers both prepaid and post-paid fixed-line telephony plans, which include unlimited calls within its network. While Tricom continues to utilize its xDSL network to provide fixed-line telephony services, it also offers VoIP to homes passed by its cable network. Tricom also leverages its wireless network to transmit fixed-line voice services.

With respect to fixed services, Tricom benefits from an integrated platform which includes networks based on HFC, copper and fiber technologies while it prioritizes the modernization and expansion of its entirely digital cable network. As of December 31, 2013, Tricom had upgraded 77% of its cable network to bi-directional capability. Tricom has upgraded a further 10% of its cable network to bi-directional capability as of September 30, 2014, with a substantial majority of homes passed on 750 MHz or 1,000 MHz. Up to a maximum of 750 homes are served by each optical node in Tricom's network. Tricom's entire cable network is digital and capable of supporting HD and DVR services, and Tricom is continuing the expansion of its cable network into key cities that are still underpenetrated and where proprietary fiber optic is already present, meaning significant growth potential. To this end, it relies on an in-house team which designs approximately 80 kilometers of network each month, as well as third-party construction teams which implement in-house

design and build approximately 70 kilometers of network each month. Tricom has in-house capability to activate, and perform quality control procedures on, its network. In addition, Tricom has focused on maintaining its xDSL network to serve customers in areas not reached by its cable network.

We believe that we will benefit from cross-selling Tricom's high-speed broadband and pay television offerings to ODO's existing customers and ODO's mobile services to Tricom's customers in addition to offering new services that utilize both companies' product sets and networks. We believe the combination of Tricom and ODO will create a fixed mobile integrated player in the Dominican Republic. We believe that Tricom's and ODO's network infrastructures are complementary and we intend to progressively migrate the existing fixed-line DSL customer base in the Dominican Republic to Tricom's cable network where possible. We expect to generate savings by reducing maintenance costs and unbundled local loop ("ULL") and bitstream fees as well as realizing operational synergies. ODO's mobile business will also benefit from Tricom's network, which is expected to provide transmission capacity for ODO's base stations at lower cost than prevailing market rates for leased capacity. We also believe there is potential for savings by combining overlapping regional and national fixed backbones as well as optimizing mobile frequencies and networks, including utilizing Tricom's excess 4G spectrum which should allow for a cost efficient roll out of 4G services.

Customer Premises Equipment

We believe that advanced customer premises equipment is playing an increasingly crucial role in our cable-based business as it enhances the customer experience in various ways including by facilitating access to a wide range of user-friendly features and services, it offers a reliable channel for selling add-on and on-demand services, it allows for multi-screen television viewing and broadband internet usage by multiple parties and, when the set-top box and the modem are combined in one box, it allows cable operators to significantly reduce customer service expenses. We optimize the customer premises equipment we purchase by relying on our in-house design and development capability to build the user interface of our set-top boxes.

Accordingly, we have continued to roll out "LaBox", our most advanced set top box, in our Western European businesses ("One Box" in Portugal) and Israel. Since its introduction in the first half of 2013, we have already installed approximately 21,000 LaBoxes in Belgium and Luxembourg. We rolled out LaBox in Israel under the commercial name of "FiberBox" in March 2014. LaBox is an innovative integrated set-top box and cable router offered to customers subscribed to our premium multiple-play packages. We believe that LaBox is one of the most powerful and interactive set-top boxes currently available in the markets where it is offered. It can deliver very-high-speed internet, digital television services with a capacity up to 300 channels and fixed-line telephony with two telephone lines. LaBox has four tuners that allow subscribers to record two television programs simultaneously while watching a television program, as well as watching different channels in different parts of a house. Television can also be streamed to different kinds of screens (such as tablets and mobile devices). It has HD and 3D capability and also includes an 802.11n Wi-Fi router, and a removable 160 Gb PVR or optional 500 Gb PVR which allows it to hold over 125 hours of HD or approximately 190 hours of SD programming. Additional features include an optional Blu-Ray DVD player, access to social networking features such as Facebook and Twitter on television and a VoD price comparison engine and intelligent content search. Smart phones and tablets can act as "remote controls" for LaBox, allowing users to navigate the interface with their personal handheld device as well as to switch on and off the recording of television programs remotely through the application "TV Mobile". We expect that the introduction of LaBox will result in the increase of our ARPU by attracting new premium package customers and prompting existing customers to upgrade to our premium packages which offer LaBox as standard. We expect that LaBox will also promote the sales of our other premium services.

Mobile Services

Belgium

We began providing mobile services in Belgium in September 2012 under the "Numericable" brand through an MVNO agreement with Mobistar. The MVNO agreement with Mobistar has been terminated and replaced with a MVNO agreement with BASE. Our portfolio of mobile packages includes basic as well as premium offerings. Our basic package, Mobile Start, is attractively priced at €9.95 and includes 60 minutes of domestic calls, 50 text messages and 5 Mb of internet data. Customers may elect to purchase certain add-on packages to increase their allowance, including 100 text messages or 50 Mb for €5 per month, or 1000 text messages or 500 Mb of data for €10. Our higher-end packages include Mobile Extra which is currently priced at €26 and comes with an allowance for 5000 domestic texts, 150 minutes of national calls and 1 Gb of internet data, and Mobile Max, which currently costs €59.90 and includes unlimited domestic texts and calls and 2 Gb of internet data. When purchased along with any one of our triple-play packages, Mobile Max costs only €29.95 which we believe to be one of the best-value-for-money mobile packages currently offered on the Belgian mobile telephony market. As of September 30, 2014, we had approximately 3,400 mobile RGUs in Belgium, compared to some 3,000 RGUs as of September 30, 2013.

Israel

We provide mobile services in Israel to residential subscribers under the “HOT Mobile” brand on our UMTS-based 3G network, which we launched in May 2012, and mobile services targeted primarily at business subscribers under the “MIRS” brand on our iDEN network. Due to current regulations, we currently offer our mobile services only on a stand-alone basis and in a bundle with ISP services.

Our UMTS network is based on the HSPA+ technology and we believe that, when completed, it will be one of the most advanced nationwide networks in Israel. The roll-out of our 3G mobile services has enabled us to compete effectively in the mobile services market in Israel as we are able to provide up-to-date services to customers, including faster data transmission services (up to 42 Mbps) with a higher traffic capacity. Our customers also have the option of using a wider range of devices compatible with our network, including Android based and Apple branded handsets. Consequently, we will also be able to expand the range of value-added services we offer to include a wide variety of applications and content requiring higher data bandwidth and more advanced devices. Our UMTS network already extends to approximately 56% of the inhabited territory of Israel and covers approximately 71% of the Israeli population. Since we launched our mobile services in Israel in May 2012, we had relied on Pelephone’s network to provide in-country roaming services to our customers in areas not covered by our UMTS network. In December 2013, HOT Mobile and Pelephone amended the underlying agreement repealing the exclusivity clause which HOT Mobile was subject to. This amendment will allow HOT Mobile to exercise its rights under the Network Sharing Agreement with Partner, which has been approved by the Israeli Antitrust Authority (subject to certain minor conditions), but remains subject to final approval from the Israeli Ministry of Communications. The Network Sharing Agreement with Partner is valid until December 31, 2028, and provides for automatic renewals in five year increments after December 31, 2028. See “*Description of Our Business—Material Contracts—Mobile Network Sharing Agreement with Partner in Israel*”. In the interim period while we await final regulatory approval for the Network Sharing Agreement, we have also entered into a RoU Agreement with Partner which will expire in 2017. The RoU Agreement with Partner gives HOT Mobile a right of use over Partner’s mobile communication network for the purpose of providing nation-wide mobile coverage to our customers. We have also entered into a roaming contract with Vodafone pursuant to which Vodafone provides our 3G customers with international roaming capabilities. For further details, see “*Description of Our Business—Material Contracts—Agreement with Pelephone, Vodafone and Belgacom relating to mobile roaming services*”. Our Israeli cable-based business, which we run under the “HOT” brand, has allowed our mobile business to benefit from certain synergies including in respect of retail distribution and brand awareness.

We currently offer to private subscribers unlimited local calls, text messaging and internet access for what we believe to be an attractive monthly fixed price as well as unlimited international calls to selected destinations for an additional fee. We believe our monthly fixed prices are more competitive than those offered by our large incumbent competitors. These prices are subject to changes, predominantly driven by the competitive nature of the Israeli telecommunications market. We also offer users pay-as-you-use packages which charge customers on a per unit used basis. Our 3G services are targeted at post-paid subscribers who account for approximately 84% of the mobile market in Israel as of December 31, 2012, according to Informa Telecoms & Media. Since the launch of our UMTS based 3G mobile services in May 2012, we added approximately net 592,000 UMTS RGUs as of December 31, 2013 and approximately 746,000 UMTS RGUs as of September 30, 2014.

We also continue to provide mobile services using iDEN technology. As of December 31, 2013, we had approximately 218,000 RGUs, and as of September 30, 2014 approximately 186,000 RGUs, who subscribed to this service, most of whom are business customers. We expect the number of iDEN customers to continue to decline in future periods.

The Israeli Ministry of Communications has initiated a tender process for 4G-LTE frequencies comprising a total of eight frequency bands in the area of 1,800 MHz that will enable delivery of mobile services using LTE technology. On November 18, 2014, HOT Mobile submitted its offer for part of the spectrum in response to the tender. On January 12, 2015, the Israeli Ministry of Communications informed HOT Mobile that based on the results of the tender it would be awarded a frequency bandwidth of 2X5MHz in the 1.8 GHz spectrum, for a license fee of NIS 34.5 million (up to half of which may be paid by way of provision of a bank guarantee, which may be refunded, in whole or in part, upon HOT Mobile reaching certain market share milestones). The tender results will be brought before the Minister of Communications for approval. In the event that such approval is awarded, we expect to begin developing infrastructure within the arrangements we have entered into with Partner (subject to regulatory approvals) that would allow us to commercialize such services. Furthermore, we believe that upgrading our UMTS 3G network to 4G-LTE capability would be possible with limited incremental capital expenditure or investment in the newly formed limited partnership to be set up in Israel pursuant to the Network Sharing Agreement between HOT Mobile and Partner. The Ministry has allowed existing operators wishing to upgrade their systems immediately to temporarily use the frequency bandwidth of 5 MHz (X2) in the area of 1,800 MHz LTE technology (subject to certain conditions), and, as such, HOT Mobile is intending to launch such 4G-LTE services to customers in the coming months. For more detail, see “*Network—Israel*”.

French Overseas Territories

Prior to its acquisition by us, Outremer launched its mobile services in December 2004 and has increased its market share, in part, through its attractively priced propositions. We currently provide subscribers 2G and 3G mobile services relying on HSDPA 13 Mbps Single Carrier technology. We plan to apply for licenses to provide 4G services which are expected to be awarded via an application process that it is expected to begin in the first quarter of 2015 in the Caribbean area and by the beginning of the third quarter of 2015 in the Indian Ocean. We currently offer mobile subscribers a variety of monthly rate plans and pay-as-you-go plans. For example, our basic monthly mobile plan in Guadeloupe is priced at €14.99 (not including a handset) and has a 24-month lock-in period. This monthly plan includes 60 free minutes and pay-as-you-go internet data. Our high-end monthly plan in Guadeloupe is priced at €59.99 (including a handset), has a 24-month lock-in period and includes unlimited calls to other mobiles in Guadeloupe, 24/7 unlimited calls to landline and mobile numbers in the French Antilles, mainland France, French Guiana and 100 other international destinations, 24/7 unlimited texts to all mobile numbers in the French Antilles, mainland France and French Guiana as well as 2 Gb of internet data. As of December 31, 2013, we had approximately 375,000 total mobile subscribers in the French Overseas Territories, consisting of approximately 197,000 post-paid subscribers (including approximately 12,000 business mobile subscribers) and approximately 178,000 pre-paid subscribers. As of September 30, 2014, we had approximately 365,000 total mobile subscribers in the French Overseas Territories, consisting of approximately 205,000 post-paid subscribers (including approximately 13,000 business mobile subscribers) and approximately 160,000 pre-paid subscribers. Our mobile ARPU in the French Overseas Territories was €27.10 (including pre-paid subscribers) for the year ended December 31, 2013, and €28.40 for the nine months ended September 30, 2014.

Following the French Competition Authority's conditional approval of the purchase of SFR by Numericable Group, we have agreed to dispose of our mobile business in the Reunion Islands and Mayotte (including the 2G and 3G licenses and frequencies in La Réunion and Mayotte to the extent allowed by French Law).

Dominican Republic

ODO was launched in 2000 as the first GSM network in the Dominican Republic. It is now the second largest mobile operator in the residential segment, holding approximately 37% market share as of September 30, 2014, according to management estimates. ODO also has a significant presence in the B2B market, having captured approximately 26% of the market share as of September 30, 2014, in the mobile B2B segment measured by volume, according to management estimates. As a result of the strong "Orange" brand under which ODO has historically marketed its mobile voice and data services, its focus on customer experience and its efficient distribution channels, ODO captured the largest share of net mobile subscriber additions in the Dominican Republic market during the seven months ended July 31, 2014. During the nine months ended September 30, 2014, the market lost 316,000 lines, mainly due to the disconnection of prepaid users without identification on Indotel's request, which impacted all Dominican Republic operators.

ODO offers residential and business mobile subscribers a variety of pay-as-you-go plans and monthly-rate plans through its 2G and 3G networks. ODO had approximately 3.2 million total mobile subscribers of which approximately 2.5 million subscribe through pre-paid plans and 685,000 subscribe through post-paid plans as of September 30, 2014.

To service the Dominican Republic's significant tourist traffic, ODO also provides users of foreign mobile connections with international roaming services. ODO has entered into roaming agreements with various international telecom service providers for voice, internet, data, pre-paid, roaming hub and 3G services. Currently, ODO has agreements in place with leading international telecom companies from over 140 countries. ODO also attracts international incoming traffic through its long-distance business, providing international call termination to other local operators.

In the B2B segment, ODO offered services to 212,000 customer lines, with over 72% taking up plans aimed at SOHOs. ODO also offers plans to over 3,400 SMEs and large companies as of September 30, 2014. In the past, ODO's most successful offerings have been in the pre-paid consumer business. However, ODO is growing its post-paid and business offerings and continues to roll-out new products and services. ODO set up a dedicated business customer team in January 2011, and, since 2012, has expanded its offerings to include data packages for pre-paid, new post-paid tariffs including unlimited data and launched value-added services. ODO has also expanded its business services with features such as mobile-to-mobile (M2M) connection services, enhanced data security and telepresence.

In the mobile services sector, ODO benefits from what we believe to be efficient distribution channels through its homogeneous store network across the Dominican Republic, comprising more than 519 shops and 66,300 top-up points of sale. We believe ODO's strong footprint in areas with low mobile penetration makes it well-positioned to capture future growth. ODO also benefits from strong brand recognition from the "Orange" brand and a focus on customer service. As of September 30, 2014, ODO captured an approximate 47% share of mobile gross-adds for the previous nine months, based on management estimates, while operating only 18% of the approximately 2,900 points of sale in the Dominican Republic. In connection with the ODO Acquisition, we have entered into a Brand License Agreement providing for the right for ODO to continue to use the "Orange" brand for a period of three to five years after the ODO

Acquisition in respect of its current activities in the Dominican Republic. For further details, see “*Description of Our Business—Material Contracts—Agreements with Orange in the Dominican Republic*”.

Tricom also provides mobile telephony services through its wireless network. Tricom’s mobile offering includes 3G as well as 4G-LTE plans (depending on the handset) and mobile customers who subscribe to one of Tricom’s triple-play offers benefit from a free 4G-enabled smartphone under the current service plan.

Business-to-Business Services

Israel

We provide broadband internet access, pay television, fixed-line and mobile telephony services and a range of advanced telecommunications solutions to our business customers in Israel. Other than our iDEN-based mobile services which we market under the “MIRS” brand, we market all of our business-to-business services in Israel under the “HOT” brand. Our fixed-line telephony services include offering individual lines to businesses as well as PRI trunks (consisting of up to 30 voice lines per trunk) to our business customers. We also provide business numbering services allowing for toll-free calls from anywhere in Israel to 1-800 numbers and a split billing calling service to businesses (1-700). Our portfolio of advanced telecommunications services include data and video transmission and VPN services aimed at business customers and other telecommunication providers using synchronous digital hierarchy SDH technology or IP technology. Among the solutions we offer are network services for transferring data from point to point, transferring data between computers and between different communications networks, communications network connection to the internet and remote business access services. As our Israeli B2B business remains operationally integrated in our residential cable business and mobile business, we recognize Israeli B2B revenue within revenues from cable-based services and revenues from mobile services, as applicable.

In addition, we also license the pay television content formats that we create and own to other telecommunications providers around the world. For example, we have in the past sold our popular television series Split to providers in 72 countries.

Portugal

The acquisition of ONI in 2013, a leading B2B services provider in Portugal, has brought a strong B2B sales and marketing force and diverse customer base as well as attractive service offerings and distribution capabilities to our Group. As a result of the acquisition, we are one of the leading providers in the Portuguese B2B market since ONI is the sole telecoms operator exclusively focused in serving the Portuguese enterprise market. We believe that this acquisition will continue to allow us to expand our fixed-line product offering to a broader set of B2B customers at a lower cost as a result of our existing, extensive fully-owned last mile cable network throughout Portugal. Our B2B services offered in Portugal include broadband internet access, telephony, virtual private network, leased lines, datacenter services and other corporate fixed-line services to small and large businesses. Our customers include EDP (Electricity of Portugal), CEPSA, José de Mello Group, Roff, Transportes Sul do Tejo, the Portuguese Ministry of Agriculture, the Portuguese Ministry of Finance, Tourism of Portugal, EFACEC, Continental Hotels, INATEL, ANA Group, HOVIONE, and Auto Sueco Group.

Belgium and Luxembourg

In Belgium and Luxembourg, we offer a range of dark fiber, internet links and other fiber-based network services to telecommunications operators, financial institutions, public service customers and multinational companies. Our customers include Telenet, Verizon, Colt, Dexia and the European Central Bank in Luxembourg and the EU, NATO and the Brussels police in Belgium. We do not directly provide value-added services. Our business customers evaluate our offerings based on price, technology, security, reliability and customer service. We are the only operator with a fully secured backbone between Paris/Luxembourg and Brussels with excess capacity which we sell to our business customers who may require enhanced capacity or security.

Switzerland

We are one of the leading providers of information and communications technology services aimed at business customers in Switzerland. Our portfolio of service offerings includes broadband internet access, hosting, multimedia and data backup solutions. We conduct our B2B business in Switzerland under the “green.ch” brand, with the exception of our datacenter services which we also provide under the “Green Datacenter” brand.

Dominican Republic

We provide significant B2B telecommunication services in the Dominican Republic through both ODO and Tricom. ODO's presence in the B2B mobile market is significant, with approximately 26.4% of the market share as of September 30, 2014, according to management estimates.

In the B2B segment, as of September 30, 2014, ODO offers mobile services to over some 212,000 customer lines, with over 72% of business customers taking up plans aimed at SOHOs. ODO also offers plans to over 3,400 SMEs and large companies as of September 30, 2014. In the past, ODO's most successful offerings have been in the pre-paid consumer business market. However, ODO is growing its post-paid and business offerings and continues to roll out new products and services. ODO set up a dedicated business customer team in January 2011 and since 2012 has expanded its offerings to include data packages for pre-paid, new post-paid tariffs including unlimited data and launched value-added services. ODO has also expanded its business services with features such as mobile-to-mobile (M2M) connection services, enhanced data security and telepresence.

ODO also offers fixed broadband internet packages in the B2B segment, although this is relatively limited. As of September 30, 2014, approximately 75,000 business customer lines subscribe to broadband internet services offered by ODO (of which approximately 42% are SMEs and large companies). Such customers can also benefit from ODO's fiber and WiMax technologies and other value-added services.

ODO has been opportunistically deploying fiber to support the 4G-LTE roll-out and to be in a position to offer fixed services to targeted B2B clients. As an example, ODO began to offer B2B services in the Eastern area of the Dominican Republic in Bavaro/Punta Cana following the roll-out of fiber along the East route to Punta Cana, which was finalized at the end of 2013. ODO has also focused on IP multimedia (IMS) projects to support fixed-line services (GSM technology-based fixed offers, e.g. GSM deskphone) and new multimedia services, including fixed-line voice services for B2B customers, Rich Communication Services, voice-over-LTE and other collaborative multimedia. The B2B segment has been a key focus area for ODO since it first launched dedicated services to business customers in January 2011 and ODO is currently in the process of moving from a mobile-centric offering to a full-service provider with various enhancements being made to its network.

Tricom also engages in significant activity in the B2B segment in which it mainly offers fixed-line services, but is also present in the broadband, data, pay television and wireless segments. B2B activity accounted for 22% of its revenue for the nine months ended September 30, 2014, with Tricom serving a large portfolio of over 10,300 corporate including banks, international telecom operators and government offices, as of the same date. Additionally, Tricom has a well-diversified customer portfolio with its top ten customers accounting for less than 17% of its B2B revenue in the nine months up to September 30, 2014.

Content Subsidiaries

In October 2013, we acquired the French and Luxembourg operators of sports-themed television channels Ma Chaîne Sport and SportV. Ma Chaîne Sport produces and assembles a diverse range of content including live broadcasts of sports events and other programs relating to football, tennis, handball, boxing and other sports as well as general health and well being. It broadcasts such content via four specialized French channels, Ma Chaîne Sport, Ma Chaîne Tennis, Ma Chaîne Extreme and Ma Chaîne Bien Etre. SportV produces and assembles pay television content focused primarily on extreme and combat sports for distribution via its French television channel, Kombat Sport. We offer the channels distributed by Ma Chaîne Sport and SportV as part of our pay television packages in several of our geographies. In addition, Ma Chaîne Sport and SportV also distribute their television channels to third party service providers including Numericable France, Zeop, Canal Plus, Orange, Startime, Maroc Telecom, Naxoo and Netdream.

Marketing and Sales

While historically the marketing and sales functions of our Group were carried out entirely by locally managed teams, we are currently in the process of establishing a monitoring and benchmarking system at Group level which will allow us to better track monthly marketing and sales performance metrics on a Group-wide basis. We expect that this initiative will allow us to tailor our marketing and sales strategy in better accordance with the trends in the markets in which we compete.

Our businesses' marketing departments are responsible for strategic brand positioning and developing and monitoring our advertising campaigns. Working in conjunction with our sales and customer care divisions, our marketing divisions use a combination of individual and segmented promotions and general brand marketing to attract and retain subscribers. We target our marketing efforts at residential customers in single-dwelling units and multiple-dwelling units such as apartment buildings. We also market our B2B services to institutional customers and businesses such as large corporates, governmental and administrative agencies, small- and medium-sized businesses, nursing homes, hospitals and hotels. Our

primary marketing channels are media advertising including commercial television, telemarketing, e-marketing, door-to-door marketing, billboards, newspaper advertising and targeted mail solicitation. We continuously evaluate our marketing channels to allocate our resources most efficiently. Marketing is a key focus of our businesses, with €87.9 million (excluding ODO) spent on sales and marketing efforts by the Group in the year ended December 31, 2013, and €66.5 million (excluding ODO) spent in the nine months ended September 30, 2014. Out of these totals, our businesses in Israel, Belgium & Luxembourg, Portugal and the French Overseas Territories accounted for €49.9 million, €3.4 million, €10.0 million and €20.0 million, respectively, in 2013, and €38.9 million, €1.2 million, €7.6 million and €12.0 million, respectively, in the nine months ended September 30, 2014.

In Israel, we market and sell our cable-based services under the “HOT” brand and in 2012 we began to also market our 3G mobile services aimed at residential customers under the “HOT Mobile” brand which allows us to leverage the recognition associated with the “HOT” brand. We continue to market our iDEN-based mobile services to business customers under the “MIRS” brand. As part of our commercial television advertising strategy, we contract with popular Israeli celebrities, including actors associated with local content that we broadcast, to market our services and increase customer awareness of the “HOT” brand.

In Portugal, we market and sell our cable-based services under our “Cabovisão” brand. Our marketing department at Cabovisão is divided into two groups: a communication team responsible for designing our advertising and a product management team responsible for developing our product offerings and overall marketing strategy. Our marketing efforts leverage our strong local presence and the reliability of our customer service functions, and are focused on a simplified new offer for easier comparison with our peers’ products. In Portugal, we market and sell our B2B services under our “ONI” brand. Our marketing is based on the attributes of our brand, a differentiated promotion effort and product offering by market segment. We offer a global and integrated portfolio of tailor-made B2B services to customers operating in multiple locations with often complex business requirements as well as communications services packages to SME/SMBs. In addition to our website, we promote our services to the corporate and public sectors through one-to-one marketing, business and technological events and publications and selective corporate publications. To complement this, we develop tactical regional approaches to market our offerings to SME/SMBs. Our go-to-market approach is based on direct and indirect channels and our sales team is organized by market segment.

In Luxembourg and Belgium, we market and sell our cable-based services under the “Coditel” brand and the “Numericable” brand, the latter of which we have licensed from Numericable France. Our primary marketing channels include internet and radio advertisements and billboard advertisements.

We began to market our cable-based and xDSL-based services in the French Overseas Territories of Martinique and Guadeloupe under the “Numericable” brand name in September 2013. We continue to use the “ONLY” brand to market our mobile services across the French Overseas Territories and our xDSL- based services in French Guiana, La Réunion and Mayotte. In the French Overseas Territories, we use comparative adverts and promotions as part of our mass media advertising campaign to promote our low prices, proximity and quality.

In the Dominican Republic we market and sell all our ODO telecommunications services under the “Orange” brand. In connection with our acquisition of ODO, we have entered into a Brand License Agreement providing for the right for ODO to continue to use the “Orange” brand for its current Dominican Republic activities for a period of three to five years after closing of the ODO Acquisition. As a result, ODO benefits from strong brand recognition in the Dominican Republic. In the Dominican Republic we also offer pay television services through under the “Tricom” brand.

Our marketing strategy is based on increasing the penetration of multiple-play services within our subscriber base, increasing distribution of television-based value-added services and ensuring a high level of customer satisfaction in order to maintain a low churn rate. We highlight our multiple-play offerings in our marketing efforts and focus on transitioning our analog and digital video-only customers to multiple-play packages. We believe that customers who subscribe for more than one service from us are significantly more loyal to us.

We use a broad range of distribution channels to sell our products and services throughout our operations, including retail outlets owned and run by the Group, retail outlets owned and run by third parties, dedicated sales booths, counters and other types of shops, door-to-door sales agents who are either employed by us or are paid a commission based on sales closed, inbound and outbound telesales and, in certain countries, our websites.

Our sales distribution channels in Israel include 38 dedicated sales booths owned by the Group and operated by external dealers (the “HOT Booths”), other dealer outlets, telemarketing, and a door-to-door sales team. We have an in-house sales department for cable services, which is responsible for our sales, and we also hire external sales agents to facilitate our sales who earn a commission based on number of sales closed. Our largest distribution channel is telemarketing, while door-to-door sales and dealer sales also account for a significant portion of our sales. In Israel, we target our marketing efforts for our 3G mobile services primarily at individual customers and our iDEN mobile services primarily at institutional and business customers. We use a broad range of distribution channels to sell our mobile services, with the

majority of our sales through the HOT Booths and approximately 15 sales and service centers, and a smaller portion through other dealer outlets such as branches of the Israel Postal Corporation and Menta stores Electric Warehouse, our HOT Mobile website, telesales and door-to-door sales. In the ultra orthodox sector, we market our mobile services through an external distributor. Additionally, we focus on recruiting individual customers through our business customers by offering attractive packages and plans to their employees.

In the French Overseas Territories, we have attractive distribution capabilities with 72 points of sale for approximately 2 million inhabitants across the region. Our recent acquisition of Outremer has allowed us to gain access to this high-density distribution network with excellent cross-selling and up-selling opportunities. While most of our competitors externalize distribution, we believe our distribution network is a key competitive advantage as it enables us to better control sales and costs and to better service our customers as our service offerings become increasingly more complex, while also facilitating cross-selling. We have progressively increased the range of products we sell in our retail outlets starting from mobile, fixed-line telephony and xDSL-based services to, more recently, mobile accessories, handset insurance and new subscription-based services payment services. We have also integrated our cable and mobile distribution networks following our acquisition of Outremer which allows us to sell cable-based services in our shops in Martinique and Guadeloupe.

We have a distribution network of 29 retailers in Belgium and eight retailers in Luxembourg. We make both inbound and outbound telesales through our customer call centers in Casablanca, Morocco, and Differdange, Luxembourg. We encourage customers to purchase our products and services through our website, which we believe provides customers a clear understanding of our product prices and features, and results in lower subscriber acquisition costs.

In Portugal, we have two different sales teams with one focused on residential cable customers and the other one targeting B2B customers. For the year ended December 31, 2013, and the nine months ended September 30, 2014, door-to-door sales accounted for the majority of our sales of residential cable television services, followed by sales through our 20 retail stores, followed closely by our inbound/outbound telesales. We have opened an online store and the initial results are encouraging. We incentivize our sales force through progressive commission rates based on number of sales closed while at the same time being able to reduce our fixed costs in pursuit of increased productivity. We are adopting measures to shift our distribution channels from door-to-door channels to call centers and stores (physical and online). We believe that this will help us to better serve the needs of our target customers. Our B2B sales force consists of a dedicated team of 53 (including 13 presales agents) covering our entire footprint and focuses on small offices, home offices, small and medium enterprises, large corporates and public entities. Our B2B sales team is supported by a call center function.

In the Dominican Republic, ODO benefits from what we believe to be efficient distribution channels through its homogeneous store network across the Dominican Republic, comprising more than 519 shops and 66,300 top-up points of sale. We believe ODO's strong footprint in areas with low mobile penetration makes it well-positioned to capture future growth. For example, ODO captured approximately 47% share of mobile gross-adds for the nine months ended September 30, 2014, based on management estimates, while only operating 18% of the approximate 2,900 points of sale in the Dominican Republic.

Likewise in the Dominican Republic, Tricom has developed a multi-channel distribution approach to provide its range of services to residential and business clients. It owns a network of 144 stores throughout the Dominican Republic which plays a critical part in its distribution strategy relating to its re-launched wireless business services. Approximately 127 dealer stores, with which Tricom has partnered up, account for the vast majority of its wireless services sales. The two key distribution channels for fixed services are (i) telemarketing where a dedicated team reaches out to clients to offer Tricom's services and products, and (ii) door-to-door sales where the sales force of approximately 115 physically visit clients at their homes and offices. Although still a minor channel, online sales are expected to grow as traffic on Tricom's website has been experiencing strong growth.

Customer Contracts and Billing

We typically enter into standard-form contracts with our residential customers. We review the standard rates for our services on an on-going basis. In certain of our geographies, in addition to the monthly fees we charge, customers generally pay an installation fee upon connecting or re-connecting to our cable network. The terms and conditions of our contracts, including duration, termination rights and the ability to increase prices during the life of the contract, differ across our operations primarily due to the different regulatory regimes our business is subject to in each of the jurisdictions in which we operate.

In Israel, we offer our residential cable customers commitment-free contracts meaning that they can terminate the contract at any time without paying an exit fee. Our residential customers are charged a monthly fee based on our standard rates at the time of subscription, which includes a monthly rental fee for end-user equipment such as set-top boxes. We have recently become subject to new regulations which require that the monthly fee for our pay television can

only be collected at the end of the month for the services delivered during the preceding month. Previously we offered contracts with a duration of 12 or 18 months. Although in Israel we are generally locked into the prices we offer for the duration of a contract, we are not necessarily committed to maintain the prices at which we currently offer our products indefinitely. For example, we are permitted to increase prices based on an increase of the CPI index used to measure inflation and, in certain offers, subject to certain other terms. However, the price of our analog television services is subject to a maximum tariff, which is determined by the Israeli Broadcasting Council from time to time. Analog television accounted for 11,643 pay television RGUs in Israel as of December 31, 2013, and 4,751 as of September 30, 2014. The prices of our other cable-based services are subject to general oversight of the regulatory authorities, including notification requirements for price changes, but are not subject to a maximum tariff. Our contracts with business customers are generally not commitment-free, provided the amount exceeds NIS 5,000 per month, and pricing is based on our standard rates for the services subscribed to or in certain cases on individually negotiated rates.

We also offer our HOT Mobile residential mobile customers commitment-free contracts meaning that they can terminate the contract without paying an exit fee at any time. We were among the first mobile operators in Israel to unbundle our services from the purchase of handsets by offering customers our 3G services on handsets of their choice which they need not have purchased from us. Our mobile customers are generally charged a monthly fee based on our standard rates at the time of subscription and a one-time fee relating to SIM cards, and if purchased from us, the sale of handsets which we do not subsidize.

In Portugal, for our residential cable customer contracts, we offer standard contracts with a duration generally of 24 months and in certain cases 12 months. New customers are typically locked in for a 24-month period. Monthly fees include our rates as of the date of subscription plus a rental fee for end-user equipment. While we typically provide customers with modems free of charge, we offer set-top boxes either free of charge or subject to a discount, depending on the offer. In line with market practices in Portugal, we usually do not charge our customers any connection fees. We are permitted to increase prices without any limitation imposed by the regulatory authority; however, we are required to provide our customers with one month's prior notice. Contracts with business customers are individually negotiated, and the fees charged are typically agreed upfront and generally remain fixed for the entire duration of the contract. Business customer retention is high compared to the retention of residential customers as switching service providers in the short term can be difficult and costly especially for large corporate customers. Long-term business customer contracts have terms ranging between six to 60 months (with most contracts being for 24 or 36 months).

In Belgium and Luxembourg, we offer our residential cable contracts with a maximum duration of six months due to regulation. We are permitted to increase prices during the term of our customer contracts subject to an obligation on our part to afford customers the right to terminate their subscriptions should we decide to raise prices (and subject to the approval of such price increase by the Minister of Economy in Belgium). For regulatory reasons, we do not charge our customers early exit fees if they decide to terminate their contracts with us prior to expiration.

In the French Overseas Territories, we typically offer residential cable and xDSL customers contracts with a duration of 12 months, while our mobile customer contracts typically have a duration for up to 24 months. We are permitted to increase prices during the term of our customer contracts subject to an obligation on our part to afford customers the right to terminate their subscriptions should we decide to raise prices. We charge our customers early exit fees if they decide to terminate their contracts with us prior to expiration.

Our billing system for cable-based services in Israel has been developed by Convergys Solutions Limited ("Convergys") and we receive certain consulting, support and maintenance services from Convergys. Our billing system for our 3G mobile operations in Israel is an integrated billing and customer contact management system developed by Comverse Ltd. ("Comverse"). Our billing system for our iDEN mobile operations has been developed by Motorola Israel Ltd. Our billing system, ProCable, used in our cable operations in Portugal, Belgium and Luxembourg has been developed by InfoCABLYS, a Canadian provider of customer care and billing systems. In our French B2B operations, we rely on Arbor's billing software. In our Portuguese B2B operations, we use Stratus RedKnee's billing system as well as our own in-house billing system to a smaller extent. Our business in the French Overseas Territories continues to use a billing system which it has developed in-house.

In the Dominican Republic through our ODO operations, we bill our post-paid mobile subscribers directly. SIM cards, mobile phones and other devices can either be purchased directly from us or from one of our indirect distributors who, in turn, purchase them from us. We send monthly bills to our post-paid mobile customers, payable within seven to 25 days, and we monitor customer collections and payments. Overdue receivables in excess of 90 days are transferred to a third-party factoring agency. Pre-paid mobile customers purchase SIM cards, mobile phones and other devices directly from us or from retailers and dealers who, in turn, purchase them from us. We bill these retailers, dealers and distributors shortly after we deliver these products. These customers then have the ability to top-up their accounts through a number of payment channels, either directly with us (through the internet or in one of our stores), via Unstructured Supplementary Service Data ("USSD") or through any of our indirect distribution partners.

In all the jurisdictions in which we operate, we generally offer our customers the choice between electronic and paper statements and the ability to pay by bank order or credit card. We monitor payments and the debt collection process internally. We perform credit evaluation of our residential and business subscribers and undertake a wide range of bad debt management activities to control our bad debt levels, including direct collections executed by our employees, direct collections executed in co-operation with third party collection agencies and pursuing legal remedies in certain cases.

Customer Service

We aim to increase our customer satisfaction and decrease churn with high product quality and dedicated service. The customer service function for our cable-based and mobile services is carried out by approximately five call centers located in Yakum, Beer Shera, Haifa, Nazareth and Migdal Ha'omek, Israel (servicing our Israeli customers), a call center located in Casablanca, Morocco (servicing our French-speaking customers in Belgium), a call center located in Brussels (servicing our Dutch-speaking customers in Belgium), a call center in Differdange, Luxembourg (servicing our customers in Luxembourg), two call centers in Palmela, Portugal and Caldas de Rainha, Portugal (servicing our residential customers in Portugal), one call center in Lisbon, Portugal (servicing our business customers in Portugal) and a call center in Mauritius (servicing our customers in the French Overseas Territories). We also provide our customers with access to technical support help desks which operate at substantially all times.

Visits to customers' premises are performed by a mix of in-house and outsourced technicians. We aim to increase the extent to which this function is outsourced as we believe it optimizes our operational risks and costs.

In geographies where we offer B2B services, our institutional and business subscribers are served by dedicated business service and technical centers.

We have launched and partially implemented initiatives aimed at improving our customers' experience. These initiatives include enhanced Customer Relationship Management ("CRM") systems, which allow us to better manage new subscribers, identify customers at risk of churning, handle complex customer issues, offer special retention offers to potential churners and repayment plans to insolvent customers.

In Israel, we believe we have substantially improved customer care as a result of the introduction of new processes resulting in shorter waiting times in call centers, new ways of servicing customers such as via Facebook and live chat functions, the development of self-service applications, increased automation, a closer relationship with our subscribers through an increased number of interactions and the 24/7 availability of our technical support representatives. We believe a large proportion of our customers are loyal to our brands thereby reducing churn. As of September 30, 2014, approximately 63%, 52% and 41% of our Israeli pay television, broadband internet infrastructure access and fixed-line telephony customers respectively have been our customers for over four years, and approximately 57%, 55% and 57% of our Portuguese residential pay television, broadband internet access and fixed-line telephony customers respectively have been our customers for over four years.

With respect to the majority of our operations, we outsource our customer service functions to third-party providers. Such providers use operating procedures, tools and training that are provided by the Group. However, in some of our geographies, a team of in-house specialists handles the most complex customer care issues. We see limited potential for further improvements in the efficiency of our customer care operations, as we have focused on optimizing these for several years.

We believe that the high-density distribution network we have in the French Overseas Territories as a result of the recent acquisition of Outremer enables us to provide better service to our customers as they can easily reach our stores. This will be particularly useful as our product and service offerings become increasingly broad and complex. As part of Outremer's integration into our Group, we are currently in the process of rolling out our customer service practices, including customer service functions relating to quadruple-play services, across our retail network.

Network

Israel

We provide our pay television, broadband internet infrastructure access and fixed-line telephony services through our extensive fully-owned cable network which we believe is one of the most technologically advanced networks in the EMEA region. Our cable network passes most of Israel's 2.2 million households. The fiber-rich characteristic of our network generally gives it inherent capacity, speed and quality advantages as compared to copper-based xDSL networks. In particular, a fiber and coaxial cable offers a larger bandwidth than copper cable and, unlike the latter, it is not significantly affected by attenuation (i.e., a reduction in the strength of the signal) or distortion (i.e., a reduction in quality of the signal) when the signal is carried over a long distance. Our cable network allows the provision of fiber optic transmission services using DWDM technology, SDH technology or IP technology. In addition, our cable network

backbone includes two national and regional strategically interconnected head-ends that enable transmission of signals over our cable network. We are in the final migration process of switching telephony customers from 4 Nortel CS2K telephony switches to the new telephony environment based on Genband (Class 4) and Broadsoft (Class 5) switches with advanced Session Initiation Protocol (“SIP”) switch which is used to create and control communication sessions over an IP network. Our network supports minimum capacity per household of 862MHz in approximately 45% of our homes passed, 750 MHz in approximately 40% of our homes passed, and 600 MHz in approximately 15% of our homes passed, respectively.

Our cable network enables us to deliver broadband internet infrastructure access, fixed-line telephony and other interactive services, such as VoD, to our customers throughout our cable network in addition to regular digital and analog television services. Our entire cable network is also U.S. Docsis 3.0-enabled allowing us to provide ultra-fast broadband internet infrastructure access services at a download speed of up to 100 Mbps with limited or no degradation in speed throughout our network, which we believe is the fastest in Israel on a large scale and can support theoretical download speeds of up to 300 Mbps with certain limited modification to network equipment, which will allow us to easily upgrade our network to increase download speeds in the future. In 2011 and 2012, we also began selectively deploying FTTx network upgrades to certain households, which involved replacing existing copper wires used for local loop connectivity with optical fiber to reach the end user’s building or last amplifier. We plan to continue the selective deployment of FTTx at our discretion which will enable an expansion in the traffic capacity over our cable network and improve our VoD services, increase the number of television channels we are able to offer and increase the speed of our internet services.

Our cable network is fully owned by HOT Telecom. Part of our cable network runs through ducts and poles owned by Bezeq. We are party to certain continuing arrangements with Bezeq relating to the installation and maintenance of such parts of our cable network. We incurred total costs of NIS 46 million, NIS 48 million and NIS 47 million in 2011, 2012 and 2013, respectively, for services provided by Bezeq under these arrangements. For further details, see “*Description of Our Business—Agreements with Bezeq relating to installation and maintenance of portions of our cable network—Material Contracts*”.

HOT Mobile historically provided mobile services using an iDEN-based mobile network infrastructure, which, as of December 31, 2013, comprised of approximately 635 network sites, and as of September 30, 2014, consisted of approximately 630 network sites, distributed throughout Israel providing nationwide coverage. In relation to the roll-out of our UMTS-based 3G mobile services, we are in the process of building and expanding a UMTS network based on modern HSPA+ technology. We have committed to the State of Israel to achieve the following periodic coverage milestones for our UMTS network based on total Israeli population: by September 2015, coverage of 40% of the settled area of Israel and where at least 40% of the Israeli population is residing; by September 2016, coverage of 55% of the settled area of Israel and where at least 55% of the Israeli population is residing; by September 2017, coverage of 75% of the settled area of Israel and where at least 75% of the Israeli population is residing; and, by September 2018, coverage of 90% of the settled area of Israel and where at least 90% of the Israeli population is residing and coverage of 90% of the roads in Israel. We have expanded our UMTS network coverage through a combination of modifying our existing mobile network sites by installing UMTS equipment enabling the use of the new frequencies and building new UMTS enabled sites. Our UMTS network already extends to approximately 56% of the inhabited territory of Israel and covers approximately 71% of the Israeli population. We have deployed approximately 1,000 sites as of September 30, 2014.

We believe that the Network Sharing Agreement between HOT Mobile and Partner will reduce the need for new sites, resulting in the slowing down of the roll-out of the new sites. Previously, we relied on an agreement with Pelephone, a subsidiary of Bezeq, pursuant to which we used Pelephone’s in-country roaming services to service our customers while we built out our UMTS network. In November 2013 we entered into the Network Sharing Agreement with Partner pursuant to which HOT Mobile and Partner will own equal shares of a newly formed limited partnership, which shall hold, develop and operate an advanced shared mobile network for both companies. Furthermore, in December 2013, HOT Mobile and Pelephone amended their underlying agreement repealing the exclusivity clause which HOT Mobile was subject to. This amendment will allow HOT Mobile to exercise its rights under Network Sharing Agreement. The Network Sharing Agreement has received approval from the Israeli Antitrust Authority (subject to certain conditions), but remains subject to final approval from the Israeli Ministry of Communications. In the interim, HOT Mobile has entered into the RoU Agreement with Partner which gives HOT Mobile a right of use over Partner’s mobile communication network for the purpose of providing nation-wide mobile coverage to our customers.

The Network Sharing Agreement with Partner is valid until December 31, 2028, and provides for automatic renewals in five-year increments after December 31, 2028. We have also entered into a roaming contract with Vodafone pursuant to which Vodafone provides our 3G customers with international roaming capabilities. For further details see “*Description of our Business—Material Contracts—Agreement with Pelephone, Vodafone and Belgacom relating to mobile roaming services*” and “*—Material Contracts—Mobile Network Sharing Agreement with Partner in Israel*”. Our Israeli cable-based business, which we run under the “HOT” brand, has allowed our mobile business to benefit from certain synergies including in respect of retail distribution and brand awareness.

Currently, our UMTS network permits data transfer at speeds of up to 42 Mbps which we are seeking to increase to 84 Mbps in the future. In addition, the Israeli Ministry of Communications has initiated a tender process for a total of eight frequency bands in the area of 1,800 MHz that will enable delivery of mobile services using 4G-LTE technology. On November 18, 2014, HOT Mobile submitted its offer in response to the tender. On January 12, 2015, the Israeli Ministry of Communications informed HOT Mobile that based on the results of the tender it would be awarded a frequency bandwidth of 2X5MHz in the 1.8 GHz spectrum, for a license fee of NIS 34.5 million (up to half of which may be paid by way of provision of a bank guarantee, which may be refunded, in whole or in part, upon HOT Mobile reaching certain market share milestones). The tender results will be brought before the Minister of Communications for approval. In the event that such approval is awarded and we acquire such frequencies, we expect to begin developing infrastructure within the arrangements we have entered into with Partner (subject to regulatory approvals) that would allow us to commercialize such services. The conditions to the 4G-LTE tender also clarified that a licensee may enter into a network sharing agreement with another licensee subject to certain conditions. As a result, HOT Mobile has updated its request for approval by the Ministry of Communication of the Network Sharing Agreement with Partner. It was also clarified that Golan Telecom and HOT Mobile may request to replace the deployment plan they attached to the tender for the UMTS frequencies with a deployment plan for 4G, provided investment in the 4G network is equivalent to investment in the original deployment plan they committed to, and that they will only use frequencies assigned to them in the 4G tender for the provision of 4G services.

We believe that, because of our extensive fixed-line network and our advanced UMTS network, upgrading our mobile network to the 4G standard will involve significantly less capital expenditure (or investment in the newly formed limited partnership to be set up in Israel pursuant to the Network Sharing Agreement between HOT Mobile and Partner) than we incurred to roll- out our 3G network because our mobile network infrastructure will require minimal upgrading as compared to some of our competitors. We believe these factors will allow us to quickly market the latest 4G-LTE-based packages to our customers. The Ministry of Communications has allowed existing operators wishing to upgrade their systems immediately to temporarily use the frequency bandwidth of 5 MHz (X2) in the area of 1,800 MHz LTE technology (subject to certain conditions), and, as such, HOT Mobile is intending to launch such 4G-LTE services to customers in the coming months.

The following table sets forth details regarding the spectrum allocated to us and our competitors for the provision of mobile services.

Service Provider	UMTS Bandwidth (Mhz)	GSM Bandwidth (Mhz)
HOT Mobile	2,100	—
Pelephone.....	850 - 2,100	—
Cellcom.....	850 - 2,100	1,800
Partner.....	900 - 2,100	900 - 1,800
Golan.....	2,100	—

Portugal

In Portugal, we benefit from a state-of-the-art HFC cable network that passed 909,000 homes as of December 31, 2013, and 909,000 homes as of September 30, 2014 and covered certain Portuguese cities in over 13 districts and 70 municipalities. The company is licensed by ANACOM to provide public cable television services in 233 Portuguese municipalities, as well as public telecommunication network and fixed telecommunication services. We use this network to provide residential pay television, broadband internet access and fixed-line telephony services. It extends over 12,000 kilometers and includes 3,600 kilometers of optical fiber. We have upgraded approximately 99% of our network to Docsis 3.0 and expect to reach 100% following certain upgrades that are currently underway. We fully own our distribution networks, head- ends and drops, which gives us significant flexibility to deploy and constantly improve our product offering.

Our acquisition of ONI enriched our assets base with the second largest B2B cable network in Portugal covering approximately 85% of the Portuguese population. We operate a nationwide backbone supported by approximately 9,150 kilometers of fiber pairs and 431 points of presence supporting 9,605 customer sites, using OTN (Optical Transport Network) connections comprising several 10 Gbit/s signals over a single optic-fiber pair with speeds between 155 Mbit/s and 10 Gbit/s. Radio links complement our access portfolio, with 172 point- to-point systems in service. In addition, our network is connected to Spain through the 10G SDH Iberian ring and a new 10G PTN connection. Furthermore, we use SDH to support Ethernet services using its wide coverage (1200 NE) and the intrinsic automatic protection in case of failure by switching to an alternative route in less than 50 ms. In the two main metropolitan regions, Lisbon and Porto, Packet Transport Network (PTN) technology backbones are providing native Ethernet clients accesses through optic-fiber, usually with 1 Gbit/s of bandwidth. Within the cities and in the B2B environment, FTTH is deployed with direct extension of PTN, enabling up to 100 Mbps and 1G VPN/VLAN services. A wider coverage is attained with xDSL

technologies in operation in 139 co-location sites and, since June 2013, symmetric Ethernet services are supported through Ethernet Last Mile (EFM) technology with a theoretical reach of 120 Mbps but being deployed for 10 Mbps (four pairs).

Belgium and Luxembourg

We provide our pay television, broadband internet access and fixed telephony services to both residential and business customers who reside in our service area through our combined broadband HFC network which consists of a fiber backbone with local loop connections constructed of coaxial cable with a minimum capacity of 860 MHz in Brussels and 550 MHz in Luxembourg. We are the only operator with a fully secured backbone between Paris/Luxembourg and Brussels with excess capacity, which can be used to exchange all channels carried in France, Belgium or Luxembourg.

In Brussels, our network assets include approximately 513 kilometers of fiber backbone. We own the primary and secondary fiber backbone and the fiber and coaxial cable. In Luxembourg, our network assets include approximately 450 kilometers of fiber backbone. We own the primary and secondary fiber backbone and the fiber and coaxial cable.

Our fiber backbone is currently running All-IP and carries all of our communications traffic with dedicated bandwidth for the various types of traffic. Customers connect to the network through a coaxial connection from one of our nodes. Amplifiers are used on the coaxial lines to strengthen both downstream and return path signals on the local loop. On average, approximately 171,000 homes in Brussels and 42,000 homes in Luxembourg are served by each of the approximately 240 optical nodes in the Brussels region, approximately 30 optical nodes in the AIESH region and approximately 96 optical nodes in Luxembourg. Network quality can deteriorate as customer penetration rates on any particular node increase above a certain number. When required, the scalability of our network enables us to address this problem, within limits, through node “splits” in which we install additional equipment at the node so that the same capacity serves approximately half of the initial homes.

In Brussels and in Luxembourg, we built our network pursuant to agreements with municipalities which authorized us to build and operate a television cable network over the territory of the municipality. In Luxembourg, in certain municipalities, we directly acquired the network from private owners, while in other instances the network is owned by the municipality which we operate pursuant to a concession agreement. Ownership of the network between the cable operator and the municipality during the term of the agreement can also depend on who originally invested in the network.

Our HFC cable network passed 171,000 homes in Brussels and 42,000 homes in Luxembourg as of December 31, 2013, and 171,000 and 42,000 homes as of September 30, 2014, respectively.

Our entire cable network in Brussels and Luxembourg is fully EuroDocsis 3.0-enabled. Within the network we acquired in late 2012 in the County of Hainaut in Belgium, we have already upgraded approximately 100% of homes passed to triple-play capability, approximately 19% of our subscribers in the area are already subscribed to one of our multiple-play products and approximately 39% now receive digital services. We provide mobile services utilizing the mobile network of Mobistar in Belgium (the second largest mobile service provider in Belgium) pursuant to mobile virtual network operator (“MVNO”) agreements.

French Overseas Territories

Following our acquisition of Outremer, our proprietary infrastructure in the French Overseas Territories now includes mobile networks based on GSM/GPRS/EDGE and UMTS/HSPA technologies enabling us to deliver 2G and 3G services respectively, with coverage throughout the French Overseas Territories. Our acquisition of Outremer also enriched our asset base with fixed-line xDSL networks, over which we provide internet, fixed-line telephony and IP television services which are available to most households in the region. In Guadeloupe, Martinique and La Réunion, our fixed-line xDSL network is supplemented by WiMAX capability enabling the delivery of last-mile wireless broadband internet access. In addition, we have invested in IRUs and leases of submarine cable capacity, which connect our terrestrial mobile and xDSL fixed-line networks to international routes.

In addition to mobile and fixed-line xDSL networks, we also own a HFC cable network in Martinique and Guadeloupe, which, as of December 31, 2013, passed 73,312 homes in Martinique (covering approximately 57% of Martinique by homes passed) and 80,831 homes in Guadeloupe (covering approximately 53% of Guadeloupe by homes passed). As of September 30, 2014, our HFC cable network passed 73,601 homes in Martinique (covering approximately 57% of Martinique by homes passed) and 104,663 homes in Guadeloupe (covering approximately 69% of Guadeloupe by homes passed). We are currently in the process of upgrading our network to EuroDocsis 3.0 and have upgraded 95% of our network as of September 30, 2014, compared to 49% as of September 30, 2013.

It is expected that ARCEP will initiate an application process to award spectrum for the provision of 4G-LTE mobile telephony services in the first quarter of 2015 in the Caribbean area and by the beginning of the third quarter of 2015 in the Indian Ocean. In the event we are awarded such 4G-LTE spectrum, our ability to provide 4G-LTE mobile services to complement our existing 2G and 3G mobile services in the French Overseas Territories will depend in part on our ability to upgrade our mobile network and roll-out a 4G-LTE network, which could involve a significant amount of capital expenditure. Based on current plans, we expect that we would need to invest approximately €27 million (net of tax subsidies) from 2014 through to 2016 to upgrade our networks to roll-out LTE mobile services. In the Indian Ocean (Reunion and Mayotte), Outremer will dispose of its mobile operations. In those territories expected 4G investments represented €6.5 million in 2015 and €5.1 million in 2016

Dominican Republic

Through ODO, we own the highest quality 3G mobile network in the Dominican Republic, based on a public analysis by an independent consultant. Our previous capital expenditures have resulted in what we believe to be superior coverage and network reliability.

We offer our mobile services through our 2G GSM/GPRS, 3G UMTS/HSPA and 4G-LTE mobile access network comprising approximately 1,205 antenna sites with approximately 1,378 2G GSM/GPRS base stations (BTS), approximately 880 3G UMTS/HSPA base stations (node-B) and, 180 4G-LTE mobile base stations as of September 30, 2014.

ODO has nationwide coverage through its high quality 2G network (96% and 96.4% population coverage as of September 30, 2014) which is fully EDGE capable. ODO installed five new 2G sites during the nine-month period ended September 30, 2014. Additional sites have also been identified for future installations. ODO achieved 77% population coverage through its 3G network as of September 30, 2014, offering download speeds of up to 42 Mbps. The roll-out of the 3G network is on-going and ODO aims to cover approximately 80% of the population by 2015.

In July 2012, ODO became the first operator in the Dominican Republic to commercially launch its 4G-LTE network. However, certain disputes with competitors (over allegations of anti-competitive practices) resulted in restrictions being imposed on ODO's 4G-LTE network by Indotel, thus slowing its 4G-LTE deployment plans. These disputes have now been resolved and the Indotel-imposed restrictions have since been removed, and as a result ODO now offers nationwide 4G-LTE services on mobile devices through the 4G-LTE spectrum it offered services through prior to the ODO Acquisition. It is our intention, once the ODO and Tricom merger receives the required regulatory approval, to migrate ODO's 4G-LTE services onto the spectrum in the 1,900 MHz frequency licensed to Tricom since the conclusion of the 4G-LTE public frequency auction in May 2014. Pursuant to this, ODO has filed a technical pilot application with the relevant regulatory body which, if approved, would allow ODO and Tricom to work on the technical logistics of the proposed 4G-LTE migration ahead of their merger.

As of September 30, 2014, ODO had 180 4G-LTE-enabled mobile sites (offering approximately 32% population coverage). In light of the favorable resolution of the spectrum capacity issues, ODO now plans to increase its 4G-LTE population coverage. ODO benefits from a scalable multimode 3G network, which is easily upgradable to 4G. The 4G-LTE roll-out has been predominantly driven by demand in the B2B segment, with the focus of coverage being centered on the Santo Domingo and Santiago regions, where a majority of clients are based.

We are rolling out a backbone transmission optic fiber to connect high density areas and progressively decommission the SDH microwave links while sustaining future traffic growth. ODO owns an optical backbone that management believes will allow ODO to meet future increases in data traffic. Our transmission backbone includes underground fiber along the main communication axis in the Dominican Republic (Santo Domingo, Santiago and Puerto Plata). Additionally, ODO has identified other high density traffic locations to be connected with fiber in the future. Fiber is being rolled-out both below and above ground, in an on-going effort to optimize cost and deployment time. At the same time, in remote areas where the deployment of fiber is expensive, ODO is making use of microwave backhaul.

Tricom provides its pay television, broadband internet and fixed-line telephony services through its HFC cable, xDSL and GPON networks. With respect to fixed services, Tricom benefits from an integrated platform which includes networks based on HFC, copper and fiber technologies while it prioritizes the modernization and expansion of its entirely digital cable network. As of December 31, 2013, Tricom had upgraded 77% of its cable network to bi-directional capability. Tricom has upgraded a further 10% of its cable network to bi-directional capability as of September 30, 2014, with a substantial majority of homes passed on 750 MHz or 1,000 MHz. Up to a maximum of 750 homes are served by each optical node in Tricom's network. Tricom's entire cable network is digital and capable of supporting HD and DVR services. Tricom is continuing the expansion of its cable network into key cities that are still underpenetrated and where proprietary fiber optic is already present, offering growth potential. To this end, it relies on an in-house team which designs approximately 80 kilometers of network each month, as well as third-party construction teams which implement in-house design and build approximately 70 kilometers of network each month. Tricom has in-house capability to

activate, and perform quality control procedures on its network. In addition, Tricom has focused on maintaining its xDSL network to serve customers in areas not reached by its cable network.

Tricom provides its mobile telephony services separately through its wireless network and has 25 MHz of spectrum in the 850 MHz frequency, allowing it to offer its customers 3G mobile services, and 30 MHz of spectrum in the 1,900 MHz frequency, allowing it to offer 4G-LTE mobile services. Tricom has an additional 30 MHz of spectrum in the 3,500 MHz frequency where it offers some WiMAX coverage (East coast). Tricom launched 4G mobile services in May 2013. Tricom's network in the 850 MHz and 1,900 MHz frequencies cover approximately 86% and 60% of the Dominican Republic population, respectively, as of September 30, 2014. Tricom's 4G and 3G services are capable of supporting mobile download speeds of up to 70 Mbps and 3 Mbps, respectively.

Suppliers

While, historically, purchasing activities were typically carried out locally at the various entities comprising our business, we have recently begun to globalize and streamline our procurement processes by combining our aggregate purchasing power. The purpose of our centralization efforts is to leverage the combined scale of the Altice Group operations located in different geographies and thus negotiate more favorable pricing and other commercial terms from suppliers of certain hardware, software, pay television content and other products used in all of our operations than each of our businesses could individually secure. In order to put the centralization process on a more formal footing, we are currently in the process of establishing a global purchasing subsidiary. We believe that the continued integration and streamlining of our global procurement processes will allow us to realize significant cost savings going forward.

We have relationships with several suppliers that provide us with hardware, software and various other products and services necessary to operate our businesses. We use a limited number of subcontractors to maintain our network, operate our call centers and supply, install and maintain installed consumer and on-site business and public sector terminals, with Group employees performing only a small portion of installations. Certain services can be self-installed by our customers, but most still require a professional installer. Our agreements with third-party providers generally require that the subcontractors maintain certain quality levels and use trained personnel, and we monitor the efficiency and quality of service provided by our subcontractors on a regular basis.

We currently deploy the set-top box LaBox in our operations in Belgium, Luxembourg and Portugal, and we also introduced LaBox in Israel in March 2014. We purchase LaBox set-top boxes from Sagemcom for use across our operations. We also continue to procure set-top boxes for use in certain of our operations from Technicolor. The Altice Group generally weighs in on the negotiation of each individual contract entered into by our businesses in order to leverage its combined purchasing power and generally ensure the same terms and conditions are agreed upon across its operations. While we progress the globalization of our procurement functions, our businesses continue to purchase certain of the products and services required for their operation under locally negotiated contracts for a variety of reasons, including the need for such products and services being specific to each locality.

In Israel, our key infrastructure, hardware and software suppliers for our cable-based operations include Bezeq which provides us with design, installation and maintenance services relating to certain parts of our cable network which pass through ducts and poles owned by Bezeq; Genband, Bynet and BroadSoft which provide us with equipment and services relating to telephony switches; NDS Limited, a subsidiary of Cisco, which provides us with equipment and services relating to unified encryption systems; Technicolor and Sagemcom, which provide us with set-top boxes including, in respect of Sagemcom, the HOT Box; and Nagravision, which provides us with software for set-top boxes.

We have entered into a number of reciprocal interconnection agreements with fixed-line telephony providers in Israel, mobile operators in Israel and internal long-distance telephony operators. We have also entered into an agreement with Convergys in relation to certain billing-related services for our cable services. In addition, we contract with suppliers for the purchase of television programming content that we package and broadcast under the HOT suite. We also purchase rights to broadcast independent Israeli and international channels on our network and content for our VoD service. We use a limited number of subcontractors to install broadband internet, telephony and digital television equipment in customer homes. Our agreements require that the subcontractors maintain certain quality levels and use trained personnel, and we monitor the efficiency and quality of the service provided by our subcontractors on a regular basis. With respect to our mobile operations, we have engaged Nokia Solutions and Networks ("NSN") as a turnkey contractor to plan and build the new UMTS network. We have entered into an agreement with Pelephone, which has provided us with in-country roaming services for our 3G mobile operations since we began offering mobile services in Israel in May 2012 and also have roaming agreements with several foreign mobile operators. In November 2013 we entered into the Network Sharing Agreement with Partner pursuant to which HOT Mobile and Partner will own equal shares of a newly formed limited partnership, which shall hold, develop and operate an advanced shared mobile network for both companies. The Network Sharing Agreement, which has received approval from the Israeli Antitrust Authority (subject to certain conditions), but remains subject to final approval from the Israeli Ministry of Communications, will enable HOT Mobile and Partner to share antennas and frequencies and facilitate optimum utilization of the spectrum. In the

interim, HOT Mobile has entered into the RoU Agreement with Partner which gives HOT Mobile a right of use over Partner's mobile communication network for the purpose of providing nation-wide mobile coverage to our customers. In December 2013, HOT Mobile and Pelephone amended their underlying agreement repealing the exclusivity clause to which HOT Mobile was subject to. This agreement will allow HOT Mobile to exercise its rights under the Network Sharing Agreement with Partner once final regulatory approval by the Ministry of Communications is received. We have agreements with various suppliers for the purchase of 3G compatible handsets. Comverse supplies us with certain services relating to an integrated billing and customer relation management ("CRM") system for our 3G mobile operations. The main suppliers for our iDEN-based mobile operations are Motorola Solutions, which owns the rights to the iDEN technology and is the primary manufacturer of infrastructure equipment for iDEN technology, and Motorola Mobility which manufactures end-user equipment for iDEN technology.

The suppliers to our residential business in Portugal include Portugal Telecom and EDP, which provide us with services relating to certain parts of our cable network which pass through ducts and poles owned by them; Fibnet and Aveicabo, which provide us with installation services and services relating to the maintenance of our network; Randstad, which provides us with contract and payroll management services relating to our sales agents as well as call center functions; as well as NSN and Genband, which provide us with hardware as well as maintenance and support for network equipment. For our recently-acquired Portuguese B2B business, we have a set of long-term contracts for our main infrastructure (sites and fiber) with Rede Eléctrica Nacional and Electricidade de Portugal, in addition to the use of our own fibers, a contract for ducts and land with BRISA, the main Portuguese highway operator, and also leased circuits from PT Portugal. In Spain, we lease bandwidth and optical wave-lengths from British Telecom and UFINET enabling our presence in the Iberian Peninsula and Madrid. Further key suppliers of our Portuguese B2B business include Alcatel-Lucent, Cisco, Corient, Sonus.HP, Ruckus, Dell and Axis.

In Belgium and Luxembourg, Numericable France is our main supplier of hardware and software necessary to operate our business. Pursuant to a services agreement we entered into with Numericable France on the date of the acquisition of Coditel by us, Numericable France provides us with technical, engineering and support services, while also allowing us to benefit from its purchasing power for equipment, in particular set-top boxes, content and IP traffic. Other key suppliers of our IT needs include InfoCABLYS, which provides us with hardware and the billing and customer care software "ProCable", and Sage, which provides us with support for its enterprise resource planning system that we use. In Belgium, we use subcontractors to install internet, fixed-line telephony and digital TV equipment in subscriber homes, in addition to having a small portion of installations performed by our own employees. In Luxembourg, we use both our own employees and subcontractors to perform installation services. Certain services can be self-installed by our customers but most require a professional installer. Our agreements require that the subcontractors maintain certain quality levels and use trained personnel, and we monitor the efficiency and quality of service provided by our subcontractors on a regular basis.

In the French Overseas Territories, our key suppliers are the telecom operators France Telecom/Orange, SRR and Digicel to which we pay interconnection fees and purchase capacities from for both our cable-based and mobile activities. With respect to our recently acquired mobile operations, we historically source our handsets from Samsung and Alcatel and purchase our network infrastructure and 2G/3G base stations from ZTE. In anticipation of the potential release of frequencies for 4G-LTE, we requested quotes from major original equipment manufacturers. Regarding our cable-based operations, we purchase rights to broadcast channels on our network and content for our TV service and we use only one subcontractor, ERT, to install broadband internet, telephony and digital television equipment in subscriber homes. We procure our xDSL modems and set-top boxes from Pace (formerly known as Bewan) and Sagemcom, while we purchase our cable modems and set-top boxes from Numericable France which sources from Netgear and Technicolor, respectively.

In the Dominican Republic, ODO has entered into agreements with a variety of service and outsourcing suppliers to conduct our ongoing business. These services include supply of software licenses, call center support, data management and human resources consulting, among others.

Material Contracts

The agreements described below are of material importance to our Group. The overview of each agreement set forth below is an overview of the material terms of such agreements as in effect as of the date of these Listing Particulars.

Agreement with the State of Israel relating to ownership of our cable network

In July 2001, our predecessor companies entered into an agreement with the State of Israel pursuant to which they agreed to waive all claims against the State of Israel arising out of the grant of a satellite broadcast license to D.B.S. Satellite Services (1998) Ltd, an associate of Bezeq which provides satellite technology based multi-channel television services under the YES brand. In exchange, the State of Israel agreed to waive all of its claims and rights concerning the cable infrastructure, such that our predecessor companies would hold all rights and title to the cable infrastructure in their

respective concession areas and have the right to operate the cable network even after the end of the concession periods. The agreement, which was transferred to our Group as part of the Israeli cable consolidation process, sets out a payment mechanism based on revenues deriving from the use of the cable infrastructure pursuant to which we are required to make annual payments to the State of Israel until January 1, 2015. In addition, we are required to pay certain amounts to the State of Israel, as provided in the agreement, in the event we sell any of our cable network assets or operations carried out via the cable infrastructure or in the event we issue securities through a public offering, investment or similar transaction. In each year ended December 31, 2011, 2012 and 2013, and in the nine months ended September 30, 2014, we incurred expense related to the agreement with the State of Israel of NIS 57 million, NIS 58 million, NIS 58 million and NIS 41 million. We have provided a second ranking floating charge over all of the assets of HOT to the State of Israel to secure our payment obligations under the agreement.

Provision of certain bank guarantees to the State of Israel relating to performance of certain license terms

In relation to the addition of frequencies to our mobile license enabling us to provide UMTS-based 3G services, we were required to pay to the State of Israel a total license fee of NIS 705 million, out of which we paid NIS 10 million at the time of receiving the license. For the remaining NIS 695 million, we were required to provide the State of Israel with a bank guarantee. Under the terms of the license, such remaining license fee was to be reduced by one-seventh for every per cent. of market share gained by HOT Mobile since the date of the license. The market share of HOT Mobile is calculated as the average of: (i) the ratio of HOT Mobile subscribers (including UMTS and iDEN) in the private sector to the total number of mobile subscribers in the private sector; (ii) the ratio of the number of outgoing mobile call minutes initiated by subscribers (including UMTS and iDEN and call minutes in the same network) of HOT Mobile in the private sector to the total number of outgoing mobile call minutes (including call minutes in the same network) by all mobile subscribers in the private sector; and (iii) the ratio of revenues from HOT Mobile subscribers (including UMTS and iDEN) to the total revenues from all mobile subscribers in the private sector. In April 2013, HOT Mobile received a notification from the Israeli Ministry of Communications clarifying the meaning of certain components of the market share calculation, namely “subscribers in the private sector”, “number of outgoing mobile call minutes” and “revenues”. The two measuring periods for market share gain run from the date of the license to September 26, 2013, and September 26, 2016, respectively and the remaining license fee, which is the lowest fee as calculated on each of the testing dates, would be payable three months after the second testing date. As a condition for the bank guarantee, HOT Mobile and HOT signed an irrevocable letter of undertaking in favor of the bank that issued the guarantee, which is secured by a pledge of all of the assets of HOT Mobile which HOT Mobile is permitted by law to pledge. In addition, we have agreed to indemnify the State of Israel for any monetary liability that it incurs as a result of our use of the mobile license and have entered into an insurance agreement to be insured for any such liability. As of the first testing date on September 26, 2013, we have achieved a market share calculated in accordance with the license agreement that entitles us to a deduction of the entire amount of the NIS 695 million license fee outstanding. Accordingly, we requested the Israeli Ministry of Communications to reduce the amount of the bank guarantee to an amount of NIS 80 million as guarantee of our obligation to achieve certain territorial coverage requirements under our license. On November 21, 2013, the Israeli Ministry of Communications notified HOT Mobile that the license fees shall be decreased to NIS 10 million (which has already been paid) and the bank guarantee shall be decreased from the amount of NIS 695 million to an amount of NIS 80 million. We have also provided bank guarantees to the State of Israel for an amount of approximately NIS 27 million and \$8.4 million as surety for the compliance with the terms of our broadcasting licenses and fixed-line licenses, respectively.

Agreements with Bezeq relating to installation and maintenance of portions of our cable network

In the 1990s, certain of our predecessor companies entered into agreements with Bezeq for the purpose of the planning, installation and maintenance of the cable networks pursuant to which they intended to provide cable television services. The cable networks and the related agreements with Bezeq were transferred to our Group as part of the cable consolidation process. The agreements are valid until we have valid broadcasting licenses. For further details regarding the term of our broadcasting licenses, see “*Regulatory—Israel—Television—Overview*”.

Under the terms of the agreements, Bezeq is required to maintain the portion of our cable network that passes through its ducts on an on-going basis and is also responsible for repairing breakdowns in the network. The scope of the agreements extends to the possibility of expanding the cable network to additional sites, connecting new homes and connecting new neighborhoods. Bezeq is permitted to terminate the agreement if we breach the agreement and have not cured such breach within six months of written notice from Bezeq. The agreements set forth a payment mechanism pursuant to which we pay Bezeq an annual amount representing capital expenditure and maintenance costs based on the length of the cable network passing through its ducts as well as one-time payments in respect of certain services provided by Bezeq. Capital expenditure costs are staggered over a 12-year period and the amounts payable to Bezeq are accordingly reduced by approximately 65% after 12 years of the delivery of each segment of the cable network. We incurred total costs of NIS 46 million, NIS 48 million, NIS 47 million, and NIS 36 million in 2011, 2012, 2013, and the nine months ended September 30, 2014, respectively, for services provided by Bezeq under these agreements.

Agreement with Nokia Solutions and Networks relating to installation of the UMTS network

In June 2011 we entered into an agreement with NSN for the establishment of the new UMTS network infrastructure pursuant to which we provide 3G mobile services to our customers. Under the terms of the agreement, NSN has agreed to plan and erect the new network infrastructure on a turnkey basis. NSN has also agreed to provide maintenance with respect to our mobile network.

In the first stage, completed in 2012, NSN met its requirement to complete the network with coverage extending to 20% of the Israel population according to our mobile license requirements regarding the first check point. During 2013 and 2014, several amendments were made to the agreement with NSN postponing payments due under the agreement, in return for a debt obligation which was issued in favor of NSN and guaranteed by HOT. In this framework of agreements HOT Mobile also confirmed receipt of a final installment of key parts in relation to the aforementioned project.

In July 2014, an agreement was signed between HOT Mobile and NSN for the provision of equipment, hardware and software. In addition, HOT Mobile acquired construction and integration services of the LTE core network for the provision of domestic roaming services and for adapting its network to the requirements of the Networks Sharing Agreement with Partner. Under this agreement, the maintenance agreement between HOT Mobile and the vendor was renewed for 2014-2015.

We expect that the total amount payable under the agreement with NSN to be lower than originally anticipated due to our Network Sharing Agreement with Partner as a result of which our need to build out a new UMTS network will reduce.

Interconnection Agreements

Interconnection is the means by which users of one telephony network are able to communicate with users of another telephony network and, as the case may be, through a third telephony network. For a subscriber located on one telephony network to complete a telephone call to an end-user served by another telephony network, the subscriber's network service provider must interconnect either to the end-user's network, or to the network that transfers the call to the end-user's network. Typically, the network transferring the call and the end-user's network charge the subscriber's service provider a fee to transfer or to terminate the communication. Interconnection fees are typically regulated by the telecommunications regulator in each of the countries in which we operate. Regulators also commonly impose on all participants in the fixed-line telephony and mobile telephony markets an obligation to negotiate in good faith interconnection agreements with every requesting operator who is seeking to provide a publicly available electronic communication service. Generally, the cost of interconnection fees that we pay is taken into account in the price we charge our subscribers.

We have entered into various domestic and international reciprocal interconnection agreements for our fixed-line telephony, mobile operations and ILD services with other providers of electronic communications services. Our interconnection agreements generally have terms that continue for the duration of the parties' licenses to pursue telecommunication activities and may be terminated in the event of a material breach or the commencement of liquidation or insolvency proceedings. For the year ended December 31, 2013, on a historical consolidated basis, we incurred interconnection fees of €89.8 million. In the nine months ended September 30, 2014, we incurred interconnection fees of €74.8 million.

Agreement with Pelephone, Vodafone and Belgacom relating to mobile roaming services

In November 2011, HOT Mobile entered into an agreement with the mobile operator Pelephone, a subsidiary of Bezeq, pursuant to which Pelephone agreed to provide domestic roaming services for 3G users to HOT Mobile and HOT Mobile agreed to exclusively purchase such services from Pelephone. The agreement enabled us to provide 3G mobile services to our mobile customers while we continued to build-out our UMTS network in Israel. The cost for the services provided by Pelephone was based on agreed rates and depends on the actual usage of Pelephone's mobile network by our 3G customers in Israel. The agreement with Pelephone is scheduled to expire in December 2014, subject to notice.

In December 2013, HOT Mobile and Pelephone amended their underlying agreement repealing the exclusivity clause which HOT Mobile was subject to. See "*Description of Our Business—Material Contracts—Mobile Network Sharing Agreement with Partner in Israel*".

In addition, we have entered into a roaming agreement with Vodafone through which we receive roaming services for 3G around the world including approximately 500 mobile networks. We are also in the process of negotiating and signing roaming contracts directly with individual mobile operators in various countries. Our roaming agreement with Vodafone enables our Israeli 3G mobile customers to access other mobile networks while abroad. Although the particular terms depend on the country in which roaming services are accessed, the agreement regulates billing and accounting, settlement procedures, customer care, technical aspects of the roaming agreement, security and connectivity. The agreement

automatically renews until one of the parties gives written notice of termination and may be terminated in the event of a material breach or the commencement of liquidation or insolvency proceedings.

In November 2012, our recently acquired French Overseas Territories business entered into an international roaming agreement with Belgacom International Carrier Services (“BICS”) for the benefit of our 2G and 3G subscribers. The agreement is scheduled to expire in November 2015. The cost for the services provided by BICS is based on agreed rates and depends on the actual usage of BICS’ mobile network by our customers travelling abroad.

We have also entered into international roaming agreements with various operators of GSM networks around the world, allowing our Israeli iDEN customers to make calls while overseas using a GSM compatible phone which we provide.

Mobile Network Sharing Agreement with Partner in Israel

On November 8, 2013, HOT Mobile entered into a network sharing agreement (the “Network Sharing Agreement”) with Partner pursuant to which HOT Mobile and Partner will own equal shares of a newly formed limited partnership (“JV Entity”) that will hold, develop and operate an advanced shared mobile network for both companies. Each party is required to maintain and operate its own core network and independently provide mobile communication services, including marketing and sales of such services, to its respective customer base.

The Network Sharing Agreement has received approval from the Israeli Antitrust Authority subject to certain conditions including, among others, the prevention of the transmission of business information and technology (which does not require joint activity), and conditions relating to the management of the JV Entity. The decision further stipulated that each party shall be entitled at all times, and at its sole discretion, to call a third party for provision of mobile communication services which are used in the core network of such party, and that the JV Entity will not be a party to the agreement and shall not be entitled to payments made thereunder.

Further, from May 22, 2021, or six years from the date on which final approval of the Ministry of Communications is given, whichever is earlier, the Commissioner may notify the membership in writing that the decision to approve the application for the Network Sharing Agreement is revoked if the Commissioner finds the partnership, its existence or its actions harms competition. The Network Sharing Agreement remains subject to final approval from the Israeli Ministry of Communications, the decision of which is expected to be made after the outcome of the 4G-LTE tender process is decided.

The Network Sharing Agreement, among other things, regulates the management and development of the shared network and the management and governance of the JV Entity (including a mechanism for appointing directors, the approval of business plans and certain decisions that require the approval of both parties). As consideration, HOT Mobile is required to pay Partner a specified one-time amount by January 1, 2017, and, thereafter, each party will bear half of the capital expenditures required for the purpose of the establishment and upgrade of the shared network, while the shared network operational expenditures will be allocated in accordance with a prescribed mechanism based, *inter alia*, on the traffic volume usage of each party of the shared network. HOT has issued a guarantee for HOT Mobile’s obligations under the Network Sharing Agreement and the Group may be required to provide an additional guarantee or a bank guarantee to Partner in the event of the downgrade of the Group’s corporate rating by certain specified levels.

The Network Sharing Agreement with Partner is valid until December 31, 2028, and provides for automatic renewals in five-year increments after December 31, 2028 (unless either party notified its intention to terminate the agreement by 24 months’ notice prior to each extension period). However, at any time after the eighth anniversary of the effective date of the Network Sharing Agreement, either party may terminate the agreement by providing 24 months’ prior notice. The Network Sharing Agreement may also be terminated by a non-defaulting party upon certain specified events, including a material breach, failure of a party to meet its funding obligations, termination of a party’s license by the Israeli Ministry of Communications and the occurrence of certain insolvency events. The Network Sharing Agreement also provides for an exit plan upon termination.

HOT Mobile and Partner have also entered into a right of use agreement (the “RoU Agreement”) granting HOT Mobile a right of use over Partner’s mobile communication network for the purpose of providing nation-wide mobile coverage to our customers pending implementation of the Network Sharing Agreement. In connection with our entry into the Network Sharing Agreement and the RoU Agreement, we have recently entered into an agreement with Pelephone pursuant to which we are no longer tied exclusively to Pelephone.

We expect that arrangements we have entered into with Partner will result in savings relating to roaming, network and maintenance expenses and optimize the amount of capital expenditures we are required to incur in relation to the build-out of our UMTS network. We have already experienced savings relating to roaming costs under our RoU Agreement for the nine months ended September 30, 2014. However, there can be no assurance that we will be able to

obtain the final, outstanding regulatory approvals or otherwise be able to implement the arrangements we have entered into with Partner in a timely or cost-effective manner.

Agreement with NDS relating to purchase of a unified encryption system

In February 2007 HOT entered into an agreement with NDS (“NDS”) pursuant to which NDS supplies certain software and services for the implementation of a unified encryption system which enables HOT to provide pay-television services, control access to particular pay-programming packages and charge fees on an individual subscriber basis. This system encrypts transmitted signals sent to customers and customers decrypt the signals using a set-top box which allows them to receive the pay programming offered. The agreement also requires NDS to provide certain support and maintenance services related to the encryption system. The agreement is for a term of 10 years although HOT has the right to terminate the agreement with respect to the support and maintenance services after five years. In April 2011 the agreement was amended to expand the range of services to be provided by NDS in order to include encryption systems for a new type of set-top box provided by Technicolor. HOT is required to pay NDS an annual fixed amount for delivery of the encryption systems and related software licenses and provision of support services in addition to royalties and a fee for each set-top box with encryption technology. On February 17, 2013, HOT sent a notice of termination of the agreement to NDS. The notice was sent in view of negotiations between the Group and the Cisco group (“Cisco”), the parent of NDS, regarding a new global contract. In response to the notice, HOT received a letter from NDS on March 5, 2013, stating that in its view the agreement could not be cancelled before July 2015. The parties are currently in the process of negotiating revised terms.

We are party to similar agreements with subsidiaries of Cisco, the parent company of NDS, across our operations in other regions. While we have not yet entered into a Group-wide supply contract with Cisco, we continue to weigh in on the negotiations of each of these contracts in order to achieve better prices by leveraging the Altice Group’s combined purchasing power and to ensure that the same terms and conditions are entered into by each of our businesses.

Agreements with Technicolor relating to purchase of set-top boxes

In October 2007 HOT entered into a memorandum of understanding with Technicolor for the purchase of set-top boxes manufactured by Technicolor. HOT formalized the understanding by entering into an agreement in 2009 and subsequently amended the agreement in June 2011 to include the purchase of set-top boxes that combine HD technology and recording capability functionality (known as the HD-PVR set-top box). Technicolor is responsible for the design, production and delivery of the set-top boxes and to ensure compatibility with the software developed for the “HD-PVR” set top-box. In consideration, HOT is obligated to pay Technicolor a fixed amount for each set-top box. The price of set-top boxes includes a warranty extending for three years covering the hardware and 12 months covering the software elements of the HD-PVR box. Technicolor is also required to provide hardware and software support and maintenance services after the expiry of the warranty period. The agreement is valid until May 2016.

We are party to similar agreements with Technicolor for the purchase of set-top boxes across our operations. While we have not yet entered into a Group-wide supply contract with Technicolor, we continue to weigh in on the negotiations of each of these contracts in order to achieve better prices by leveraging the Altice Group’s combined purchasing power and to ensure that the same terms and conditions are entered into by each of our businesses.

Agreements with Sagemcom relating to purchase of equipment

In March 2011 in Israel, HOT entered into an agreement with Sagemcom Broadband SAS for the development and purchase of a product which combines the functionality of an internet modem, telephony modem and wireless router (known as the HOT Box). Under the terms of the agreement, Sagemcom has agreed to develop the product and to grant licenses to use the product software. In consideration, HOT is obligated to pay Sagemcom a fixed amount for each set top box. Sagemcom is also required to provide a warranty and maintenance services under the agreement. The agreement is for a term of four years and is automatically renewed for periods of one year at a time unless one party notifies the other of its intention to terminate the agreement upon expiry of the current term.

We are also party to agreements with Sagemcom for the purchase of set-top boxes in Portugal, Belgium and Luxembourg. We introduced LaBox in Israel in March 2014. While we have not yet entered into a Group-wide supply contract with Sagemcom, we continue to weigh in on the negotiations of each of these contracts in order to achieve better prices by leveraging the Altice Group’s combined purchasing power and to ensure that the same terms and conditions are entered into by each of its businesses.

Agreement with Bezeq for the Provision of Transmission Services

In December 2012, an agreement was signed between HOT Mobile and Bezeq for the supply of various transmission services required for the purpose of providing radio mobile telephone services provided by HOT Mobile. The

agreement's validity is for a period of five years from April 1, 2013. HOT Mobile is entitled to terminate the agreement upon 120 days' prior written notice subject to an early termination fee.

In exchange for all of the services provided to HOT Mobile by Bezeq, HOT Mobile agreed to pay Bezeq a total of approximately NIS 62.2 million which will be paid over the term of the agreement.

Agreement with Comverse

In October 2011, an agreement was signed between HOT Mobile and Comverse Ltd. ("Comverse"), pursuant to which Comverse would provide a BSS system (an integrated billing system with a customer contact management (CRM) system) and related hardware, software and services to HOT Mobile, including operation and maintenance of the CRM system. In exchange for Comverse's services, hardware and software, we agreed to pay a total of \$12.5 million. The agreement is expected to be in effect for a period of approximately five years. In January 2012, the parties signed an addendum to this agreement, whereby Comverse committed to make seven additional employees available for the project (in lieu of the manpower that should have been made available for the project by us), against payment of \$500,000.

Content Purchase Agreements

Several different relationships govern the content that we provide to our cable television subscribers. Alongside original content produced for HOT, in Israel we also purchase transmission or retransmission rights for channels and content produced by third parties. We pay copyright and carriage fees to the foreign, national and thematic broadcasters carried on our cable television networks. In general, these fees are paid in part to copyright collection agencies and to broadcasters based on a combination of per program fees and the number of subscribers to our cable service. We also typically pay royalties based on our subscribers' usage of on-demand content. In Israel, we have entered into agreements with two authors' right societies, namely AKUM Association of Music Composers, Writers and Producers in Israel Ltd. (AKUM) and Israel Screen and Television Artists Royalties Company Ltd (TALI). We entered into agreements with AKUM in 2011 following an arbitration proceeding initiated by AKUM to resolve the mechanism for calculating annual royalties for the use of works whose rights are protected by AKUM. Under the present arrangements, which are valid until 2016, we have a license to broadcast works whose rights are protected by AKUM in consideration for which we have agreed to settle all of AKUM's claims from 2003 until 2010 with respect to past royalties and have also agreed on royalty rates for 2011 to 2016. In 2011, we signed an agreement with TALI providing for the payment of royalties between 2003 and 2014. As of the date of these Listing Particulars, this agreement has not been renewed.

The terms and conditions of our contracts governing the payments and content providers of copyright fees to broadcasters vary by jurisdiction. We also enter into transportation and distribution agreements with the commercial broadcasters. Through transportation contracts, we agree to carry a commercial broadcaster's signal across our fiber backbone to our head-end stations, where the signal is subsequently delivered to our subscribers. Broadcasters who transmit their signal to us by satellite can elect to deliver their signal directly to our head-end stations and, as a result, do not need to enter into a transportation agreement with us. We also enter into distribution arrangements with all of the commercial broadcasters whose channels we carry on our networks, pursuant to which we agree to carry the broadcaster's signal from the head-end station to our cable television subscribers. A variety of compensation arrangements have been made in respect of the contracts we enter into with the commercial broadcasters. In some situations, we do not charge the broadcasters any fee for transmitting their signal to our subscribers. Instead, the broadcasters benefit from increased advertising revenue they receive from reaching our basic cable television subscribers and we benefit by providing our subscribers added content. In certain situations, we pay broadcasters for the channels they transmit over our network. In other instances, we have entered into revenue-sharing arrangements or subscriber-based fixed fees. In addition to these arrangements, we have also entered into contracts with certain broadcasters pursuant to which we currently pay a fee in order to have the right to broadcast their signal on any digital cable television service that we may offer in the future.

Additionally, in Israel we purchase stand-alone programming from third-party content providers, for the purpose of including such programming in our "home" linear channels and/or our VOD services.

In addition to content purchasing, in Israel, we have co-developed shows and have also developed several show platforms for our HOT suite of channels. We believe that our involvement with local content production companies has allowed the HOT brand to benefit from the significant popularity of our television series, movies and shows among the Israeli population by leveraging the fame of the local actors and actresses in our marketing campaigns to promote our offerings. Further, in October 2013, we acquired Ma Chaîne Sport and SportV, French and Luxembourg operators of sports-themed Francophone television channels which produce and assemble their content.

Content Distribution Agreements

Ma Chaîne Sport and SportV entered into agreements with Numericable, Valvision, as well as certain of our subsidiaries, for the non-exclusive distribution of Kombat Sport, Ma Chaîne Sport, Ma Chaîne Sport Extreme, Ma Chaîne Sport Bien

Etre and Ma Chaîne Sport Tennis television channels in Belgium, Luxembourg, Portugal, France, Martinique and Guadeloupe. The contracts have a duration of five years with retroactive effect from January 1, 2013. Pursuant to these agreements, Ma Chaîne Sport and SportV receive annual fees, which are either fixed or subject to gradual yearly increases, from each of the operators. In addition, Ma Chaîne Sport and SportV are entitled to advertising revenues received from the broadcast of their television channels. The contracts can be terminated by any party in case of a breach of the contract by the other party not remedied within 60 days.

Certain Shareholder Arrangements

HOT Minority Shareholder Agreements

In October 2010, Cool Holding entered into separate agreements with Yedioth Communications Ltd. (“Yedioth”) and companies from the Fishman Group (collectively, “Fishman” and, together with Yedioth, the “HOT Minority Shareholders”), pursuant to which (i) Cool Holding acquired 4,565,493 shares of HOT from Fishman in March 2011 and 10,012,003 shares of HOT from Yedioth in November 2011 and (ii) Cool Holding agreed that, until the date that is three years from each such acquisition date, Cool Holding would not take any action which would cause HOT to become a private company or for its shares to be delisted from the Tel Aviv Stock Exchange, without receiving the consent of each HOT Minority Shareholder (the “Take-Private Consent Right”).

On November 5, 2012, in connection with the Take-Private Transaction, Cool Holding entered into separate agreements (each a “HOT Minority Shareholder Agreement”) with the HOT Minority Shareholders, pursuant to which (i) Cool Holding agreed to acquire directly or through one of its subsidiaries from each of the HOT Minority Shareholders all of their respective shares in HOT, representing approximately 11% of the outstanding shares of HOT (the “HOT Minority Shareholder Shares”), in consideration for a payment of NIS 41 per share, (ii) each of the HOT Minority Shareholders agreed to waive its Take-Private Consent Right, and (iii) as additional consideration for the waiver of the Take-Private Consent Right, Cool Holding granted each HOT Minority Shareholder the right to purchase the HOT Minority Shareholder Shares from Cool Holding or one of its subsidiaries (the “HOT Minority Shareholder Call Options”) at a price per share equal to NIS 48 (the “Call Consideration”) during the 24-month period commencing on the first anniversary of the Take-Private Transaction. The Take-Private Transaction was completed on December 27, 2012. The HOT Minority Shareholder Call Options may be exercised by the relevant HOT Minority Shareholder in up to three transactions, each of which shall cover at least 30% of the shares sold by such HOT Minority Shareholder to Cool Holding or one of its subsidiaries in the Take-Private Transaction.

The HOT Minority Shareholder Agreements contain anti-dilution rights and consent rights with respect to changes in business prior to the exercise of the HOT Minority Shareholder Call Option and certain minority shareholder rights, which will become applicable if the HOT Minority Shareholder Call Options are exercised after the Take-Private Transaction, including tag-along rights with respect to any sale of HOT shares by Cool Holding; pre-emptive rights with respect to issuance of HOT shares; restrictions on HOT’s ability to effect transactions outside of the ordinary course of business (including a transaction resulting in the sale by HOT of a material asset); subject to certain exceptions, restrictions on entering into transactions with any shareholder, director or officer of HOT or any affiliate thereof; restrictions on the incurrence of any material indebtedness; and, subject to certain exceptions, the right to require HOT to re-register and list its shares on the Tel Aviv Stock Exchange. In addition, Cool Holding has certain drag-along rights with respect to the shares sold to the HOT Minority Shareholders upon the exercise of the HOT Minority Shareholder Call Options.

French Overseas Territories

On July 5, 2013, Altice International, through its wholly owned subsidiary Altice Caribbean consummated the Outremer Transaction. In connection with the Outremer Transaction certain members of Outremer’s management at the time (the “Outremer Minority Shareholders”) received certain equity interests in Altice Blue Two.

In addition, on January 15, 2014, Altice Blue Two completed the Mobius Acquisition. In connection with the Mobius Transaction certain members of Mobius’ management (the “Mobius Managers”) received certain equity interests in Altice S.A. Pursuant to contribution agreements dated January 30, 2014, (i) the Mobius Managers have contributed to Altice S.A. vendors’ notes they hold against Altice Blue Two, against Ordinary Shares of Altice S.A., and (ii) in March 2014, the Outremer Minority Shareholders contributed to Altice S.A. the shares they hold in Altice Blue Two (other than ratchet shares described further below) against Ordinary Shares in Altice S.A. valued at the Offer Price, i.e. €28.25 (the “Managers’ Roll Over). The contribution agreements also contemplate a 2014 financial-performance-based earnout payable to the Outremer Minority Shareholders by way of an additional issue of Ordinary Shares of Altice S.A. in early 2015, up to a value of €10 million. As a result of the above, Altice S.A. issued approximately 2,111,909 new Ordinary Shares subscribed by the Outremer Minority Shareholders and the Mobius Managers, leading to a dilution of Altice S.A. shareholders by approximately 1.0%.

In addition, Altice S.A., the Outremer Minority Shareholders and the Mobius Managers have entered on March 11, 2014, into agreements pursuant to which (i) the Outremer Minority Shareholders transferred ratchet shares tracking the performance of Altice Blue Two to Altice Caribbean, in exchange for warrants issued by Altice Caribbean and tracking the performance of Altice Caribbean and its subsidiaries (together with the underlying shares, the “Altice Caribbean Warrants”), (ii) Altice Caribbean Warrants were awarded to the Mobius Managers, and (iii) existing shareholders’ arrangement at the level of Altice Blue Two were replaced by shareholders arrangements at the level of Altice S.A., Altice Caribbean and Altice Blue Two (the “New Outremer Shareholders’ Arrangements”).

The New Outremer Shareholders’ Arrangements include certain limitations on the rights of the majority shareholders of Altice Caribbean and of Altice Blue Two (but not of Altice), to transfer the shares of the relevant entity and grant liquidity rights to the Outremer Minority Shareholders and the Mobius Managers (collectively referred to below as the “ABT Managers”), including those described below.

At the level of Altice, the New Outremer Shareholders’ Arrangements provide (i) for specific lock-up commitments on the shares held by the ABT Managers in the Company (lapsing partially in 2016 and 2017, and totally in 2018) and (ii) a pre-emption right on those shares in favor of Next L.P. The New Outremer Shareholders’ Arrangements do not provide for specific rights in favor of the ABT Managers relating to the corporate governance of Altice.

At the level of Altice Caribbean, the New Outremer Shareholders’ Arrangements provide certain limitations on Altice Holding’s rights as a majority shareholder of Altice Caribbean, including specific veto and consent rights in favor of the ABT Managers. Further, Mr. Jean Michel Hegeippe (who is one of the ABT Managers), shall be appointed as CEO of Altice Caribbean. The New Shareholders’ Arrangements also contain certain restrictions to the transfer of Altice Caribbean’s shares (including the Altice Caribbean Warrants) and, in particular, (i) an inalienability period lapsing in 2019 on shares held by the ABT Managers (subject to certain exceptions), (ii) the prior approval by Altice Holdings of any transfer of shares of Altice Caribbean held by the ABT Managers, (iii) a pre-emption right in favor of Altice Holdings, (iv) a proportional tag along right in favor of the ABT Managers and (v) a drag along right in favor of Altice Holdings (and, as from 2018, in favor of the ABT Managers) in case of a contemplated transfer of at least 95% of Altice Caribbean’s capital. The New Outremer Shareholders’ Arrangements also provide that all investments of the Altice group in an area covering the Caribbean, the Indian Ocean and Mauritius shall be completed through Altice Caribbean (or one of its subsidiaries). Further, the New Outremer Shareholders’ Arrangements contain put and call arrangements exercisable on the Altice Caribbean Warrants in 2018, at a price determined in order to allow the ABT Managers (subject to certain bad leaver situations) to capture a fraction of the potential value- added to the investment of the Altice group in Altice Caribbean since July 2013 (or, regarding the Mobius Managers), since March 2014.

At the level of Altice Blue Two, the New Outremer Shareholders’ Arrangements provide certain limitations on Altice Caribbean’s rights as a majority shareholder, including specific veto and consent rights in favor of the ABT Managers.

Dominican Republic Acquisitions

Tricom Acquisition Shareholders’ Agreement

Pursuant to an agreement dated October 31, 2013, between Altice Caribbean (a wholly-owned indirect subsidiary of Altice International) and Hispaniola Telecom Holdings, Ltd. (the “Tricom Sellers”), a company controlled by Amzak Capital Management and Inversiones Bahía, (the “Tricom Purchase Agreements”), on March 12, 2014, Altice Caribbean, through one of its subsidiaries purchased all of the outstanding equity interests in each of Tricom S.A. and Global Interlink Ltd. (together, “Tricom”) from the Tricom Sellers (the “Tricom Acquisition”). The aggregate purchase price payable by Altice Caribbean for the Tricom Acquisition was \$405 million. The Tricom Sellers agreed to reinvest approximately \$20 million of proceeds of the Tricom Acquisition in Altice Bahamas, through the subscription of Class B Shares representing 2.8% of the outstanding shares of Altice Bahamas. Furthermore, the Tricom Sellers entered into a shareholders’ agreement with Altice Caribbean which, among other things, included certain restrictions on the transfer of Class B Shares, as well as put and call options on all of the Class B Shares held by the Tricom Sellers, exercisable three, four and five years after the execution of the shareholders’ agreement.

Agreements with Orange in the Dominican Republic

Brand License Agreement

In respect of our use of the “Orange” brand in the Dominican Republic, in November 2013 (in connection with our acquisition of ODO) we entered into a brand license agreement with Orange Brand Services Limited. Under the terms of the agreement, we have a license to use the Orange brand for three to five years effective from the completion of the ODO Acquisition in the Dominican Republic for the current activities of ODO. We currently intend to continue to use the Orange brand and to carry out a rebranding process within approximately eighteen months of acquiring ODO. Royalties under the brand license agreements will be paid to Orange S.A. on a quarterly basis. The brand license

agreement may be terminated by either party in certain circumstances, including if we or Orange Brand Services Limited commit a material breach of the agreement, if we do not satisfy certain minimum investment requirements in the Orange brand, if we undergo certain change of control events or if a competitor purchases shares in us.

It is our intention to negotiate the extension of the Brand License Agreement with Orange Brand Services Limited such as to allow the inclusion of new services to be provided by ODO (and therefore outside the scope of the Brand License Agreement) in the Dominican Republic.

Transitional Services Agreement

Pursuant to the ODO Acquisition, ODO, Altice Dominican Republic II, S.A.S. and Orange S.A. entered into a transitional services agreement (the “Transitional Services Agreement”) on April 9, 2014. The Transitional Services Agreement identified those products and services provided by Orange S.A. (and its related entities) prior to the ODO Acquisition which were to be maintained, modified or terminated, as well as set forth the conditions under which certain products and services were to continue to be provided. Such products and services included, amongst others, intra-group inter-operator roaming services (and related tariffs), the supply of international voice services over VoIP, carrier services, connection services, and back-haul services.

The Transitional Services Agreement automatically terminates twelve months following completion of the ODO Acquisition, unless otherwise agreed by the parties, and as such is valid until April 9, 2015.

Service Agreements in the Dominican Republic

We have entered into agreements with a variety of service and outsourcing suppliers to conduct our ongoing business. These services include supply of software licenses, call center support, data management and human resources consulting, among others. Certain of these agreements terminated upon the consummation of the ODO Acquisition due to change of control clauses included therein, as a result of which we switched suppliers or have entered into negotiations for renewal. Our service agreements with TechComm and Transunion S.A. did not contain a change in control but both required us to notify TechComm and Transunion S.A., respectively, in the event of a change of control in our corporate structure. On the consummation of the ODO Acquisition we successfully notified TechComm and Transunion S.A. of the change in our control and both parties have continued their respective performance under each contract.

Supply Agreements in the Dominican Republic

Following the completion of the ODO Acquisition, the supply agreements entered into by Orange S.A., on our behalf, with Alcatel, Apple Gemalto, Huawei, Motorola, LG, Nokia, Oberthur, RIM, Samsung, Sony Ericsson and ZTE for the supply of handset devices have. We are currently working to establish new centralized sourcing agreements for all vendors. We are still in the early stages of negotiations, and in the meantime we are working on individual purchase order basis until new contracts are agreed.

MVNO Agreements

In Belgium, we offer mobile telephony services to our customers as MVNO operators. Our MVNO agreement with Mobistar is valid for an initial term of three years expiring at the end of December 2014. We have entered into an MVNO agreement with BASE to provide us with MVNO services as from the date of the expiry of the Mobistar agreement. The term of the agreement is for three years, with it being valid until December 2017.

Seasonality

Although our businesses are not subject to significant seasonal effects, revenue from our pay television, broadband internet access and fixed-line telephony operations tend to be slightly higher in the fourth quarter of the year and slightly lower in the third quarter of the year.

Intellectual Property

We use a variety of trade names and trademarks in our business, including “HOT” in Israel, “Numericable” and “Coditel” in Belgium and Luxembourg, “Numericable” and “ONLY” in the French Overseas Territories, “Cabovisão” and “ONI” in Portugal, “Orange” and “Tricom” in the Dominican Republic and, in each case, several associated trademarks. We use the “Numericable” brand, a trade mark belonging to Numericable France, in Belgium, Luxembourg and the French Overseas Territories, pursuant to a trademark licensing agreement. Other than “Numericable” and certain associated trademarks, we own all of the trademarks we use. All of our trademarks are protected in the jurisdictions in

which we operate. We license the “Altice” brand from our founder and executive chairman Patrick Drahi for a nominal annual fee.

In respect of our use of the “Orange” brand in the Dominican Republic, in November 2013 (in connection with our acquisition of ODO) we entered into a brand license agreement with Orange Brand Services Limited that has now become effective as of the completion of the ODO Acquisition. Under the terms of the agreement, we have a license to use the Orange brand for three to five years effective after the closing of the ODO Acquisition in the Dominican Republic for the current activities of ODO. We currently intend to continue to use the Orange brand and to carry out a rebranding process within approximately eighteen months of the acquisition date. Royalties under the brand license agreements will be paid to Orange S.A. on a quarterly basis. The brand license agreement may be terminated by either party in certain circumstances, including if we or Orange Brand Services Limited commit a material breach of the agreement, if we do not satisfy certain minimum investment requirements in the Orange brand, if we undergo certain change of control events or if a competitor purchases shares in us.

We do not possess any material patents, nor do we believe that patents play a material role in our business.

We license some of the television programming content for our pay television offering from third-party providers. In addition, in Israel, we co-develop shows and have also developed several show platforms for our “HOT” suite of channels. Further, we have acquired Ma Chaîne Sport and SportV, French and Luxembourg producers of sports-themed pay television content which they distribute via their television channels. We own the copyright that subsists in the content developed or co-developed by us.

Employees

The following tables show our employees by country of employment.

	As of September 30, 2014	As of December 31, 2013	As of December 31, 2012	As of December 31, 2011
Israel.....	2,372	2,677	5,121	5,814
Belgium and Luxembourg.....	70	70	82	83
Portugal.....	465	491	561	719
Switzerland.....	99	87	81	81
French Overseas Territories.....	998	930	830	910
Dominican Republic.....	2,111	3,078	3,078	2,838
Total	6,115	7,333	9,735	10,445

Certain of our subsidiaries also use contract and temporary employees, which are not included in the above number, for various projects.

We are subject to various labor laws in each of the jurisdictions in which we operate. Labor laws typically govern the length of the workday, minimum wages for employees, procedures for hiring and dismissing employees, determination of severance pay, annual leave, sick days, advance notice of termination of employment, equal opportunity and anti-discrimination laws and other conditions of employment. Further, we are generally required to provide severance pay upon the retirement, death or dismissal of an employee. We are also required to make national insurance payments on behalf of our employees to the government in each of the jurisdictions in which we operate.

Some of our employees currently belong to organized unions and works councils. In Israel in August 2013, Power to the Workers, a democratic workers organization, claimed a collective dispute and requested declaratory reliefs that Power to the Workers is the representative organization of HOT (not including HOT Mobile), and that the group must conduct negotiations regarding a collective bargaining agreement. On September 11, 2014 the labor tribunal gave its verdict, ruling that Power to the Workers did not sign the minimum number of employees required by law (33.3%) in order to become a representative workers organization in HOT (either including or excluding HOT Mobile).

On September 23, 2014, the Regional Labor Court in Tel Aviv ruled that the relevant entity for negotiation with respect to the Collective Agreements Law, 5717-1957 (the “Collective Agreements Law”) is HOT Mobile and that the representative organization is the New General Histadrut of Employees (the “General Histadrut”). It was further determined that HOT Mobile breached the provisions of the Collective Agreements Law in a series of actions that were intended to harm its employees’ freedom of assembly, and HOT Mobile was ordered to pay compensation of NIS 1 million to the General Histadrut. HOT Mobile has filed an appeal of this judgment to the National Labor Court.

On October 29, 2014, the National Labor Court dismissed, by consent of the parties, the motions filed by the General Histadrut and Power to the Workers, seeking to prevent HOT Mobile from entering into negotiations regarding a

collective agreement with the General Histadrut, after HOT Mobile gave notice that it recognized the General Histadrut as a representative organization.

Other than as disclosed in these Listing Particulars, we consider our employee relations to be good.

Properties

We lease and own certain properties for our corporate offices, sales offices, broadcast centers, communication rooms, customer service centers, sales stores, mobile network sites, hubs, switches and head-end sites. Our registered office is located at 3, boulevard Royal, L-2449 Luxembourg. With respect to our Israeli operations, our main corporate offices are located in Yakum which is located in proximity to Tel Aviv. With respect to our Belgian operations, our main corporate offices are located in Brussels, Belgium. With respect to our Luxembourg operations, our main corporate offices are located in Strassen, Luxembourg. With respect to our Portuguese operations, our main corporate offices are located in Lisbon, Portugal and Palmela, Portugal. With respect to our operations in the French Overseas Territories, our main corporate offices are located in Paris, France. With respect to our operations in the Dominican Republic, our main corporate offices are located in Santo Domingo.

We believe that our properties meet our present needs and are generally well-maintained and suitable for their intended use. We believe that we generally have sufficient space to conduct our operations but maintain flexibility to move certain operations to alternative premises.

Environmental Matters

We are subject to a variety of laws and regulations relating to land use, environmental protection and health and safety in connection with our ownership of real property and other operations, including laws regulating non-ionic radiations emitted as a result of our mobile services. While we could incur costs, such as clean-up costs, fines and third party claims for property damage or personal injury, as a result of violations of or liabilities under such laws or regulations, we believe we substantially comply with the applicable requirements of such laws and regulations and follow standardized procedures to manage environmental risks. Given our activities and our current property, plant and equipment, we believe that there are no environmental factors likely to have a significant impact on the use of our current property, plant and equipment, other than as disclosed in these Listing Particulars in *“Risk Factors—Risks Relating to Our Business, Technology and Competition—Our business may be adversely affected by actual or perceived health risks and other environmental requirements relating to exposure to electromagnetic fields through telecommunications equipment”*.

Furthermore, we are also careful to offer our subscribers ecologically responsible products and services in order to reduce their energy consumption. Due to its versatility and multifunctionality, the LaBox represents a significant advance, since it combines several functions (Blu-Ray TM reader, TV-HD decoder and removable hard drive).

Insurance

We maintain a property insurance policy with wide coverage based on “extended fire” wording to cover our property on a new replacement basis. In certain of our geographies, including Israel, we also maintain a business interruption policy based upon the same perils. The property coverage is supported by coverage for electronic equipment. We maintain various liability insurance policies including general liability, comprehensive third-party liability, products liability and professional liability, multimedia liability and employer’s liability insurance policies. In addition to these policies we maintain motor vehicle insurance policies, heavy equipment policy, open policy for contract works to cover maintenance and development works and few other small policies. We have directors’ and officers’ liability insurance policies that cover all members of our Group executive management and the members of the majority of our local management boards. We do not insure against certain operational risks for which insurance is unavailable or which can only be insured at what we believe to be on unreasonable terms.

In our view, the sum insured, the limits of liability, the deductibles and scope of cover in our policies are satisfactory and suitable for companies acting in the telecommunications sector (subject to the wording of the policies, conditions and exclusions). However, we cannot guarantee that no losses will be incurred or that no claims will be filed against us which go beyond the type and scope of the existing insurance coverage. With respect to the majority of our businesses, we do not insure against war and terrorism risks, but we believe we are covered in Israel by the Property Tax and Compensation Fund Law 1961.

Legal Proceedings

We are involved in a number of legal and administrative proceedings arising in the ordinary course of our business. The legal proceedings initiated against us include, amongst others, the following categories of claims: claims by or on behalf of customers on various grounds such as alleged misrepresentation or breach of service or license terms or breach of

telecommunication, broadcasting, consumer or health and safety regulations, intellectual property claims primarily relating to alleged copyright infringement brought by copyright collection societies, claims by suppliers and other telecommunications providers, claims by employees and claims by the regulatory bodies whose jurisdiction we are subject to in the countries in which we operate. In Israel, a majority of legal proceedings against us are suits seeking certification as class action suits. The Israeli Class Action Law that was enacted in 2006 significantly expanded the grounds for certification of class action suits as well as the persons entitled to submit a class action suit as a result of which the number of such proceedings against us has increased significantly and may continue to increase in the future.

We proactively manage our litigation risks by assessing disputes where we believe the claimant may have merit and attempting to settle such disputes on favorable terms, including in the case of suits seeking certification as class action suits at a stage prior to such certification, and contesting others where we believe the claim does not have merit. We record a provision when there is a sufficient probability that a dispute will result in a loss for the Group and the amount of such a loss can be reasonably estimated. Other than as discussed below, as of the date of these Listing Particulars, we are not aware of any administrative, judicial or arbitral proceedings (including any pending or threatened proceedings) that are likely to have, or have had, over the course of the last twelve months a material adverse effect on our financial condition or results of operations. The outcome of legal proceedings, however, can be extremely difficult to predict with certainty, and we can offer no assurances in this regard.

Information relating to the provisions of the Group with regards to legal proceedings can be found under Note 13.1.1 of the unaudited condensed consolidated financial statements of Altice International as of and for the nine month period ended September 30, 2014, and Note 14 of the audited consolidated financial statements of Altice International as of and for the year ended December 31, 2013.

Litigation Relating to Coditel Network in Luxembourg

In 2006 and 2010, respectively, the municipalities of Roeser and Junglinster in Luxembourg terminated Coditel's network operation agreements. Coditel refused to comply with the municipalities' request to stop operating the network as it deemed that Coditel acquired ownership of the network from a private individual prior to entering into the agreements with the municipalities, which only pertain to the network operations, and that such authorization is no longer required since the implementation of the telecommunication package in Luxembourg. The municipalities of Roeser and Junglinster each sued Coditel, claimed ownership of the network and demanded that Coditel cease network operations. In December 2012, the District Court of Luxembourg (First Instance) ruled, in each case, that Coditel should cease operations within three months subject to a daily €100 fine. The court also ruled that Coditel is the owner of the network in Roeser. The court did not order provisional enforcement of the proceedings. In February 2013, Coditel filed an appeal against the decision rendered by the Court of Luxembourg. The proceedings are still pending.

Coditel is involved in a number of other legal proceedings in the ordinary course of its business.

Certain class action suits in Israel

In March 2010, a suit seeking certification as a class action was filed against HOT in the Central District Court regarding an alleged breach of provisions of the Communications Law regarding the disconnection of subscribers from its services. The applicant has claimed damages of NIS 105 million. As of the date of these Listing Particulars, a settlement agreement including a contribution to the community valued at NIS 7.5 million and certain benefits to subscribers was filed to the Central District Court but has been denied by the Central District Court. A motion to appeal on the same decision was filed to the Supreme Court. On September 1, 2013, the Court decided to appoint an auditor to examine the settlement agreement. The auditor recommended approval of the settlement agreement, subject to certain changes, and, in July 2014, HOT and the plaintiff submitted an amended agreement in accordance with the auditor's recommendations. The Israeli Attorney General filed an objection to the amended agreement, and HOT intends to submit its response to the Government's position. The matter is still pending.

In October 2010, a suit seeking certification as a class action was filed against HOT in the Central District Court relating to alleged breach of HOT's Broadcasting License and certain provisions of its agreements with subscribers when collecting subscribers' fees in respect of the month in which the company's services were provided to subscribers, rather than charging the following month. The applicant has estimated damages in the suit of NIS 433 million. In June 2014, the Central District Court denied the suit and the motion to approve it as class action. In September 2014, the applicant filed a motion to the Supreme Court to extend the date to file an appeal on the case and to replace the plaintiff. The matter is still pending.

On December 11, 2011, HOT received a claim and request to certify a class action filed with the Central District Court. The applicant claims that HOT violated its license and was unjustly enriched because it collected from subscribers "handling fees" in connection with the collection of debts higher than allowed by law. The Applicant asked the court to approve the class action and to rule in favor of the group in which the reliefs sought, including compensation totaling NIS

27.3 million or any other amount at the discretion of the Court. On September 2, 2012, the Court filed its reply to the request and on October 22, 2012, held a preliminary hearing request, and stated that there is no need to process evidence and that the parties submit their summations. The matter is still pending.

In February 2011, a suit seeking certification as a class action was filed against HOT by two applicants to the Central District Court, relating to alleged breaches of certain subscribers' agreements by increasing the price of services to subscribers, including alleged misleading of subscribers when increasing the prices of services. The applicants estimated damages in the suit of NIS 666 million. Following preliminary proceedings, on January 14, 2013, the Court decided that the hearing of the case will be delayed until a decision is reached with regards to the class action which was filed on December 11, 2011, as detailed above.

In March 2012, a suit seeking certification as a class action was filed against HOT to the Haifa District Court. The applicant claims, *inter alia*, that HOT acted unlawfully when it did not pay CPI linkage differentials and interest to disconnecting subscribers with respect to the period beginning on the disconnection date until the refund date. The applicants estimate damages of approximately NIS 112.4 million. The matter is still pending.

In April 2012, a suit seeking certification as a class action was filed against HOT and against HOT Telecom in the Tel Aviv District Court regarding alleged breach of certain provisions of the law regarding the supply of frontal services. The applicant has claimed damages in the suit of NIS 186 million. On January 16, 2014, the Court was asked to approve the settlement agreement. The matter is still pending.

In November 2012, a purported shareholder of HOT filed a suit seeking certification as a class action against Cool Holding, the HOT Minority Shareholders, HOT and members of its board of directors in the Economic Division of the Tel Aviv District Court. The suit claims that, among other things, the consideration for the Take-Private Transaction has been allocated in a manner that prejudices the public shareholders of HOT, by providing the HOT Minority Shareholders with consideration in excess of the consideration received by the other public shareholders and that certain conflicts of interest existed. The suit calls for the parties other than HOT to reallocate the consideration, in a manner that would result in the public shareholders (other than the HOT Minority Shareholders) whose shares of HOT will be acquired in the Take- Private Transaction receiving an additional aggregate amount in excess of NIS 54 million. A similar claim, also seeking certification as a class action, was filed on behalf of another purported shareholder on November 26, 2012, challenging the allocation of consideration in the Take-Private Transaction, alleging that the share price in the transaction was unfair and asking the court to appoint an expert to determine a fair price. This claim sought total damages of up to NIS 195 million. In December 2014, HOT approved a settlement agreement with the plaintiffs in the aforementioned class actions. The settlement agreement, which was approved by the Audit Committee and the Board of Directors as fair and reasonable under the circumstances, states that against full and final waiver and dismissal of the claim, the plaintiffs will be paid an amount of NIS 2 (including legal fees and VAT) for every share that was purchased in the merger agreement, that one plaintiff will be refunded part of the VAT applicable to it and that both plaintiffs' legal fees will be paid. The total amount of the settlement is approximately NIS 30 Million. The Company and the controlling shareholder will share the settlement equally without admitting or agreeing with any allegation raised by the plaintiffs in their legal statements. The terms of the final settlement agreement remain subject to Court approval.

In November 2013, a class action suit was filed against HOT and certain other telecommunications operators by Roli Kleiman and certain others, alleging breach by HOT and the other defendants of certain Israeli laws including the Equality Law, the Regulations of Equality for People with Disabilities, the Torts Ordinance and the Consumer Protection Law by failing to provide cellular or stationary phone devices and/or services suitable for people with disabilities. The plaintiffs are representing all people with disabilities who were customers of HOT and the other defendants during the period at issue. The compensation being sought from HOT is NIS 97 million. The proceedings are still pending.

In November 2013, HOT received notice of an application for a class action suit, whereby the applicant is seeking to represent every customer who received telephone calls from HOT representatives that amounted to harassment during the 7-year period preceding the date of the claim. According to the applicant, HOT's sales representatives harass potential customers through the volume of telephone calls it places, which allegedly resulted in a breach of HOT's obligation stipulated in the Communications Act (Telecommunications & Transmissions), 5742-1982. The applicant is also claiming invasion of privacy and a breach by HOT of its good faith duty at the pre-contract stage. The applicant estimates the damage to each member of the class action suit to be no less than NIS 250. In addition, the applicant has requested an injunction, prohibiting HOT from continuing to make telephone calls that amount as harassment. HOT is studying the details of the claim and application for a class action. The matter is currently in its preliminary stages.

On December 12, 2013, HOT received notice of an application for a class action suit, filed by two of its customers ("the application" and "the applicants", respectively) in the Tel Aviv District Court. The applicants wish to represent all of HOT's customers who do not benefit from the monthly discount on VOD services ("the monthly television discount") or a discount on certain channels. According to the applicants, HOT offers various benefits selectively to some of its customers, in order to retain them or incentivize them to subscribe to more of its services, contrary to HOT's obligation

pursuant to the provisions of the license for cable broadcasts granted to HOT, to offer its services on equal and non-discriminatory terms. In addition, the applicants allege that HOT is misleading its customers regarding the accepted price by not revealing the existence of the aforesaid benefits. The amount of the claim is NIS 100 million. The applicants are seeking to obtain a declarative junction. The matter is still pending, and HOT is studying the details of the claim and the application for this class action suit.

On January 16, 2014, HOT received notice of a claim filed in the Jerusalem District Court by B-Point Systems Ltd against HOT, HOT Telecom, HOT Net, Tel Aviv Telecom Ltd and their respective officers and controlling shareholders. According to B-Point Systems Ltd, under an agreement to supply HOT and its associated companies with installation and maintenance services, HOT, its associated companies and its and their respective officers breached the agreement by acting in bad faith and negligently, and unlawfully enriching themselves. The amount of the claim was estimated at approximately NIS 45 million. Pursuant to such claim being filed, both parties agreed to resolve the matter through mediation which has not yet taken place.

On June 10, 2014, HOT received a claim, and a motion to approve it as a class action, filed by a customer of HOT at the District Court in Tel Aviv. The plaintiff claims that amplification systems installed by HOT and HOT Telecom in condominiums were connected to the building's electrical system, and therefore all residents of these buildings, including those who are not customers of HOT or HOT Telecom, bear the cost of the electricity consumed by these amplification systems. The plaintiff alleges causes of action in contracts law, unjust enrichment and breach of HOT's and HOT Telecom's licenses. The entire claim is estimated by the plaintiff to be NIS 285 million. The matter is still pending.

On October 7, 2014, HOT Mobile received a claim, and a motion to approve it as a class action, filed by customers of HOT Mobile at the District Court in Tel Aviv. The plaintiffs claim that on September 28, 2014, HOT Mobile did not provide a necessary time synchronization service for its cellular devices, and failed to update devices to "winter" time at the necessary time. They claim that HOT Mobile should have prepared in advance for the synchronization and repair the system defect and/or notified them in advance regarding the possibility of the occurrence of the failure. The plaintiffs allege causes of action in contracts law, tort, unjust enrichment and breach of legal obligation under the Consumer Protection Act. The plaintiffs estimate that each of the group members suffered damage of an average of NIS 500. The group includes half of the company's customers. The entire claim is estimated by the plaintiffs to be NIS 175 million. HOT Mobile is studying the details of the claim and the motion.

On December 18, 2014, HOT received a claim, and motion to approve it as a class action, filed against it in the District Court in Tel Aviv. The plaintiffs allege that HOT breached its statutory obligations, its duty of good faith and contractual faithfulness and has been unlawfully enriched at consumers' expense by linking the price of its services to subscribers to CPI and increasing costs accordingly. The plaintiffs include all those who have been charged by linkage to CPI in monthly invoices during the last seven years and claim damages totaling NIS 70 million plus linkage and interest payments. HOT is studying the details of the claim and the motion.

Dominican Republic Legal Proceedings

On October 1, 2013, Servicio Ampliado de Teléfonos, C. por A. ("Satel") filed a complaint for damages against ODO in the Dominican Republic, claiming violation by ODO of Satel's spectrum entitlements relating to frequencies 941960Mhz and an alleged violation of articles 105, 103 of Law 153 98 and Article 47 of General Regulation of Use of the Radioelectric Spectrum No. 128 04. Satel sought \$298 million DOP in damages from ODO, however, on October 23, 2013, Satel voluntarily withdrew its claim and filed it again for \$373 million DOP in December 2013. A settlement was reached among the parties and executed on April 8, 2014. On October 8, 2014, Satel and ODO entered into an Assignment Agreement in favor of Fundacion Prodigio, a trust set in favor of Satel, Juan Ramon Gomez Diaz and Corporacion Rafa for purpose of executing a first payment.

The payments relating to the abovementioned settlement in favor of Fundacion Prodigio will be triggered after execution of an amendment to the assignment agreement the purpose of which is to reflect tax obligations of Satel and Juan Ramon Gomez Diaz. The schedules of payments is to pay 42% of the settlement consideration to Prodigio once the amendment is executed. The remaining 58% (minus the tax obligations owed by Satel and Juan Ramon Gomez Diaz) are owed once the conditions precedents set forth in the settlement agreement are satisfied. We are currently in the process of negotiating the amendment to the assignment agreement.

DESCRIPTION OF PT PORTUGAL'S BUSINESS

In this section, references to “we”, “us” and “our” refers to PT Portugal and its subsidiaries.

Overview

We are the largest telecommunications service provider in Portugal. Our operations are mainly conducted through two key subsidiaries: PT Comunicações, S.A. (“PTC”) (which generated €1,765.8 million of revenues on a standalone basis, the contribution of which, after intercompany eliminations, represents 60.7% of our *pro forma* combined revenues in the year ended December 31, 2013) and Meo, Serviços de Comunicações e Multimédia, S.A. (“Meo, S.A.”) (which generated €1,064.3 million of revenues on a standalone basis, the contribution of which, after intercompany eliminations, represents 36.4% of our *pro forma* combined revenues in the year ended December 31, 2013). PTC provides fixed line services, Pay-TV services (through IPTV, FTTH and DTH platforms), ISP services to residential customers and small and medium size companies (“SMEs”) and small office/home office (“SOHOs”), as well as data transmission services and is also an ISP for large commercial clients. Meo, S.A. provides mobile services under a GSM license, a UMTS license, and a fourth generation mobile license (“4G license”) through the Long Term Evolution (“LTE”) technology.

We manage our business along customer segments with cross-functional collaboration to deliver the best customer experience. We provide telecommunication services in the following customer categories:

- *Residential services*, which are mainly provided by PTC and include integrated networks inside the customer’s home enabling the simultaneous connection of multiple devices, including fixed line telephones, TVs (including Internet Protocol Television and direct-to-home satellite Pay-TV services), game consoles, PCs, laptops, tablets and smartphones.
- *Personal services*, which are provided by Meo, S.A. and include mobile telecommunications services, including voice, data and internet- related multi-media services across several access devices, such as mobile phones, smartphones and tablets, as well as wireless datacards and dongles (devices that attach to the USB port of a laptop/computer to provide mobile broadband service) for internet access.
- *Enterprise services*, which are provided by PTC and Meo, S.A. include Corporate and SME/SoHo services, which provide our corporate and medium and small business customers with data and business solutions, as well as IT/IS and business process outsourcing (BPO) services:
 - *Corporate services*, which targets large companies and provides data, internet, video and voice communications, services, fixed-mobile convergence solutions and selected information technology services, network managing and outsourcing; and
 - *SME/SoHo services*, which targets (i) SMEs, providing vertical data and business solutions that are similar to our corporate services and (ii) SOHOs, customers and provides cost-effective data and business solutions for those working in small businesses or at home.
- *Wholesale and other services*, which are essentially provided by PTC, and primarily include wholesale telecommunications services to other telecommunications operators, public pay telephones, the production and distribution of telephone directories and other services in Portugal.

For the year ended December 31, 2013, we had over 12.6 million RGUs, and our *pro forma* combined operating revenues and EBITDA were €2,627.4 million and €1,026.4 million, respectively. For the nine months ended September 30, 2014, we had over 13.1 million RGUs, and our *pro forma* combined operating revenues and EBITDA were €1,900.9 million and €746.6 million, respectively.

History

PT Portugal was incorporated by Portugal Telecom SGPS, S.A. in March 2006 as part of a corporate reorganization of the Portugal Telecom group’s businesses into geographic areas. In connection with this reorganization, in September 2006, PT Portugal subsequently acquired the investments in PTC and Meo, S.A., which were previously held by Portugal Telecom. In 2009, Portugal Telecom continued the reorganization of its group by geography by transferring to PT Portugal the Portuguese support companies (which render services mainly to PTC and Meo, S.A.), in order to improve the corporate structure and obtain efficiency gains in the businesses managed by PT Portugal. In connection with this 2009 reorganization, PT Portugal acquired the investments in PT Cloud e Data Centers, S.A. (“PT Cloud e Data Centers”), PT Inovação e Sistemas, S.A. (“PT Inovação”), PT Pro—Serviços Administrativos e de Gestão Partilhados, S.A. (“PT Pro”), PT Sales—Serviços de Telecomunicações e Sistemas de Informação, S.A. (“PT Sales”) and

PT Contact—Telemarketing e Serviços de Informação, S.A. (“PT Contact”), which were previously held by Portugal Telecom.

PTC renders fixed line services, initially under the provisions of the Concession Contract entered into with the Portuguese State on March 20, 1995, in accordance with Decree Law 40/95, for an initial period of thirty years, subject to renewal for subsequent periods of 15 years. On December 11, 2002, according to the terms of the Modifying Agreement to the Concession Contract, PTC acquired the property of the Basic Network of Telecommunications and Telex (“Basic Network”). Both these contracts were revoked by the Decree Law 35/2014 of March 7, 2014, effective as of June 1, 2014. On May 9, 2014, ANACOM issued to PTC a declaration that allows PTC to continue providing those fixed line services. PTC also renders Pay-TV services, through IPTV, FTTH and DTH platforms and Internet Service Provider (“ISP”) services to residential and small and medium size companies, as well as data transmission services and is also an ISP for large clients.

Meo, S.A. renders mobile services under a GSM license granted by the Portuguese State in 1992 for an initial period of 15 years, which was renewed in 2007 until March 16, 2022, and a UMTS license obtained on December 19, 2000 for an initial period of 15 years, renewable for an additional period of another 15 years. In March 2012, Meo, S.A. acquired a fourth generation mobile license (“4G license”), under which it provides services as from 2012 through the Long Term Evolution (“LTE”) technology, which represents an evolution from the GSM technology that allows for higher levels of bandwidth and speed. This license has an initial period of 15 years, renewable for an additional period of another 15 years.

In January 2013, PT Portugal launched the first quadruple play offer, through the brand name *M4O*, representing a fixed-mobile convergent service, including television, internet, and fixed and mobile telephone services.

On May 5, 2014, Portugal Telecom subscribed to a share capital increase at Oi, S.A. through the contribution in kind of its 100% interest in PT Portugal and, as a result, PT Portugal is since a wholly-owned subsidiary of Oi, S.A.

Our Services

Primarily through PTC and Meo, S.A., we offer our services to each of four customer segments: residential services, personal services, enterprise services, and wholesale and other services.

Residential

Our residential services, which are mainly provided by PTC, focus on offering customers (both fiber and satellite) a differentiated TV experience, which capitalizes on the increased capacity of our new generation access network. We provide integrated networks inside the customer’s home, anchored on premium content and a multi-screen strategy which enables simultaneous and seamless access to content on multiple devices (including PCs, TVs and smartphones). Our triple-play service, *Meo*, offers a differentiated customer experience through (i) a non-linear experience with video-on-demand, pause and restart-TV, (ii) a complete ecosystem for TV apps (Facebook, games, music, Kids and Sapo), (iii) interactive features providing additional depth over key channels and contents, and (iv) user generated content with *Meo Kanal*, an application that allows users to produce, edit and share multimedia user content on television with other *Meo* customers that created the first network effect on TV. We also successfully launched a quadruple-play service, *M4O*, which offers Pay-TV, broadband internet, fixed telephone and mobile telephone services. Our television services and fixed line services are further described below.

Pay-TV Services

Our television strategy is based on a multiplatform concept that aims to provide similar content and user experiences across television, PCs and mobile phones. Launched in 2008, *Meo* is our TV brand across the various platforms, primarily at home (through IPTV and satellite), through mobile telephones (through *Meo Go! Mobile*) or through personal computers (through *Meo Go!*). *Meo* provides access to a comprehensive content offering, with more than 160 TV channels and thousands of video-on-demand titles. We offer tiered packages of channels, as well as on-demand availability that can be subscribed for, in real time, directly through the TV set. *Meo* also provides access to advanced features, such as digital recording and pause live-TV. The set-top boxes in the *Meo* service are all HD-compliant, using MPEG4. We were the first operator in Portugal to introduce HDTV and have the most extensive video-on-demand offer in the market. As of December 31, 2013, *Meo* had 1.3 million customers and a 41.5% market share, according to ANACOM.

In January 2013, we announced the launch of a quadruple-play offer of converged fixed-mobile services by *Meo*, which includes TV, internet, fixed telephone and mobile telephone services under the brand *M4O*. We designed this product after studying recent trends in the Portuguese market, which revealed rising consumer preference for quadruple-play services all reflected on the same invoice, a desire to include the entire family in a single plan, and the importance of

high-quality connectivity to the internet. *M4O* offers 120 TV channels, 100 Mbps broadband speed, unlimited calls and two to four mobile SIM cards, including free of charge calls and text messages to all wireline and wireless networks, using our 3G and 4G networks. The launch of *M4O* enabled us to reach a household penetration of 1.7 million RGUs and to promote customer migration from prepaid to post-paid by approximately 190 thousand customers.

Meo continues to innovate and, in the first quarter of 2013, added a new exclusive channel, *Correio da Manhã TV*, in partnership with Cofina, the owner of several newspapers and magazines in Portugal, including *Correio da Manhã*. These channels are available on several platforms, including PCs, smartphones and tablets, through the *Meo GO!* service. *Meo*'s content offering also includes thousands of video-on-demand titles and includes interactivity based on anchor programs (e.g. *Idols*, *Secret Story*, *Biggest Loser*). With respect to content, we continue to focus on the intensification of partnerships with content providers, on two-way collaborations to improve content quality, and on the renegotiation of existing content deals aimed at further adapting the content cost structure to the current environment and thereby generating savings in content costs.

Meo also offers advanced interactive applications accessed through the remote control and covering multiple categories, such as (i) News, including a personalized newscast app, developed in partnership with RTP, the state-owned free-to-air channel, and the *Sapo Kiosk* application featuring the daily covers of all local and several international newspapers and magazines, (ii) Sports, including a soccer app, a surf app and specific sports channel applications, such as the *BenficaTV* app and the *SportTV* app, (iii) Music, including *MusicBox*, a multiscreen music streaming service, *Meo Radios*, a radio streaming app, and *Meo Karaoke*, an application that offers *Meo* customers the ability to subscribe and sing from a wide catalog of local and international hits, (iv) Kids, including a comprehensive children's portal where kids can access video-on-demand content, music clips, karaoke, games and tailored educational content, (v) Convenience, including apps for weather, traffic and pharmacies and (vi) Personal content, including an online photo storage app. In 2012, *Meo* launched eight new apps of this type, including *Sapo Voucher*, the first interactive TV app allowing financial transactions and interactions with TV advertisements.

In line with our strategy for content differentiation through interactivity that *Meo* has been pursuing since its launch, we initiated two new "red button" interactive applications in the third quarter of 2013, linked to two popular TV programs in Portugal: (i) "X Factor," developed in partnership with SIC, and (ii) "I love it", a youth TV series, developed in partnership with TVI. Leveraging the fourth edition of "Secret Story," a reality show on TVI, *Meo* launched an exclusive Secret Story channel in late September 2013, airing live 24 hours a day from the Secret Story house, with an interactive application that allowed customers to select the camera from which they wanted to follow contestants in the show and delivered exclusive content.

In January 2013, *Meo* also launched *Gravações Automáticas*, a recording feature that allows customers to record programs and access those recordings up to seven days after the programs were broadcast. We have also developed new and innovative interactive solutions, such as *Meo Energy*, a service for monitoring home energy consumption, which includes rate recommendations based on one's actual consumption profile and suggestions on how to lower a consumer's energy bill.

Fixed Line Services

We had approximately 3,892 thousand fixed retail accesses in service as of December 31, 2013, excluding external supplementary lines, direct extensions and active multiple numbers. Within retail accesses, we track and report:

- traffic-generating lines held by subscribing customers;
- carrier pre-selection lines, which are lines of competitors for which those customers have elected to use our services;
- fixed broadband retail lines; and
- IPTV, FTTH and DTH customers using our *Meo Pay-TV* services.

As of September 30, 2014, we are able to reach 2.1 million homes in Portugal with our FTTH network, after giving effect to the fiber sharing agreement with Vodafone (which is further described below under "*Material Contracts—Fiber Sharing Agreement with Vodafone Portugal*"). Our network, which is developed in urban areas, is a strategic investment to improve our competitiveness among residential customers, where we can offer distinctive Pay-TV and bundled offers.

Over the last decade, total traffic on our fixed line network has decreased, primarily because consumers have increasingly used mobile services instead of fixed line services and because of the migration of dial-up internet users to Asymmetric Digital Subscriber Lines ("ADSL"). The number of active mobile cards (the mobile equivalent of main lines) exceeds the number of fixed line main lines in Portugal. We have responded to this trend by encouraging the use of our fixed line

network for bundled services, including triple-play packages that include fixed-line telephone services, broadband internet access and Pay-TV services.

Additionally, we are required to provide carrier selection to our customers for all kinds of traffic. See “*Regulatory—Portugal—Areas of Recent Regulation and Updates—Number Portability and Carrier Selection.*” Carrier selection has been an additional factor that has contributed to the reduction in traffic on our network.

Personal

Through Meo, S.A. in our personal services customer segment, we offer a range of products and services, including (i) a variety of voice and data tariff plans, both prepaid and post-paid, designed to integrate unlimited voice and data plans targeted at high-value post-paid customers and, in the prepaid market, to discourage migration to low-value tariff plans by offering additional voice and data services; (ii) a portfolio of approximately 50 smartphones, including exclusive handsets, with the capability to use an array of value-added and convergent services (mobile TV, music on demand, navigation app, social network aggregator, cloud storage, etc.); and (iii) mobile broadband offers of up to 150 Mbps speed, using 4G technology and offering free access to our national Wi-Fi network. We were the first operator in the world to offer prepaid services, and our prepaid and discount products remain popular. As of December 31, 2013 approximately 75.4% of our subscribers were using prepaid products.

We launched a 4G offering in 2012, and we continuously invest in new services. Our 4G offering currently allows (i) speeds of up to 150 Mbps; (ii) access to live TV channels through Meo Go!, a service that allows access to live TV channels on PCs, tablets and smartphones; (iii) a music streaming service through *Meo Music*, a multiplatform music streaming service, providing access to a catalog of millions of music tracks, which recently underwent a platform upgrade, (iv) *Multi-SIM*, for sharing of traffic among various devices, including PCs, through wireless dongles, tablets and smartphones and (v) *Meo Drive*, a navigation app available in iOS and Android Marketplaces.

At its launch in March 2012, our 4G service was available to 20% of the Portuguese population and was expanded to 93% of the population by the end of 2013. We market our 4G mobile broadband services through *Meo’s 4G* and *Meo 4G* brands. These offerings range in speed from 50 Mbps to 150 Mbps, with monthly retail prices starting €34.99 (with discounts for early subscribers under a month loyalty program) and include *Meo Music* for free. *Meo 4G* or *Meo 4G* customers that are also *Meo* customers have free access to more than 60 live TV channels through the *Meo Go* service.

In January 2013, following the launch of the *M4O* quadruple-play offering, *Meo* repositioned its voice and data tariff plans. In the post-paid category, unlimited plans now have four different price points, or sizes: (i) the *unlimited S*, for €15.9 per month, offers 600 MB of mobile internet (*internetnotelemovel*), unlimited Wi-Fi access plus 100 minutes or SMS on all other networks; (ii) the *unlimited M*, for €29.90 per month, offers 1 Gb of mobile internet, unlimited Wi-Fi access plus unlimited voice and SMS, and 120 minutes or SMS on all other networks; (iii) the *unlimited L*, for €39.90 per month, offers 1 Gb of mobile internet and unlimited Wi-Fi plus unlimited voice and SMS on all other networks; and (iv) the *unlimited XL*, for €69.90 per month, offers 5 Gb of mobile internet and unlimited Wi-Fi access plus all net unlimited voice and SMS. All of these plans include the *Meo Music*, which is otherwise priced at €4.99 or €6.99 per month, depending on whether it is an existing *Meo* customer.

In the prepaid market, *Meo* extended the all-day version of the “*e nunca mais acaba*” tariff plan to include unlimited all-day voice and SMS for *Meo* and fixed networks, while being able to apply, monthly, the equivalent of €20.00 toward voice minutes and SMS on other mobile networks. This tariff plan also includes unlimited in-network video calls and can be configured with a 500 MB mobile internet option for €25.00 per month. *Meo* also extended the *Moche* offering, for customers younger than 25 years of age, to include 1GB of mobile internet in the case of the monthly fee, and if the customer recharges the card with at least €11.00. The *Moche* tariff plans also include SMS options with respect to other networks. These changes in *Meo’s* tariff structure were in response to price movements in the market and were aimed at maintaining *Meo’s* competitive position in the market.

Pricing

We believe that mobile services in Portugal are priced lower than the European average and are among the lowest in Europe. Fixed-to-mobile and mobile-to-mobile interconnection charges are regulated by ANACOM and have a significant impact on our business. Since 2005, when ANACOM declared all mobile operators to have significant market power in call termination in mobile networks market, ANACOM has accordingly imposed price controls on interconnection rates for the termination of calls on mobile networks. Since the imposition of price controls, interconnection rates have been reduced steadily. ANACOM has issued successive decisions that have reduced mobile termination rates over time. Most recently, in March 2012, ANACOM issued a final decision reducing mobile termination rates progressively to €0.0127 by December 2012. These reductions have had, and are expected to continue to have, a significant impact on our interconnection revenues and consequently our cash flows and earnings.

Enterprise

Our enterprise services which are provided by PTC and Meo, S.A. comprise (i) network and voice services, which include fixed voice services, fixed and mobile convergence services, broadband data, Ethernet services, digital leased lines and VSAT services, business high band fiber-based internet, VPN accesses and applications, and global services for multinational customers; (ii) IT services, which include data center services (such as housing and hosting), cloud-based solutions (primarily public and private virtual servers, remote backup and storage, hosted e-mail and web hosting), security managed services based on a Security Operations Center, business continuity services and disaster recovery, IT infrastructure outsourcing and IT and security consultancy; and (iii) business solutions and applications, which include unified communications, IP Centrex and voice servers, digital signage—Corporate TV, messaging and interaction solutions, business video communications and telepresence solutions, machine-to-machine managed connectivity and vertical end-to-end solutions, business process outsourcing (BPO), vertical solutions for special business market customer categories (health care, the public sector), special bundling services for small and medium-size enterprises, using the “Office Box” brand name, and outsourcing.

We provide these services to our enterprise customers using a three-tiered approach: (i) *Residential+* customers, with an offering based on the convergence of voice and broadband services, (ii) *Connected+* customers, served mainly with multi-employee connectivity services, including mobility solutions for traveling employees, and simple software solutions and (iii) *Integrated+* customers, served with a full range of telecommunications and technological services, such as unified communications, outsourcing of information and communications technology (“ICT”) services, application integration, machine-to-machine and specific IT/IS solutions, BPO and IT consultancy.

The provision of services to our corporate customers is guided by the following strategic objectives: (i) maximize value from traditional telecommunications services by upselling additional services, including fixed- mobile convergence on FTTH, VPN, LAN management and video services, (ii) IT transformation accelerated by cloud computing, where we aim to build upon partnerships with key suppliers to enable business process transformation and cost reductions to our corporate customers, with a special focus on “system on a chip,” (“SOC”), based security solutions, (iii) capture mobile data growth through 4G-based solutions and new machine-to-machine projects, (iv) use specialization to achieve gains from scale, including by focusing on outsourcing and BPO to improve productivity and (v) introduce a business consulting approach in order to extend the services provided to corporations to video, multiscreen and other convergent services.

As part of our enterprise services, we provide a broad offer of integrated and vertical solutions. We continue to market our *Office-box* product for SMEs, which allows integrated solutions with one bill and on a pay-per-employee basis bundling voice and data communication needs: (i) connectivity: mobile and fixed voice and broadband, (ii) devices: PCs, phones and mobile phones, routers and switches and (iii) mobility: cloud solutions including customized domains, e-mail accounts, hosting sites and optional software. We provide vertical solutions through our *Office-box* product which includes tailored software systems for health clinics, restaurants, hotels, including access to an online marketing and booking system and a full suite of hotel-management software. For large corporations, we provide (i) integrated solutions, bundling customized connectivity and IT needs coupled with dedicated account managers, and (ii) a unified communications integrated offering without requiring capital expenditures on a pay-per-employee basis, including a flat voice rate, customer equipment and a full set of collaboration functionalities. Our secure cloud offering provides a broad portfolio of services, including (i) web services, such as webhosting, instant website, database hosting and e-mail relay, (ii) security services, comprising e-mail security, remote backup, video surveillance and clean pipes, and (iii) IT resources, including remote desktop, public and private servers, SAP HANA and virtual drives. We have developed this end-to-end offering with strategic partnerships that enable us to leverage our technological skills and integration capacity in key markets in Portugal, Brazil and Africa.

The IT and business process outsourcing for corporate customers leverages PT Cloud and Data Centres, a wholly-owned subsidiary of PT Portugal, which provides an integrated ICT service and IT/IS outsourcing capabilities, and PT Pro, *Serviços Administrativos e de Gestão Partilhados*, S.A., or PT PRO, a wholly owned subsidiary of PT Portugal, which allows the provision of BPO and shared services. See “—*Shared Services Companies*.”

Wholesale

In addition to the services we provide through PTC and Meo, S.A., in our primary customer categories of residential services, personal services and enterprise services, we provide wholesale services to other telecommunications operators and generate a small amount of revenue from other activities, such as public pay phones and the production and distribution of telephone directories. We report revenues from these services and products, together with eliminations for transactions among our residential, personal and enterprise customers, as “Wholesale, other and eliminations” in our consolidated financial statements.

Wholesale services provided €469.9 million, €476.0 million and €461.7 million to our operating revenues in 2011, 2012 and 2013, respectively. Our wholesale services consist of: (i) domestic and international interconnection telephone services that we provide to other telecommunications operators in Portugal; (ii) provision of carrier pre-selection and number portability; (iii) leasing of domestic and international lines to other telecommunications services providers and operators; (iv) provision of ADSL (including “naked” DSL) on a wholesale basis to other ISPs; (v) provision of unbundled access (including shared access) to metallic loops and sub-loops to provide broadband and voice services to other telecommunications operators in Portugal; (vi) provision of wholesale line rental to other telecommunications service providers in Portugal; (vii) provision of co-location services and access to ducts, submarine cable landing stations, poles and associated facilities to other telecommunications operators in Portugal; (viii) transmission of television and radio signals for major broadcast television companies in Portugal; (ix) narrowband internet access origination services, which we provide to ISPs; (x) international carrier services (transport, transit and/or termination) for international switched traffic; and (xi) other services provided to telecommunications services providers and operators, such as IP international connectivity.

Interconnection Traffic

Interconnection traffic comprised about 40% of our wholesale business in terms of revenues in 2013. The service providers who purchase interconnection services include fixed and mobile network operators, voice and data communications service providers, ISPs, value-added service providers and service providers whose international calls are terminated on or carried by our network. Providing interconnection services means allowing third parties to connect their networks to our network, and vice versa. We have interconnection rates primarily for call termination, call origination, transits and international interconnection.

Interconnection Prices

Domestic interconnection revenue per minute for calls terminated on our network decreased around 72% as of October 2013, from €0,0040 to €0,0011. International interconnection revenue per minute for wholesale operators’ outgoing traffic decreased by 18% in nominal terms in 2013 compared to 2012 and decreased by 8% in 2012 compared to 2011. In accordance with EU and Portuguese regulations, our national interconnection prices are cost-oriented, applying a pure Bottom Up Long-Run Average Incremental Cost, or BU-LRIC, cost model for call termination.

Leased Lines

We lease lines to other telecommunications providers for fixed, mobile and data communications services, including our competitors. Leased line services involve making a permanent point-to-point connection with dedicated and transparent capacity between two geographically separate points. We offer both national terminating segments and trunk segments at the wholesale level. We also lease international circuits to national and international operators to allow them to complete their circuits (often circuits that pass through Portugal before linking to other countries), and we sell segments of international circuits to international operators. The three current mobile telephone operators in Portugal, which include our subsidiary *Meo*, Vodafone Portugal and NOS, are among our wireline business’s largest leased line customers.

Telephone Directories

Under a Concession Contract dated February 20, 2014, we provide telephone directory universal services. We subcontract to Páginas Amarelas for the publication and distribution of telephone directories throughout Portugal in return for an annual payment of approximately 78% of its gross revenues from the sale of advertising space. Our revenues from our directories business amounted to €25.2 million, €34.7 million and €45.9 million in 2013, 2012 and 2011, respectively. We completed the disposal of our 25% interest in Páginas Amarelas to a third party in January 2014.

Digital Terrestrial Television Services

In 2008, pursuant to the European Commission’s proposal to cease analogue transmissions in all member states by 2012, ANACOM launched a public tender to grant the rights of use of frequencies allocated to the transmission of digital terrestrial television, or DTT, signals. Following a public tender launched by ANACOM in 2008, our subsidiary PTC was granted the frequency usage rights for DTT associated with the transmission of the signal for free-to-air television programs (the RTP1, RTP2, SIC and TVI broadcast channels), the so-called “Multiplex A” or “Mux A”. In 2008, the Portuguese media regulatory authorities (*Entidade Reguladora para a Comunicação Social (ERC) and ANACOM*) notified us of their final decision to grant us a license to act as a TV distribution operator. As a consequence, ANACOM assigned a right of frequency use to PTC. This right allows us to have national geographic extension and is valid until December 2023. There is a coverage obligation associated to the right46421479_13 of frequency use, namely 87.2% of national territory covered by terrestrial platform (Mux A) and 12.8% by complementary means (satellite). On the July 10, 2014, ANACOM published a draft decision related to the coverage obligations above, specifically on the evaluation methodology and technical parameters to be measured. The final decision, expected in 2015, may result in PTC bearing

additional costs and undertaking additional investments. Moreover, as early as May 2013, ANACOM decided that the Single Frequency Network (“SFN”), due to changes in spectrum international planning (700 MHz band), will evolve to a Multi Frequency Network (“MFN”) topology. Migration is to be concluded by 2017 and may also result in additional costs. In September 2014, when adopting the temporary licensing of four transmitters, ANACOM determined the presentation of a plan relating to the installation of additional MFN transmitters in areas with coverage problems. So far, the Authority has not yet formally ruled on the plan.

We launched DTT (using DVB-T, or terrestrial signals) in 2009, initially covering 29 municipalities and over 40% of the population. By the end of 2011 we achieved 100% coverage of the Portuguese population (approximately 90% using DVB-T and 10% using DVB-H (satellite)). The switch-off of the analogue television network in Portugal occurred on April 26, 2012.

DTT only encompasses broadcasting of free-to-air television programs, while our *Meo* offer comprises both free-to-air television programs, as well as Pay-TV channels, being provided over FTTH, ADSL and DTH technologies.

Marketing and Sales

We market our services through several different distribution channels, so as to meet our different customer segment needs and expectations.

From 2012 onwards, the focus of our marketing strategy has been on the brands in our personal segment. *Meo* is our primary and pre-existing brand and a leader in mobile telecommunications in Portugal, which we expect to continue using to serve the broader market and focuses on the growth of our post-paid base through dedicated tariff plans and attractive pricing policies in smartphones. *Meo* marketing campaigns continue to draw attention in the Portuguese Pay-TV market. In the third quarter of 2013, *Meo* aired a new campaign, *Mundo Meo*, to strengthen its market position as an innovative brand. This campaign describes *Meo*’s key differentiating features: (i) *Meo Kanal*, an application that allows users to produce, edit and share multimedia user content on television with other *Meo* customers; (ii) *Meo Karaoke*; (iii) PVR-experience; (iv) interactive apps, and (v) *Meo Music* (formerly *Music Box*), a music streaming service. Following our continuous investment in the *Meo* brand, in September 2013, *Meo* was named the brand of the year by *Meios e Publicidade*, an independent Portuguese specialized magazine.

We developed *Moche*, our new youth brand, to encourage a broad-based use of mobile internet. *Moche* employs a different business model and is supported by a new brand positioning and values and is tailored to the target youth demographic. We market personal services through more than 3,179 points of sale, including our sales force, retail shops, supermarket chains and independent dealers.

On January 27, 2014, we announced that all services rendered by TMN—Telecomunicações Móveis Nacionais, S.A. (“TMN”) would be provided under the *Meo* brand and that TMN had changed its corporate name to *Meo—Serviços de Comunicações e Multimédia*, S.A. This change is part of our convergence strategy and builds on our 2013 launch of *M4O*.

We also have a low-cost brand, *Uzo* that targets low-cost subscribers and uses our GSM network. *Uzo* focuses primarily on selling SIM cards and low-cost mobile phones to its customers. *Uzo*’s products and services are offered through the internet, *Uzo*’s call centers (which are separate from *Meo*’s call centers) and independent news stands and shops located throughout Portugal.

Customer Contract, Billing and Customer Service

We typically enter into standard form contracts with our residential and personal customers. The terms and conditions of our contract, including duration, termination rights and the ability to increase prices during the life of the contract differ across our segments. We aim to increase our customer satisfaction and decrease churn with high product quality and dedicated service. We provide our residential and personal customers with access to technical support help desks which operate at substantially all times. For our enterprises services, our institutional and business customers are also served by dedicated business service and customer care centers.

Network

For our fixed line network, we are focused on increasing our investment in FTTH, with 1.6 million homes passed in Portugal as of December 31, 2013, which represented about 46% of the population. As of September 30, 2014 we had 2.1 million homes passed in Portugal, after giving effect to the fiber sharing agreement with Vodafone (as further described below in “—Material Contracts—Fiber Sharing Agreement with Vodafone Portugal”).

The deployment of new access technologies and networks continues to be an overriding trend across the sector, with operators announcing plans, trials and investments in Next Generation Access Networks (“NGAN”), namely fiber-to-the-home (FTTH) networks in the fixed business and Long Term Evolution in the mobile business. Both technologies offer more speed, lower latencies and higher reliability. FTTH improves customer experience by providing higher and guaranteed speed, download and upload symmetry and lower latency. Moreover, fiber investment also supports an enhanced mobile network, with high-quality fiber connections for mobile base stations.

We provide mobile telephone services using the GSM, UMTS, and LTE technologies (2G, 3G and 4G, respectively). Within our GSM offering, we provide services in the 900 MHz and 1800 MHz band spectrums. GSM, UMTS and LTE are European and worldwide standards using digital technology.

In March 2012, ANACOM formally allocated to *Meo* rights to the following spectrum for 15 years following a multiband auction for the provision of electronic communications services based on LTE technology:

- 2 × 10 MHz in the 800 MHz band for a final price of €90.0 million;
- 2 × 14 MHz in the 1800 MHz band for a final price of €11.0 million; and
- 2 × 20 MHz in the 2.6 GHz band for a final price of €12.0 million.

Meo chose to pay these amounts in installments, as set forth in the auction regulation, which provided for an initial payment of €83.0 million, with the remainder €30.0 million being paid in five equal instalments for five-year period, from January 2013 to January 2017, and covered by a bank guarantee valid for that same period. This guarantee is released partially, on an annual basis, according to the payments made by *Meo*.

These rights are reflected in a license that includes and supersedes the previous GSM and UMTS licenses issued by ANACOM. The license imposes certain requirements on *Meo*, including the following:

- Mobile network obligations for 800 MHz: *Meo* must enter into agreements with Mobile Virtual Network Operators and national roaming agreements with operators with rights of use on frequencies greater than 1 GHz.
- Coverage obligations for 800 MHz: For each lot of 2 × 5 MHz in the 800 MHz band, *Meo* must cover a maximum of 80 parish areas out of 480 parish areas without adequate broadband coverage.

For more information about our licenses, see “Regulatory—Portugal—Our Concession and Existing Licenses and Authorizations”.

We paid spectrum fees in 2013, 2012 and 2011 of €14 million, €15 million and €17 million, respectively, for the use of our 900 MHz and 1800 MHz GSM network and our UMTS network. These spectrum fees are recorded as an operating expense in our consolidated financial statements.

In addition, through roaming agreements, our subscribers can make and receive mobile calls throughout Europe and in many other countries around the world. Roaming agreements between operators allow their subscribers to make and receive voice calls automatically, send and receive data, or access other services when traveling outside the geographical coverage area of the home network, by using the networks of other operators abroad. As of the end of 2013, we had entered into GSM roaming agreements with a total of 631 operators (in 231 countries) and 312 UMTS roaming agreements (in 139 countries).

In our Enterprise segment, we provide services over the largest IP/Multiprotocol Label Switching backbone in Portugal. We have a fully owned fibre backbone, with total capacity of more than 100 Tbps and high speed 100 Gbps interfaces, and a metro network with 2,658,000 km of fibre and 761 points of presence covering all major cities throughout Portugal, and we link our network to our customers’ premises through switches and access points that we own. This broadband data transmission network provides high capacity, flexibility and security and can progressively incorporate current voice and data infrastructures at lower costs than alternative networks. We also provide high speed internet access through ADSL and Ethernet.

Suppliers and Partnerships

We have implemented a multi-sourcing procurement policy for some technologies and continually monitor the role of suppliers in the chain.

In our Residential segment, for our fixed line network and Pay-TV services in 2013, we obtained telephones and equipment for our voice, broadband and Pay-TV services from several suppliers, including Novabase, Alcatel- Lucent and Motorola, and we obtain television content, including premium channels, from several national and international suppliers.

We do not manufacture handsets for our Mobile services, but we have agreements with a number of manufacturers to sell handsets in Portugal, including Nokia, Samsung, ZTE, Huawei, Apple, Sony, LG and RIM.

In our Enterprise segment, we have a strong and competitive position in the development of information technology solutions where communications are an integral part of the services provided. To reinforce our position as a leader in this area, we are pursuing a partnership strategy with the primary information technology suppliers in the market, particularly software and hardware providers.

We offer services in partnership with leading operators and service providers such as Telefónica, British Telecom and Orange. We use systems and networks in partnership with Nokia Solutions and Networks Portugal, Alcatel- Lucent, Ericsson, Huawei, Cisco Systems, Nortel Networks, Critical Software, Microsoft and SAP, among others. In 2012, we pursued partnerships with Microsoft and SAP, and in 2013 with Ericsson towards developing, implementing and continuously launching new services in our cloud computing offer, *SmartCloudPT*, which is intended to help companies adopt more efficient business models by reducing costs related to information technology.

In connection with the opening of the data center in Covilhã (further described below), we entered into a partnership with the University of Beira—Interior, and we are committed to attracting start-ups and technology companies into the Covilhã region in order to build an ecosystem of technological development that will turn our data center initiatives into an engine for business growth. Furthermore, we are also party to a number of EU grant agreements (including by way of accession to an existing grant agreement between the EU and a third-party, such as universities), each relating to a specific project, pursuant to which the EU agrees to provide grants towards the implementation of such projects.

Material Contracts

Fiber Sharing Agreement with Vodafone Portugal

In July 2014, we signed an agreement with Vodafone Portugal to deploy, swap of capacity and share fiber networks beginning in December 2014, for an initial term of 25 years. The initial term will be automatically renewed in additional periods of four years each, unless a party objects in writing to a renewal at least two years in advance of the termination date. The agreement includes sharing of dark fiber in approximately 900,000 homes, where each party grants to the other party an exclusive Indefeasible Right of Use (IRU) for certain PON network cells it owns (totalling approximately 450,000 homes each). Since the model is based on a swap of capacity through IRUs, the title to the PON network cells remains with the granting party, which allows both parties to maintain total autonomy and flexibility in designing retail offers, including the provision of RF (analogue) TV signal, and will ensure confidentiality of customer information. With this agreement, we expect to reach an additional 450,000 homes with fiber to the home technology by December 2015.

During the first ten years of the agreement, there is an undertaking of partnership between the parties for the construction of new PON network cells. A party must notify the other party if it wishes to build new PON network cells in any geographical area which does not correspond to the PON network cells already covered by the agreement. If the other party is also willing to build new PON network cells, both parties must then commit to the construction of new PON network cells in partnership with each other. This undertaking from each party does not apply after the first ten years of the agreement, nor does it apply when a party decides to build PON network cells in partnership with another operator (provided that such PON network cells are not covered by the agreement).

Additionally, each party to the agreement may transfer the entirety (but not part) of its PON network cells covered by the agreement to a third-party purchaser, provided that such purchaser also assumes the obligations of the selling party under the agreement. The non-selling party has a pre-emption right where the third party purchaser is a retail operator in the broadband market, which is not in the same 'economic group' as the seller. If the selling-party does not comply with the conditions to transfer and the pre-emption right, it will be subject to a penalty. In the event of a material and/or continuous default of one party, the other party may unilaterally terminate the agreement by exercising a call option.

Seasonality

Although our revenues and costs fluctuate from quarter to quarter, we do not experience large fluctuations due to seasonality. We tend to have higher revenues in the fourth quarter due to promotional campaigns centered on the Christmas holiday. To a lesser degree, promotional campaigns at the time of the Easter and Mother's Day holidays also tend to increase our revenues in the second quarter. In addition, our revenues from our operations tend to be lower during the third quarter when the Portuguese summer holidays occur.

Intellectual Property

We use a variety of trade names and trademarks in our business, including “Meo” and “M4O”, and several associated trademarks. All of our trademarks are protected in Portugal. Some of these trademarks also enjoy protection in the European Community and in African Portuguese speaking countries like Angola, Mozambique and Cape Verde. We possess a certain number of patents, designs and copyrights, but we believe that such industrial and intellectual property rights do not play a material role in our business. We license some of the television programming content for our pay television offering from third party providers. Certain of these licenses contain change of control provisions at the level of the operating subsidiaries, and certain licenses require the third party providers’ consent should we wish to assign such licenses to other parties (with certain carve-outs for assignments to affiliates).

Employees

As of December 31, 2013, we employed 11,025 full-time permanent employees. As of September 30, 2014, we employed 10,751 full-time permanent employees. We also employ contract and temporary employees for various projects.

We are subject to various labor laws in Portugal, which govern the length of the workday, minimum wages for employees, procedures for hiring and dismissing employees, determination of severance pay, annual leave, sick days, advance notice of termination of employment, equal opportunity and anti discrimination laws and other conditions of employment. PT Comunicações S.A., MEO—Serviços de Comunicações e Multimédia, S.A., PT Cloud e Data Centers, S.A., PT Inovação e Sistemas, S.A., PT ACS—Associação de Cuidados de Saúde, PT Centro Corporativo, S.A. and Fundação Portugal Telecom are also subject to a collective bargaining agreement executed between these companies and several trade unions.

We are also liable for certain post-retirement benefits, including: (i) pension supplements, (ii) healthcare, and (iii) remuneration of employees under suspension and pre-retirement agreements (which remuneration paid on a monthly basis until such suspended/pre-retired employees reach the statutory retirement age). Under several defined benefit plans, PTC and PT Cloud e Data Centers, S.A. are responsible to pay pension supplements to a group of employees. In order to finance these obligations, PTC incorporated various funds, which are supervised by the *Instituto de Seguros de Portugal* (Portuguese Insurance and Pension Funds Supervisory Authority) and are not entirely capitalized. Additionally, under a defined benefit plan, PTC and PT Cloud e Data Centers are responsible to pay health care expenses to a group of employees and its relatives. This health care plan (covering 23,402 beneficiaries, approximately 23% of which are still in service) is managed by Portugal Telecom—Associação de Cuidados de Saúde (“PT-ACS”). In 2004, the Group established PT Prestações—Mandatária de Aquisições e Gestão de Bens, S.A. (“PT Prestações”) to manage an autonomous fund to finance these obligations. See “*Management’s Discussion and Analysis of Financial Condition and Results of Operations of the PT Portugal Group—Post Retirement Benefits*”. Further, we are generally required to provide severance pay upon the dismissal of an employee. We are also required to make national insurance payments on behalf of our employees to the Portuguese government.

Data Centers and Other Properties

We lease and own certain properties for our corporate offices, sales offices, broadcast centers, communication rooms, customer service centers, sales stores, mobile network sites, hubs, switches and head-end sites. Our registered office is located at Avenida Fontes Pereira de Melo, Lisbon, Portugal. We believe that our properties meet their present needs and are generally well—maintained and suitable for their intended use. We believe that we generally have sufficient space to conduct our operations but maintain flexibility to move certain operations to alternative premises.

Our data center network consists of seven data centers located in Lisbon, Oporto, the Azores, Madeira and Covilhã (which was opened in September 2013). The opening of the data center in Covilhã, a large, efficient and sustainable facility, is the culmination of five years of transforming our cultural, technological and business model. The center provides the base infrastructure for offering solutions that will serve the needs of national and international individuals and businesses, and we believe it marks a milestone in our transformation into a global operator. Against the backdrop of exponential growth in global data usage, we believe the Covilhã data center provides us with the technological means to respond to what customers want: coverage, speed, reliability and security. Furthermore, the opening of the data center in Covilhã also represents a boost for Portuguese technology and growth of cloud solutions in Portugal.

The Covilhã data center occupies a total area of 75,500 square meters and increases the total IT room space from 14,000 square meters to 26,000 square meters, the number of servers from 6,000 to 56,000, capacity storage from 3 Pbytes to 33 Pbytes. This data center is connected to our backbone network (100 Gbps), enabling the export of data storage capacity and technological services abroad. From a sustainability and energy efficiency point of view, the data center saves 144 thousand tons of CO₂ and 40% in energy consumption, while using environmentally responsible cooling (free cooling) systems for 99% of the year and solar energy.

Environmental

We are subject to a variety of laws and regulations relating to land use, environmental protection and health and safety in connection with our ownership of real property and other operations, including laws regulating non-ionic radiations emitted as a result of our mobile services. While we could incur costs, such as clean-up costs, fines and third party claims for property damage or personal injury, as a result of violations of or liabilities under such laws or regulations, we believe we substantially comply with the applicable requirements of such laws and regulations and follow standardized procedures to manage environmental risks. Given our activities and our current property, plant and equipment, we believe that there are no environmental factors likely to have a significant impact on the use of our current property, plant and equipment, other than as disclosed in these Listing Particulars in “*Risk Factors—Risks Relating to Our Business, Technology and Competition—Our business may be adversely affected by actual or perceived health risks and other environmental requirements relating to exposure to electromagnetic fields through telecommunications equipment.*”

Insurance

We maintain a property insurance policy with wide coverage based on “extended fire” wording to cover our property on a new replacement basis. We also maintain a business interruption policy based upon the same perils. The property coverage is supported by coverage for electronic equipment. We maintain various liability insurance policies including general liability, comprehensive third party liability, products liability & professional liability, multimedia liability and employer’s liability insurance policies. In addition to these policies we maintain motor vehicle insurance policies, heavy equipment policy, open policy for contract works to cover maintenance and development works and few other small policies. We have directors’ and officers’ liability insurance policies that cover all members of our executive management. We do not insure against certain operational risks for which insurance is unavailable or which can only be insured at what we believe to be on unreasonable terms.

In our view, the sum insured, the limits of liability, the deductibles and scope of cover in our policies are satisfactory and suitable for companies acting in the telecommunications sector (subject to the wording of the policies, conditions and exclusions). However, we cannot guarantee that no losses will be incurred or that no claims will be filed against us which go beyond the type and scope of the existing insurance coverage.

Legal Proceedings

We are involved in a number of legal and administrative proceedings arising in the ordinary course of our business. The legal proceedings initiated against us include, amongst others, the following categories of claims: claims by or on behalf of customers on various grounds such as alleged misrepresentation or breach of service or license terms or breach of telecommunication, broadcasting, consumer or health and safety regulations, intellectual property claims primarily relating to alleged copyright infringement brought by copyright collection societies, claims by suppliers and other telecommunications providers, claims by employees and claims by regulators.

We proactively manage our litigation risks by assessing disputes where we believe the claimant may have merit and attempting to settle such disputes on favorable terms, including in the case of suits seeking certification as class action suits at a stage prior to such certification, and contesting others where we believe the claim does not have merit. We record a provision when there is a sufficient probability that a dispute will result in a loss and the amount of such a loss can be reasonably estimated. Other than as discussed below or elsewhere in these Listing Particulars, as of the date of these Listing Particulars, we are not aware of any administrative, judicial or arbitral proceedings (including any pending or threatened proceedings) that are likely to have or have had over the course of the last twelve months a material adverse effect on our financial condition or results of operations. The outcome of legal proceedings, however, can be extremely difficult to predict with certainty, and we can offer no assurances in this regard.

Tax Proceedings

Claims for Municipal Taxes and Fees

Pursuant to a statute enacted on August 1, 1997, as an operator of a basic telecommunications network, we were exempt from municipal taxes and rights-of-way and other fees with respect to our network in connection with our obligations under our concession. The Portuguese government has advised us in the past that this statute confirmed the tax exemption under our concession. The Portuguese government has advised us it will continue to take the necessary actions in order for us to maintain the economic benefits contemplated by our concession.

Law 5/2004 of February 10, 2004 established a new rights-of-way regime in Portugal whereby each municipality may establish a fee, up to a maximum of 0.25% of each wireline services bill, to be paid by the customers of those wireline operators whose network infrastructures are located in each such municipality. This regime was implemented in 2005, but some municipalities interpret Law 5/2004 as having no effect on their authority to establish other taxes but rather

interpret Law 5/2004 as affecting only federal and regional taxing authorities. In 2009, Decree Law 123/2009, of May 21, 2009, clarified that no other tax should be applicable by municipalities in addition to the regime established by Law 5/2004 of February 10, 2004. This interpretation was confirmed by the Supreme Administrative Court of Portugal in several cases. Some municipalities, however, continue to hold the position that the Law 5/2004 does not expressly revoke other taxes that the municipalities wish to establish, because Law 5/2004 is not applicable to the public municipality domain. We continue to be parties to legal proceedings in some municipalities regarding this matter.

Tax Contingencies

Certain of our subsidiaries are subject to tax claims that relate primarily to the deductibility of certain financial costs incurred between 2004 and 2010 (€241.0 million). As of September 30, 2014 we strongly disagree with these assessments and believe, based on the opinion of our tax advisors, that there are solid arguments to oppose the position of the tax authorities. We do not consider the losses related to these tax contingencies to be probable or possible.

Regulatory Proceedings

ANACOM

We are regularly involved in regulatory inquiries and investigations involving our operations, including from ANACOM regarding our compliance with applicable laws and regulations. See “*Risk Factors—Risks Relating to Legislative and Regulatory Matters—We are subject to significant government regulation and supervision, which could require us to make additional expenditures or limit our revenues and otherwise adversely affect our business, and further regulatory changes could also adversely affect our business—Portugal*” and “*Risk Factors—Risks Relating to Legislative and Regulatory Matters—We can only operate our business for so long as we have licenses from the relevant authorities in the jurisdictions in which we operate*”. As of September 30, 2014, we had on-going administrative offence procedures initiated by ANACOM in an aggregate amount of approximately €42.6 million (though the maximum possible fine for an individual proceeding is capped at €5 million), for which we have provisioned approximately €2.9 million.

In addition, the European Commission regularly make, and the Portuguese Competition Authority may make, inquiries and conduct investigations concerning our compliance with applicable laws and regulations, as further described below in “*—European Commission Investigations*”.

We believe that we have consistently followed a policy of compliance with all relevant laws. We continually review our commercial offers in order to reduce the risk of competition law infringement. We believe that most of the complaints that have resulted in such investigations should be dismissed due to the nature of the alleged abuses. However, if we are found to be in violation of applicable laws and regulations in these or other regulatory inquiries and investigations, we could become subject to penalties, fines, damages or other sanctions.

European Commission Investigations

In January 2011, the European Commission opened an investigation into an agreement between Telefonica and Portugal Telecom SGPS allegedly not to compete in the Iberian telecommunications markets. In January 2013, the EC adopted a decision finding that Portugal Telecom SGPS, S.A. and Telefonica had infringed Article 101 of the Treaty on the Functioning of the European Union with reference to Portugal Telecom’s July 28, 2010 agreement with Telefónica concerning the acquisition by Telefonica of Portugal Telecom SGPS., S.A. stake in Brazilian operator Vivo. In accordance with this decision, Portugal Telecom SGPS., S.A. was fined in the amount of €12.29 million. The January 2013 decision ended the investigation which began in January 2011, in which the European Commission analysed the relationship between both companies since 1996.

On April 9, 2013, Portugal Telecom SGPS brought an action for annulment before the General Court of European Union (the first level of appeal of the EU courts) and will continue to vigorously defend the matter. The matter is now waiting to be tried before the General Court. We note that the EU appeal courts have unlimited jurisdiction to review decisions where the EC has fixed a fine (including cancelling, reducing or increasing the fine).

Although the European Commission’s decision was addressed to Portugal Telecom SGPS, PT Móveis, S.G.P.S, S.A. was expressly mentioned in the decision as being involved in the alleged infringement (even though it is not the addressee of the European Commission decision). Portugal Telecom SGPS is therefore solely responsible for the payment of the fine. While the appeal is pending the payment of the fine was secured with a bank guarantee (with an initial term of one year that is automatically extended for additional periods of one year each). While this bank guarantee is in place, the European Commission will not enforce their decision in order to collect the fine. Accordingly, no provision has been recorded with regards to this matter.

Civil Proceedings

Potential Claims

PTC is subject to a potential compensation claim of approximately €16.8 million by Estradas de Portugal relating to PTC's use of a technical road channel between 2007 and 2014. Portugal Telecom Data Center, S.A. is also subject to a potential compensation claim of approximately €16.2 million by ACE Opway/Somague concerning alleged losses relating to works carried out in Covilhã's Data Center. As of the date of these Listing Particulars no formal legal proceedings have been initiated with regards to these claims.

Sonaecom Claim

On March 19, 2010, Sonaecom—Serviços de Comunicações, S.A. (“Sonaecom”) filed a claim against Meo, .S.A., in relation to interconnection agreements between Sonaecom and Meo, S.A. Sonaecom alleged that PTC's statement of compensation regarding the Optimus—Comunicações, S.A.'s credits assigned by TMN—Telecomunicações Móveis, S.A., are invalid. Sonaecom claimed an amount of approximately €25.4 million from Meo, S.A. PTC joined the proceedings as a defendant as it accepted the assignment of credits. We are currently waiting for the date of the final hearing to be set. Meo, S.A. has made a provision for approximately €9 million.

Zon TV Cabo Claim

On 2 November 2011, Zon TV Cabo Portugal, S.A. (“Zon TV Cabo”) filed a claim against PTC, claiming compensation for damages arising from PTC's alleged refusal of portability requests between 2008 and 2009. The claim is for approximately €22.4 million, and we have not made any provisions for it. The proceeding is currently on-going.

Caixa Geral de Aposentações Claim

On July 26, 2010, Caixa Geral de Aposentações (“CGDA”) filed an administrative procedure claim against PTC, alleging that PTC failed to pay monthly contributions to the pension fund equivalent to 3.75% of the salaries of staff subject to the quota discount, in an aggregate amount of approximately €16.3 million. On December 20, 2010, PTC acknowledged the debt and agreed to pay approximately €17.8 million to settle CGDA's claim. Additionally, PTC also agreed to pay approximately €1.8 million to settle a tax claim included in CGDA's filing. We are currently awaiting judicial decision on the extinction of the proceedings.

TV TEL Claim

In March 2004, TV TEL Grande Porto—Comunicações, S.A. (“TV TEL”), a telecommunications company based in Oporto, filed a claim against PTC in the Lisbon Judicial Court. TV TEL alleged that PTC, since 2001, has unlawfully restricted and/or refused access to the telecommunications ducts of PTC in Oporto, thereby undermining and delaying the installation and development of TV TEL's telecommunications network. TV TEL alleges that PTC intended to favor both itself and TV Cabo. TV TEL claimed an amount of approximately €15 million from PTC for damages and losses allegedly caused and yet to be sustained by that company as a result of the delay in the installation of its telecommunications network in Oporto. In addition, TV TEL demanded that PTC be required to give full access to its ducts in Oporto. PTC submitted its defense to these claims in June 2004, stating that (1) TV TEL did not have a general right to install its network in PTC's ducts, (2) all of TV TEL's requests were lawfully and timely responded to by PTC according to its general infrastructure management policy and (3) TV TEL's claims for damages and losses were not factually sustainable. The trial was concluded in 2011, and a judicial decision was issued which required PTC to accept all the access requests which were previously denied. Both TV TEL and PTC appealed the decision. On June 6, 2014, the Court of Appeals of Lisbon decided in favor of PTC, but also ordered a re-trial with regards to a specific set of new facts relating to the proceedings. The parties are currently waiting for the date of the re-trial to be set. We have made a provision of €1 million for this proceeding.

Optimus Claim

In March 2011, Optimus—Comunicações S.A. (“Optimus”) filed a claim against PTC in the Judicial Court of Lisbon for the payment of approximately €11 million. Optimus supported its position by arguing that they suffered losses and damages as a result of abuse of dominant position and margins squeeze regarding the gross market of broadband. We are waiting for the trial to begin. Based on the opinion of our internal and external legal counsel, we have not recorded any provision for these matters.

REGULATORY

General

Our business is subject to various regulatory requirements and obligations including communications and broadcasting laws, general antitrust law, environment, health and safety laws, planning and construction laws, consumer protection laws as well as technical and other regulations in each of the jurisdictions in which we operate. Such laws and regulations are promulgated and enforced to varying degrees by supranational regulators such as the EC and national, state, regional and local authorities. The ever-changing regulatory environment can have a material effect on our activities. Certain key provisions of the regulations governing our activities in Israel, Portugal, Belgium, Luxembourg, the French Overseas Territories and the Dominican Republic as at the date of these Listing Particulars are set forth below. This description is not intended to be an exhaustive description of all regulation in this area nor a review of specific obligations which have been imposed on us.

Israel

The communications and broadcasting industry in Israel is highly regulated and requires service providers to obtain licenses from, and comply with the terms of such licenses and policy statements of, the Israeli Ministry of Communications or the Council for Broadcasting by Cable and Satellite (the "Broadcasting Council") with respect to the various communications and broadcasting services, respectively, before offering them to the public. The ever-changing regulatory environment can have a material effect on our activities. In this section only, references to "we", "us", "our", "HOT" and the "Company" may refer to HOT Telecommunication Systems Ltd, HOT Telecom, HOT Mobile, HOT Net, HOT Mobile International Ltd. or, collectively, HOT Telecommunication Systems Ltd. and its subsidiaries, as the context requires.

As a general matter, the regulatory principles are set forth in the laws enacted by the Israeli legislature (the "Knesset"), primarily the Communications Law (Telecommunication and Broadcasting), 5742-1982 (the "Communications Law"), as described below. These laws are amended from time to time upon enactment of the Knesset. The laws authorize the Israeli Ministry of Communications (in some cases with the approval of the Economic Affairs Committee of the Knesset) and the Broadcasting Council to issue regulations which provide for specific requirements based upon the principles set forth in the laws. The Israeli Ministry of Communications grants licenses in accordance with the Communications Laws and regulations. In addition to the regulations, the Israeli Ministry of Communications issues policy statements after a public review and consultation process. These policy statements expand upon the Israeli Ministry of Communication's policy with respect to certain basic issues in the relevant market.

Television

Overview

Our television operations are subject to extensive legislative and regulatory requirements that apply to the telecommunication industry in Israel, including the Communications Law, and the regulations enacted in accordance with it. We are also subject to specific legislation applying to the television broadcasting industry in Israel, such as the Harmful Broadcasts Classification, Marking and Prohibition of Damaging Broadcasts Law, 5761-2001 (which imposes certain classification and marking obligations with respect to television broadcasts) and the Television Broadcasts Law (Sub-Titles and Sign Language), 5765- 2005 (which imposes certain obligations regarding the accompaniment of television broadcasts with sub-titles and translation into sign language).

We provide our television services pursuant to a non-exclusive general cable broadcasting license issued by the Broadcasting Council that applies to all areas of the State of Israel and a non-exclusive general cable broadcasting license applying to Judea and Samaria (the "Broadcasting Licenses"). The Broadcasting Licenses contain certain conditions and restrictions relating to the provision of cable television services to our customers, including amongst others, a requirement to extend our services to customers in all areas of Israel which, in some cases, creates an obligation on us to provide services even though it would not be worthwhile economically to do so. There are certain places in Israel in which we do not currently provide services. In November 2014, the Israeli Ministry of Communications issued an order requiring us to provide services in some of those areas. The Broadcasting Licenses also stipulate the maximum fees that may be charged for our analog package. Our Broadcasting Licenses are valid until 2017 and may be extended for periods of 10 years at a time by the Broadcasting Council. We also have a special license (held by HOT Telecom) for operating a broadcasting hub which is valid until April 2017. As a general rule, the Broadcasting Licenses are non-transferable. In addition, the transfer of any means of control in the relevant license holders may be subject to prior approval of the Israeli Ministry of Communications and the Broadcasting Council.

Our operations in the pay television segment are subject to the supervision of the Israeli Ministry of Communications and the Broadcasting Council, including, among other things, in connection with the prices of analog services, broadcasting

content, and launching of new channels or ceasing to broadcast existing channels. In addition, we have been declared a monopoly in the area of multi-channel television broadcasts for subscribers, and accordingly, the Anti Trust Commissioner (the “Commissioner”) is permitted to issue instructions to us pursuant to the Restrictive Business Practices Law, 5748-1988. Accordingly, our ability to make acquisitions in the broadcasting sector will be limited. The Commissioner has set various conditions which apply to us as part of its decision to approve the Israeli cable consolidation. These conditions include, among others, separation of broadcasting and cable infrastructure activities, limitations on possessing means of control and relationships with producers of the channels, limitations on the purchase of, and the exclusivity in, programs and ownership of broadcast programs, limitations on agreements with producers of channels, a requirement to provide telephony services, investing in infrastructure, and the provision of bank guarantees. We are also subject to general antitrust law which prohibits certain restrictive agreements and the abuse of dominant market positions. Certain key features of the regulations and Broadcasting Licenses governing our television operations, including certain proposed regulatory changes that may have a significant impact on our operations, are set forth below.

Obligation to Extend Services

Under the terms of the Broadcasting Licenses, we are required to extend our cable television services to customers in all areas of Israel even where it would not be economically profitable to do so. Although we extend our services to most of Israel, there are currently certain areas of the country where we do not. In November 2014, the Israeli Ministry of Communications issued an order requiring us to provide services in some of these areas.

Access to DTT Channels

The Second Authority for Television and Radio (the “Second Authority”), a statutory body set up under the Second Television and Radio Authority Law (the “Second Authority Law”), is responsible for facilitating the development of, and regulating, commercially operated television and radio broadcasts in Israel. Pursuant to an amendment to the Second Authority Law, the Second Authority was charged with planning, establishing and operating, itself or via others, digital broadcasting stations for the free reception and distribution of television broadcasts (“DTT”) to the general public. Accordingly, in August 2009, the Second Authority launched broadcasts on a nationwide basis, enabling the free distribution to the public of the following DTT channels: the Israeli Broadcasting Authority channels (Channels 1 and 33), the commercial television channels (Channels 2 and 10), the Knesset Channel (Channel 99) and, recently, the Educational Channel (Channel 23). The establishment of the digital broadcasting stations infrastructure enables subscribers to view the broadcasts of DTT channels free of charge upon purchasing a set-top box. We are also required to carry the DTT channels over our network.

In April 2012, the Distribution of Broadcasts through Digital Infrastructure Law, 5772-2012 was passed into law (the “DTT Law”). Pursuant to the DTT Law, the state will finance the first three multiplexes of the DTT array allowing the broadcast of up to 18 channels. Currently, the DTT has already been expanded to include all radio channels broadcasted in Israel and an educational television channel. Additional DTT channels due to be included in the DTT array may include, among others, the Israeli Russian language Channel (Channel 9), the Israeli Music Channel (Channel 24), the Israeli Arabic language Channel, three additional channels dedicated to specific themes and HD versions of any of the channels included in the DTT array.

The draft economic plan for 2013-2014, published by the Ministry of Finance in April 2013, and approved by the Government in May 2013 and by the Knesset in August 2013 (the “Economic Plan”), determined to amend the DTT Law in the following ways:

- The Minister of Communications (the “Minister”) and the Minister of Finance will be authorized to appoint a body that will act as an operator of the DTT array under the law, and the Minister will be authorized to set limitations on holding and ownership of such an operator (subject to the approval of the Knesset Economic Committee), with respect to its activities, and regarding tying between services (which, according to the DTT Law, would otherwise be prohibited).
- The Minister and the Minister of Finance, subject to consultation with the Council for Cable and Satellite Broadcasting (the “Council”), was, by January 1, 2014, to establish criteria for the use of a multiplexer that has not been used for propagating broadcasts on the DTT Array. However, to date, no such criteria have been forthcoming.
- In general, a body whose broadcasts are distributed through the DTT array will pay the aggregate payments and costs as set forth in the law, and the State will not bear the costs for the unused capacity in the DTT array.
- To amend Article 13 of the DTT Law to provide that:

- The Council may grant a license for theme channel broadcasting which will be distributed through the DTT array. Such license shall be granted to the operator selected in a tender based solely on the price offered for DTT array, subject to the limitations on participation in the tender prescribed in section 13 (d) of the DTT Law.
- The winning bidder shall, after its selection, decide to which of the following its broadcasts will be devoted: sports, kids, movies, nature, series, documentary, news, music, history, culture or any other topic that the Minister, in consultation with the Second Authority for Television and Radio and the Council, with the approval of the government, determines to be a defined and specific issue for which there is justification to broadcast through a theme channel on the DTT array. Notwithstanding the aforementioned, the bidder will be required to notify in advance its intention to devote its broadcasts to news.
- A theme channel transmitter may finance its broadcasting (other than children's channels which may not be financed through commercials) through commercials or by charging subscribers a fee for receiving the broadcasts of the same channel.
- A holder of cable or satellite broadcasting license, in accordance as defined in the Communications Law (Telecommunications and Broadcasting) 1982 (the "Communications Law"), may not participate in the theme channel tender.
- An amendment to the Communications Law authorizes the Minister to promulgate regulations for determining the holdings of an Israeli citizen and resident in a Broadcasting Licensee pursuant to the Communications Law (currently, 26% of each of the "Means of Control", as defined in the Law, in a licensee). Granting such authority to the Minister may simplify the regulatory requirements applicable to HOT in this regard.

Narrow Package Proposal

In September 2012, the Broadcasting Council made a decision to compel both multi-channel television broadcasters to offer, in parallel with a basic package of channels, a more limited basic package of channels (the "Narrow Package") on a pilot basis, with the goal of reducing the cost of the most basic pay television services. We launched our Narrow Package on December 2, 2012, which included all the channels distributed through the DTT array and 10 other channels (16 channels in total), which included sport, children and youth, series and movies and global news in accordance with the Broadcasting Council's decision.

The Communications Law has been amended in the following manner to regulate the introduction of a narrow broadcasts package:

- The Minister shall be authorized to determine, for a limited period not exceeding three years (subject to extension in consultation with the Broadcasting Council), provisions regarding the obligation of a cable and satellite broadcasting license holders ("a Broadcasting Licensee") to generally offer a narrow package containing a limited number of channels (the "Basic Narrow Package"), in accordance with the guidelines determined by the Minister regarding the mix of channels therein, and under a price determined by him. The Narrow Package will be offered in addition to the basic broadcasts package that Broadcasting Licensees must offer to all subscribers by law.
- The Broadcasting Council will be empowered to set the channels to be included in the Basic Narrow Package in accordance with the guidelines, and to set instructions regarding the publication of a Basic Narrow package.
- A Broadcasting Licensee shall not charge a subscriber of the Narrow Package payments, beyond the price thereof, for ancillary services such as installation fees, installation costs, etc. (the "Related Services"), if it does not charge payment for those Related Services from subscribers of other packages. If a Broadcasting Licensee charges fees for such Related Services, the payment charged to Basic Narrow Package subscribers shall not exceed the payment charged to subscribers of other packages.
- If the Minister exercises his authority to require a Broadcasting Licensee to offer a Basic Narrow Package, the Council will not be authorized to set rules with regard to a Broadcasting Licensee's obligation to offer such a package.
- In August 2013, the Council published a proposal regarding a Basic Narrow Package to be offered by a Broadcasting Licensee. As of the date of these Listing Particulars, no final policy has been determined.
- On February 20, 2014, HOT and the satellite company began to offer new basic packages to their subscribers at a tariff of NIS 120 that included a range of channels including DTT channels and the designated channels, as well as additional channels. In addition the companies will permit every customer to add, at his choice, single channels at the list price.

- As part of the new basic packages, HOT began to offer two plans: one aimed at children and the other intended for sports fans.
- HOT estimates that the basic packages offered by it are likely to lead to a significant increase in the number of subscribers to the basic package in a way that may harm HOT's business results.

Ownership of Television Channels

We are subject to regulatory limitations in connection with the ownership and production of television channels, including the rules set forth in the Communications Rules (Telecommunication and Broadcasting) (Broadcasting Licensees), 5748-1987 ("Communications Rules"). Pursuant to the provisions of the Communications Rules we are subject to restrictions regarding the number of channels that we can produce ourselves or in collaboration with another broadcasting license holder, such that the number of such television channels does not exceed two-fifths of the number of independent channels that we broadcast on our network. However, we are subject to more restrictive ownership rules pursuant to the decision of the Broadcasting Council approving the Israeli cable companies merger in 2006. Accordingly, the number of channels that we can produce, including channels produced by our predecessor companies at the date of approval, must not exceed 20% of the independent channels that we broadcast. In addition to those channels, we are also permitted to hold controlling interests in additional channels so long as the number of such channels does not exceed 4% of the total independent channels that we broadcast and we are not the controlling shareholder of such independent channels.

We are also subject to the decision of the Commissioner approving the cable merger in 2006, pursuant to which we are only permitted to hold means of control in the HOT 3 Channel and the HOT Movies Channel (previously Channels 3 and 4) and four additional channels which were not broadcasted in the cable infrastructure as of January 2005, or a similar channel to these channels, unless we obtain prior approval of the Commissioner.

Minimum Investment in Local Content Productions

In accordance with the Communications Law, the Communications Rules and decisions of the Broadcasting Council, we are required to invest at least 8% of our annual television revenues from subscriber fees in local productions to be broadcast for the first time over our network. During 2010, 2011, 2012, and 2013 we fulfilled the required rate of investment. In 2011, the Broadcasting Council notified our Group that with effect from 2012, the revenues from subscription fees forming the basis for calculating the minimum investment requirement must also include all payments made by customers for the purpose of receiving their broadcasts, including revenues from the rental of set-top boxes. We disputed this stipulation in writing to the Broadcasting Council. In response, the Broadcasting Council has permitted us to deploy the additional investment amount required in 2012 as a result of the new basis of calculation over the next three years in equal proportions.

The Israeli Ministry of Communications has appointed two committees to review the regulation of commercial broadcasting and local content production on commercial channels. See "*Proposed Changes in the Regulation of Audio-Visual Content*" below.

Special Licenses for Cable Broadcasts

Under the Communications Law, the Broadcasting Council is permitted to grant special licenses for cable broadcasts with a view to increasing the number of competitors involved in the broadcasting industry. In such cases, the general broadcasting licensees will be required to transmit the special licensee's broadcasts over their networks subject to the condition that the capacity available to the general broadcasting licensee will not fall below five-sixths of the total capacity available over its network. In August 2007, the Israeli Minister of Communications determined the minimum carriage fee to be paid by a special licensee for distribution of its channel by a general cable broadcasting licensee. We are also required to maintain a minimum level of capacity for transmitting special licensee broadcasts pursuant to the conditions established for approving the Israeli cable consolidation. In addition, in accordance with the Communications Law, the Broadcasting Council is permitted to grant special licenses to the broadcasters of designated channels. Unlike other special licensees, the designated channel licensees are not obliged to pay a carriage fee to the general broadcasting licensee although the parties are free to agree to such consideration contractually.

Prohibition of Termination Fees

In 2011, the Communications Law was amended to prohibit a license holder from collecting an exit or termination fee from residential and business subscribers whose monthly bill is under NIS 5,000 who terminate their agreement with the license holder before the end of the minimum term of such agreement. While a license holder is permitted to collect the balance of the payment in respect of end-user equipment purchased by the subscriber and debts accumulated by the subscriber, if payment for end-user equipment is due in installments, the license holder is not permitted to demand

immediate repayment of the entire balance. With regards to some residential and small business subscribers with contracts which predate the effectiveness of the amendment, the termination fee is limited to a maximum of 8% of the subscriber's monthly account, multiplied by the number of months remaining until the end of the commitment period. The maximum amount does not include the purchase price or rental amount of end-user equipment.

In addition, pursuant to a decision of the Broadcasting Council in 2011, we are permitted to collect payments from new subscribers only in respect of services provided in the past month and cannot collect payment for service in advance. This decision has had an impact on our cash flows as we transition customers to a post-services billing basis.

Prohibition on Advertising

The Communications Law prohibits broadcasting licensees from including commercials in their broadcasts other than promotional advertisements for upcoming broadcasts. Commercial channels, including certain "must carry" channels, and foreign channels may be permitted to include commercials on their channels.

Proposed Transition from Franchises to Licenses for Television Broadcasts

Currently, the commercial DTT channels such as Channel 2 and Channel 10 are operated on an exclusive franchisee basis granted by the Second Authority. However, an amendment to the Second Authority Law, passed in February 2011, proposes to increase the number of broadcasters by transitioning from the exclusive franchisee system to a non-exclusive license system under which any entity which satisfies certain threshold conditions may apply for a commercial broadcasting license.

In September 2014, an additional proposed amendment to the Second Authority Law was published which provides for the transition from an exclusive franchisee system to a non-exclusive license system in April 2015.

Fees and Royalty Payments

The Communications Law obligates general telecommunications licensees to pay royalties to the State of Israel. The regulations enacted under the Communications Law provide for an ongoing decrease in the rate of royalties applicable to such licensees, which have been reduced to 0% commencing on January 2, 2013.

In addition, in accordance with an agreement dated July 2001 between HOT and the State of Israel regarding the consideration payable to the State of Israel for the cable infrastructure, HOT has undertaken to pay the State of Israel payments at a rate of up to 4% of its revenue until the end of 2014. Under this agreement, in each year ended December 31, 2011, 2012 and 2013, and in the nine months ended September 30, 2014, we incurred expenses with the State of Israel of NIS 57 million, NIS 58 million, NIS 58 million and NIS 41 million, respectively. See "*General Information—Material Agreements—Agreement with the State of Israel relating to ownership of our cable network*".

Proposed Changes in the Regulation of Audio-visual Content

On February 5, 2014, the Minister of Communications announced the creation of a public committee (the "Shecter Committee") for evaluating the future arrangement of commercial broadcasts against the background of technological developments, changes to viewing habits, and the move to broadcasts over the internet. The Shecter Committee will examine, and formulate its recommendations on, amongst other things, the principles and rules of regulation that should apply to all players (both new and traditional) that engage in the distribution of audio-visual contents.

The Shecter Committee published a public hearing for reference and positions focusing mainly on the principles of regulation and rules that apply to all bodies (new and traditional) engaged in distributing audio-visual content, including via the internet, and alternative models of supervision in the field of audio-visual content. HOT submitted its position to the Committee in writing on April 24, 2014, and presented its comments orally to the Committee. HOT believes that the entry of new competitors to the field of broadcasting over the internet, especially if they are not to be subject to regulation (or on the same terms as traditional broadcasters), may have an effect of intensifying competition in the sector and may have a negative impact on business operations in the broadcasting industry. On August 13, 2014 the Shecter Committee published an interim report proposing: (i) the current regulatory regime shall not be amended until HOT's market share decreases to a rate that will be recommended later by the Shecter Committee; (ii) to reduce certain content demands on the multichannel broadcasters but not the size of the commitment to invest in local content; and (iii) to regulate certain special obligations of multichannel broadcasters that own infrastructure, taking into account the licensees' ownership of both the infrastructure and the services provided. The Shecter Committee has solicited additional responses from the public regarding its interim recommendations.

Broadband Internet Infrastructure Access and Fixed-Line Telephony

Overview

Our broadband internet infrastructure access and fixed-line telephony operations are subject to extensive legislative and regulatory requirements that apply to the telecommunications industry in Israel, including the Communications Law, and the regulations enacted in accordance with it. Our operations are subject to the supervision of the Israeli Ministry of Communications (the “Ministry”).

We provide our broadband internet infrastructure access, fixed-line telephony services and certain other communication services pursuant to a general domestic operator license for the provision of fixed-line services in Israel and a general license for provision of telecom services in several towns in Judea and Samaria (the “Fixed-Line Licenses”). Among other things, the Fixed-Line Licenses prohibit disconnection of any subscriber from the services other than in certain specified cases listed in therein. Our Fixed-Line Licenses are valid until 2023 and may be extended for periods of 10 years at a time upon approval by the Ministry. As a general rule, these Licenses are non-transferable. In addition, the transfer of means of control in the relevant license holders may be subject to prior approval of the Ministry.

Certain key features of the regulations and licenses governing our broadband internet infrastructure access and fixed-line telephony operations, including certain proposed regulatory changes that may have a significant impact on our operations, are set forth below.

Decision Regarding the Creation of a Wholesale Market

In February 2010, the Israeli Ministry of Communications (“the Ministry”) and Ministry of Finance appointed a commission headed by the former General Manager of the Israeli Ministry of Industry, Trade and Labor, Amir Hayek (the “Hayek Committee”), to review and make recommendations with respect to Bezeq’s retail telephony rates and the setting of rates for different segments with regard to provision of services in the broadband internet infrastructure access wholesale market. The Hayek Committee published its recommendations in October 2011. In May 2012, the Ministry published the final policy document on the subject of the expansion of the level of competition in the fixed-line communications field, which primarily adopts the recommendations made by the Hayek Committee.

On May 2, 2012, the Ministry published the final policy document on the subject of the expansion of the level of competition in the fixed-line communications field adopting the main recommendations made by the Hayek Committee in October 2011 with respect to the creation of a wholesale market for fixed-line communications. The Ministry adopted the following principles affecting the broadband internet infrastructure access market:

- In order to increase competition between providers of fixed-line communications services, owners of nationwide fixed-line access networks who also provide retail communications services (“infrastructure owners”), shall be obliged to sell wholesale services to communications license holders, who will provide services based on these infrastructures (“service providers”), including bitstream access, leasing of access elements (unbundling), leasing of dark fibers, duct access and transmission services (the “wholesale services”), on the basis of non-discriminatory terms.
- A service provider may issue a request to the infrastructure owners to make use of their network elements, including wholesale services. Service providers and infrastructure owners will conduct commercial negotiations to reach a usage agreement or provision of the aforementioned services, and immediately upon the signing of such an agreement, each infrastructure owner shall publish a reference offer. The reference offer will include the services that are included in the agreement between the infrastructure owner and the service provider, according to the tariffs and the terms set in the agreement, as well as other wholesale services, in accordance with a list that will be published by the Ministry from time to time, including an offered price for each service. An infrastructure owner shall not be allowed to offer volume discounts to a service provider. This offer will be offered to anyone who requests, on equitable and non-discriminatory terms, it will be available for perusal by any seeker, and will be presented on the website of the infrastructure owner, as well as on the website of the Israeli Ministry of Communications. For the purposes of this paragraph, an “agreement” means an agreement between an infrastructure owner and a significant service provider, which is not a related company to an infrastructure owner.
- Should the Minister of Communications (the “Ministry”) see that a tariff or a term was demanded by an infrastructure owner, or a tariff or a term was agreed to, for a wholesale service, which is not reasonable, may harm competition, may harm the public interest, or may harm the interests of a service provider, the Minister shall set that tariff or term. In the absence of a demand or an agreement on one or more terms or on a tariff, as stated above, the Minister shall set them, provided that an agreement has been signed or 6 months have passed since the issuance of this document, whichever shall come first, according to his authority under the Communications Law.

- The ancillary activities, services and arrangements to the wholesale services (rental of space, maintenance, etc.), arrangements for ordering, payment terms, and provisioning, and their tariffs shall also be set in commercial negotiations between service providers and infrastructure owners, and infrastructure owners shall be allowed to demand reasonable and equitable prices. In the absence of agreement between the relevant license holders, the Minister shall decide according to his authority under the Communications Law.
- The Israeli Ministry of Communications shall make use of a model for enforcement and supervision, which will help the Ministry ensure that the tariffs set in the reference offers are in accordance with the conditions set out above, and to monitor the actual provision of the wholesale services in a reasonable and non-discriminatory manner, and to track the level of implementation of the wholesale market.
- Infrastructure owners shall provide, on an on-going basis, information about ordering of wholesale services and the deployment of existing infrastructures, to other license holders, in accordance with the requirements of the Ministry and with exceptions that will be set by it.
- When a reference offer is published by an infrastructure owner, related corporations to that owner shall be allowed to purchase wholesale services in order to provide services according to the terms of their licenses, on the condition that such wholesale services are offered without discrimination to any seeker.
- When Bezeq publishes a reference offer, Bezeq shall be allowed to supply telephony services which are not provided over broadband networks, to its subsidiaries, in a wholesale arrangement. Should Bezeq decide to provide the aforementioned services, it shall provide them concurrently to any license holder who seeks them without discrimination, all subject to the relevant regulations regarding Bezeq subsidiaries.
- Within nine months of the publication of the reference offer, as described above, the Minister shall order the abolition of the structure separation between an infrastructure owner who published the reference offer, and providers of international calls and ISP services which are related corporations to that infrastructure owner, so that Bezeq, for example, will be allowed to provide to its subscribers bundles which are not disintegrable of all its services (local and international telephony, broadband internet access and ISP service), unless the Minister shall determine that in the situation of the wholesale market at that time, abolition of structural separation may cause significant harm to competition or to the public interest. Should the aforementioned structural separation be abolished, it will be replaced with accounting separation, in a format that will be set by the Minister.
- The Ministry shall set indicators or conditions under which the Minister may conclude that the level of development of the wholesale market and the level of development of competition based on bundles, including fixed and mobile services in the household sector, allows the granting of easements of the structural separation between an infrastructure owner and a radio telephone operator which is a related company, or the abolition of the said structural separation and its replacement with accounting separation.
- Should the Minister decide that the development of the wholesale market and the level of development of competition based on bundles of fixed and mobile services in the household sector allow it, the Minister shall consider the abolition of the structural separation between an infrastructure owner and a radio telephone operator which is a related company.
- The Minister shall review the matter of the disintegrability of television broadcasting services, included in service bundles which also include telecommunications services (whether fixed or mobile) or broadband internet services. The abolition of the structural separation between infrastructure owners and the multi-channel broadcasting sector will be done while providing a reasonable opportunity to provide a basic television broadcasting package on the internet by operators who do not have a fixed nationwide network.
- If the wholesale market will not develop in a sound and proper manner, according to indicators set for this purpose, within 24 months of the publication of this policy document, the Minister shall act to enforce structural separation between the infrastructure of a fixed domestic license holder and the services provided by that license holder to end users.
- Within six months of the publication of the reference offer, as described above, the Minister will act to change the tariff control mechanism over the tariffs of Bezeq, such that the control shall be exercised by setting a maximum tariff.
- The Ministry shall set, within nine months, a regulatory policy with the aim of increasing investment in, and upgrading the fixed communications infrastructure in Israel.

The Communications Law was amended in August 2013 in the following manner:

- The Minister's authority to determine payments under the law can include prices based on reference points (benchmark).
- The Minister may determine linkage payments by law based on indexes other than the CPI.
- To clarify the Minister's authority to obligate a license holder with respect to activities, services and ancillary arrangements related to interconnection or use of infrastructures.
- The Minister shall be authorized to issue instructions to immediately apply to a license holder for a limited period, if the actions of the licensee raise concern of immediate harm to competition, the public or the interests of another operator. The licensee will be given the opportunity to be heard as soon as possible, under the circumstances, after the instruction.
- The Minister may determine, with the consent of the Minister of Finance, the maximum or minimum charges for telecommunications services.
- The Minister may impose a structural separation between the infrastructure of a domestic operator and the services it provides to the end customers, if necessary.

Following publication of the policy document, on May 28, 2012, the Ministry of Communications initiated the establishment of an engineering forum, with the participation of the relevant telecommunications operators, which held a number of meetings regarding the wholesale services. In parallel, the company has conducted negotiations with various operators. Since in the Ministry's opinion the relevant time for conducting negotiations between the operators has elapsed, the issue has returned to the Ministry in order for a policy on the matter to be formulated.

On June 9, 2013, the Ministry published a hearing on the subject of the list of wholesale services for the shelf offer. HOT Telecom has submitted its position as part of the hearing. Furthermore, on June 19, 2013, the Ministry published a survey of retail costs in the form of a report defined by the Ministry. HOT Telecom has submitted its comments regarding the survey and the reporting format required.

On January 15, 2014, HOT Telecom received the decision of the Ministry regarding the list of wholesale services that the infrastructure owners (HOT Telecom and Bezeq) shall be obligated to offer to the suppliers of the services. In accordance with the decision, the list currently includes the following services:

- Managed bitstream access at the national connection level and at the regional or local connection level on the broadband internet route of the infrastructure owners.
- Dismantling into segments from the optical fibers/metal cable interface, as the case may be, and until the first socket in the end user's home (sub-loop unbundling). At this stage the service shall be offered in the Bezeq network only and not in the HOT Telecom network.
- Leasing dark fibers in the access network, the collection network and the core network.
- Leasing optical wavelengths (virtual dark fiber) in the core network.
- Access to the physical infrastructure of ducts, micro ducts, manholes, boxes and poles in the access network, the collection network and the core network.
- Retail telephony services.

In addition, the Ministry has published hearings regarding the provision of wholesale services (including regarding service file for bitstream access services at the national, regional and local level and the services files for use in passive infrastructures (dark fibers, manholes, ducts and above ground network)), and regarding the maximum tariffs for wholesale services in the Bezeq network, to which HOT Telecom submitted comments. Following the review of the positions submitted with respect to the service file for bitstream access services, and additional hearings published by the Ministry in February and August 2014, on November 17, 2014, HOT Telecom received a decision of the Minister regarding the regulation of wholesale services, including the method of setting wholesale services rates on fixed-line networks. According to the decision, after the hearing on this matter, the Minister adopted recommendations to amend infrastructure owners' licenses and determined the service files for broadband access and wholesale telephony services. The regulated services of the service files are to be provided within three to six months of the decision.

In addition, the decision included final maximum rates that can be collected for wholesale services by Bezeq from other license holders who make use of its infrastructure for the years 2014 to 2018. The decision stated that the Minister intends to have the draft regulations, and the rates contained therein, approved promptly by the Minister of Finance. HOT is currently assessing the impact of the decision, but, at this stage, is unable to anticipate the full effect on its business.

Implementation of Universal Service Obligations and Deployment of Fixed Lines

Similar to the Broadcasting Licenses, the Fixed-Line Licenses contain a requirement to extend our services to customers in all areas of Israel even where it would not be economically profitable to do so. Although we extend our services to most of Israel, there are currently certain areas of the country where we do not provide these services and we had applied for exemptions from the terms of the Fixed-Line Licenses. Pursuant to the Fixed-Line Licenses we are also required to provide network access service to other license holders on reasonable commercial terms so as to enable them to provide services to their subscribers and we must also avoid preferential provision of network access to our affiliated companies, including with regard to payment terms and service availability.

On June 22, 2014, a report (the "Report") was submitted to the Minister (the "Minister"), by an Advisory Committee to the Minister in accordance with the Communication Regulations (Telecommunications and Broadcasts) (Advisory Committee), 2011 (respectively, the "Committee" and "Regulations") recommending the considerations that should be applied in relation to applications submitted by Bezeq and HOT Telecom for exemption or deferral of the obligation to extend service. Amongst other things, the Committee recommended that there should be no justification to delay or limit the provision of telecommunications services in any area nationwide on the basis of cost-benefit considerations. The Report concludes that cost-benefit considerations should be taken into account only for applications to specifically restrict or deny the provision of communications services to specific customers (an "Individual Application"), rather than for a specific area or number of requests from the same area (a "General Request").

The Committee also recommended that limitations on the provision of communication services through exemptions or deferrals should, as a rule, be done only temporarily and recommended a temporary exemption for a fixed period of 24 months. It also recommended license holders must report any change in the circumstances surrounding an application for which an exemption was approved, and if the circumstances upon which the exemption was based no longer exist the universal obligation upon the licensee will apply immediately and without delay. In addition, the Committee recommended certain timelines for the implementation of the universal service obligation in case of rejection of an application for exemption or deferral.

The Committee further recommended the rejection of all existing applications made by HOT Telecom, except with regard to one specific application relating to a particular settlement for which it suggests a deferral for a period of 24 months, subject to the provision of an alternative solution by HOT Telecom.

On July 17, 2014, HOT Telecom filed its detailed response to the Committee's recommendations to the Minister of Communications.

On November 16, 2014, the Minister of Communications published his decision to adopt the recommendations of the Committee. As part of that decision, the Minister accepted the Committee's recommendations with respect to the rejection of all existing applications for deferral and/or exemption made by HOT Telecom (subject to the exception noted above). As a result, HOT is required to implement its universal service obligations with respect to the first stage of the deployment, in 60 local jurisdictions determined by the Minister, within 24 months from the date of the adoption of the Committee's recommendations. As noted above, the prescribed pace of implementation of the obligations will be reviewed annually, taking into account any technological and regulatory changes. It was further decided that the Committee shall submit to the Minister of Communications a list of recommended local jurisdictions for the next deployment stage, if required in accordance with the then-available technological alternatives.

In addition, in his decision the Minister applied to the Judea and Samaria Communications Headquarter Officer requesting that the Civil Administration act in order to adopt the Committee's recommendations in the areas of Judea and Samaria, and the Minister instructed the Ministry of Communications to prescribe regulations that will impose the obligation to offer its services in the areas of Judea and Samaria on the broadcasting company.

HOT is currently unable to estimate the full impact of the Minister's decision on its business, but expects that implementation may have a negative impact on its results given that it will be required to expend additional capital expenditure for which it does not expect to derive a commensurate gain.

Hearing regarding "margin squeeze"

On November 17, 2014, the Ministry of Communications published a hearing regarding the creation of a process to examine the potential use of "margin squeeze" by owners of fixed telecommunications infrastructure. The purpose of the

hearing is to examine whether fixed infrastructure owners engage in the practice of lowering retail price offerings in order to reduce the margin between retail prices and the wholesale price of using infrastructure for service providers who do not own fixed infrastructures. The consequence of this is the erosion of profitability for such service providers and their eventual exclusion from the market.

It is proposed that HOT and Bezeq will be required to provide the Ministry of Communications with every retail offer they intend to make to new or existing subscribers, and that the Ministry may notify the infrastructure owner, if there is a concern over “margin squeeze,” that it is forbidden to offer the proposed package. HOT has been given the opportunity to respond and is currently studying the terms of the hearing. At this stage, HOT is unable to fully evaluate the consequences of the proposals on the Company.

Removal of Certain Restrictions on Bezeq

In 2010, following the reduction in the market share of Bezeq, the incumbent telephony services provider in Israel, in the field of land-based communications below 85%, the Israeli Ministry of Communications announced that it was amending the licenses granted to Bezeq and its subsidiaries thus enabling it to commence marketing multiple-play packages to residential customers and allowing it to market its ISP and fixed-line telephony and broadband internet infrastructure access services together. To the best of our knowledge, Bezeq currently markets two communications multiple-play packages which include: (i) internet infrastructure access services (ADSL) as well as ISP services from subsidiary Bezeq International; and (ii) internet infrastructure access services (ADSL), ISP services from subsidiary Bezeq International as well as fixed-line telephony services. Bezeq also recently began to market bundles including its fixed-line domestic services (both telephony and broadband internet infrastructure access) with mobile services provided by its subsidiary, Pelephone. Bezeq has recently been permitted to provide multiple-play packages to business customers as well. However, Bezeq will not be permitted to discriminate with its internet infrastructure access services prices between a subscriber that uses the service together with telephone service and a subscriber that only uses the internet infrastructure access service.

Based on publicly available sources, Bezeq has filed a merger notice with the Israeli Antitrust Commissioner, regarding its proposed merger with YES. Based on publicly available information disclosed by Bezeq and the Israeli Antitrust Authority, the Israeli Antitrust Commissioner has published, on March 26, 2014, the new conditions for the approval of the merger between Bezeq and YES. The main conditions are as follows:

1. Bezeq will not set any limitation on internet services consumption, based on the customer’s volume usage, including setting the price or quality of service in accordance with the customer’s volume usage;
2. Bezeq will deduct from ISPs payments for GIGA connections the charges that stem from IPTV usage. For that purpose, the IPTV usage will be calculated by the number of TV subscribers reported by the IPTV provider multiplied by a 2 Mbps bandwidth;
3. Bezeq will not limit or block the customer’s ability to use any service or application on the internet at any time, directly or indirectly, including by way of pricing or by technological means;
4. Bezeq’s TV services will be sold and provided under equal terms to all Bezeq customers, whether they purchase additional services from it or not. The TV price in the bundle will be presented separately from the other services. Bezeq’s internet services will also be provided under equal terms to all its customers, whether they purchase additional services from it or not; and
5. Bezeq and YES will cancel all exclusivity agreements except original local productions, and shall not be parties to such agreements anymore. Furthermore, from the merger approval date and for a period of 2 years, Bezeq shall not prevent any party, except broadcasting license holders at the date of the decision, to purchase rights in original local productions. This provision shall not apply to news productions.

Israel Electric Company Infrastructure

In 2010, the Israeli Ministry of Communications (the “Ministry”) announced that in order to leverage the existing infrastructure owned by the Israeli Electric Corporation (a government owned company and the principal owner of the electric transmission and distribution network in Israel), with a view to increasing competition in the fixed-line telephony and broadband internet infrastructure access market, it intended to grant a license to a joint venture between the Israeli Electric Corporation (the “IEC”) and a private-sector partner pursuant to which such joint venture would be permitted to provide various communication services, including wholesale products to other telecommunication licensees and fixed-line telephony and broadband internet access to large business customers. The procedure to select the private sector partner to the Israeli Electric Corporation has also been initiated.

In June 2013, the committee for selecting an investor and a controlling shareholder in the joint communication project with the IEC announced that it chose a group of investors for the foundation of a communication venture designed to establish a network based on fiber optics, headed by Via Europe which holds 60% of the venture, along with the IEC which holds 40%.

On August 27, 2013, the Minister granted a general license to provide inner-country telecommunications services (Infrastructure) to I.B.C Israel Broadband Company (2013) Ltd. (hereinafter "IBC"). The permit requires IBC to set up a nationally deployed fiber-optics-based communication network, in accordance with the milestones set out in the license, additionally to the license to provide domestic wired telecommunications services through it to other license holders. IBC was also granted by the Ministry, on that date, to the best of the company's knowledge, a special license to provide a domestic wired data communications services which allows it to provide services to large business customers, with annual revenue of minimally NIS 30 million, as well as to government agencies and local authorities.

On May 27, 2014, the Minister of Communications announced the creation of an inter-ministerial committee headed by the Director General of the Ministry and attended by senior representatives from the Ministry of Interior, Ministry of Finance, Ministry of Justice, and the Energy and Water Resources Minister of Israel. The purpose of the committee is to discuss adopting regulation to enable IBC deploy an enterprise optical fiber infrastructure and remove barriers to entry in that sector.

We believe that the granting of such licenses could result in increased competition in the domestic wired telecommunications services sector and thus significantly affect the results of HOT. HOT's assessment by its nature is forward-looking information and may differ significantly from actual results due to factors outside of HOT's control.

Telephony Services over Broadband Internet

In 2007, the Israeli Ministry of Communications published the licensing policy for the provision of telephony services via broadband internet infrastructure or Voice Over Broadband. The policy stipulated that the provision of Voice Over Broadband services will be regulated via general specific licenses to be granted pursuant to the provisions of the Communications Regulations (Telecommunications and Broadcasting) (Processes and Conditions for Receipt of a General Specific License), 5764-2004. A general specific licensee will be permitted to provide telephony services using VoIP or VOB technology via the broadband internet infrastructure access service of a general fixed-line licensee (currently only us and Bezeq). This policy thus permits a general specific licensee to provide services using a broadband licensee's network without the requirement to pay the owner of the network infrastructure charge, although they still must pay interconnection fees, whilst competing with it in providing fixed-line telephony services.

Elimination of Gigabit Ethernet Transmissions Fees

In the Israeli broadband internet market, the broadband internet infrastructure access providers, Bezeq and us, receive payment from subscribers for access to the infrastructure and from ISPs for the Gigabit Ethernet (GBE) connections used as part of the connection to the internet. On June 26, 2012, the Israeli Ministry of Communications announced a hearing and request for comment on the subject of GBE connections for ISPs. The proposal was issued in light of the expectation that the use of the television broadcasting services via the open internet network (OTT) will increase, thus increasing the need for internet bandwidth. In order to ease the entry of additional players into the broadcasting field through OTT, the Israeli Ministry of Communications is considering changing the service files which describe the fee structure charged with respect to the broadband internet access services provided to customers, so that such fees and services include all of the components that are required to provide the connection speeds for the purchasers of the service, including the carrying of traffic on the access and core networks. Thus, the proposed legislation would eliminate the payments that are currently paid to the owners of the infrastructure by the ISPs for the GBE connections, other than the transmission from point-to-point segment which connects between the networks of the owners of the infrastructure and the facilities of the ISPs and which may be purchased from the owners of the infrastructure or from one of the other appropriate license holders, who provide GBE transmissions. It was also proposed that the owners of the infrastructure maintain a minimum number of connection points on the basis of geographic regions and regulate the ability of the ISP to select a certain number of connection points. The proposal also provides that the owners of the infrastructure will be required to provide GBE connections at a certain rate based on the aggregate connection rate that has been ordered by the subscribers of that ISP. The GBE proposal could reduce the revenue our broadband internet infrastructure access segment receives as a result of the prohibition on charging ISPs for the GBE connections.

Fees and Royalty Payments

The regulations enacted under the Communications Law obligate HOT Telecom to make royalty payments to the State of Israel in connection with its domestic fixed-line operator license. These royalty payments were reduced to zero in January 2013.

Internet Service Provider

We provide our ISP services through our subsidiary, HOT Net, pursuant to a special license to provide internet access services (the "ISP License"). The ISP license permits us to provide various services, including internet access services, email services, installation and maintenance of a network for transmission of data, documents and electronic messages (EDI), processing, management and routing of messages and system administration services (including monitoring and handling malfunctions, information security, information systems and information compression and securing access to service recipient's computer). Under the terms of the ISP License, we are required to provide ISP services to any customer or other ISP license holders, including to customers of other broadband internet infrastructure access providers, without discrimination and under identical terms and conditions. Our ISP License is valid until December 31, 2015, and may be extended upon approval by the Israeli Ministry of Communications (the "Ministry"). As a general rule, the transfer of any means of control in a relevant license holder is subject to prior approval of the Ministry. On October 31, 2012, the Ministry published an amendment applicable to all licenses issued to ISP providers including our ISP License. The amendment introduced certain provisions mainly relating to consumer protection.

Mobile

Our mobile operations are subject to the Communications Law, the Telegraphy Ordinance New Version, 1972, and the regulations enacted in accordance with them. We are also subject to the Planning and Construction Act and regulations with regard to site construction, the Consumer Protection Law, 1981, the Non-Ionising Radiation Law and the Law for the Prevention of Environmental Hazards (Civil Claims), 1992, which enables class action claims in cases of radiation contamination. We provide our mobile services pursuant to a non-exclusive license to erect, maintain and operate a mobile system and to provide mobile services (the "Mobile License"). The Mobile License was amended in September 2011 to add additional frequencies in relation to the creation of a UMTS network. The Mobile License with respect to the main original frequencies which we use to deliver our iDEN-based mobile services is valid until February 2016. The Mobile License with respect to the additional frequencies which we will utilize to provide UMTS-based mobile services is valid until September 2031. The Mobile License may be extended for periods of six years at a time upon approval by the Israeli Ministry of Communications (the "Ministry"). As a general rule, the Mobile License is non-transferable, and the transfer of any means of control in a relevant license holder is subject to prior approval of the Ministry.

Certain key features of the regulations and licenses governing our mobile operations, including certain proposed regulatory changes that may have a significant impact on our operations, are set forth below.

On July 2, 2014, the Ministry published a tender for a mobile phone license for the provision of advanced services using 4G-LTE technology, through which a total of eight frequency bands in the area of 1,800 MHz will be allocated (with a width of 5 MHz). On November 18, 2014, HOT Mobile submitted its offer in response to the tender.

The draft tender clarified that a licensee may enter into a network sharing agreement with another licensee subject to certain conditions. As a result, HOT Mobile has updated its request for approval by the Ministry of the Joint Network Agreement with Partner accordingly.

In connection with this tender process, the Ministry announced its decision to allow all existing mobile operators wishing to upgrade their systems immediately to use the frequency bandwidth of 5 MHz (X2) in the area of 1,800 MHz LTE technology. If the operator does not currently have such an allocation, the Ministry will assign them a temporary frequency bandwidth to use LTE technology until the end of the tender proceedings. However, companies will be required to avoid discrimination between operators that are being hosted on their networks, such as virtual operators or operators with domestic roaming agreements, in terms of the level of technology offered to their subscribers. In addition, companies will not be able to discriminate between subscribers with regards to the price of services, and will not be able to charge an additional cost for these 4G services, until such time as the launch of LTE after the publication of the tender winners and receiving their revised frequencies license. Companies may also not raise fares in light of this upgrade to customers, virtual operators or users of domestic roaming. During July and August 2014, Partner Communications Ltd., Cellcom Israel Ltd. and Pelephone Communications Ltd., announced the launch of LTE. HOT Mobile intends to launch such services in the coming months. The outcome of the 4G- LTE tender process is provisionally expected to be announced during the first quarter of 2015.

Further, in connection with the tender, Golan Telecom and HOT Mobile may request to replace the deployment plan they attached to the tender for the UMTS frequencies with a deployment plan for 4G, provided investment in the 4G network is equivalent to investment in the original deployment plan they committed to, and that they will only use frequencies assigned to them in the 4G tender for the provision of 4G services.

On January 12, 2015, the Israeli Ministry of Communications informed HOT Mobile that based on the results of the tender it would be awarded a frequency bandwidth of 2X5MHz in the 1.8 GHz spectrum, for a license fee of NIS 34.5 million (up to half of which may be paid by way of provision of a bank guarantee, which may be refunded, in whole

or in part, upon HOT Mobile reaching certain market share milestones). The tender results will be brought before the Minister of Communications for approval.

Construction of Network Sites

The regulation of network site construction and operation are primarily set forth in the Israeli National Zoning Plan 36A for Communications which was published in May 2002 ("National Zoning Plan 36"). The construction of radio access devices, which are cell sites of smaller dimensions, is further regulated in the Planning and Building Law and the Communications Law.

National Zoning Plan 36A

National Zoning Plan 36A (the "Plan") includes guidelines for constructing cell sites in order to provide mobile broadcasting and reception communications coverage throughout Israel, while preventing radiation hazards and minimizing damage to the environment and landscape. Plan sets forth the considerations that the planning and building authorities should take into account when issuing building permits for cell sites. These considerations include the satisfaction of safety standards meant to protect the public's health from non-ionizing radiation emitting from cell sites, minimizing damage to the landscape and examining the effects of cell sites on their physical surroundings. However, the Plan is in the process of being revised. Current proposed changes will impose additional restrictions and requirements on the construction and operation of cell sites. On June 1, 2010, the National Council for Planning and Building approved the National Zoning Plan No. 36/A/1 version that incorporates all of the amendments to the Plan (the "Amended Plan"). The main amendments to the Plan are: (a) the Amended Plan provides for full liability for depreciated property claims on the mobile operators; (b) the Amended Plan prohibits the erection of poles in urban areas (excluding industrial zones) and in rural areas (excluding next to existing infrastructure); (c) the Amended Plan grants to the municipalities the authority to approve local zoning plans that will regulate the deployment of site; and (d) the Amended Plan demands a minimum distance of four meters between antenna poles on a rooftop.

The Amended Plan is subject to governmental approval, in accordance with the Planning and Building Law. It is unknown if, and when, the government intends to approve the Amended Plan. If the Amended Plan is approved, it may have a significant impact on our ability to get permits for our mobile sites. In addition, we may need to change the location of our future mobile network sites to less suitable locations, which may have an adverse effect on the quality and capacity of our mobile network coverage. The cost of complying with the Amended Plan might be substantial and may adversely affect our revenues and profits. The Amended Plan has not yet received the required approval.

Radio Access Devices

Most mobile operators have historically relied on an exemption from obtaining a building permit under the Construction and Planning Law for constructing rooftop mobile radio access devices, which was consistent with the Israeli Attorney General opinion on the matter. In May 2008 the District Court of Tel Aviv- Jaffa, in its capacity as court of appeals, ruled that mobile operators' devices do not meet the exemption's requirements and therefore the exemption may not be relied upon. An appeal was filed against this ruling to the Supreme Court and the Israeli government notified the Supreme Court that it concurs with the appeals against the District Court ruling. Furthermore, in July 2008, a petition seeking to annul the Attorney General's opinion and apply the District Court ruling was filed with the Supreme Court by the Union of Local Authorities in Israel and certain local planning and building authorities which also requested to join our appeal and argue against the position of the State. In June 2009, another petition seeking similar remedies was also filed with the Supreme Court. The Supreme Court decided to hear both petitions and our appeal together. In September 2009, following publication of the recommendations of an inter- ministry committee established to examine the appropriateness of the future application of the exemption, the Attorney General concluded that the application of the exemption does not balance properly the different interests involved and therefore cannot continue. In March 2010 draft regulations were issued setting conditions for the application of the exemption, which include significant limitations on the ability to construct radio access devices based on such exemption, including a limitation of the number of such radio access devices to 5% of the total number of cell sites constructed or to be constructed with a building permit in a certain area during a certain period (which will render the construction of radio access devices based on the exemption practically impossible), and circumstances in which a request for a building permit for the radio access device was filed and no resolution has been granted within the timeframe set in the regulations. In September 2010, the Supreme Court issued an interim order prohibiting further construction of radio access devices in mobile networks in reliance on the exemption. The interim order, that was issued pursuant to the Israeli Attorney General's request, will be in effect until the enactment of the proposed regulations or other decision by the court. A further decision of the Supreme Court in February 2011, states that the order will not apply to the replacement of existing radio access devices under certain conditions. In September 2010, pursuant to the Israeli Attorney General's request, the Supreme Court issued an interim order prohibiting further construction of radio access devices for mobile networks in reliance on the exemption mentioned above. In September 2011, the Supreme Court permitted HOT Mobile and Golan Telecom to use the exemption in order to erect their new UMTS networks until July 31, 2011 (subsequently extended several times, most recently on

September 30, 2013), provided, however, that no more than 40% of the facilities that the operator erects are within the jurisdiction of any municipality, an affidavit is submitted in advance to the municipality's engineer and the safety zone does not exceed four meters and does not deviate from the boundaries of the lot.

The Supreme Court has given an order nisi in the petitions. The State replied to the petitions arguing that a perpetual injunction should be awarded by the court preventing the erection of access devices until the completion of legislation of the regulation by the Ministry and Ministry of Interior. The State also replied that the exemption for the erection of access devices for HOT Mobile and Golan should last until June 30, 2014. Until a final decision has been made by the Supreme Court, HOT Mobile will be allowed to continue the deployment of its UMTS network. If this exemption is not extended by the Supreme Court, we will have to seek permits, which could result in substantial delays and costs and, as a result, we may be unable to meet our license requirements.

Radio access devices also require permits from the Israeli Ministry of Environmental Protection. The local planning and building committee's engineer may object to the exemption for a permit requirement prior to installing radio access devices. An annulment of, or inability to rely on, or substantial limitation of, the exemption could adversely affect our existing network and network build-out (particularly given the objection of some local planning and building authorities to grant due permits where required), could have a negative impact on our ability to obtain environmental permits for these sites, could negatively affect the extent, quality, capacity and coverage of our network and have a negative impact on our ability to continue to market our mobile services effectively.

Indemnification Obligations

In January 2006, the Planning and Building Law was amended to provide that as a condition for issuing a building permit for a cell site, local building and planning committees shall require letters of indemnification from mobile operators indemnifying the committees for possible depreciation claims under Section 197 of the Planning and Construction Law, in accordance with the directives of the National Council for Planning and Building. Section 197 establishes that a property owner whose property value has depreciated as a result of the approval of a building plan that applies to his property or neighboring properties may be entitled to compensation from the local building and planning committee. In February 2007, the Israeli Minister of Interior Affairs extended the limitation period within which depreciation claims may be brought under the Planning and Building Law from three years from approval of the building plan to the later of one year from receiving a building permit under National Zoning Plan 36 for a cell site and one year from the construction of a cell site. The Minister retains the general authority to extend such period further. This extension of the limitation period increases our potential exposure to depreciation claims.

The Non-Ionizing Radiation Law

The Non-Ionising Radiation Law prohibits the construction and operation of cell sites without a permit from the Israeli Ministry of Environmental Protection. The Commissioner of Environmental Radiation, or the Commissioner, is authorized to issue two types of permits: construction permits for cell site construction, and operating permits for cell site operation. These permits contain various conditions that regulate the construction and operation of cell sites. A construction permit is valid for one year (and will allow us to operate a cell site for a period not exceeding three months), and an operating permit will allow us to operate a cell site for a period of five years. We are required to submit to the Commissioner annual reports regarding radiation surveys conducted on our cell sites and other facilities by third parties that were authorized to conduct such surveys by the Commissioner. In order to receive an operating permit from the Commissioner, certain conditions must be met, such as presenting a building permit or an exemption and means taken (including technological means) to limit exposure levels from each cell site or facility (relevant also for the receipt of a construction permit). The Non-Ionising Radiation Law, grants the Commissioner authority to issue eviction orders if a cell site or other facility operates without complying with its permit, and it imposes criminal sanctions on a company and its directors and officers for violations of the law. Failure to comply with the Non-Ionising Radiation Law or the terms of a permit can lead to revocation or suspension of the permit, as well as to withholding the grant of permits to additional cell sites.

The Ministry of Environmental Protection notified us of a new condition for all of our mobile network site operation permits in order to receive operating permits, according to which we must connect to a monitoring system of the Ministry of Environmental Protection that continuously monitors and reports the level of power created in real time from the operation of our mobile network sites.

Since May 2012, we started erecting our new UMTS cell sites according to construction permits received in November 2011. We have also made practical examinations of all our new UMTS cell sites. All of the examinations showed that our new UMTS cell sites comply with the safety standard determined by the Ministry of Environmental Protection. As of August 2012, we began to apply for operation permits to our sites to the Commissioner. We also applied for extended time to connect to the monitoring system to the commissioner. As of November 2012, we started receiving operation

permits. On February 4, 2013, we were notified by the Ministry of Environmental Protection that we have complied with all of its requirements for connecting to the monitoring system.

Prohibition of Exit Fee

On March 21, 2012, the Knesset passed an amendment to the Communications Law in order to prohibit a license holder from collecting an exit or termination fee from new subscribers who cancel their agreement with the license holder. A license holder is still permitted to collect the balance of payment owed to it by the subscriber relating to the purchase of end-user equipment. The amendment does not apply to large subscribers who have purchased 100 or more lines. Additionally, under the terms of the amendment, as of January 2013, it is not possible to link a transaction for the purchase of end-user equipment and the provision of mobile services.

Mobile Virtual Network Operator

A mobile virtual network operator, or MVNO, is a mobile operator that does not own its own spectrum and does not have its own radio network infrastructure. Instead, MVNOs have business arrangements with existing mobile operators to use their infrastructure and network for the MVNO's own customers. The Communications Law was amended in July 2009 to provide for MVNO licenses, and, in January 2010, the regulations necessary for the granting of an MVNO license were promulgated. The regulations regulate the operation of an MVNO pursuant to an agreement to be reached and entered between a mobile operator and an MVNO and sets, among others, the conditions for receiving an MVNO license, including a requirement to operate a mobile phone switch, a restriction on a mobile operator and a fixed-line operator to receive an MVNO license and limitations on parties related to an existing mobile operator and on other communication licensees to receive an MVNO license. The amendment provides that in the event that an, MVNO and mobile operator will not have reached an agreement as to the provision of service by way of MVNO within six months from the date the MVNO has approached the mobile operator, and if the Ministry together with the Israeli Ministry of Finance determine that the failure to reach an agreement is due to unreasonable conditions imposed by the mobile operator, the Ministry will use its authority to provide instructions. Such instructions may include intervening in the terms of the agreement, including by setting the price of the service. To date the Ministry has granted nine MVNO licenses.

Fees and Royalty Payments

In accordance with our Mobile License, we were required to pay to the State of Israel a total license fee of NIS 705 million, out of which we paid NIS 10 million at the time of receiving the license. We then provided a bank guarantee to the State of Israel for the remaining NIS 695 million. As of the first testing date on September 26, 2013, we achieved a market share calculated in accordance with the license agreement that entitled us to a deduction of the entire amount of the NIS 695 million license fee outstanding. Accordingly, we requested the Ministry to reduce the amount of the bank guarantee to an amount of NIS 80 million as guarantee of our obligation to achieve certain territorial coverage requirements under our license. On November 21, 2013, the Ministry notified HOT Mobile that the license fees were to be decreased to NIS 10 million (which has already been paid) and the bank guarantee shall be decreased from the amount of NIS 695 to an amount of NIS 80 million. See "*Description of Our Business—Material Agreements—Provision of certain bank guarantees to the State of Israel relating to performance of certain license terms*".

Reduction of Interconnection Fees

Effective December 1, 2013, interconnection fees between fixed-line telephony service providers (including Bezeq, VoIP or VOB providers and us) were reduced by 60% and set at NIS 0.01.

Copyright/Trademark Law

Israel grants copyright protection to original literary, dramatic, musical and artistic works, as well as sound recordings and computer programs under the Copyright Law, 5767-2007. Copyright protection automatically exists with respect to works which comply with the terms set forth in the Copyright Law. Under the Copyright Law, generally, protection of a work runs from the date of creation until the end of the seventieth year after the year of the death of the author. Israel is party to a number of multinational treaties relating to copyrights, including the Berne Convention.

In Israel, trademarks are governed by Trade Marks Ordinance (New Version), 5732-1972. A trademark registration is valid for 10 years from the date of the trademark application. The registration may be renewed for further periods of 10 years after each renewal. The legal protection of a trademark is conditioned on it having distinctive character. Israeli law also provides for legal protection to unregistered trademarks. Under the Trade Marks Ordinance an owner of a trademark that is well-known in Israel can exclude others from using the mark, even when the trademark was not registered in Israel. Israel is also party to a number of multinational treaties relating to trademarks.

Structural Separation

In order to promote competition in the telecommunication and broadcasting industry in Israel the various licenses issued to us to conduct our business contain provisions that require us to maintain strict structural separation between the HOT group entities that hold the licenses, including separation of assets, management and employees. As a result, we generally operate our cable television services which are subject to the Broadcasting Licenses, our broadband internet infrastructure access and fixed-line telephony services which are subject to the Fixed-Line Licenses, our ISP services which are subject to the ISP License and our mobile services which are subject to the Mobile License as separate businesses conducted by separate entities within our Group. In addition, pursuant to the license provisions, our cable network assets are owned by HOT Telecom and access to the network is provided to other HOT entities pursuant to certain inter-company arrangements and subject to legal requirements. Under the terms of the licenses, we are also prohibited from making any of our services conditional upon subscription to another service. For example, we are not allowed to force customers to opt for our multiple-play packages and must continue to offer our various services on a stand-alone basis. However, notwithstanding the requirement to maintain such structural separation, we are permitted to offer our customers multiple-play services and conduct related marketing, billing and collection activities of our pay television, broadband internet infrastructure access and fixed-line telephony on the condition that only commercial information necessary for marketing, billing and collection activities of our multiple-play services are shared between the relevant HOT entities.

On December 9, 2013, the Knesset Finance Committee approved the bill for promoting competition and reducing concentration. According to the bill, a committee will be established with the objective to supervise the attempts to limit concentration, headed by the Antitrust Commissioner and hosting members such as the General Director of the Ministry of Finance and the head of the National Economic Council or one of his deputies appointed by the prime minister. Under the bill, among other things, the regulator may decide not to assign any right, including the right to grant or extend a license, to a concentrated factor as it is defined in the bill, if it finds that it is unlikely that any real harm may be caused to the sector in which this right is assigned and the regulation of such sector. Also, a regulator seeking to allow the assignment of a right, including the grant or extension of a license, will not do so, including not allowing any concentrated factor to participate in the assignment procedure of this right and not setting any conditions that allow its assignment, but only after taking into account considerations of cross market concentration in consultation with the entity in charge of the concentration reduction. In addition, the bill provides, *inter alia*, that when assigning a right and setting its terms the regulator must consider, in addition to any other vital consideration as specified by law, considerations of promoting competition in the sector, and, if the right is included in the list of rights issued by the Antitrust Commissioner in this regard, the regulator may assign this right only after considering promoting competition in the sector in consultation with the Antitrust Commissioner. Under the bill, the holder of a general license to broadcast through cables is defined as a concentrated factor. On October 16, 2013, the Ministry published a hearing regarding a recommendations report of an inter-departmental team aimed at examining the current regulations in the international telecommunication services sector, and the need to modify it in light of developments and changes in the telecommunication market. The ministry allowed such license holders and all relevant parties to submit their position regarding the hearing until December 1, 2013. On August 14, 2013, the Ministry published a hearing by which the Ministry began formulating a new regulatory framework, in which a version of one unified license will be determined, by which it will be possible to provide all the services provided today with a special general license for providing domestic wired telecommunication services, a license to provide radio mobile phone services through another operator, and a general license to provide international telecommunications service. The unified licensing framework will also enable the license holder to provide internet access services (ISP) and NTP. HOT Telecom submitted a response with respect to the hearing. In November 2014, the Minister of Communications approved the unified licensing framework.

Consumer Protection and Regulatory Bills

On July 24, 2014, an amendment to the Consumer Protection Law (effective from January 1, 2015, subject to regulations to be issued up to that date) was enacted permitting certain means of administrative enforcement against violations of the Consumer Protection Act, including monetary sanctions (including sanctions for both continuing and recurring violations), warnings and commitments to avoid a breach. The amendment also granted the Commissioner of Consumer Protection with the power to investigate breaches, certify inspectors and make administrative orders.

Further to such amendment, on August 18, 2014, the Council and the Ministry published hearings regarding proposed amendments to the licenses of HOT and other communication operators, including fully-owned subsidiaries of HOT. It is proposed that licenses will be amended to both add, and strengthen, requirements with respect to the quality of service provided by the service centers of the license owners, including, *inter alia*, with respect to maximum response and average daily response times, hours of operation, obligations to record calls and obligations to publish on the license-owners' websites detailed weekly reports regarding such response times. HOT has submitted its response to the hearings. In parallel, the Ministry of Communications has published a bill to amend the Communication Law to provide that, should a license holder fail to comply with the terms of its license with regard to the proposed amendments relating to response times, a subscriber may claim financial compensation at a fixed price without having to prove any damage.

At this stage, HOT is unable to estimate the influence of the amendments, if implemented as currently proposed, on the company's operations and financial performance.

French Overseas Territories

Our business activities in the French Overseas Territories are subject to the specific legislation and regulations of both France and the European Union governing the telecommunications sector and the information society.

Regulation of Electronic Communications Networks and Services

The European Regulatory Framework for Electronic Communications

The majority of the regulatory provisions applicable in France to the telecommunications sector are set forth in the French Code for Postal and Electronic Communications Code (*Code des Postes et des Communications Electroniques* (the "CPCE")).

In addition, the following texts are also applicable to the telecommunications sector:

- Regulation (EC) No. 2887/2000 dated December 18, 2000, on unbundled access to the local loop, which provides that all operators with significant market power must offer unbundled access to their local loop and associated facilities under transparent, fair and nondiscriminatory conditions;
- Regulation (EC) No. 717/2007 on roaming on public mobile telephone networks within the European Community, amended in 2009 by Regulation (EC) 544/2009 dated as of June 18, 2009, and in 2012 by Regulation (EC) No. 531/2012 which provides that all wholesale and retail roaming charges levied by mobile operators are subject to price caps which are set until June 30, 2017;
- Regulation (EC) 1211/2009 dated November 25, 2009, establishing the Body of European Regulators for Electronic Communications (the "BEREC"). Rather than operating as a European regulatory agency, the BEREC's role is to act as a forum for cooperation between the national regulatory agencies ("NRAs") and the Commission. Its responsibilities include developing and relaying guidelines and regulatory best practices to NRAs as well as issuing reports and opinions to the European Commission, Parliament and Council;
- Decree 2012-513 dated April 18, 2012, concerning the reporting of information to the public authorities on infrastructure and networks set up in their areas. This decree sets down a procedural framework and lists the type of information that operators are required to provide to local government agencies; and
- Decree 2012-1266 dated November 15, 2012, relating to safety and integrity controls for the equipment, networks and services of electronic communications operators. This decree provides that the French government may carry out audits and controls on the safety and security of operators' networks.

French Regulatory Framework Applicable to Electronic Communications

Authority of the ARCEP

In France, the national regulatory authority (NRA) for electronic communications is the ARCEP. We must declare our activities and register with the ARCEP.

Until recently, the sanctions available to the ARCEP if an operator failed to comply with the regulatory framework, as set forth in Article L.36-11 of the CPCE, included limiting the scope or reducing the term of the operator's registration, as well as suspending or even fully withdrawing such registration. It could also impose fines representing up to 3% of the operator's annual revenue, or 5% in the event of a repeated breach. In the case of a serious and immediate infringement of the rules, it also could order precautionary measures without any requirement of prior notice. In addition, if an infringement could cause serious harm to an operator or the market, the ARCEP's Chairman could make an emergency application to the French *Conseil d'Etat* for an order requiring the party concerned to comply with the applicable rules and impose a daily fine until such party complies. On July 5, 2013, however, the *Conseil constitutionnel* invalidated the power of sanction of the ARCEP set forth in Article L. 36-11, paragraphs 1 through 12, of the CPCE. An ordinance dated March 12, 2014, has restored the power of sanction of the ARCEP and henceforth complies with the principle of separation of investigative and sanctioning powers.

Market Analysis—Asymmetric Regulation

The analysis of markets is the cornerstone of the asymmetric regulation framework applicable to operators that occupy a dominant market position.

The first and second phases of such market analysis were completed by the ARCEP at the end of 2007 and 2010, respectively. The market analysis was carried out in three distinct markets: the fixed-line market, the mobile market and the broadband internet market. From 2010 to 2012, the ARCEP carried out and completed the third phase of its market analysis, covering the period from 2011 to 2014.

The regulatory measures that can be imposed by ARCEP on operators identified as having significant market power in a relevant market (and, as applicable, on another market of the electronic communications sector that is tightly linked to the aforementioned market) are specified in Articles L. 38, L.38-2 (wholesale markets) and L. 38-1 (retail markets) of the CPCE.

We are not presently considered by the ARCEP to be an operator identified as having significant market power in any relevant market except, like any other operator, in the market of calls terminating on our network (ARCEP Decision No. 2010-1149 dated November 2, 2010). This implies that we must comply with the regulations applicable to call termination charges on landline networks.

The regime governing the call termination charges has recently been changed. Since January 1, 2013 the call termination charge applied by operators is set at €0.008.

We cannot guarantee that we will not, in the future, be identified by the ARCEP as having significant market power in one or several other relevant markets and that the ARCEP will not impose additional regulatory measures on us.

Symmetric Regulation

The ARCEP also regulates in a “symmetric” way, i.e. by imposing the same obligations on all operators through a number of decisions, for instance:

- Decision 06-0639 dated November 30, 2006, on supplying subscriber lists for the purpose of publishing universal directories;
- Decision 07-0213 dated April 16, 2007, on routing communications used for value added services;
- Decision 2009-0637 dated July 23, 2009, on portability; and
- Decision 2009-1106 dated December 22, 2009, and decision 2010- 1312 dated December 14, 2010, on access to the terminal section of optical fiber networks.

Interconnection Access

Regulations governing the interconnection of each operator to the networks of the incumbent operator and of other operators are essential for opening up the market and ensuring the quality of services provided to each operator’s subscribers. Interconnection agreements are subject to private law and must be disclosed to the ARCEP if requested. The ARCEP has the power to rule on disputes between operators but its decisions may be appealed before the Paris Court of Appeal (*Cour d’Appel*).

We have interconnection agreements with local operators mainly for call termination over fixed and mobile operators. MMS tariffs are not regulated. Exchange flows amongst carriers are generally quasi-symmetrical.

Specific Regulatory Framework Applicable to the Access to New-Generation Optical Fiber Networks

The French Economy Modernization Law dated August 4, 2008, introduced several provisions aimed at setting up a regulatory framework for the roll-out of very-high-speed optical fiber networks.

The law comprises a number of measures intended to foster such roll-outs, including: (i) an obligation for private and public landlords to facilitate the installation of optical fiber networks in their buildings; (ii) rules for sharing optical fiber access in order to avoid several networks being set up within the same building (only one “building operator” may therefore set up a network in the building); (iii) a requirement for each operator offering very-high-speed access to be

able to connect to the network; and (iv) provisions stating that the access point to the shared network must be located outside the limits of a private property (unless the ARCEP approves the access point being inside a property).

In addition to the implementing decrees, the ARCEP has been given decision-making powers to set the terms and conditions relating to the application of this law.

Legal Status of the Le Cable Networks

A telecommunications network is comprised essentially of the physical infrastructure (ducts, head-ends, switches) into which the telecommunications equipment (mainly the cables) are placed. These different components can be governed by different legal statutes. Because Le Cable's physical infrastructure is not built on its own premises (but on public land and private property), Le Cable has entered into concession, easement or lease agreements with landlords. Several telecommunications operators can occupy or use the same physical infrastructure, or even the same telecommunications equipment.

One of Le Cable's cable networks (Point-à-Pitre, Guadeloupe) can be categorized as an agreement for the delegation of public services (*délégation de service public*). Under such agreement with a local authority for the delegation of public services, the infrastructure and equipment used to carry out the said public services revert back to the local authorities upon expiry or termination of the agreement (*biens de retour*). Renegotiations of these agreements were imposed by laws passed on July 9, 2004, and March 5, 2007, with a view to clarifying the legal classification of the agreements. Moreover, the law of August 4, 2008, authorized local authorities to grant equal rights of access on their network to our competitors even if the agreement with such local authorities says otherwise.

The rest of Le Cable's current cable network is governed by ad hoc legal agreements. Concerning such agreements with local authorities, Le Cable has initiated their transformation into agreements for the occupation of public domain (*conventions d'occupation du domaine public*). Occupation of public domain agreements, which are entered into with local authorities for terms ranging from 10 to 30 years, provide that, upon termination, we must, at the option of the local authority (i) return the entire network to the local authority, in some cases in return for the payment by the local authority of an amount equal to the market value of the network, in other cases free of charge, (ii) remove, either at our cost or at the cost of the local authority, the equipment installed by us on their land or premises, or (iii) transfer the network to another operator, provided it is approved by the local authority. In accordance with the law applicable to these agreements, upon expiration of long-term leases, the network reverts to the local authorities.

Fees are typically paid on an annual basis, and in principle based on the size of the network deployed on public land or premises.

Fixed Number Portability

Number portability is an obligation for all operators connecting end-subscribers. Decree 2006-82 of January 27, 2006, extended this number portability obligation to alternative landline operators. The ARCEP Decision No. 2009-0637 implementing this decree was issued on July 23, 2009, and approved by the Minister for Electronic Communications on October 22, 2009. This decision sets forth the portability obligations of operators.

An order published in the Journal official on November 1, 2013, confirmed ARCEP Decision No. 2013-0830 of June 25, 2013, specifying the new methods for allowing customers to keep fixed numbers. This decision establishes new requirements for mass-market carriers to be implemented gradually until October 1, 2015.

Directories and Provision of Subscriber Lists

All operators that connect end-subscribers are required to disclose their subscriber lists for the purpose of publishing directories and/or providing information services (as set out in more detail in ARCEP Decision No. 06-0639 of November 30, 2006).

Contribution to Universal Service Funding

Pursuant to law 2003-1365 dated December 31, 2003, the operator required to guarantee the provision of universal service is designated on the basis of calls for tender. The cost of the universal service is shared between operators pro rata to their revenues derived from telecommunications services.

Broadcasting of Audiovisual Services

The transmission and broadcast of radio and television services falls within the scope of the 2002 Telecoms Package and is consequently subject to the control of the NRAs.

As a broadcaster of radio and television services, we must declare our activities and register with the *Conseil Supérieur de l'Audiovisuel* ("CSA").

Pursuant to articles 42-1 and 42-2 of Law 86-1067 dated September 30, 1986 (as amended by Law 2004-669 dated July 9, 2004, and 2009-258 dated March 5, 2009, respectively), the sanctions available to the CSA if an operator fails to comply with the regulatory framework includes limiting the scope or reducing the term of the operator's registration, as well as suspending or even withdrawing said registration. The CSA may also impose a fine representing up to 3% of an operator's annual revenue, or 5% in the case of a repeated breach.

In our capacity as a broadcaster of audiovisual services, we are subject to the regulatory "must-carry" provisions, i.e. the obligation for a provider of services via cable, satellite or ADSL to carry certain audiovisual services on its network. The must-carry obligations are governed by Articles 34-2 and 34-4 of Law 86-1067 dated September 30, 1986 (as amended by Laws 2011-901 dated July 28, 2011, or 2009-258 dated March 5, 2009, as applicable).

Moreover, the CSA controls the content of the broadcast channels. In particular, under Article 15 of Law 86-1067 dated September 30, 1986, the CSA must enact rules to protect minors against programs considered dangerous to their physical and mental health. The CSA has put in place strict rules in this respect, including the encryption of programs and embedding of special logos on programs considered inappropriate for minors. As an operator and distributor of TV channels, we make sure that we strictly comply with these rules.

Regulation of the Content of Electronic Communications

Content of Online Services and Liabilities of Internet Market Players

The liability provisions applicable to intermediary internet service providers are set forth in Law 2004-575 dated June 21, 2004, and the CPCE and Decree 2011-219 of February 25, 2011 (as modified on March 30, 2012). They include the conditions under which providers/operators can be held civilly or criminally liable.

Copyright and the Internet

Under Law 2009 669 adopted on June 12, 2009, promoting the dissemination and protection of creative works on the internet, a specific "graduated response" system was introduced, aimed at limiting illegal downloads. The French government announced in May 2012 the setting up of an *ad hoc* commission dedicated to the reform of HADOPI. This commission issued its report on May 17, 2013, and made recommendations in the following areas: (i) public access to work and online cultural offer; (ii) remuneration of creators and financing of creation; and (iii) protection and adaptation of intellectual property rights.

The legal framework on copyright and the internet is therefore expected to be modified in the near future, as was the case pursuant to Decree 2013-596 dated July 8, 2013, mentioned above and recently by Law 1014-315 dated March 11, 2014, reinforcing means to fight against infringement. It is also anticipated that the powers of the HADOPI may be transferred to the CSA.

Processing of Personal Data and Protection of Individuals

The main applicable provisions of the revised Law 78-17 dated January 6, 1978, which is the cornerstone of the French data privacy regulations, are as follows:

- no personal data may be processed without the prior notice to and consent of the person concerned. However, a limited number of circumstances are defined in which such processing may be lawful, even without the consent of the person concerned (these exceptions do not apply to the processing of sensitive data);
- the right of data subjects to access, correct and object to the processing of their personal data must be ensured at all times;
- all processing of personal data must be notified to or duly authorized by the French data protection authority (CNIL), with the exception of very few processings;

- electronic communications providers have an obligation to report to the French authorities a breach of personal data protection which is detailed in Decree No. 2012-436 of March 30, 2012; and
- any failure to comply with the provisions of Law 78-17 is subject to administrative and/or severe criminal sanctions. The possible offenses and related penalties are set forth in Articles 226-16 to 226-24 of the French Penal Code (Code pénal). Such offenses are punishable by a fine of up to €300,000 and five years' imprisonment.

In the course of our business, we record and process personal data including statistical data, in particular data concerning the number of visits to our websites. These personal data are, however, processed pursuant to all applicable laws.

Lastly, Decree No. 2012-488 of April 13, 2012, puts additional obligations on operators to protect the safety of personal data on their networks. Operators must, *inter alia*, implement specific policies to protect the integrity of their networks.

Payment services regulations applicable to OPS

Payment services which Outremer plans to introduce through a fully-owned subsidiary, OPS, are governed in particular by Directive 2007/64/EC Articles L. 522-1 to L. 522-20 and D.522-1 to D. 522-1-2 of the French Monetary and Financial Code (the "FMFC"), as further detailed in a Decree dated October 29, 2009, setting out prudential requirements for payment institutions (the "Decree"). As a payment institution, such subsidiary is controlled by the *Autorité de Contrôle Prudentiel et de Résolution* (the "ACPR").

Prior Approval

Pursuant to the FMFC and the Decree, all payment institutions must be approved by the ACPR. When reviewing the application form, the ACPR seeks to ensure that the payment institution has adequate resources (technical, material and human) and organization to operate in compliance with the relevant regulation and examines, in particular, if the company (i) has a sound system of corporate governance, (ii) has an adequate risk-management process and internal control, (iii) has implemented one of the safeguarding methods in respect of the customers funds, holds initial capital and owns funds equal to a minimum amount determined by one of the three applicable methods, (iv) complies with security and anti-money laundering requirements. Further, it seeks to verify that the individuals declared responsible for the effective management of the payment institution possess the respectability, competence and experience, as well as the status of the shareholders who have a qualified equity holding.

Changes requiring prior approval from or notice to the ACPR

The FMFC and the Decree provide that some changes require the prior approval of the ACPR, while others only need to be notified to the ACPR. In particular and without limitation the following changes require the ACPR's prior approval: (i) change in the corporate form, (ii) change in the types of payment services provided, or (iii) change in any element which the ACPR imposed as a condition to its prior approval.

The ACPR's prior approval is also required for any direct or indirect acquisition, extension or sale of a shareholding in the payment institution by a person or group of persons (other than a person or entity within the same group) causing these persons to either (i) reach the thresholds of 10%, 20%, or 33 1/3% of the payment institution's voting rights, or (ii) acquire or give up the effective control over the payment institution's management. We have now obtained this approval from ACPR.

Rules governing the management and organization of payment institutions

The FMFC and the Decree require payment institutions to abide by a series of management and financial requirements.

Payment agents and outsourcing

When a payment institution intends to provide payment services through an agent or outsources material services, it must previously get the approval of this agent or provider from the ACPR.

Control by the ACPR

A payment institution must at all times comply with the requirements set out in the ACPR's approval and the ACPR monitors the compliance of the activities conducted by payment institutions.

The FMFC and the Decree provide that if a payment institution fails to comply with any of the requirements applicable to payment institutions, the ACPR may withdraw its approval. In such a case, the payment institution will be removed from

the list of authorized payment institutions within a maximum of 15 months from the ACPR's decision and funds received in connection with payment services must be returned to the users of the payment services or transferred to a credit or payment institution or to the Caisse des Dépôts et Consignations within this 15-month period.

The ACPR may also impose disciplinary sanctions on payment institutions, including their removal from the list of authorized payment institutions. In such a case, the institution is banned from offering payment services and, in certain circumstances, this sanction entails the dissolution of the payment institution.

Luxembourg

Legislative framework applicable to the provision of telecommunications services and networks

The Luxembourg legislature implemented parts of the Directives on the Open Network Provision with the law of March 21, 1997, on telecommunications, which initiated the liberalization of the telecommunications market. This law set a new legislative framework for the provision of telecommunications services and networks and completed the separation of regulatory functions and service provision functions with the creation of an independent regulatory authority in charge of monitoring the telecommunications sector. The abovementioned law was substantively amended by the law of May 30, 2005, on electronic communications networks and services which constitute one of the four Acts of the Telecom Reform Package.

The Telecom Reform Package is effectively composed of four Acts:

- The Act of May 30, 2005, on networks and electronic communications services repealed by the Act of February 27, 2011, on the networks and electronic communications services (the "Telecom Act");
- The Act of May 30, 2005, on the organization of the management of radio frequency spectrum last amended by the Act of February 27, 2011 (the "Spectrum Act");
- The Act of May 30, 2005, on the organization of the Luxembourg Institute of Regulation amended on several occasions and;
- The Act of May 30, 2005, on the specific provisions regarding the protection of individuals as to the processing of personal data in the electronic communications sector (the "Personal Data in Electronic Communication Act").

Legal regime

Electronic communications services and network

Under article 2(27) of the Telecom Act, "electronic communications service" means a service normally provided for remuneration which consists wholly or mainly in the conveyance of signals on electronic communications networks, including telecommunications services and transmission services in networks used for broadcasting, but exclude services providing, or exercising, editorial control over, content transmitted using electronic communications networks and services. It does not include information society services which do not consist wholly or mainly in the conveyance of signals on electronic communications networks.

Under article 2(24) of the Telecom Act, "electronic communications network" means transmission systems and, where applicable, switching or routing equipment and other resources which permit the conveyance of signals by wire, by radio, by optical or by other electromagnetic means, including satellite networks, fixed (circuit and packet switched, including internet) and mobile terrestrial networks, electricity cable systems, to the extent that they are used for the purpose of transmitting signals, networks used for radio and television broadcasting, and cable television networks, irrespective of the type of information conveyed.

Under Luxembourg regulation, operators are free to provide electronic communications networks and services. Indeed, under article 7 of the law of February 27, 2011, the 2011 E-Law, the provision of electronic communications services and networks can be freely exercised. Any undertaking, however, wishing to engage in such activities must first notify the Luxembourg Regulatory Institute ("LRI") which regulates electronic communications networks and services.

The undertaking must initiate the notification procedure at least 20 days before commencing. The LRI provides a standard notification form to the undertakings. Upon receipt of the notification, the LRI issues within one week, at the request of the concerned undertaking, a standardized certificate, proving that the entity has duly filed a notification.

In principle, the LRI regulates upstream by preventing any hindrance to competition in regulated sectors and freedom of economic activity while the Luxembourg Competition Council regulates downstream by sanctioning such anti-competitive hindrances.

The LRI is also entrusted with the collection of notifications sent by undertakings planning to provide electronic communications networks and services (“notified undertakings”) and maintains a registry of notified undertakings.

The LRI also has the possibility to impose sanctions on notified undertakings not complying with the related regulations, specifications made in their implementation, and the regulatory measures of the LRI.

The maximum fine that the LRI may impose on notified undertakings is of €1 million. The LRI may also impose a daily fine (penalty) of an amount between €200 and €2,000, fixed according to the economic capacity of the undertaking and the nature of the infringement. Such a fine may be doubled for a second offense.

The LRI may also take complementary or alternative disciplinary sanctions (e.g. warnings, prohibitions on carrying out certain operations, or temporary suspension of one or more managers or directors of an undertaking).

The LRI is entitled to suspend, temporarily or definitely, without giving rise to any right to compensation, the services provided by a notified undertaking after having notified such undertaking of its infringement of the law.

Content regulation and protection

Pursuant to the Personal Data in Electronic Communication Act, operators of electronic communication services and networks are compelled to ensure the confidentiality of communication exchanged by way of electronic communication means.

The general rule is that other than the user, no person is allowed to listen, intercept or store communications and data related to the traffic and location without the agreement of the user.

This prohibition does not apply to communication related to emergency calls, commercial transactions to the extent that they constitute proof of the transactions, authorities investigating and acting in relation to a *flagrante delicto* or within the scope of criminal offenses in order to ensure national and public security and cookies. In relation to data resulting from commercial transactions and cookies, the user or parties to the transaction must be informed that their data may be processed, the conditions (in particular the duration) and aim of the storage, and the possibility of the user opposing such data processing.

Radio Spectrum

The use of radio spectrum is regulated by the Spectrum Act and the Grand Ducal decree of April 7, 2011, on the administrative taxes applicable to telecommunications.

The frequencies are granted by the minister responsible for communications, in accordance with the national plan of allocation and assignment of frequencies. This plan allocates specific frequencies by type of use. The aim is to ensure the quality of the service and to avoid interferences. The Minister might consider technological neutrality where all the parameters ensuring service quality for shared channels are known.

Frequencies can be granted upon request or under certain circumstances (e.g. if several candidates request the exclusive use of the same frequency) through an open tendering allowing for the selection of the candidates on one of the following criteria: best offer, competition, or comparison.

The use of spectrum cannot be made license exempt. Nevertheless, spectrum can be made exempt from individual licensing. In this case, general conditions applicable to a certain type of application are pre-defined and, as far as these conditions are met, no individual license is required.

The Grand Ducal decree of April 7, 2011, on the administrative taxes applicable to telecommunications set out the fees and levies that have to be paid. For some applications, the fees have been defined in the license itself. Generally, the fees are linked to the used amount of the spectrum.

Since the implementation of the law of February 27, 2011, allocating licenses are no longer personal. On that account it is currently possible to sell, transfer or sublease allocated spectrum, thus enhancing the flexibility of spectrum use.

Audio visual Media

Overview

The media sector is mainly governed by the Act of July 27, 1991, on electronic media as amended by the Act of December 17, 2010, and the law of April 8, 2011, (the “Electronic Media Act”) and the law of April 11, 2010, on freedom of expression in electronic media amending the law of June 8, 2004 (as amended), on the freedom of expression in the media sector. A certain number of Grand ducal decrees also regulate the media sector.

In addition, two Acts governs the audiovisual production:

- the Act of December 21, 1998, establishing a temporary special tax regime for audiovisual investment certificates; and
- the Act of March 16, 1999, creating a national support fund for audiovisual production.

The media law creates several governmental commissions, the first of which is the Media and Communications Services which assists the Minister in the determination and the execution of the Luxembourg media policy. Its main responsibilities are to:

- promote the development of the programs viewable by the Luxembourg population;
- promote, in concert with other commissions and committees, Luxembourg as a European center for audio visual and communication activities;
- assist government representatives responsible for the supervision of the beneficiaries of licenses or authorization; and
- ensure communication with international organizations responsible for the supervision of the audio visual sector and ensure representative function within certain European committees.

In addition, there is also the Independent Radio broadcasting Commission which has three main functions:

- implementing provisions relating to authorizations of low powers transmitters;
- advising the government in authorization matters; and
- arbitration of specific potential disputes.

Finally, the National Programming Council is an independent body advising the government on matters of surveillance of certain specific television and radio programs and proposes a balanced content for socio-cultural radio programs.

A new bill of law presented on October 10, 2012, modifying the law of July 27, 1991, on electronic media aims at centralizing the competence of the three existing commissions into one single authority, “the Luxembourg Independent Audi-visual Authority”, which will gain disciplinary powers and adopt the status of a public institution.

Legal regime

The Media law has been recently amended in order to adapt itself to the newest sorts of audio visual and radio media. More importance is attributed to content regulation. Rules are set related to enhance the protection for children and non-discriminatory content and the form and the content of commercials advertising are more regulated.

Licenses for distribution of audi-visual media

Pursuant to article 2 of the Electronic Media Act, any program which is transmitted to the public through a Luxembourg broadcasting frequency is considered a television or radio program. Pursuant to article 3 of the Electronic Media Act, no one can transmit a radio or television program without having obtained prior permission or a license granted by the Prime Minister assisting by the Services of Media and Telecommunications.

Thus, a company willing to develop an audiovisual media service (either a television or an on-demand audiovisual media service) would be required to notify to the Ministry of Economies of its intention to provide such a service either because it is considered as a Luxembourg provider or under some circumstances as a foreign media service provider by the

amended Electronic Media Act which provides the applicable criteria in this respect. In that case, the company shall notify the Ministry of Economies at least 20 days prior to launching the service.

License for a Luxembourg satellite program

Applications for the granting of licenses are required to be sent by email to the Prime Minister and the Department of Media and Communication. Information about the applicant and the relevant program must be attached to the application.

The Department of Media and Communication conducts an initial review. If it is deemed complete, the license application is forwarded to the Independent Commission on broadcasting for advice. The final decision is taken by the government on the advice of the Prime Minister, and the license is granted by the Prime Minister on behalf of the government.

License for Luxembourg cable program (TV and Radio)

The same process as license for a Luxembourg satellite program is required to be conducted for a license for a Luxembourg cable program.

Permission for sound radio program

The allocation of frequency is subject to the condition that a terrestrial frequency is available in Luxembourg. In this case, terrestrial frequencies are granted following a public call nomination. The Independent Commission on broadcasting is the body that grants the permission for programs to low power transmitters and make the call for nomination for these frequencies.

Internet infrastructure

Overview

Internet access services as well as services provided through internet are regulated by the Telecom Act of May 30, 2005, which has been amended by the Act of February 27, 2011.

Internet services providers are subject to telecommunications regulation depending on the type of services that is considered (i.e. access services would be regulated by electronic communications laws whereas content would depend on a different set of legislation).

Further, cyber security is one of the priorities of the Luxembourg government. Individuals and companies are encouraged to take appropriate measures to defend themselves against cyber attacks. Similarly, the government has created “CASES Luxembourg” which is a project accessible by all internet users, the purpose of which is to make the public aware of a potential cyber attack inherent to internet use and advises on how to identify them.

In July 2011, the government created two new structures: the Luxembourgish Cybersecurity Board whose mission is to work on a strategic plan against attacks via the internet, and the governmental Computer Emergency Response Team which is responsible if an incident of cyber crime ever occurs in the public information systems.

To date there is no legal obligation for operators or internet service providers to assist content owners whose rights may be infringed. However, to be exempt of liability in such a case, internet services providers shall act promptly to remove or disable access to content upon knowledge of facts or circumstances that such content is obviously illegal.

To date, there are no restrictions blocking on service providers by operators. From a legislative point of view, Luxembourg is one of the countries which defended net neutrality in the framework adoption of the telecom package.

Legal regime

Pursuant to article 5 of the Telecom Act, the operation of electronic communication services or networks, notably internet services and IP- services, is subject to a notification to the Luxembourg Institute of Regulation (*Institut Luxembourgeois de Régulation*) (the “ILR”).

Concerning internet service providers, the law on electronic commerce as amended of August 14, 2000, provides the obligation for hosting and caching providers to stop the activity or information from the moment that it has an actual

knowledge that the activity or information is illegal or from the moment that the facts and circumstances show apparently that the activity or information is unlawful.

Others

The laws listed below may be also applicable to the telecommunication, media and internet sector:

- the law of April 18, 2001, on copyrights as amended;
- the law of August 2 2002, as amended (for the last time by a law of July 28, 2011) regarding the protection of individuals as to the processing of personal data;
- the law of May 15, 2006, related to trademarks;
- the law of August 11, 1982, on privacy;
- the Consumer code introduced by the law of April 8, 2011.

General laws are applicable for all aspects not specifically regulated by laws or regulations, in particular the provisions of the Luxembourg Criminal Code (e.g. in relation to pornography, discrimination, racism, violence theft and privacy).

In addition, a large number of Grand Ducal regulations and other regulations (particularly from ILR) have been adopted in relation to the implementation of various laws.

Portugal

Liberalization of the Portuguese telecommunications market

The first Portuguese telecommunications regulatory framework was enacted in 1989 under Law 88/89 of September 11, 1989, to regulate the opening of the telecommunications network to private enterprises. This initial regulatory package divided the industry into two main areas: (i) a state owned and monopolistic basic telecommunications network and services, which meant the fixed national telephony services and some associated facilities, run by the publicly owned companies that in 1995 merged to form the PT Group; and (ii) the so-called complementary services which assembled a large group of mainly private operators ranging from mobile wireless operators (using GSM), paging, trunking, VSAT and data transmission (using mainly Frame Relay and X25 protocols).

Following the 1996 revision of the European Unions' ONP Directives (e.g. Directives ⁹⁶/₂/EC, ⁹⁶/₁₉/EC and ⁹⁷/₁₃/EC), in August 1997 the Portuguese Government decided to revise the whole regulatory structure and submitted to Parliament a new Telecommunications Bill aimed at establishing "the general bases that regulate the establishment, management and exploitation of telecommunications networks and the provision of telecommunications services" later enacted as Law 91/97 of August 28, 1997 (the "1997 Telecommunications Law"). The adoption of a "full liberalization" principle accelerated the progressive opening of the Portuguese telecommunications market to new entrants, and was completed on January 1, 2000, with the end of the Portugal Telecom's legal monopoly over fixed-telephony services.

Legal framework

Following the major review of existing EU telecommunications law that resulted in the adoption of a new regulatory framework for electronic communications in 2002, known as the "Review 99" Directives, the Portuguese Parliament enacted Law 5/2004 of February 10, 2004 (the "2004 Communications Law"). The new legislation transposed the EU Review 99 package Directives and regulations to national law and revoked all previous regulations containing provisions related to general market framework, licensing, interconnection and all telecommunications networks and service provision, with the exception of radio communications, telecommunications infrastructure and supply of electronic equipment.

In 2011, Law 51/2011 of September 13, 2011, amended the 2004 Communications Law, transposing other EU Directives to national law. Although some provisions of the 2004 Communications Law already dealt with data privacy issues, the Data Protection Directive (Directive 2002/58/EC) was transposed by Law 41/2004 of August 18, 2004.

Regulatory Institutions

- *European Commission.* The Directorate General for Competition of the European Commission (the "EC"), is responsible for considering potential claims that our business activities or Portuguese government regulations are

inconsistent with the key provisions of the Treaty on the Functioning of the European Union (“TFEU”) relating to competition in the EU. Among other things, the TFEU prohibits (i) agreements or coordinated action between competitors that may affect trade between EU member states and have as their objective or effect the prevention, restriction or distortion of competition within the EU, and (ii) any abuse of a market-dominant position within the EU that may affect trade between EU member states. The Directorate General for Competition enforces these rules in cooperation with national competition authorities. In addition, national courts have jurisdiction over violations of EU competition law. The Directorate General for Communications Networks, Content & Technology (DG Connect) of the EC is responsible for, among others, coordinating the regulatory framework for competition and growth over the entire range of issues in the telecommunications field: economic analysis, impact assessment, policy development and regulatory compliance.

- *ANACOM.* The *Autoridade Nacional das Comunicações* (the “ANACOM”) is the Portuguese telecommunications regulator. It advises the Portuguese government on telecommunications policy and legislation and monitors compliance with concessions, licenses and permits granted to telecommunications networks and services providers in Portugal. The Portuguese government has substantially increased the autonomy of ANACOM and has allowed it to become a more effective and independent regulatory body. ANACOM acts on complaints against us by our competitors, our customers and other interested parties. It can impose fines on us if we do not meet our obligations under the law or its determinations. ANACOM’s decisions are subject to judicial review. The statutes of ANACOM were approved by Decree Law 309/2001 of December 7, 2001. Pursuant to Law 67/2013 of August 28, 2013, which establishes a general framework for regulatory authorities, ANACOM is expected to undergo statutory changes in the near future.
- *Portuguese Competition Authority.* Our activities are also overseen by the Portuguese Competition Authority (*Autoridade da Concorrência*), which is responsible for the enforcement of competition law in Portugal. It is also responsible for considering complaints relating to our business practices or other business arrangements. Under Portuguese law, we are permitted to appeal any adverse decision of the Portuguese Competition Authority to the courts. The Portuguese Competition Authority’s decisions are subject to judicial review.
- *ERC.* The *Entidade Reguladora para a Comunicação Social* (the “ERC”), is the independent regulatory authority for the Portuguese media. ERC’s primary responsibilities are the regulation and supervision of all entities that undertake media activities in Portugal. The ERC is a legal entity endowed with administrative and financial autonomy. The ERC oversees compliance with respect to fundamental rights such as freedom of the press, right to information, independence from political and economic power and freedom of speech. It is also responsible for monitoring compliance by all companies operating in the media sector, with standards for media and broadcast content, as well as for promoting the proper and effective functioning of the market where such companies operate. The ERC’s decisions may affect, among others, news agencies, periodicals, radio or television operators, and radio and television distribution operators.

Key legislation

The key statutes and regulations setting the current telecommunications legal framework in Portugal are:

- The 2004 Communications Law, as amended;
- Law 67/2013 of August 28, 2013, which establishes a general framework for regulatory authorities;
- Law 42/2013 of July 3, 2013, which sets out rules on selective communication barring, namely regarding value-added services;
- Law 10/2013 of January 28, 2013, on the strengthening of electronic communications services consumer protection;
- Law 55/2012 of September 6, 2012, on the financing of audio-visual and independent cinema works (the “Cinema Law”);
- Decree Law 56/2010 of June 1, 2010, on the unlocking of terminal equipment to allow access to electronic communication services;
- Decree Law 123/2009 of May 21, 2009, as last amended by Law 47/2013, of July 10, 2013, setting up rules on the access to infrastructure suitable for usage by telecom services (ITUR and ITED regulations);
- Law 99/2009 of September 4, 2009, approving the legal framework of administrative offences within the communications sector;

- Administrative Rule 1473-B/2008 of December 17, 2008, as amended, on regulatory fees;
- ANACOM Regulation 58/2005 of August 18, 2005, as amended by Regulation 114/2012, of March 13, 2012, on number portability;
- Law 41/2004 of August 18, 2004, regulating the processing of personal data and the protection of privacy in the electronic communications sector, as amended;
- ANACOM Regulation 38/2004 of September 29, 2004, on the procedures for the collection and delivery of the MFRW to municipalities;
- Decree Law 7/2004 of January 7, 2004, on information society services and electronic commerce;
- Decree Law 309/2001 of December 7, 2001, which approved the statutes of ANACOM;
- The 2001 Radio Communications Law;
- Decree Law 151-A/2000 of 28 of September, 2000, as last amended by the Decree Law 264/2009 of 28 of September, 2009, regarding the licensing of the radiocommunications networks (article 19 amended by Law 20/2012 of May 14, 2012); and
- Decree Law 192/2000 of 18 of August, 2000, which approves the free movement of radio equipment and telecommunication terminals.

EU Regulatory Framework and Relevant Markets

The EU regulatory framework for electronic communications networks and services consists of five directives governing procedures, authorizations, access, universal service and data protection; a recommendation on relevant product and service markets within the electronic communications sector subject to “*ex ante*” regulation under a common regulatory framework for electronic communications networks and services; and two regulation, one concerning the Body of European Regulators for Electronic Communications (BEREC), the other concerning roaming on public mobile communications networks. EU directives, regulations and recommendations, which adopt competition law principles such as market dominance for the designation of significant market power and the definitions of relevant product and geographic markets, which may be subject to “*ex ante*” regulation, have involved constant changes and refinements to this framework. The framework focuses on issues such as reinforcing consumer rights, encouraging competitive conditions among operators to increase consumer choice, promoting investment in new communications infrastructure (such as by freeing spectrum for the provision of broadband services) and ensuring network security and integrity. Under the current regulatory framework, obligations can be imposed on operators having significant market power in any of the one retail and six wholesale markets identified by the EC. Because we are active in all of these markets, these regulatory measures have affected, and will affect, our businesses and operations.

Within the EU framework, ANACOM has identified, in the first round of analysis initiated in 2004, 19 retail and wholesale markets in Portugal. In a process it is required to undergo periodically, ANACOM has found Portugal Telecom to have significant market power in all but one of the analyzed markets, where ANACOM determined that no operator had significant market power (wholesale transit services). These markets included: (i) retail markets—access to the public telephone network at a fixed location (residential and business), publicly available local and/or national telephone services provided at a fixed location (residential and business), publicly available international telephone services provided at a fixed location (residential and business), telephone services at a fixed location using non-geographic numbers, such as toll-free numbers and leased lines; and (ii) wholesale markets—call origination on the fixed telephone network provided at a fixed location, call termination on individual public telephone networks provided at a fixed location and wholesale unbundled access to local metallic loops, wholesale leased lines (trunk segments and terminating segments) and wholesale broadband access.

In its second round of analysis, ANACOM conducted a market analysis to determine the regulatory obligations that should be imposed on operators with significant market power in the provision of wholesale (physical) network infrastructure access and wholesale broadband access. With respect to Wholesale Markets 4 and 5 (for the provision of wholesale (physical) network infrastructure access and wholesale broadband access), ANACOM has segmented the broadband market geographically between “C” (competitive) areas and “NC” (non-competitive) areas. In the “NC” areas we are obligated to provide a wholesale local loop unbundling reference offer (in relation to Market 4) and to provide a wholesale broadband (bitstream) reference offer (in relation to Market 5). Market 5 was deregulated in “C” areas, and hence all obligations in this market, including the wholesale bitstream reference offer, no longer apply. Nevertheless, while our obligation to provide a bitstream reference offer (Rede ADSL PT) in “C” areas expired after a transitional

period, we have decided to maintain the bitstream reference offer. See “*Areas of Recent Regulation and Updates—Next Generation Access Networks*”.

In addition to Portugal Telecom, all other fixed-line operators in Portugal were determined to have significant market power in the call termination on individual public telephone networks provided at a fixed-location wholesale market. Likewise, all mobile network operators were found to have significant market power in the call termination on individual mobile networks. ANACOM has found Portugal Telecom to have significant market power in the wholesale leased lines terminal market and segmented the transit segments between “C” and “NC” routes. In these wholesale markets, ANACOM included Ethernet connections and imposed the retail-minus rule over Ethernet solutions. In the “C” routes, Portugal Telecom has no significant market power. We expect that ANACOM will provide further analysis of the other relevant markets in the near future.

In December 2013, ANACOM launched a public consultation on a draft decision regarding the re-analysis of the retail markets for fixed-access and telephony services and of the wholesale market for call origination at a fixed location. ANACOM is proposing to withdraw the existing retail regulation in those markets while continuing to fully regulate the wholesale call origination market.

Our Concessions and Existing Licenses and Authorizations

General

The EU prohibits any limitation on the number of new entrants in telecommunications markets, except as required to ensure efficient use of radio frequencies. Pursuant to this directive, which is part of the EU electronic communications framework, an operator must have a general authorization for the provision of electronic communications networks or services. A license for individual rights of use can be required for the use of radio frequencies or numbering resources. The objective of this authorization regime is to introduce more flexibility into the licensing framework.

Currently, we hold two concessions, one regarding the provision of public payphone services, and another regarding the provision of directory services, which permit us to provide fixed-line publicly-available payphones and directory and directory inquiry services in Portugal. Until June 1, 2014, we were also the holders of the universal service public switched fixed-line concession, as described under “—*The Fixed-line Concession*” below.

We also operate a DTT platform and provide mobile telephone services, data communications services and television distribution services under the licenses granted and authorizations issued to our subsidiaries by the relevant authorities (the Portuguese government and ANACOM). The subsidiaries holding the licenses and authorizations are subject to separate financial reporting and other requirements.

The Ministry of Finance is responsible for monitoring financial issues with respect to our concessions. The Ministry of Economy is responsible for all other issues under our concessions. Disputes concerning the application and interpretation of our concessions are resolved through arbitration. ANACOM is responsible for issuing regulations and is authorized to monitor and apply administrative penalties up to a maximum of €5 million if we fail to fulfil our obligations under our concessions or other obligations imposed by law.

The Fixed-Line Concession

The Portuguese government granted us a concession, held by PTC, with an initial term expiring in 2025, which was terminated early after PTC and the Portuguese government reached an agreement in November 2013 on its revocation, following the designation of ZON and Optimus as the universal service provider of access to a publicly available electronic communications network and telephone services at a fixed location. On March 7, 2014, Decree Law 35/2014 was published in the Portuguese official gazette, formally revoking our concession agreement pursuant to the November 2013 revocation agreement signed by us and the Portuguese government and also pursuant to Resolution of the Council of Ministers n. 66-A/2013, of October 18, 2013, that authorized that revocation agreement. The revocation became effective on June 1, 2014. As of that date, the fixed-line universal services are being provided by ZON and Optimus. The revocation was due to, amongst other factors, a decision from the European Union Court of Justice, of October 7, 2010, on the grounds that Law 5/2004, of February 10, 2004, whilst keeping in force PTC’s universal services concession until 2025, did not comply with Directive 2002/22/CE, of the European Parliament and the Council, of March 7, 2002, as amended by Directive 2009/36/CE, of the European Parliament and the Council, of November 25, 2009.

The fixed-line concession granted us the right to install, manage and operate the infrastructure that forms part of the basic telecommunications network. It also stipulated the provision of maritime mobile service, fixed telex service, fixed switched data transmission service and telegraph service, as services of public interest. Under the Electronic Communication Law of 2004, as the Universal Service Provider, PTC was also obligated to provide a comprehensive directory and directory inquiry services. However, other than our ceasing to be the Universal Service Provider (except

with respect to public payphones and directory services, which we have been awarded under new concession contracts), as described in “—*Areas of Recent Regulation and Updates—Universal Service Obligations*” below, the revocation of the fixed-line concession will not cause any material change in the telecommunications services we are able to provide.

Prior to the revocation of the fixed-line concession, the Portuguese government, by resolution of the Council of Ministers of January 10, 2013, determined that the maritime mobile service should cease to be provided as a service of public interest from April 30, 2013. After informing the subscribers of this service of the termination in advance, PT Comunicações proceeded to terminate it. In addition, pursuant to the Resolution of the Council of Ministers published on October 18, 2013, fixed telex service, fixed switched data transmission service and telegraph service (telegrams) no longer had the nature of public services as of January 31, 2014, thus terminating PT Comunicações’ legal obligation to assure their provision. The clients of the first two services were informed of such discontinuation in advance. PTC opted to commercially continue the provision of fixed telegraph service as of February 1, 2014.

Our Public Payphones and Directory Services Concessions

On October 12, 2012, in anticipation of the renegotiation of the fixed- line concession and following ANACOM’s decision on the designation of a universal service provider under a competitive process, PTC submitted the lowest bid in the public tender for the provision of the publicly available telephones service and was awarded with the concession contract. The concession contract was entered into on February 20, 2014, for a period of five years. PTC and ANACOM have recently been exchanging letters concerning the evolution of PTC’s fulfilment of its obligation to install the agreed quantity of public payphones in the areas covered by the Universal Service Contract.

On July 29, 2013, the Portuguese government decided to initiate a direct award procedure in respect of the provision of comprehensive directory and directory inquiry services for a period of 12 months, with the possibility of such period being extended for an additional six months. As the only company that presented a proposal, on November 7, 2013, the Portuguese government awarded PTC with the comprehensive directory and directory inquiry services concession. The concession contract was entered into on February 20, 2014.

DTT Services

For a summary of our usage rights for DTT, see “*Areas of Recent Regulation and Updates—DTT Services*” below.

Our Fixed-line, Data and Frequency use Licenses

We also hold the following licenses: (i) a non-exclusive license to provide fixed-line telephone services; (ii) a non-exclusive license to be a “Public Telecommunications Networks” operator; (iii) all the licenses formerly held by Telepac and other subsidiaries, including a data communications license, and (iv) frequency use licenses. Our current data communications license authorizes us to provide X.25/X.32 synchronous services and X.28 asynchronous services and other switched and non-switched data communications services, including frame relay and virtual private networks for data communications. The license also authorizes us to provide value-added services such as electronic data interchange and videotext services. In addition, the license authorizes us to construct certain network infrastructure in connection with licensed services. Licenses have also been granted to other providers of data communications and internet access services, including companies associated with major international telecommunications providers. However, companies are not required to have a license to provide data communications services and internet access. Instead, it is sufficient to register their intended services with ANACOM under its service registration scheme. Since 1997, we have also held a license to provide data communications services using satellite infrastructure and a license to offer voice services to corporate networks and other closed groups of users.

Meo Mobile Service License

Portuguese mobile telephone service licenses are valid for 15 years and are issued by ANACOM. These licenses authorize the use of radio spectrum and the installation of base stations, base station controllers and control switching centers and require the licensee to construct networks capable of reaching at least 75% of Portugal’s population within a specified period. Charges for the provision of mobile telephone services are not subject to regulation.

Through *Meo*, we hold a renewable license to provide traditional and GSM digital mobile telephone services throughout Portugal. The authorization for the use of GSM radio spectrum is valid until March 16, 2022. We are required to comply with a number of mobile telephone service criteria, including satisfying minimum quality standards regarding blocked call rates, network effectiveness and servicing time, and providing certain services. We are also required to provide ANACOM with information about our mobile telephone operations, including the number of customers, number and average duration of calls on a quarterly basis, and annual information about the development of infrastructure.

ANACOM also issues UMTS licenses, which are the European version of the globally accepted technical standards for 3G mobile communications. The broadband capacity of the frequency spectrum allocated under the UMTS licenses enables operators to supply video and internet content to mobile telephones at higher transmission speeds. On January 5, 2012, ANACOM issued a final report on an auction for the allocation of rights of use of frequencies in the 450, 800, 900, 1800 MHz and 2.1 and 2.6 GHz bands. Following that auction, on March 9, 2012, ANACOM issued the final renewable license to *Meo*, allowing the provision of electronic communications services based, among others, on LTE technology. This license is valid until March 2027, and it also unifies the previous GSM and UMTS licenses issued by ANACOM.

Areas of Recent Regulation and Updates

Number Portability and Carrier Selection

Number portability allows a subscriber at a specific location to change service providers without having to change telephone numbers. Under ANACOM regulations, we are required to allow number portability for both fixed-line and mobile services within one working day, save for in exceptional circumstances duly identified. ANACOM requires call-by-call carrier selection to be offered by us for long distance and international calls. Call-by-call carrier selection enables customers to select the carrier of their calls by dialing a code connecting them to the selected carrier. All fixed-line network operators with significant market power must offer carrier pre-selection. Carrier pre-selection allows customers to select the carrier that will be their default carrier. This removes the need for customers to dial any code to connect to their selected carrier when making calls.

DTT Services

PTC holds frequency usage rights for DTT associated with the transport of the signal of free-to-air television channels (the RTP, SIC and TVI broadcast channels), the so-called “Multiplex A” or “Mux A”. PT Comunicações is entitled to receive compensation or reimbursement, to be provided pursuant to a governmental ordinance, for the costs related to the channel update process. The switch-off of the analog television network in Portugal occurred on April 26, 2012. Designed to ensure equal access to DTT, the DTT usage rights require PTC to subsidize the installation and purchase of DTT-related equipment for individuals with special needs (e.g. the elderly, low income groups, etc.).

In July 2014, ANACOM published a draft decision relating to DTT coverage in which it defined coverage obligations by municipality depending on population as well as what constituted a period of unavailability. PTC replied to this consultation expressing its disagreement on certain matters, such as the definition of coverage obligations noted above, that, if implemented, may have a material impact on the fulfilment of its service obligations under its DTT license.

In September 2014, ANACOM issued a decision authorizing PTC to implement four additional MFN channels to function alongside its SFN network. In the decision ANACOM also expressed the view that in certain municipalities PTC’s network does not comply with its license and therefore PTC must implement an additional five MFN channels to function alongside its SFN network. PTC considers itself to have fulfilled its obligations with respect to the usage grant and to have successfully concluded the channel update process and therefore has expressed its disagreement to ANACOM over the alleged breach of its obligations under its DTT license and is awaiting a final decision by ANACOM on that matter and whether implementation of an additional five MFN channels is necessary.

Wholesale Reference Offers (Unbundling the Local Loop)

The EC requires fixed-line network operators found to have significant market power in the relevant wholesale market for physical network infrastructure access at a fixed location to make the local loops between their customers and the local switches on their networks available to competitors. This allows such competitors to connect their networks to the copper local loop and use it to provide their services directly to those customers without having to invest in the local loop or to rely upon the network operator’s relationship with the customers. Under this regulation, we are required to maintain a reference offer for unbundled access to our local loops and related facilities and to meet reasonable requests for unbundled access to our local loops and related facilities under transparent, fair and non-discriminatory conditions. Prices charged must be cost-oriented. The conditions under which the local loop unbundling services are provided are set forth in a published reference offer for unbundled access to our local loops in accordance with terms established by ANACOM. This reference offer covers all of our main distribution framework buildings where technical and space conditions allow co-location. Co-location means providing space and technical facilities to competitors to the extent necessary to reasonably accommodate and connect the relevant equipment of the competitor.

Leased Lines Reference Offers and Ethernet Access Reference Offers

Our Leased Lines Reference Offer (*oferta de referência de circuitos alugados*), or “ORCA”, sets forth the characteristics and the technical and commercial conditions associated with the provision of leased circuits by PTC in the wholesale markets. Our Ethernet Accesses Reference Offer (*oferta de referência de circuitos Ethernet*), or “ORCE”, sets forth the

characteristics and the technical and commercial conditions associated with the provision of ethernet circuits by PTC in the wholesale markets.

Following a decision by ANACOM on leased line markets, the retail leased- line market was deregulated meaning that our prices in this market ceased to be subject to a 26% retail-minus rule. However, for the wholesale leased-line markets, in which we were declared an operator with significant market power, ANACOM decided to make Ethernet circuits subject to a retail-minus rule (which remains undefined by ANACOM). On July 14, 2012, ANACOM approved a final decision amending our ORCA and ORCE, the draft decision of which has been provided to the EC (which has subsequently stated it had no comment to the action), BEREC and national regulatory authorities of other Member States of the European Union. We have challenged this decision before the courts, arguing that the decision was illegal in certain respects. The court procedure is on- going.

On December 19, 2014, ANACOM issued a project decision regarding wholesale leased lines. Among other measures, ANACOM has determined a 50% reduction on the wholesale leased lines prices being charged by PTC for the Azores and Madeira traditional circuits (submarine cables) with a 25% price reduction to become effective within 30 days as from the final decision by ANACOM, and an additional 25% to become effective one year after the enforcement of the first 25% reduction. The project decision in question also aims to establish a fixed price for the lease by PTC of ethernet underwater circuits connecting the mainland to the Azores and Madeira, which is to be settled at €90,000 per year per Gbps within 30 days of the final ruling and at €56,000 per year per Gbps to become effective one year after the enactment of the first price reduction. PTC is entitled to issue its opinion on the project decision within 30 days as from December 19, 2014. ANACOM shall issue its final decision once the 30 days hearing right period has passed and taking into account the opinions conveyed by the market operators.

Co-installation Obligations

At the same time as the July 14, 2012, decision regarding PTC's ORCA and ORCE, ANACOM extended PTC's co-installation obligations under its regulated reference offers to its submarine cable landing stations. ANACOM has since requested information from PTC on the fulfilment of its obligation to provide access to its submarine cable landing stations to other operators for the purposes of co-location. PTC considers that it has fulfilled its obligation in this respect by allowing co-location in the local area exchanges closest to the submarine landing stations. To date, no formal proceedings on this issue have been initiated by ANACOM.

Wholesale Market for Voice Call Termination on Individual Mobile Networks

The regulation of the market for wholesale voice call termination establishes a price control obligation on wholesale voice call termination services. Following EC recommendations on the regulatory treatment of fixed and mobile termination rates in the EU, this price control results in a cost-oriented price cap determined by a pure Long-Range Average Incremental Cost, or "LRIC", bottom-up cost model.

On April 30, 2012, ANACOM set the termination rates to be applied in the wholesale market for voice call termination on individual mobile networks. In accordance with ANACOM's decision, the cost model for mobile termination set the maximum prices to be applied by the three mobile operators considered to have significant market power at €1.27 per minute, to be billed per second from the first second and independent of the origin of the call.

Next Generation Access Networks

ANACOM provides a segmented approach on the regulation of Next Generation Access Networks ("NGAs"), which addresses several issues, including market and technological issues, the impact of NGAs on existing networks, applicable development models, public policy considerations and regulatory models. In areas designated "C" (competitive) areas, the main obligation is access to ducts, and in areas designated "NC" (non-competitive) areas, the obligations are access to ducts, access to fiber and advanced bitstream, subject to conditions. On February 6, 2012, ANACOM approved a draft decision related to the definition of the markets of wholesale (physical) network infrastructure access ("Market 4") and wholesale broadband access ("Market 5"), evaluation of significant market power and the imposition, maintenance, modification or suppression of regulatory obligations. ANACOM proposes to maintain the national scope of Market 4 and the geographic segmentation in Market 5, which is divided into "NC" Areas and "C" Areas (the latter unregulated). According to this draft decision, we will continue to be considered to have significant market power in Markets 4 and 5.

According to the draft decision concerning access obligations in the market of wholesale (physical) network infrastructure access, in addition to the obligation of granting unbundled access to copper loops and subloops and to ducts and poles at the national level, ANACOM intends to impose a geographically differentiated obligation to grant virtual access to optical fiber (advanced bitstream). This obligation would not be imposed in 17 municipalities that are considered to have conditions for other operators to invest in fiber. In addition, we would also be required to demonstrate to ANACOM that the difference between our retail prices and the prices of the wholesale offers made available to other

operators does not result in a margin squeeze. The review was not concluded, due to the changes that took place in the domestic market during 2013 (merger between Zon and Optimus and investments initiated by Vodafone and Altice for expansion of their fiber networks) and the publication, in September 2013, of the EC's recommendation on NGA non-discrimination and costing methodologies. In light of these developments, a new ANACOM consultation on Markets 4 and 5 is expected in the near future.

With respect to the roll-out of optic fiber networks, current Portuguese law establishes a legal framework for the construction of and access to infrastructure suitable for the accommodation of electronic communications networks and the construction of infrastructure for telecommunications in housing developments, urban settlements and concentrations of buildings. The law addresses access to the public domain, expropriation and the constitution of public easements, and amendments to existing law in 2009 introduced a new level of harmonization and transparency in procedures. In particular, the 2009 changes set forth several obligations in order to allow electronic communications operators to enjoy better conditions necessary for the installation and development of electronic communications networks.

The current legal framework also foresees the implementation of a Centralized Information System ("SIC"), to be managed and operated by ANACOM and whose main objective is to make available information on infrastructure appropriate for the installation of electronic communications networks based on information provided by the Portuguese government, autonomous regions, municipalities, publicly held companies or concessionaires, other entities owning or using infrastructure in the public domain, autonomous regions or municipalities and electronic communications undertakings. Other elements, such as the terms upon which objects will be geographically defined through the combination of their administrative location and georeferencing, are also set forth.

Since PT Comunicações already has reference offers under which it is required to provide a substantial amount of information to operators that wish to use its ducts, poles and associated infrastructure, we are paying close attention to the implementation of the SIC, since we do not wish for the SIC to compound PT Comunicações' obligation to provide information regarding its ducts and associated infrastructure.

Between April 27, 2012, and July 20, 2012, a public consultation was held on the reduction of NGA roll-out costs, highlighting the need for more coordination, information and transparency between the different stakeholders. According to the EC, 80% of the investment costs in NGA networks relate to the deployment of civil infrastructure, as is the case of trenching and laying of ducts, and up to 30% of these costs are due to inefficiencies. The EC is of the opinion that the NGAs and the Member States may intervene at this level, making infrastructure sharing mandatory, including those of utility companies. The EC published the report on this public consultation on November 22, 2012, and proposed a draft regulation on March 26, 2013. On November 28, 2013, the ITRE Committee of the European Parliament proposed a number of amendments to the European Commission proposal, suggesting that the measures to reduce the cost of broadband deployment should be addressed through an EU directive rather than a regulation, thus giving the Member States more flexibility to adjust to specific local or national rules on this matter.

Negotiations between the European Parliament and the European Council took place in early 2014. On April 15, 2014, the European Parliament plenary adopted the measures proposed in these negotiations to reduce the costs of deploying high-speed broadband networks with no substantial amendments to the final report published by the ITRE Committee of the European Parliament on March 20, 2014. In furtherance of the foregoing, on May 15, 2014, Directive 2014/61, on measures to reduce the cost of deploying high-speed electronic communications networks, was enacted. Transposition by Member-States shall occur no later than January 1, 2016, and the provisions set forth therein shall apply from July 1, 2016.

On December 5, 2012, the EC sent its draft recommendation on NGA non-discrimination and costing methodologies to BEREC. The draft recommendation expands on the principles set out by Commissioner Kroes, in July 2012, that price orientation to costs could be more flexible in certain circumstances in return of a tighter control of non-discrimination at the wholesale level. BEREC issued its opinion on this draft recommendation on March 26, 2013, endorsing the objectives of the EC, but criticizing and asking for amendments of some aspects of the draft recommendation. According to BEREC, the recommendation should not suggest a specific costing methodology but identify the fundamental principles to be respected. The EC did not take into account the opinion of BEREC in this matter and obtained, on July 11, 2013, the favorable opinion of COCOM (Communications Committee), enabling the final adoption of the recommendation.

On September 9, 2013, the EC formally published the final recommendation on non-discrimination and NGA cost models, included in the presentation and proposal of the so-called Connected Continent package. The (non-binding) recommendation aims to promote investment and innovation in new network infrastructures, while ensuring effective competition. In particular, it seeks to: (i) ensure an effective level playing field through the application of stricter rules on non-discrimination; (ii) set predictable and stable prices for access to copper networks; and (iii) increase regulatory certainty as to the circumstances that should lead to the non-imposition of regulated prices for wholesale access to next-generation networks. The Connected Continent package was approved by the European Parliament on April 3,

2014, and this recommendation may have an adverse effect on our business. See “*Connected Continent—Legislative Package*”.

Cost Accounting System (“CAS”)

PT Comunicações runs an activity-based, fully-distributed historical cost model, first developed following the privatization of the company in 1995. The CAS is also a regulatory obligation imposed on us within the scope of our concession and relevant market regulations. Following a set of ANACOM’s determinations and recommendations concerning the improvement of PT Comunicações’ CAS and the review and resubmission of the results of the CAS for 2007, and subsequently for 2008 and 2009, PT Comunicações sent the revised results of the CAS for these years to ANACOM (in February, April and May of 2013).

On June 6, 2013, ANACOM declared the conformity of PT Comunicações’ CAS for the exercises of 2008 and 2009 with the applicable regulatory dispositions, and approved determinations and recommendations concerning the improvement of the CAS. Following a request submitted by PT Comunicações and a public consultation, ANACOM approved on December 5, 2013 the final decision concerning the methodology for the calculation of PT Comunicações’ Weighted Average Cost of Capital applicable from 2012.

In a letter dated August 29, 2013, ANACOM informed PT Comunicações of the schedules for the auditing processes to the CAS and the Net Costs of the Universal Service, (“NCUS”), for 2010 to 2012, and for the works concerning the revision of the CAS.

Compensation for the Negative Operating of the Mandatory Services

Under the fixed-line concession, PT Comunicações has the right to be directly compensated by the Portuguese government for the negative operating margins resulting from the mandatory provision of fixed telex service, fixed switched data transmission service, telegram service, broadcasting and distribution service of telecommunications broadcasting signals and maritime mobile service.

ANACOM notified PT Comunicações of the approval of the final decision concerning the reformulated results of the operational margins of fixed telex service, telegram service, broadcasting and distribution service of telecommunications and broadcasting signal and maritime mobile service for 2007 (in its letter of April 8, 2013) and for 2008 and 2009 (in its letter of June 7, 2013). The corresponding notifications were sent by ANACOM to the General Inspection of Finance. In its letter of December 9, 2013, PTC submitted to ANACOM information on the operational margins of fixed telex service, telegram service and maritime mobile service for 2012.

In 2012, we initiated an arbitral proceeding in which we challenged the Portuguese government (General Inspection of Finances) regarding the view it expressed on the subject of negative operational margins of the mandatory services in 2006. According to the General Inspection of Finances, the negative margin should be compensated after deduction of the positive margins that some of the required services may eventually present. A final arbitral ruling in favour of PTC was issued on June 16, 2014. As a result of the ruling, we are entitled to receive the negative margins of the maritime mobile service and the overall net negative margins on the analogue terrestrial television, telegraph and telex services.

Regulation on the Settlement and Collection of Regulatory Fees

According to the Administrative Rule 1473-B/2008 of December 17, 2008, all providers are subject to the payment of a regulatory fee for the provision of electronic communications networks and services, through which they cover the administrative regulatory costs of ANACOM.

By a deliberation dated July 11, 2013, ANACOM approved the report concerning its administrative costs and the amount resulting from the collection of the fees owed by the suppliers of networks and electronic telecommunication services for 2012. It was also decided to reimburse to the suppliers of networks and electronic telecommunication services a total amount of €334,316.04 for 2012, and €22,426.21 for a correction for 2011. As a result of this last correction, the contributory percentage was set at 0.5505% for 2011. For 2012, the contributory percentage was set at 0.5475%.

By a deliberation dated July 25, 2013, ANACOM determined the value of the administrative costs, to be considered for purposes of the settlement of the fees due for the exercise of the activity of supplier of networks and electronic telecommunication services, in the amount of €24.5 million in 2013.

In its letter of October 1, 2013, in reply to a request by ANACOM, PT Comunicações submitted to ANACOM the revised declarations of the relevant profits for 2007 to 2009, following the adjustments resulting from the auditing process and calculation of the final NCUS values for those three years.

ANACOM, by a deliberation dated October 19, 2013, approved the revision of the settlement of the fees due for the exercise of the activity of supplier of publicly available networks and electronic communication services for 2009 and 2010, following the correction of the value of PT Comunicações' relevant revenues, according to the final values of the net costs of the universal service for 2007 to 2009. The upwards revision of PT Comunicações' relevant revenues resulted in an increase of the total amount of relevant revenues of the companies at "level 2", with an impact in the value of the contributory percentages for 2009 and 2010, which were set at 0.4827% and 0.4908%, respectively.

On October 31, 2013, ANACOM approved the revision of the settlement of fees due for the activity of provider of publicly available networks and electronic communications services, for 2011 and 2012. This decision followed the correction of the amount of relevant revenues of PTC resulting from the final values of the net costs of universal service for the years in question, submitted to ANACOM by PT Comunicações on October 16, 2013, in accordance with Article 9, paragraph 1 of Ordinance No. 1473-B/2008 of December 17, 2008, revised by Administrative Rule No. 296-A/2013 of October 2, 2013.

By a decision dated November 21, 2013, ANACOM approved the values to be considered in the formula for calculating the fees due for the activity of provider of publicly available networks and electronic communications services, having settled the value of the contributory percentage at 0.4880% for 2013.

Universal Service Obligations

Until June 1, 2014, we had obligations as a universal service provider under the fixed-line concession for public telecommunications service. Universal services are divided into three functions: (i) connection to a public telecommunications network at a fixed location and the provision of public telephone services; (ii) publicly available telephones; and (iii) comprehensive directory and directory inquiry services. Under the tender for designation of the Universal Service Provider described below, these functions are further divided into three geographic regions: North, Center and South and Islands. On October 12, 2012, following ANACOM's decision on the designation of a universal service provider, the Portuguese Ministries of Finance, Economy and Employment launched a public tender to designate universal service providers for each of the three functions described above (referred to as Tender 1, Tender 2 and Tender 3 respectively), which included a compensation fund for universal service providers, as described below, and a related renegotiation of our concession which led to its revocation. To select the company responsible for providing a comprehensive directory and a directory inquiry service, the criterion was the highest remuneration payable to the Portuguese government. The granting period for each of the services was set at five years. Pursuant to the qualifying report issued on February 2, 2013, PTC qualified for each of the Tender 1, Tender 2 and Tender 3 categories. The deadline for the submission of proposals for each of these tenders was March 15, 2013. PT Comunicações, ZON and Optimus presented bids for Tender 1, PTC presented the only bid for Tender 2, and no bids were presented for Tender 3.

On April 18, 2013, ANACOM published a preliminary report regarding the bids for Tenders 1 and 2, as there was no bidder in Tender 3. In accordance with this report, PT Comunicações did not present the lowest bid in Tender 1 (which was the relevant criterion for this tender) and, as such, it did not qualify to be designated as the universal service provider of access to a public telecommunications network at a fixed location. PT Comunicações' services in this regard ceased on June 1, 2014. See "*—Our Concessions and Existing Licenses and Authorizations—The Fixed-line Concession*" above.

PTC submitted the lowest bid for Tender 2.

On October 18, 2013, the Portuguese government confirmed these results and determined the designation of Optimus and ZON as the universal service providers for the connection to a public electronic communications network at a fixed location and the provision of publicly available telephone services, and of PTC as the universal service provider for publicly available telephone (payphones).

In addition, on November 7, 2013, PTC was awarded by the Portuguese government with the comprehensive directory and directory inquiry services concession. See "*Our Public Payphones and Directory Services Concessions*".

Furthermore, even in the cases where PTC is the universal services provider, we will be required to contribute to the compensation fund for universal services providers according to our share of the revenues of the national telecommunications sector.

By a deliberation dated August 1, 2013, ANACOM approved the draft decision on the final results of the audit to NCUS resubmitted by PTC for 2007 to 2009: €23,584,976.93 in 2007, €20,168,431.93 in 2008 and €23,057,573.48 in 2009. This draft decision was submitted to prior hearing of the interested parties and public consultation. On September 19, 2013, ANACOM approved the final decision having maintained the values proposed on the draft decision.

On August 19, 2013, following a deliberation by ANACOM dated June 20, 2013, regarding the decision on the results of the audit to NCUS for 2007 to 2009, PTC sent to ANACOM new values for the NCUS in 2010 and 2011, according to

the final, settled methodology. According to Law 35/2012, which established the compensation fund for the universal service of electronic communications, for the financing of the NCUS, on October 31, 2013, PTC submitted to ANACOM the calculation of the NCUS for 2012, taking into account the deliberations of the Regulatory Authority concerning the methodology of calculation of the NCUS and the recommendations made in the audit of the NCUS for 2007 to 2009.

Network Security

On December 12, 2013, ANACOM approved a decision on the circumstances, format, and procedures applicable to reports regarding security breaches or loss of integrity with a significant impact on the functioning of electronic communications networks and services available to the public. This decision also sets forth the conditions under which ANACOM considers there is a public interest in disclosing information regarding those events to the public. Further, we will have to implement all the necessary measures to comply with this decision by June 12, 2014, which will require implementing new procedures and adapting information systems to produce the relevant information to notify to ANACOM.

Cloud Computing

The EC issued a review of cloud computing in Europe with the goal of enabling and facilitating its adoption throughout all sectors of the economy with the goal of cutting ICT costs and boosting productivity, growth and jobs. The EC put forward a set of measures that, in its view, are key to promoting cloud computing and ensuring users' rights.

On December 12, 2012, the Directorate General for Justice organized a workshop on cloud computing contracts, with the purpose of exploring stakeholders' experiences and views on cloud computing contracts with the EC. The EC and stakeholders discussed possible future developments of the market, issues relating to cloud computing contracts, based on existing practice, the economic impact of these issues in cloud computing contracts and the possible ways forward. The EC considered the workshop a first step to find a precise feasible mandate for an expert group that was formed in September 2013 to address cloud computing issues pertaining to fair and balanced contract terms, trust of consumers and users and increased legal certainty.

Cinema Law

Following the publication on September 6, 2012, of the Law No. 55/2012 (Cinema Law) that establishes the Portuguese government action principles in the promotion, development and protection of the art of cinema and cinematographic and audio-visual activities, which imposes obligations on television distributors and operators of video-on-demand services, two regulations of the Cinema Law were published.

Firstly, Decree Law No. 9/2013 of January 24, 2013, which foresees, among other issues, the obligation to reverse charge the annual fee for each subscription of television services by July 1 of the following year to which the data reported relates as well as the obligation to provide to the Portuguese Cinema and Audiovisual Institute (*Instituto do Cinema e do Audiovisual*), or "ICA", with the reports that were sent to ANACOM regarding the number of television services subscribers.

Secondly, Decree Law No. 124/2013 of August 30, 2013, which foresees, among other matters, the obligation to invest 1% of video-on-demand services revenues in film production and audio-visual ensured through an annual investment in national cinematographic works, the obligation to report to ICA until June 30 of each year the video-on-demand services revenues earned in the previous year, the obligation to report to ICA until January 31 of the following year to which the investment relates (i) the title, type and gender of each creative national film work object of investment, (ii) the identification of the independent producers and other author and neighboring rights holders over such works, (iii) the amount and type of investment made in each work, and (iv) the demonstration of the actual costs with the creation of an area devoted to national works and the loss of revenue by applying the conditions of remuneration of such rights holders foreseen in the Cinema Law (i.e., a 50% revenue share), subject to the demonstration that they are more disadvantaged in relation to the operator when compared with the agreed conditions with other content providers of the same type.

On October 17, 2013, we were notified by ICA of the official settlement regarding the abovementioned annual fee. Given that we believe such an annual fee to be unconstitutional, we have decided not to make any payment and to provide a bank guarantee under the tax enforcement process of which it was notified on December 5, 2013. We will also file a complaint.

Law 28/2014, of May 19, 2014, introduced certain changes regarding the Cinema Law, including (i) the reduction of the annual fee for TV subscriptions to €1.75 (to be increased up to a maximum of €2 from 2020 onwards) per subscription, and (ii) the transfer of funds from ANACOM to ICA in an amount equal to the total annual fee mentioned herein. In light of this legal change, we proceeded with the payment of the abovementioned annual fee. The bank guarantee and the tax enforcement process has thus been cancelled.

Roaming

The EC regulates the roaming charges that may be charged in the wholesale market and the retail market in Europe. These regulations extend to data and SMS, or text messaging. On July 1, 2012, the previous roaming regulations were replaced by a new version, known as “Roaming III”, which will expire on June 30, 2022. In addition to setting maximum voice roaming rates (subject to a glide path) that may be charged with respect to the wholesale market, retail market, data and SMS, Roaming III also features (i) extended transparency and consumer-protection measures (“bill-shock”) that go beyond the EU territory, (ii) a cap on retail data roaming communications, (iii) the introduction of an obligation for mobile operators in the wholesale market to provide reasonable network access in order to allow roaming services and (iv) the decoupling of roaming services from other services, while enabling a consumer to use the same number, no later than July 1, 2014.

On July 1, 2013, the new price caps, valid until July 2014, entered into force:

- For voice calls, €0.24 per minute (retail) for outgoing calls and €0.07 per minute (retail) and €0.10 per minute (wholesale) for incoming calls;
- For outgoing SMS, €0.08 (retail) and €0.02 (wholesale); and
- For data traffic, €0.45 per MB (retail) and €0.15 per MB (wholesale).

As of July 1, 2014, the price caps, valid until June 30, 2017 (retail level), and June 30, 2022 (wholesale level), if not revised before, shall be:

- For voice calls, €0.19 per minute (retail) for outgoing calls and €0.05 per minute (retail and wholesale) for incoming calls;
- For outgoing SMS, €0.06 (retail) and €0.02 (wholesale); and
- For data traffic, €0.20/MB (retail) and €0.05/MB (wholesale).

On March 18, 2013, BEREC published its guidelines on the interpretation and implementation of Roaming Regulation III, except with regard to Articles 3, 4 and 5 concerning the wholesale access and the separate sale of roaming services. Issues concerning wholesale access had already been object of specific guidelines, published on September 27, 2012, and the separate roaming services (single IMSI and LBO—Local break-out) sale was also object of specific guidance, published on July 5, 2013.

In addition, the EC’s proposed “Connected Continent” legislation could lead to the elimination of roaming charges for calls within the EU, as discussed in the next paragraph. The EC has stated that it believes roaming charges within the EU should end.

“Connected Continent” Legislative Package

The EC is finalizing its plans to pass a legislative package implementing a single telecommunications market (the so-called “Connected Continent” legislation) in order to stimulate the provision of cross-border European services. The draft legislation, in its initial wording, addresses matters such as a single European authorization and convergence of regulatory remedies, a standard EU wholesale broadband access product, the harmonization of spectrum authorization procedures, net neutrality and transparency, international mobile roaming and international calls and consumer protection.

In its latest form, the legislative package approved by the European Parliament on April 3, 2014, provides, among other things, for (i) the cancellation of retail market roaming tariffs by December 15, 2015, which would result in operators no longer being able to differentiate between retail domestic and roaming communications within EU mobile networks, (ii) clear rules for traffic management and the obligation of operators to assure a certain quality of service and (iii) reinforced consumer rights.

From June 6, 2014, the draft legislation is being discussed at the level of the European Council and may be subject to additional revisions.

Pricing of Fixed-line Telephone Services

ANACOM has established a pricing regime for fixed-line telephone services. This pricing regime creates the following regulatory obligations for the retail market for telephone services at a fixed location:

- The price of fixed-to-mobile calls (residential and non- residential) is required to be cost-oriented, and a price control is in place in the form of a cap of €0.063 on the amount retained by the fixed operator with respect to fixed-mobile calls.
- The price of off-net fixed calls is also subject to a cap corresponding to the on-net prices, corrected for the existing asymmetry between the wholesale voice calls termination rates of Portugal Telecom and other operators.
- The tariffs for domestic payphone calls are required to correspond to a maximum of three times the tariff for a residential phone call.
- A requirement to grant a 50% discount on our monthly fee for retired people, a price accessibility obligation that was included under our universal service obligations.

In addition, general regulatory obligations of transparency, non- discrimination, cost orientation, cost accounting and account separation apply to access to the fixed-line network and to the telephone services at a fixed location.

Interconnection

The Interconnection Framework. The EU Access and Interconnection Directive requires that interconnection services be made available in a non- discriminatory manner. The EU Access and Interconnection Directive encourages commercial negotiations among operators but requires national regulatory authorities to establish mechanisms for effective dispute resolution. According to the EU Access and Interconnection Directive, all telecommunications companies with significant market power in the call origination or termination markets must:

- make interconnection access to their networks available to other network operators;
- not discriminate between interconnection customers;
- provide to those requesting interconnection the information and technical specifications necessary for them to interconnect their networks;
- offer interconnection prices that are transparent and cost-oriented and do not discriminate between interconnection customers; and
- maintain a separate accounting system for interconnection activities.

The EU Access and Interconnection Directive established the general conditions for access and interconnection among telecommunications operators in competitive markets. It guarantees the rights of new entrants to obtain interconnection from telecommunications operators with significant market power. ANACOM is entitled to review and modify our proposed interconnection rates and arrangements in our reference interconnection offer. ANACOM has established an overall interconnection framework based on cost that is consistent with the EU legal framework for both wireline and mobile services.

Wireline Interconnection. ANACOM regulates call origination on fixed- telephone networks provided at a fixed location and call termination on individual public telephone networks provided at a fixed location within the scope of market analysis and significant market power designations. ANACOM has declared the Portugal Telecom group to have significant market power in these markets. As a result, we are subject to price controls in these markets based on our costs and other factors and must publish a reference offer that includes these prices and quality of service standards.

Mobile Interconnection. All mobile operators are considered to have significant market power in call termination in mobile networks market. ANACOM has imposed price controls on interconnection rates for the termination of calls on mobile networks. These reductions have had, and are expected to continue to have, a significant impact on *Meo's* interconnection revenues and consequently its earnings.

Fixed Interconnection. On March 7, 2013, ANACOM launched a public consultation regarding the draft decision on the wholesale market for voice call termination on individual public telephone networks provided at a fixed location, under which it proposed to set fixed termination rates ("FTR"), at €0.001091, corresponding to the average FTR of the

countries that had already defined their call termination rates at a fixed location based on the pure LRIC cost models recommended by the EC.

On July 12, 2013, ANACOM notified the EC of a draft decision on the same lines as the draft decision that it submitted to a public consultation in March 2013, but proposing therein an average termination rate of €0.001114, which resulted from an update to the benchmark. In the draft decision notified to the EC, ANACOM imposed on PTC an obligation to submit, within 12 months, a proposal for access and IP interconnection. However, on August 14, 2013, ANACOM decided to withdraw its draft decision as a consequence of the serious doubts raised by the EC, particularly regarding the inexistence of a symmetric obligation of IP interconnection imposed upon all operators with significant market power operators. Having taken into consideration the EC comments, on August 27, 2013, ANACOM imposed provisional and urgent measures that determined the maximum average prices to be applied by the operators designated as having significant market power:

- On October 1, 2013, 0.1114 cents per minute (the prices to be applied by PTC in the three interconnection levels were calculated taking into account the weight of traffic in each level, so that, globally, this average price is reached); and
- From July 1, 2014, the price will be set using the pure LRIC cost model.

Some operators interpreted this decision in different ways, recreating situations of tariff asymmetry, which led ANACOM to adopt new and urgent provisional measures on November 27, 2013, with effect from December 1, 2013, clarifying that if operators choose to define a simplified tariff with only one price level, that price cannot be higher than the average reference price, and that if they choose a structured tariff, with various levels of interconnection, they must provide a local interconnection price level, so that it is possible to deliver on that level the termination traffic to all customers of the operator.

On July 10, 2014, ANACOM approved (i) a draft decision regarding the definition of the fixed-termination wholesale market, the evaluation of those with significant market powers in that market and the imposition, maintenance, modification and suppression of regulatory obligations in that market, and (ii) a draft decision regarding the cost model for the fixed termination market. Pursuant to Portuguese law, both draft decisions were submitted for public consultation for a period of 30 business days. We expect a final report on the matters to be published in the near future.

ANACOM has issued successive decisions that have reduced mobile termination rates over time. The reductions in mobile termination rates have had, and will continue to have, a negative effect on our cash flows and revenues.

Pricing for Mobile Origination Rates

In January 2012, the Portuguese Competition Authority completed an analysis on mobile rates for originating calls, finding origination rates to be excessive and stating that mobile operators must reduce their rates to the level of their costs by July 2012 or face the possibility of being sanctioned. All three mobile network operators decided to reduce its mobile originating rates between €0.07 and €0.0975 and no subsequent action from the Authority is expected.

Internet Access

As a result of past ANACOM decisions, we offer two access regimes to ISPs: (i) the Reference Offer for internet Access, which includes two alternative pricing methods, primarily a monthly flat rate and a per minute origination charge, and under which the connection of the ISP's infrastructure to our fixed-line network is based on DSS1 signalling, and (ii) the Reference Interconnection Offer, which includes a pricing method based on call origination, under which the connection of the ISP's infrastructure to our fixed-line network is based on Signalling System No. 7 ("SS7") protocols. The ISPs determine which regime will apply to their arrangements to connect with our fixed-line network.

Internet and Related Services

Various regulatory developments may affect our internet business. A Data Protection Directive was adopted by the EC in 2006, that imposed data- retention obligations on operators. The law implementing this directive requires internet service providers and other electronic communications providers to preserve data for a specified period of time and imposes other obligations in this area.

Regulatory Proceedings

We are regularly involved in regulatory inquiries and investigations involving our operations. In addition, ANACOM, the EC, the Portuguese Competition Authority and ERC regularly make inquiries and conduct investigations concerning our

compliance with applicable laws and regulations. These investigations are described in more detail in “*Description of PT Portugal’s Business—Regulatory Proceedings*”.

Regulatory obligations

For both mobile and fixed telephony services, operators are obligated to ensure the effective transfer of the number within a maximum period of one business day from the presentation of the request by the subscriber before the new operator pursuant to ANACOM Regulation 114/2012 on number portability.

Under Decree Law 7/2004 of January 7, 2004, as amended, internet service providers are not liable for information transmitted over their electronic communications network provided that they are not the disclosing party of the transmitted information, do not select or modify neither the information nor its recipients. Storage providers can only become liable for unlawfully stored information provided that they become aware of the unlawful use of that information and, upon becoming aware, do not take action to remove or to disable access to the information.

Under Portuguese data protection law, it is necessary to obtain the prior consent of the user to store information and to access stored information in the user’s equipment, as well as to send unrequested communications for direct marketing purposes. Electronic communications services providers are demanded to notify the *Comissão Nacional de Protecção de Dados* in cases of breach of personal data of the users.

Consumer protection

The Consumer Protection Law establishes that debts of consumers to electronic communications services providers are subject to a six-month expiration period, starting from the moment the services were provided. Consumer protection was strengthened by Law 10/2013 of January 28, 2013, establishing rules of mandatory suspension and/or termination of the service provision in a short period of time in case the consumer fails to pay an invoice on the due date.

Fees and contributions

ANACOM collects an annual regulation fee from electronic communications services providers and other regulation fees that are directly related to its activity, such as a fee for granting the usage of certain numbers or certain frequencies. Such fees were recently revised by Administrative Rule 378-D/2013 of December 31, 2013, amending Administrative Rule 1473-B/2008 of December 17, 2008. Municipalities collect a municipal fee for rights of way (the “MFRW”), established in the 2004 Communications Law, based on the provider’s turnover concerning end users in each municipality.

We are subject to a rights-of-way regime in Portugal whereby each municipality may establish a fee, up to a maximum of 0.25% of each wireline services bill, to be paid by the customers of those wireline operators whose network infrastructures are located in each such municipality. Our exemption from municipal taxes is currently being challenged in court.

Belgium

Overview

Under Belgian law, telecommunications and broadcasting activities are regulated separately. Telecommunications include telephony and internet and are regulated by the Federal Electronic Communications Act of June 13, 2005 (ECA). Television and radio broadcasting is regulated by decrees at community level (Decree of the Flemish Community of March 27, 2009; Coordinated Decree of the French Community of March 26, 2009; Decree of the German Community of June 27, 2005; and the Act of March 30, 1995, of the Federal State for broadcasting activities in the Brussels Capital region that due to their content cannot be linked exclusively to the Flemish Community nor to the French Community).

The sector is also regulated by decisions, resolutions and recommendations of BIPT (the federal postal and telecommunication services regulator) for telecommunications, as well as of radio and television regulatory authorities at community level. In addition, network infrastructure can be subject to local planning and other regulations issued by municipalities.

Specific requirements can also be imposed on entities that are deemed, by the BIPT and/or radio and television regulatory authorities, to have a significant power in relevant markets that are not sufficiently competitive, including non-discrimination and transparency obligations with respect to access, accounting, and price (Numericable has notably been recognized as an operator with significant market power on the Brussels retail market for the distribution of television and radio services by cable).

Market Practices

Joint offers, for example of telephony services, internet services and television services, are allowed under Belgian law, provided that such offers comply with EU and national competition legislations and that they do not constitute an unfair trade market practice prohibited by the market practices and consumer protection legislation set forth under Book VI of the Economic Law Code. Network operators must also comply with all applicable consumer protection provisions set forth in this act, as well as, where applicable, other legislation, namely the Act of May 15, 2007, on the Protection of Consumers in respect of Radio Transmission Services and Radio Distribution.

Prior Notification

Under the ECA, companies must notify the BIPT electronic communications services and/or networks that they intend to provide or resale, in their own name, on the Belgian territory, as well as any change thereto.

Telephony Regulation

The ECA mandates that a minimum set of “universal services” be offered to all end-users, independently of their geographical location, at an affordable price and at a specified quality level, and contains, in addition to applicable general privacy protection regulations, several provisions that address privacy protection in the electronic communications sector, including, notably, the processing and use of traffic and location data, the confidentiality of communications, as well as the subscribers’ rights with respect to telephone directories. The BIPT may issue specific regulations, for example with respect to the allocation of numbers and radio frequencies.

Internet Regulation

In addition to the provisions of the ECA, activities of internet service providers are also subject to the e-commerce legislation set forth under Book XII of the Economic Law Code that provide that internet service providers may not be held liable for information transmitted over an electronic communications network, subject, however, to certain conditions and exceptions.

Broadcasting Regulation

The provision of radio and television broadcasting services are subject to prior notification to the relevant regulatory authority, namely the VRM, CSA and, BIPT for the Flemish Community, French Community and the Brussels Capital Region respectively. Pursuant to the Flemish and French Broadcasting Decrees as well as the Act regulating broadcasting activities in the Brussels Capital, network operators must also comply with must-carry obligations which require them to distribute specific radio stations and television channels in their respective communities. The same legislative acts also provide, in the relevant territorial areas, for a right of way for what concerns cable networks.

The Act of January 22, 1945, on economic regulation and pricing and the Ministerial Decree of April 20, 1993, regarding special regulation on prices impose on television services distributors the requirement of the Minister of Economy’s prior consent for any price increase of their basic package. Jurisdiction over the pricing regulation was transferred on July 1, 2014, to the Communities and Regions, each with respect to their competences, as part of the sixth reform of the State. The aforementioned federal legislation, however, remains applicable until the adoption and implementation of new Community and/or Regional legislation.

Pursuant to the Act of June 30, 1994, on Authors’ Rights and Neighboring Rights, cable companies must receive approval from the holders of the relevant author and related rights to distribute radio and television signals embedding protected works over their cable. A collective author society has initiated a law suit before a Brussels court to have internet service providers subject to the same regime.

Dominican Republic

Overview

The legal framework of the telecommunications sector in the Dominican Republic is set forth by General Telecommunications Law 153-98 of May 27, 1998 (“Law 153-98”), resolutions issued by the telecommunications regulator on the grounds of Law 153-98 and various decrees of the Executive Power on matters related to the National Plan of Attribution of Frequencies (“PNAF”).

The Constitution of the Dominican Republic guarantees the freedom of enterprise, trade and industry among other individual and social rights, in addition to the industry-specific legal framework. The Constitution specifically sets forth

that monopolies shall not be permitted except in favor of the Dominican State and must be created by law. The Dominican Constitution provides that the secrecy of the communication telegraphic, telephonic, cable graphic, electronic, telematics or established by another mean, shall not be breached, except by an order of a judge or competent authority, in accordance with the law. Also, the Dominican Constitution guarantees public services of radio, television, library and information networks, to allow universal access to the information.

General Telecommunications Law 153-98

Law 153-98 classifies telecommunications services as follows:

- a) Carrier services to provide the necessary capacity to transport signals between two points of termination of a defined network;
- b) Final services or teleservices to provide the complete capacity that makes communication possible among users (e.g. telephone, telex, telegraphic);
- c) Value added services to work as support carrier services, adding some characteristic or facility to the service that is being used on the ground (e.g. internet/intranet systems, voice mail, SMS, electronic mail, digital transmission of information in general);
- d) Broadcasting services: telecommunication services in which the communication takes place normally one way to various points of reception simultaneously (e.g. radio and television).

Law 153-98 provides a basic framework to regulate the installation, maintenance and operation of telecommunications networks and the rendering of telecommunications services. Law 153-98 reaffirms the “Universal Service Principle” by guaranteeing access to telecommunications services at affordable prices in low-income rural and urban areas. Law 153-98 created the “Contribution to the Development of Telecommunications” (“CDT”) consisting of a 2% tax fund for the development of the telecommunications sector that is payable by customers and collected by telecommunications providers from customers based on billings to customers for telecommunications services.

According to Law 153-98 the *Instituto Dominicano de las Telecomunicaciones* (“Indotel”) is the regulatory body created as a decentralized state entity, with operational, jurisdictional and financial autonomy, with its own patrimony and legal personality, responsible for guaranteeing the existence of sustainable, fair, and effective competition in the rendering of public telecommunications services as well as ensuring the efficient use of the public domain of the radio-electric spectrum.

Law 153-98 sets forth the responsibilities, authorities and procedures of the regulator. Indotel is made up of a Board of Directors and an Executive Director. The Board of Directors is the highest authority of Indotel, composed of five members designated by the Executive Power.

Among other management powers, Indotel administers the entrance and participation of the telecommunications service providers in the Dominican telecommunications market, and has various functions including (i) granting, expanding and revoking concessions and licenses under the conditions provided for by the laws in force, allowing the entrance of new providers of telecommunications services; (ii) managing and administering the spectrum- orbit resources, including the management of the orbital portions of the telecommunications satellites with their respective bands of frequencies, as well as the satellite orbits for Dominican satellites which may exist and coordinating their use and operation with international entities and organisms and with other countries; (iii) controlling the compliance with obligations of the concessionaires of public telecommunications services and of the users of the radio-electric spectrum, protecting the right of defense of the parties in its actions.

Law 153-98 promotes competition in all telecommunications services by enforcing the right to interconnect with existing participants and ensuring against monopolistic practices, and at the same time upholding those concessions that are operational. Law 153-98 provides that the regulator shall ensure charges are non-discriminatory, strengthening effective and sustainable competition. In case of disagreement between the parties, the regulator shall intervene by means of a motivated resolution, taking as parameters the costs, including a reasonable remuneration for the investment, calculated according to the “Regulation of tariffs and costs of the services”.

In accordance with Law 153-98 a concession granted by Indotel is required for providing public Telecommunications services to third parties, with the exceptions set forth in Law 153-98. The authorization process is governed by “Regulations governing on Concessions, Inscriptions in the Special Registries and Licenses to provide Telecommunications Services in the Dominican Republic” contained in Resolution No. 007-02, issued by the Board of Directors of Indotel (as amended by Resolution No. 129-04) (“Resolution 007- 02”).

Pursuant to Law 153-98 a license granted by Indotel shall be required for the use of the public radio-electric domain, with the exceptions set forth in the corresponding regulations. The authorization process is governed by Resolution 007-02. When concessions and licenses are required for the rendering of a public telecommunications service, they shall be granted simultaneously.

According to Law No. 153-98 the transfer, assignment, lease or granting of rights of use of any title or the creation of a lien on licenses shall be performed, under penalty of forfeiture, prior to authorization of the regulating authority, which authorization may not be denied without justified cause. The acquirer shall meet all the conditions imposed on the grantor and shall be ruled by the same obligations as the concessionaire or licensee.

Law No. 153-98 constitutes the ratifying instrument of the Fourth Protocol attached to the General Agreement on Commerce of Services (GATS) concerning negotiations on basic telecommunications of the World Trade Organization (WTO), for liberalization of telecommunication services. Law No. 153-98 provides the corresponding regulatory framework to comply with the liberalization commitments undertaken pursuant to said agreement and to guarantee the efficient provision of telecommunications services.

Law 153-98 combined with technological advances and the sustained growth of private investment promotes the development of the telecommunications sector in the Dominican Republic.

Certain Relevant Resolutions of Indotel

On the grounds of Law 153-98 Indotel issued various resolutions. Some of such resolutions regulating certain areas of telecommunications in the Dominican Republic are as follows:

- Resolution 110-12 dated August 9, 2012, by means of which Indotel's Board of Directors approved the General Regulation for Telephone Services. The principal purpose of this Regulation is to set forth a regulatory framework governing relations between the public telephone service providers and their customers and users, in all its forms (post-paid or pre-paid), regardless of the technology used to provide the service, in order to guarantee the rights of each party explicitly maintaining their respective obligations.

Resolutions 10-12 will apply to all relations between users and telephone service providers. After a public consultation process, by Resolution 003-13, dated January 22, 2013, Indotel's Board of Directors approved the modification of Articles 1, 3, 6, 12, 14.2, 14.4, 15, 18.10 to 18.13, 21, 24.1 letter (i), 25.3 and 32 of the General Regulation for Telephone Service.

The abovementioned regulation sets forth basic rights, including: (i) access to telephone services in terms of continuity, generality, equality, neutrality, transparency and quality, in accordance with the principles of the Telecommunications General Law No. 153-98; (ii) their right to choose their service provider; (iii) their right to have a phone number and numeric portability; (iv) their right to sign a contract in accordance with terms, conditions and rights set forth in this regulation; (v) their right to cancel the service in accordance with the procedure indicated in this regulation.

This regulation considers as "abusive clauses" those imposing conditions on users that affect their interests and rights, and those that are disproportionate, or contrary to the laws, regulations and standards. According to Article 14.2, abusive clauses on contracts will be unenforceable. Indotel shall require the amendment of abusive clauses such as to make them conform to reasonable standards. If telecommunications service providers do not amend the contract, Indotel may unilaterally enforce the amendment.

- Resolution No. 64-11 dated July 27, 2011, approved the bill of the National Frequency Allocation Plan (PNAF) drafted by Indotel to be submitted to the Executive Power for its final approval. Decree 520-11 dated August 25, 2011, issued by the Executive Power approved the new PNAF and repealed Decree of the Executive Power No. 518-02 dated July 5, 2002. The new PNAF approved by Decree 520-11 seeks to optimize and rationalize the use of the radio-electric spectrum to efficiently satisfy present and future frequency needs with regard to all systems, equipment and devices that send or receive radio-electric waves within the national territory. According to the PNAF, migration of services shall not restrain the correct functioning of services provided. Indotel is in charge of deciding, applying and resolving all matters arising in connection with the frequencies allocation and migration.
- Resolution No. 156-06 dated August 30, 2006, issued by the Board of Directors of Indotel, that approves the General Regulation related to Numeric Portability, among other resolutions issued by the Board of Directors of Indotel related to numeric portability.
- Resolution No. 022-05 that approves Regulation on Free and Fair Competition for the Telecommunications Sector provides that Indotel will review, authorize, object or condition the operations related to economic concentration which must be previously informed pursuant to said Regulation, in order to comply with the purposes of Law

153-98. Indotel will also investigate and impose sanctions in the cases where the information obligation of the mentioned operations is not complied with.

- Resolution No. 022-05 defines economic concentration in the telecommunications sector as a juridical transaction by means of which the structure of direct or indirect control, total or partial, of one or more providers of public telecommunications services is modified permanently and stably, for the benefit of persons that control other providers of public telecommunications services, whenever such transaction has the potential to modify the structure and functioning of the markets in the telecommunications sector in accordance with the purposes set forth in article 3 of Law No. 153-98.

The providers of public telecommunications services, as well as any other persons subject to said Regulation must previously inform Indotel of all those operations that could result in an economic concentration in the telecommunications sector in the terms therein defined, in order to previously obtain the authorization of Indotel to do so.

In addition to the obligations set forth in Resolution 007-02, relating to requirements for the authorization to transfer the rights or permits, the assessment to determine if there is any economic concentration in the telecommunications sector, will be based in its restrictive, predictable and verified effects, mainly considering certain circumstances set forth in Resolution No. 022-05.

The failure to inform and/or apply for an authorization prior to an economic concentration operation in the telecommunications sector constitutes an infringement of Resolution No. 022-05 that will result in the sanctions set forth therein.

Application for an authorization related to economic concentration must be filed pursuant to the provisions set forth in Chapter VIII of Resolution 007-02, before the Executive Director of Indotel.

- Resolution No. 160-05 dated October 13, 2005, that approves the Regulation concerning Cable Broadcasts and Other Measures, including “Must Carry” provisions;
- Resolution No. 038-11 dated May 12, 2011 that amends the General Ruling concerning Interconnection;
- Resolution No. 025-10 dated March 2, 2010, that approves the Ruling concerning Resolution of Controversies between the Telecommunications Services Providers;
- Resolution No. 151-04 that approves the Regulation concerning the Installation and Use of Common Telecommunications Infrastructures in Properties of Joint Ownership;
- Resolution No. 128-04 that approves the General Regulation concerning the Use of the Radio-Electric Spectrum;
- Resolution No. 120-04 that approves the Regulation concerning Television Broadcasting Service;
- Resolution No. 093-02 dated November 14, 2002, that amends several Articles of Resolution No. 045-02 that approved the Regulation concerning Sound Broadcasting Frequency Modulation (FM);
- Resolution No. 046-02 dated July 20, 2002, that approves the Regulation concerning Sound Broadcasting Amplitude Modulation (AM);

Trademark/Copyright Laws

From a technical standpoint, broadcasting services are essentially regulated by Law 153-98 and the regulations approved by the regulator. Now, in connection with the content of the broadcasting services, they shall be governed by the provisions of the specific legislation which regulates the social communications media and by the laws that regulate copyrights, whether they are national laws or resulting from international conventions or agreements signed and ratified by the Dominican Republic.

In the Dominican Republic, patents of invention, trademarks, service marks, commercial names, signs, logos and commercial slogans are governed by Industrial Property Law No. 20-00 dated May 8, 2000, modified by Law No.424- 06 for the Implementation of the Free Trade Agreement between the Dominican Republic, Central America and the United States (DR-CAFTA).

The Dominican Republic grants copyright protection to original literary, dramatic, musical and artistic work, under the Copyright Law No. 65-00 dated august 21, 2000, also modified by Law No.424-06 for the implementation of the free trade agreement between the Dominican Republic, Central America and the United States Of America (DR-CAFTA).

MANAGEMENT AND GOVERNANCE

The Issuers

The Senior Secured Notes Issuer was incorporated as a public limited liability company (*société anonyme*) under the laws of Luxembourg on August 17, 2012 under the name of “Altice Financing S.A.”. The registered office (*siège social*) of the Senior Secured Notes Issuer is at 3, Boulevard Royal, L-2449 Luxembourg, Grand Duchy of Luxembourg. The Senior Secured Notes Issuer’s telephone number is +352 278 58 901. The Senior Secured Notes Issuer is registered with the Luxembourg Register of Commerce and Companies under number B 171162.

The Senior Notes Issuer was incorporated as a public limited liability company (*société anonyme*) under the laws of Luxembourg on August 17, 2012 under the name of “Altice Finco S.A.”. The registered office (*siège social*) of the Senior Notes Issuer is at 3, Boulevard Royal, L-2449 Luxembourg, Grand Duchy of Luxembourg. The Senior Notes Issuer’s telephone number is +352 278 58 901. The Senior Notes Issuer is registered with the Luxembourg Register of Commerce and Companies under number B 171151.

The following table sets forth certain information regarding the members of the board of directors of the Issuers as of the date hereof. The number of directors is not subject to any maximum limit. The sole shareholder of the applicable Issuer has the authority to dismiss any director and fill any vacancy.

<u>Name</u>	<u>Age</u>	<u>Position</u>
Jérémie Bonnin	40	Chairman
Emilie Schmitz	32	Director
Laurent Godineau	41	Director

Jérémie Bonnin, 40, is a director of the Senior Notes Issuer and the Senior Secured Notes Issuer. See “—*Altice International—Senior Management*”.

Emilie Schmitz, 32, is a director of the Senior Notes Issuer and the Senior Secured Notes Issuer. Before joining Altice, Mrs Schmitz served as an accountant manager of Quilvest Luxembourg Services S.A., a corporate and trust services provider. Prior to joining Quilvest Luxembourg Services S.A. in 2013, Mrs Schmitz was a Senior Advisor at Deloitte SA (Luxembourg). She graduated from the School Robert Schuman of Metz (France) with a bachelor’s degree specializing in accountancy and management.

Laurent Godineau, 41, is a director of the Senior Notes Issuer and the Senior Secured Notes Issuer. Before joining Altice, Mr Godineau worked at Quilvest Luxembourg Services S.A., a corporate and trust services provider specialized in private equity funds. Prior to joining Quilvest Luxembourg Services SA in 2013, he served as a general manager of Centralis S.A., a corporate and trust services provider. Prior to joining Centralis S.A. in 2007, Mr. Godineau was a Senior Advisor at Alter Domus (Luxembourg). He graduated from the ESC Bretagne Brest with a master’s in Finance and Chartered Accountancy and also holds a Master of Sciences degree in International Business and Finance from the University of Reading.

The business address of the Board of Directors of both the Senior Secured Notes Issuer and the Senior Notes Issuer is 3, Boulevard Royal, L-2449 Luxembourg.

Altice International

Board of Directors

The following table sets forth certain information regarding the members of the board of directors of Altice International as of the date hereof. The number of directors is not subject to any maximum limit. The sole shareholder of Altice International has the authority to dismiss any director and fill any vacancy.

<u>Name</u>	<u>Age</u>	<u>Position</u>
Jérémie Bonnin	40	Chairman
Emilie Schmitz	32	Manager
Laurent Godineau	41	Manager

Senior Management

All of our senior management personnel named below are employees of our parent entity and devote their time as needed to conduct our business and affairs. In addition, the management teams at our various operating subsidiaries have significant experience and are responsible for the day-to-day operations of the relevant operating subsidiary.

Dexter Goei, Chief Executive Officer. Dexter joined the Group in 2009, after he worked for 15 years in investment banking. Dexter began his investment banking career with JP Morgan and joined Morgan Stanley in 1999 working in their Media & Communications Group. Over the years, Dexter has worked across all segments of the media industry in the US and EMEA region covering primarily cable, pay-TV, broadcasting, Internet, content and gaming companies eventually becoming Co-Head of Morgan Stanley's European TMT Group. Dexter is a graduate of Georgetown University's School of Foreign Service with cum laude honors.

Dennis Okhuijsen, Chief Financial Officer. Dennis joined as the CFO of the Group in September 2012. Before joining Altice, he was the Treasurer for Liberty Global. From 1993-1996, he was a senior accountant at Arthur Andersen. He joined UPC in 1996 where he was responsible for accounting, treasury and investor relations up to 2005 before joining Liberty Global. In his previous capacities, he was also responsible for financial risk management, treasury and operational financing. Dennis holds a Master of Business Economics of the Erasmus University Rotterdam.

Jérémie Bonnin, General Secretary. Jérémie joined the Group in May 2005 as Corporate Finance director prior to which he was Manager in the Transaction Services department at KPMG which he joined in 1998. At KPMG, he led several due diligence projects with a significant focus in the telecom area. Since joining the Group, he has been involved in all of Group's acquisition which have increased Group's international footprint (in France, Belgium, Luxembourg, Switzerland, Israel and the French Overseas Territories). He has a long track record of successful cross-border transactions, and in financial management in the telecom sector. As General Secretary, he also focuses on the implementation of consistent operating policies and corporate structure across the Group, where he holds various board positions. Jeremie received his engineering degree from the Institut d'Informatique d'Entreprise, in France in 1998. He also graduated from the DECF in France, equivalent to the CPA.

Max Aaron, General Counsel. Max became General Counsel of the Group in September 2013. Prior to joining the Group, Max was a partner for over 14 years at Allen & Overy focusing on capital markets and where he was one of the founding member of Allen & Overy's US law practice. Prior to joining Allen & Overy, Max worked at Shearman & Sterling in both their New York and London Offices. Consistently rated in Europe by the legal directories as one of the top practitioners in his area, Max has done transactions in over 30 countries in a wide variety of industry sectors, including telecoms, media, technology and utilities. Max received a BA from Brown University and a JD from Boston University School of Law where he was on the Law Review.

Hertzel Ozer, Chairman, HOT Telecommunication Systems Ltd. Hertzel Ozer joined HOT Telecommunication Systems Ltd. in December 2008. He served as the CEO of HOT and also served as chairman in a number of HOT subsidiaries. In April 2013 Hertzel was nominated Chairman of HOT. Hertzel has previously been employed as CEO of a number of companies in the telecommunication, retail, industry, food and consumers fields including the OSEM group (2004 - 2008), NESHER—Israel Cement Enterprises (2003-2004). Between 1997 and 2003 Hertzel served as VP Marketing, Sales, Customer Care & Business Development of BEZEQ, the Israeli telecommunications company. Hertzel holds an MBA in Business Administration, and a BA in economics and statistics from the Hebrew University in Jerusalem.

Ilan Zachi, Chief Executive Officer, HOT Telecommunication Systems Ltd. Ilan Zachi joined HOT Telecommunication Systems Ltd. in April 2010. He served as the VP for Customer Service. In June 2013, Ilan was nominated as the CEO of HOT Mobile, a subsidiary of HOT Telecommunication Systems Ltd., and, in March 2014, he was nominated as CEO of HOT Telecommunication Systems Ltd. Ilan has previously been employed in various roles in Cellcom, one of the leading Israeli cellular companies (2001-2010). Ilan holds an MBA in Business Administration from the College of Management of Rishon LeZion, and a BA in Business Administration from the Rupin Academic Center.

Jean Michel Hegesippe, Chief Executive Officer of the French Overseas Territories. Jean Michel Hegesippe founded his own company, Infotel, in 1986. Based in the French Overseas Territories, Infotel provided transaction processing services to the banking industry. In 1998, Infotel was awarded telecom licenses by the French regulatory authority to rollout fixed telecommunication networks. From 1998 to 2004, Infotel (renamed Outremer Telecom in 2000) developed fixed line telephony and DSL services and reached a total turnover of €70 million. From 2004 to 2007, Outremer Telecom rolled out five independent mobile operations in French Guiana, Martinique, Guadeloupe, La Réunion and Mayotte. Today, the company is the only quadruple play (fixed line and mobile) alternative player to Orange and Vivendi, and the third mobile operator in the French Overseas Territories. Jean Michel is an engineer in computer sciences with a master's degree and a diploma of advanced studies in information technology (Paris VII University).

The business address of the Board of Directors of Altice International is 3, Boulevard Royal, L-2449 Luxembourg.

PRINCIPAL SHAREHOLDER

Altice International, the parent company of the Group, is a wholly-owned subsidiary of Altice S.A. Altice S.A. is a public limited liability company organized under the law of the Grand Duchy of Luxembourg and its shares are listed on the Euronext Amsterdam. Altice S.A. is controlled by Mr. Patrick Drahi.

CERTAIN RELATIONSHIPS AND RELATED PARTY TRANSACTIONS

HOT Mobile Earnout

In connection with the acquisition by HOT of HOT Mobile from Altice Securities S.à r.l. (“Altice Securities”), a subsidiary of Altice and affiliate of HOT, HOT agreed to pay to the managers of HOT Mobile and an unrelated third party (“Migad”, and, together with the managers of HOT Mobile and Altice Securities, the “Earnout Recipients”) additional consideration, in an amount of NIS 450 million, which is subject to future performance targets with respect to HOT Mobile (the “Earnout”). The Earnout includes (i) a contingent future payment of NIS 225 million, paid in four equal installments of NIS 56.25 million, conditioned upon achievement of certain EBITDA targets by HOT Mobile for the years 2013 to 2016, inclusive, and (ii) a contingent future payment of NIS 225 million conditioned on achievement of 7% market share, as defined in the HOT Mobile’s mobile license, in the mobile market by 2016. There is a mechanism to reduce the payments required under the Earnout to the extent HOT Mobile is required to make payments to the Israeli Ministry of Communications pursuant to the mobile license. As of September 30, 2014, we estimate that the fair value of the Earnout is NIS 75 million and Altice Securities has pro rata rights to approximately 94% of the Earnout. Altice Securities has transferred its rights and entitlements to payments under the Earnout to the Senior Notes Issuer (the assigned rights only include such payments that would actually have been received by Altice Securities). In June 2013, HOT paid NIS 90 million under the Earnout to the Earnout Recipients in accordance with the terms of the Earnout, out of which the Senior Notes Issuer received NIS 86.4 million. Furthermore, in August and September 2013, HOT transferred NIS 4.5 million and NIS 1.5 million to Migad and to the other parties, respectively, for their share of the above consideration. No further payments have been made.

Relationships with Numericable Group

Belgium and Luxembourg

As members of the Numericable Group prior to the acquisition of Coditel Belgium and Coditel Luxembourg by Coditel Holding (the “Acquisition”), Coditel Belgium and Coditel Luxembourg relied on the Numericable Group for numerous operational functions. Our controlling shareholder Altice S.A. holds an approximately 60.3% of the voting interest in the Numericable Group.

Services Agreement

On June 30, 2011, the date of closing of the Acquisition, Coditel Holding entered into a services agreement (the “Services Agreement”) with a subsidiary of Numericable Group, Numericable SAS. Pursuant to the Services Agreement, Numericable Group will continue to provide Coditel Holding with all the services it was providing to Coditel Holding prior to the Acquisition, including, mainly:

- VoD platform services and VoD content services;
- Television, IP and voice engineering services;
- Support and assistance in purchasing hardware and devices needed for Coditel Holding operations, and in particular set-top boxes and software, modems, routers and mobile handsets, and also television and VoD content; Numericable France undertakes to use its reasonable efforts to ensure that Coditel Holding obtain the same key terms and conditions as Numericable France for these supplies, but also for IP traffic and voice, web and webmail and material reconditioning;
- Delivery of television channels’ signal and existing data flows over Numericable France’s backbone;
- Upgrade of the billing software; and
- Continued support of Coditel Holding systems currently located in Numericable France’s premises or currently supported from its systems.

In consideration of the services provided, Coditel Holding will pay to Numericable France a total of €100,000 per year. €75,000 will be paid by Coditel Belgium and €25,000 by Coditel Luxembourg. In addition, Coditel Holding, Coditel Belgium and Coditel Luxembourg will pay to Numericable France 10% of their monthly VoD revenues.

The initial term of this agreement is six years and can thereafter be renewed for consecutive one-year periods, unless prior six months’ prior written notice to the contrary by Coditel Holding or by Numericable France. In addition,

Numericable France can terminate the Services Agreement by giving six months' prior written notice in the event that Coditel Holding, Coditel Belgium or Coditel Luxembourg is acquired by a competitor of Numericable France.

Trade Mark License Agreement

On June 30, 2011, Coditel Holding and Numericable SAS also entered into a trademark license agreement (the "Trade Mark Agreement"). Pursuant to the Trade Mark Agreement, Numericable France will provide a license to Coditel Holding to use the trademark "Numericable", registered under Ma14502, exclusively in Belgium and Luxembourg in relation to the offering, promotion and commercialization of television, internet and telephone products and services. The license fee is included in the €100,000 annual fee under the Services Agreement. The Trade Mark Agreement terminates automatically on June 30, 2017, upon termination of all services under the Services Agreement or upon expiry of the Services Agreement. Numericable France may immediately terminate the Trade Mark Agreement in the event that Coditel Holding, Coditel Belgium or Coditel Luxembourg is acquired by a competitor of Numericable France.

IP and voice international call termination

Coditel Holding also entered into an agreement with Completel for the termination of Coditel Holding's IP and voice traffic. This agreement is based on Completel's general terms and conditions, including pricing.

French Overseas Territories

On October 24, 2013, Altice Blue Two SAS ("ABT"), an indirect subsidiary of Altice International and the parent of Le Cable, entered into a services agreement (the "Le Cable Services Agreement") with the Numericable Group, pursuant to which the Numericable Group agreed to provide to Le Cable certain services, including, amongst others, signal transportation services between France and the West Indies, digital television distribution, Internet and telephony services.

The Le Cable Services Agreement was entered into for an initial term expiring on December 31, 2019 at which time, absent a six-month notice by either party, the contract will be renewed for an indefinite term. From its renewal, the Le Cable Services Agreement may be terminated at any time by either party upon twelve months' notice. ABT may also terminate the Le Cable Services Agreement or any and all of the services, or any individual service, at any time, upon a one month's notice. The Le Cable Services Agreement contains a change of control provision pursuant to which it will automatically terminate in the event of a change of control of ABT or any of its affiliates, it being understood that in the event of a change of control of any ABT's affiliate(s), the Le Cable Services Agreement shall remain in effect in respect of the affiliates not concerned by the change of control.

Pursuant to the trademark licensing agreement included in the Le Cable Services Agreement, the Numericable Group granted a non-exclusive license to ABT to use the Numericable brand to market its products and services in the French Overseas Territories and the Caribbean and the Indian ocean regions. This agreement was entered into for an initial period expiring on December 31, 2019 and is automatically renewed annually, subject to the right of either party to terminate the contract upon three months' notice before the anniversary date.

Pursuant to the Le Cable Services Agreement, the Numericable Group provides the services described above to Le Cable for an annual consideration of €120,000 plus telephony costs which vary depending on the volumes of minutes and the destination of calls. The Le Cable Services Agreement also provides for specific fees for identified projects such as migration to the white label interface (€150,000) and the LaBox project (€50,000 and an annual license fee of €30,000).

Call termination fees

HOT, Wananchi and Cabovisão pay call termination fees on the Numericable Group's networks for calls made by their subscribers to subscribers of the Numericable Group's networks, and HOT, Wananchi and Cabovisão receive call termination fees from the Numericable Group for calls made by the Numericable Group's subscribers to their subscribers. The Numericable Group also provides software licenses and user interaction platform services to most of these operators. All of these services are provided on market terms.

Disposal of Valvision

On June 27, 2013, the Group disposed of its interests in Valvision, a small regional cable operator in France, a small telecommunications operator with business primarily in the cities of Audincourt, Dole, Moretau and Montbeliard with approximately 5,000 individual subscribers and 8,000 bulk subscribers, to the Numericable Group.

Auberimmo

Auberimmo rents infrastructure to the Numericable Group. Auberimmo's only client is Completel S.A.S., a Numericable Group member. The Numericable Group estimates that the rental payments correspond to the rental value of such infrastructure. For the years ended December 31, 2013, 2012 and 2011, the Numericable Group paid Auberimmo total rental payments of €1.1 million, €1.1 million and €1.0 million, respectively and for the nine months ended September 30, 2014, the Numericable Group paid Auberimmo total rental payments of an immaterial amount. We have designated Auberimmo as an unrestricted subsidiary under the terms governing over existing indebtedness.

Content Distribution Agreements

In October 2013, we acquired Ma Chaîne Sport and SportV. Ma Chaîne Sport and SportV entered into agreements with Numericable, Valvision, as well as certain of our subsidiaries, for the non-exclusive distribution of Kombat Sport, Ma Chaîne Sport, Ma Chaîne Sport Extreme, Ma Chaîne Sport Bien Etre and Ma Chaîne Sport Tennis television channels in Belgium, Luxembourg, Portugal, France, Martinique and Guadeloupe. The contracts have a duration of 5 years with retroactive effect from January 1, 2013. Pursuant to these agreements, Ma Chaîne Sport and SportV receive annual fees, which are either fixed or subject to gradual yearly increases, from each of the operators. In addition, Ma Chaîne Sport and SportV are entitled to advertising revenues received from the broadcast of their television channels. The contracts can be terminated by any party in case of a breach of the contract by the other party not remedied within 60 days.

DESCRIPTION OF OTHER INDEBTEDNESS

The following contains a summary of the terms of the 2012 Senior Secured Notes, the 2012 Senior Notes, the 2013 June Senior Notes, the 2013 December Senior Secured Notes, the 2013 December Senior Notes, the 2013 Term Loan, the Coditel Senior Facilities Agreement, the 2012 Revolving Credit Facility, the 2013 Revolving Credit Facility Agreement, the 2013 Guarantee Facility, the New Revolving Credit Facilities, the Existing HOT Unsecured Notes and the Intercreditor Agreement. It does not purport to be complete and is subject to, and is qualified in its entirety by reference to, the underlying documents. Capitalized terms not otherwise defined in this section shall, unless the context otherwise requires, have the same meanings set out in the 2012 Indentures, the 2013 June Senior Notes Indenture, the 2013 December Senior Secured Notes Indenture, the 2013 December Senior Notes Indenture, the 2013 Term Loan, the Existing Revolving Credit Facility Agreements, the New Revolving Credit Facility Agreements, the 2013 Guarantee Facility, the Existing HOT Unsecured Notes or the Intercreditor Agreement as applicable.

The 2012 Notes

On December 12, 2012 and December 20, 2012, the Senior Secured Notes Issuer issued \$460 million aggregate principal amount of its 7⁷/₈% senior secured notes due 2019 (the “2012 Dollar Senior Secured Notes”) and €210 million aggregate principal amount of its 8% senior secured notes due 2019 (the “2012 Euro Senior Secured Notes” and together with the 2012 Dollar Senior Secured Notes, the “2012 Senior Secured Notes”), and the Senior Notes Issuer issued \$425 million aggregate principal amount of its 9⁷/₈% senior notes due 2020 (the “2012 Senior Notes”, and together with the 2012 Senior Secured Notes, the “2012 Notes”).

The 2012 Senior Secured Notes

The 2012 Senior Secured Notes mature on December 15, 2019. Interest on the 2012 Senior Secured Notes is payable semi-annually in cash in arrears on each June 15 and December 15, commencing June 15, 2013.

The 2012 Senior Secured Notes are general obligations of the Senior Secured Notes Issuer and (i) rank *pari passu* in right of payment with any future indebtedness of the Senior Secured Notes Issuer that is not subordinated in right of payment to the 2012 Senior Secured Notes, (ii) rank senior in right of payment to any future indebtedness of the Senior Secured Notes Issuer that is expressly subordinated in right of payment to the 2012 Senior Secured Notes, and (iii) are effectively subordinated to any future indebtedness of the Senior Secured Notes Issuer that is secured by property or assets that do not secure the 2012 Senior Secured Notes, to the extent of the value of the property and assets securing such indebtedness.

The 2012 Senior Secured Notes are currently guaranteed on a senior basis (the “2012 Senior Secured Notes Guarantees”) by Altice International and certain of subsidiaries, including Cool Holding and SPV1, Altice Holdings, Altice West Europe, Altice Caribbean, ABO, Green, Altice Portugal, Cabovisão, Winreason, ONI S.G.P.S., Onitelecom and Knewon (the “2012 Senior Secured Notes Guarantors”). Each 2012 Senior Secured Notes Guarantee is a general obligation of the relevant 2012 Senior Secured Notes Guarantor and (i) ranks *pari passu* in right of payment with any existing and future indebtedness of the relevant 2012 Senior Secured Notes Guarantor that is not subordinated in right of payment to such 2012 Senior Secured Notes Guarantor’s 2012 Senior Secured Notes Guarantee; (ii) ranks senior in right of payment to all existing and future indebtedness of the relevant 2012 Senior Secured Notes Guarantor that is expressly subordinated in right of payment to such 2012 Senior Secured Notes Guarantor’s 2012 Senior Secured Notes Guarantee; (iii) is effectively subordinated to any existing and future indebtedness of the relevant 2012 Senior Secured Notes Guarantor that is secured by property or assets that do not secure such 2012 Senior Secured Notes Guarantor’s 2012 Senior Secured Notes Guarantee, to the extent of the value of the property and assets securing such indebtedness; and (iv) is effectively subordinated to the indebtedness and other obligations of any member of the Group that does not guarantee the 2012 Senior Secured Notes. The 2012 Senior Secured Notes Guarantees are subject to the terms of the Intercreditor Agreement. The 2012 Senior Secured Notes Guarantees are subject to release under certain circumstances. The 2012 Senior Secured Notes currently benefit from the Senior Secured Guarantees provided by the Existing Senior Secured Guarantors. Following the New Transactions, the 2012 Senior Secured Notes are expected to benefit from the Senior Secured Guarantee provided by PT Portugal and PT OpCo. See “*Corporate and Financing Structure*”.

The 2012 Senior Secured Notes are currently secured on a first-ranking basis by (i) share pledges over all of the share capital of the Senior Secured Notes Issuer and the 2012 Senior Secured Notes Guarantors (other than Winreason) (subject to the non-pledged shares of Green’s minority shareholders), (ii) a pledge over the bank accounts and all receivables of the Senior Secured Notes Issuer, including the Senior Secured Notes Issuer Pledged Proceeds Notes, (iii) subject to certain exceptions, a pledge (or an assignment, as applicable) over all of the material assets of each of the 2012 Senior Secured Notes Guarantors, including all of the share capital of HOT (other than certain minority shareholder call options and management options), (iv) a pledge over the Senior Notes Proceeds Loans, and (v) a pledge over the Cool Shareholder Loan. Following the New Transactions, the 2012 Senior Secured Notes are expected to benefit from the Senior Secured Collateral. See “*Corporate and Financing Structure*”.

Prior to December 15, 2015, the Senior Secured Notes Issuer may redeem all or a portion of the 2012 Senior Secured Notes at a price equal to 100% of the principal amount plus a “make-whole” premium. The Senior Secured Notes Issuer may redeem some or all of the 2012 Senior Secured Notes at any time on or after December 15, 2015, at a redemption price equal to their principal amount plus a premium, accrued and unpaid interest and additional amounts, if any. In addition, prior to December 15, 2015, the Senior Secured Notes Issuer may redeem up to 40% of the aggregate principal amount of each series of the 2012 Senior Secured Notes with the proceeds of certain public equity offerings at a redemption price equal to 107.875% of the principal amount of the 2012 Dollar Senior Secured Notes and 108.000% of the principal amount of the 2012 Euro Senior Secured Notes plus, in each case, accrued and unpaid interest and additional amounts, if any, to the redemption date, provided that at least 60% of the original aggregate principal amount of each series of the 2012 Senior Secured Notes remains outstanding after the redemption and the redemption occurs within 180 days after the closing of such equity offering. Upon certain Minority Shareholder Option Exercises (as defined in the 2012 Senior Secured Notes Indenture), the Senior Secured Notes Issuer must offer to repurchase the Senior Secured Notes at a price equal to 103% of the principal amount plus accrued and unpaid interest and additional amounts, if any, with the net cash proceeds of such Minority Shareholder Option Exercises. In the event there are any remaining net cash proceeds after the completion of such offer, the Senior Notes Issuer must offer to repurchase the 2012 Senior Notes at a price equal to 103% of the principal amount plus accrued and unpaid interest and additional amounts, if any, with such remaining net cash proceeds. Further, the Senior Secured Notes Issuer may redeem all of the 2012 Senior Secured Notes at a price equal to their principal amount plus accrued and unpaid interest and additional amounts, if any, upon the occurrence of certain changes in tax law. If the Covenant Parties (as defined in the 2012 Senior Secured Notes Indenture) and their respective subsidiaries sell certain of their assets, or if the Senior Secured Notes Issuer or the Covenant Parties experience specific kinds of changes in control, the Senior Secured Notes Issuer may be required to make an offer to repurchase the 2012 Senior Notes.

The 2012 Senior Secured Notes Indenture, among other things, limits the ability of the Senior Secured Notes Issuer, the ability of certain other Group entities designated as Covenant Parties and the ability of the Restricted Subsidiaries (as defined therein) to (i) incur or guarantee additional indebtedness (subject to an incurrence-based consolidated leverage ratio test, (ii) make investments or other restricted payments, (iii) create liens, (iv) sell assets and subsidiary stock, (v) pay dividends or make other distributions or repurchase or redeem our capital stock or subordinated debt, (vi) engage in certain transactions with affiliates, (vii) enter into agreements that restrict the payment of dividends by subsidiaries or the repayment of intercompany loans and advances; and (viii) engage in mergers or consolidations. These covenants are subject to a number of important exceptions and qualifications. The 2012 Senior Secured Notes permit the incurrence of senior secured indebtedness by the Senior Secured Notes Issuer so long as the consolidated senior secured leverage ratio (pro forma for such transaction) is not greater than 3.0 to 1.0. Subject to compliance with the same consolidated senior secured leverage ratio (pro forma for such transaction) and so long as there is no default or event of default outstanding, the 2012 Senior Secured Notes permits the distribution of dividends and other restricted payments so long as the aggregated amount of restricted payments does not exceed the sum of an amount equal to the consolidated EBITDA generated from the period beginning on October 1, 2012 until the most recently ended quarter, less 1.5 times the consolidated interest expense for such period. The restricted payment capacity is also subject to increase based on certain provisions that are customary for an incurrence based covenant package. In addition, unlimited restricted payments under the terms of the 2012 Senior Secured Notes are permitted so long as the consolidated leverage ratio (pro forma for such transaction) is not greater than 2.75 to 1.0.

The 2012 Senior Secured Notes Indenture provides for certain events of default, including, amongst others, defaults under other debt instruments which (i) is caused by the failure to pay principal of, or interest or premium, if any, on indebtedness at its stated maturity prior to expiration of any applicable grace period, or (ii) results in the acceleration of such indebtedness prior to its maturity, and, in each case, the principal amount of such indebtedness (together with the principal amount of any other such indebtedness under which there has been a payment default or the maturity of which has been accelerated) aggregates \$20 million or more.

The 2012 Senior Secured Notes Indenture, the 2012 Senior Secured Notes and the 2012 Senior Secured Notes Guarantees are governed by the laws of the State of New York.

The 2012 Senior Notes

The 2012 Senior Notes mature on December 15, 2020. Interest on the 2012 Senior Notes is payable semi-annually in cash in arrears on each June 15 and December 15, commencing June 15, 2013.

The 2012 Senior Notes are general obligations of the Senior Notes Issuer and (i) rank *pari passu* in right of payment with any future indebtedness of the Senior Notes Issuer that is not subordinated in right of payment to the 2012 Senior Notes, (ii) rank senior in right of payment to any future indebtedness of the Senior Notes Issuer that is expressly subordinated in right of payment to the 2012 Senior Notes, and (iii) are effectively subordinated to any future indebtedness of the Senior Notes Issuer that is secured by property or assets that do not secure the 2012 Senior Notes, to the extent of the value of the property and assets securing such indebtedness.

The 2012 Senior Notes are currently guaranteed on a senior subordinated basis (the “2012 Senior Notes Guarantees”) by Altice International and certain of its subsidiaries, including Cool Holding, SPV1, the Senior Secured Notes Issuer, Altice Holdings, Altice West Europe, Altice Caribbean, ABO, Green, Altice Portugal, Cabovisão, Winreason, ONI S.G.P.S., Onitelecom and Knewon (the “2012 Senior Notes Guarantors”). Each 2012 Senior Notes Guarantee is a general obligation of the relevant 2012 Senior Secured Notes Guarantor and (i) is subordinated in right of payment with any existing and future indebtedness of the relevant 2012 Senior Notes Guarantor that is not subordinated in right of payment to such 2012 Senior Notes Guarantor’s 2012 Senior Notes Guarantee; (ii) ranks *pari passu* in right of payment to all existing and future senior subordinated indebtedness of the relevant 2012 Senior Notes Guarantor; (iii) ranks senior in right of payment to all existing and future indebtedness of the relevant 2012 Senior Notes Guarantor that is expressly subordinated in right of payment to such 2012 Senior Notes Guarantor’s 2012 Senior Notes Guarantee; (iv) is effectively subordinated to any existing and future indebtedness of the relevant 2012 Senior Notes Guarantor that is secured by property or assets that do not secure such 2012 Senior Notes Guarantor’s 2012 Senior Notes Guarantee, to the extent of the value of the property and assets securing such indebtedness; and (v) is effectively subordinated to the indebtedness and other obligations of any member of the Group that does not guarantee the 2012 Senior Notes. The 2012 Senior Notes Guarantees are subject to the terms of the Intercreditor Agreement, including payment blockage upon a senior default and standstills on enforcement. The 2012 Senior Notes Guarantees are subject to release under certain circumstances. The 2012 Senior Notes benefit from the Senior Notes Guarantees provided by the Senior Notes Guarantors. See “*Corporate and Financing Structure*”.

The 2012 Senior Notes are currently secured by (i) a first-ranking share pledge over all of the share capital of the Senior Notes Issuer, (ii) second- ranking share pledges over all of the share capital of the 2012 Senior Secured Notes Issuer and Cool Holding, (iii) a second-ranking pledge over the Cool Shareholder Loan, and (iv) a second-ranking pledge over the 2012 Senior Notes Proceeds Loan. Following the New Transactions, the 2012 Senior Notes are expected to benefit from the Senior Notes Collateral. See “*Corporate and Financing Structure*”.

Prior to December 15, 2016, the Senior Notes Issuer may redeem all or a portion of the 2012 Senior Notes at a price equal to 100% of the principal amount plus a “make-whole” premium. The Senior Notes Issuer may redeem some or all of the 2012 Senior Notes at any time on or after December 15, 2016, at a redemption price equal to their principal amount plus a premium, accrued and unpaid interest and additional amounts, if any. In addition, prior to December 15, 2015, the Senior Notes Issuer may redeem up to 40% of the aggregate principal amount of the 2012 Senior Notes with the proceeds of certain public equity offerings at a redemption price equal to 109.875% of their principal amount plus accrued and unpaid interest and additional amounts, if any, to the redemption date, provided that at least 60% of the original aggregate principal amount of the 2012 Senior Notes remains outstanding after the redemption and the redemption occurs within 180 days after the closing of such equity offering. Further, the Senior Notes Issuer may redeem all of the 2012 Senior Notes at a price equal to their principal amount plus accrued and unpaid interest and additional amounts, if any, upon the occurrence of certain changes in tax law. If the Covenant Parties (as defined in the 2012 Senior Notes Indenture) and their respective subsidiaries sell certain of their assets, or if the Senior Notes Issuer or the Covenant Parties experience specific kinds of changes in control, the Senior Notes Issuer may be required to make an offer to repurchase the 2012 Senior Notes.

The 2012 Senior Notes Indenture, among other things, limits the ability of the Senior Notes Issuer, the ability of certain other Group entities designated as Covenant Parties and the ability of the Restricted Subsidiaries (as defined therein) to (i) incur or guarantee additional indebtedness (subject to an incurrence-based consolidated leverage ratio test, (ii) make investments or other restricted payments, (iii) create liens, (iv) sell assets and subsidiary stock, (v) pay dividends or make other distributions or repurchase or redeem our capital stock or subordinated debt, (vi) engage in certain transactions with affiliates, (vii) enter into agreements that restrict the payment of dividends by subsidiaries or the repayment of intercompany loans and advances; and (viii) engage in mergers or consolidations. These covenants are subject to a number of important exceptions and qualifications. The 2012 Senior Notes permit the incurrence of indebtedness by the Senior Notes Issuer so long as the consolidated leverage ratio (pro forma for such transaction) is not greater than 4.0 to 1.0. Subject to compliance with the same consolidated leverage ratio (pro forma for such transaction) and so long as there is not default or event of default outstanding, the 2012 Senior Notes permits the distribution of dividends and other restricted payments so long as the aggregated amount of restricted payments does not exceed the sum of an amount equal to the consolidated EBITDA generated from the period beginning on October 1, 2012 until the most recently ended quarter, less 1.5 times the consolidated interest expense for such period. The restricted payment capacity is also subject to increase based on certain provisions that are customary for an incurrence based covenant package. In addition, unlimited restricted payments under the terms of the 2012 Senior Notes are permitted so long as the consolidated leverage ratio (pro forma for such transaction) is not greater than 2.75 to 1.0.

The 2012 Senior Notes Indenture provides for certain events of default, including, amongst others, defaults under other debt instruments which (i) is caused by the failure to pay principal of, or interest or premium, if any, on indebtedness at its stated maturity prior to expiration of any applicable grace period, or (ii) results in the acceleration of such indebtedness prior to its maturity, and, in each case, the principal amount of such indebtedness (together with the

principal amount of any other such indebtedness under which there has been a payment default or the maturity of which has been accelerated) aggregates \$20 million or more.

The 2012 Senior Notes Indenture, the 2012 Senior Notes and the 2012 Senior Notes Guarantees are governed by the laws of the State of New York.

The 2013 June Senior Notes

On June 14, 2013, the Senior Notes Issuer issued €250 million aggregate principal amount of its 9% senior notes due 2023 (the “2013 June Senior Notes”).

The 2013 June Senior Notes mature on June 15, 2023. Interest on the 2013 June Senior Notes is payable semi-annually in cash in arrears on each January 15 and July 15, commencing January 15, 2014.

The 2013 June Senior Notes are general obligations of the Senior Notes Issuer and (i) rank pari passu in right of payment with any existing or future indebtedness of the Senior Notes Issuer that is not subordinated in right of payment to the 2013 June Senior Notes, (ii) rank senior in right of payment to any future indebtedness of the Senior Notes Issuer that is expressly subordinated in right of payment to the 2013 June Senior Notes, and (iii) are effectively subordinated to any future indebtedness of the Senior Notes Issuer that is secured by property or assets that do not secure the 2013 June Senior Notes, to the extent of the value of the property and assets securing such indebtedness.

The 2013 June Senior Notes benefit from guarantees from the 2013 June Senior Notes Guarantors on a senior subordinated basis and are secured by the same security applicable to the 2012 Senior Notes.

Prior to June 15, 2018, the Senior Notes Issuer may redeem all or a portion of the 2013 June Senior Notes at a price equal to 100% of the principal amount plus a “make-whole” premium. The Senior Notes Issuer may redeem some or all of the 2013 June Senior Notes at any time on or after June 15, 2018, at the redemption prices indicated below plus accrued and unpaid interest and additional amounts, if any.

In addition, prior to June 15, 2016, the Senior Notes Issuer may redeem up to 40% of the aggregate principal amount of the 2013 June Senior Notes with the proceeds of certain public equity offerings at a redemption price equal to 109.000% of their principal amount, plus accrued and unpaid interest and additional amounts, if any, to the redemption date, provided that at least 60% of the original aggregate principal amount of the 2013 June Senior Notes remains outstanding after the redemption and the redemption occurs within 180 days after the closing of such equity offering. Further, the Senior Notes Issuer may redeem all of the 2013 June Senior Notes at a price equal to their principal amount plus accrued and unpaid interest and additional amounts, if any, upon the occurrence of certain changes in tax law. If Altice International and its restricted subsidiaries sell certain of their assets or if the Senior Notes Issuer or Altice International experience specific kinds of changes in control, the Senior Notes Issuer may be required to make an offer to repurchase the 2013 June Senior Notes at specified redemption prices.

The indenture governing the 2013 June Senior Notes (the “2013 Indenture”), among other things, limits the ability of the Senior Notes Issuer, the ability of certain other Group entities and the ability of the Restricted Subsidiaries (as defined therein) to (i) incur or guarantee additional indebtedness, (subject to an incurrence based consolidated leverage ratio test), (ii) make investments or other restricted payments, (iii) create liens, (iv) sell assets and subsidiary stock, (v) pay dividends or make other distributions or repurchase or redeem our capital stock or subordinated debt, (vi) engage in certain transactions with affiliates, (vii) enter into agreements that restrict the payment of dividends by subsidiaries or the repayment of intercompany loans and advances; and (viii) engage in mergers or consolidations. These covenants are subject to a number of important exceptions and qualifications. The 2013 June Senior Notes permit the incurrence of indebtedness by the Senior Notes Issuer so long as the consolidated leverage ratio (pro forma for such transaction) is not greater than 4.0 to 1.0. Subject to compliance with the same consolidated leverage ratio (pro forma for such transaction) and so long as there is not default or event of default outstanding, the 2013 June Senior Notes permits the distribution of dividends and other restricted payments so long as the aggregated amount of restricted payments does not exceed the sum of an amount equal to the consolidated EBITDA generated from the period beginning on October 1, 2012 until the most recently ended quarter, less 1.5 times the consolidated interest expense for such period. The restricted payment capacity is also subject to increase based on certain provisions that are customary for an incurrence based covenant package. In addition, unlimited restricted payments under the terms of the 2013 June Senior Notes are permitted so long as the consolidated leverage ratio (pro forma for such transaction) is not greater than 2.75 to 1.0.

The 2013 June Senior Notes Indenture provides for certain events of default, including, amongst others, defaults under other debt instruments which (i) is caused by the failure to pay principal of, or interest or premium, if any, on indebtedness at its stated maturity prior to the expiration of the applicable grace period provided, or (ii) results in the acceleration of such indebtedness prior to its maturity, and, in each case, the principal amount of such indebtedness

(together with the principal amount of any other such indebtedness under which there has been a payment default or the maturity of which has been accelerated) aggregates €25 million or more.

The 2013 June Senior Notes Indenture, the 2013 June Senior Notes and the 2013 June Senior Notes Guarantees are governed by the laws of the State of New York.

The December 2013 Notes

On December 12, 2013, the Senior Secured Notes Issuer issued \$900 million aggregate principal amount of its 6¹/₆% senior secured notes due 2022 (the “2013 December Dollar Senior Secured Notes”) and €300 million aggregate principal amount of its 6¹/₆% senior secured notes due 2022 (the “2013 December Euro Senior Secured Notes”) and together with the 2013 December Dollar Senior Secured Notes, the “2013 December Senior Secured Notes”), and the Senior Notes Issuer issued \$400 million aggregate principal amount of its 8¹/₈ senior notes due 2022 (the “2013 December Senior Notes”, and together with the 2013 December Senior Secured Notes, the “December 2013 Notes”).

The 2013 December Senior Secured Notes

The 2013 December Senior Secured Notes mature on January 15, 2022. Interest on the 2013 December Senior Secured Notes is payable semi-annually in cash in arrears on each July 15 and January 15, commencing July 15, 2014.

The 2013 December Senior Secured Notes are general obligations of the Senior Secured Notes Issuer and (i) rank *pari passu* in right of payment with any existing or future indebtedness of the Senior Secured Notes Issuer that is not subordinated in right of payment to the 2013 December Senior Secured Notes, (ii) rank senior in right of payment to any existing or future indebtedness of the Senior Secured Notes Issuer that is expressly subordinated in right of payment to the 2013 December Senior Secured Notes, and (iii) are effectively subordinated to any existing or future indebtedness of the Senior Secured Notes Issuer that is secured by property or assets that do not secure the 2013 December Senior Secured Notes, to the extent of the value of the property and assets securing such indebtedness.

The 2013 December Senior Secured Notes are guaranteed on a senior basis by the 2012 Senior Secured Notes Guarantors (other than ABO) (the “2013 December Senior Secured Notes Guarantees”). The 2013 December Senior Secured Notes Guarantees are subject to release under certain circumstances. Following the New Transactions, the 2013 December Senior Secured Notes are expected to benefit from the Senior Secured Guarantee provided by PT Portugal and PT OpCo.

The 2013 December Senior Secured Notes are secured by (i) first-ranking pledges over all of the share capital of the Senior Secured Notes Issuer, all the 2012 Senior Secured Notes Guarantors (other than Altice International, ABO, Green, Altice Portugal, Cabovisão, Winreason, ONI S.G.P.S., Onitecom and Knewon), the capital stock of HOT and, following regulatory approval of such pledge, Tricom and ODO, (ii) a first-ranking pledge over the bank accounts and all receivables of the Senior Secured Notes Issuer, (iii) subject to certain exceptions, first-ranking pledges (or assignments, as applicable) over all of the material assets of each 2012 Senior Secured Notes Guarantor (other than ABO, Altice Portugal, Cabovisão, Winreason, ONI S.G.P.S., Onitecom and Knewon) and ODO, (iv) a first-ranking pledge over the Senior Notes Proceeds Loans, (v) a first-ranking pledge over the Cool Shareholder Loan and, (vi) a first-ranking pledge over the Covenant Party Pledged Proceeds Loan (other than the Cabovisão Proceeds Notes and the Onitecom Proceeds Notes) (collectively, the “2013 Senior Secured Collateral”). Following the New Transaction, the 2013 December Senior Secured Notes are expected to benefit from the Senior Secured Collateral. See “*Corporate and Financing Structure*”.

Prior to December 15, 2016, the Senior Secured Notes Issuer may redeem all or a portion of the 2013 December Senior Secured Notes at a price equal to 100% of the principal amount plus a “make-whole premium”. The Senior Secured Notes Issuer may redeem some or all of the 2013 December Senior Secured Notes at any time on or after December 15, 2016, at a redemption price equal to their principal amount plus a premium, accrued and unpaid interest and additional amounts, if any.

In addition, prior to December 15, 2016, the Senior Secured Notes Issuer may redeem up to 40% of the aggregate principal amount of each series of the 2013 December Senior Secured Notes with the proceeds of certain public equity offerings at a redemption price equal to 106.500% of the principal amount of the relevant 2013 Dollar Senior Secured Note and 106.500% of the principal amount of the 2013 December Euro Senior Secured Notes plus, in each case, accrued and unpaid interest and additional amounts, if any, to the redemption date, provided that at least 60% of the original aggregate principal amount of each series of the 2013 December Senior Secured Notes remains outstanding after the redemption and the redemption occurs within 180 days after the closing of such equity offering.

Upon the exercise of certain Minority Shareholder Option Exercises (as defined in the 2013 December Senior Secured Notes Indenture) the Senior Secured Notes Issuer must offer to repurchase the 2013 December Senior Secured Notes at a price equal to 103% of the principal amount plus accrued and unpaid interest and additional amounts, if any, with the net cash proceeds of such Minority Shareholder Call Options Exercises. In the event there are any remaining net cash

proceeds after the completion of such offer, the Senior Secured Notes Issuer must offer to repurchase the 2013 December Dollar Senior Secured Notes and the 2013 December Senior Notes at a price equal to 103% of the principal amount plus accrued and unpaid interest and additional amounts, if any, with such remaining net cash proceeds. Further, the Senior Secured Notes Issuer may redeem all of the 2013 December Senior Secured Notes at a price equal to their principal amount plus accrued and unpaid interest and additional amounts, if any, upon the occurrence of certain changes in tax law. If Altice International and its respective subsidiaries sell certain of their assets, or if the Senior Secured Notes Issuer or Altice International experience specific kinds of changes in control, the Senior Secured Notes Issuer may be required to make an offer to repurchase the 2013 December Senior Secured Notes at specified redemption prices.

The indenture governing the 2013 December Senior Secured Notes (the “2013 December Senior Secured Notes Indenture”) among other things, limits the ability of the Senior Secured Notes Issuer and the ability of the other subsidiaries of Altice International (other than Altice Finco) to (i) incur or guarantee additional indebtedness (subject to an incurrence-based consolidated leverage ratio test, (ii) make investments or other restricted payments, (iii) create liens, (iv) sell assets and subsidiary stock, (v) pay dividends or make other distributions or repurchase or redeem our capital stock or subordinated debt, (vi) engage in certain transactions with affiliates, (vii) enter into agreements that restrict the payment of dividends by subsidiaries or the repayment of intercompany loans and advances; and (viii) engage in mergers or consolidations. These covenants are subject to a number of important exceptions and qualifications. The 2013 December Senior Secured Notes permit the incurrence of senior secured indebtedness by the Senior Secured Notes Issuer so long as the consolidated senior secured leverage ratio (pro forma for such transaction) is not greater than 3.0 to 1.0. Subject to compliance with the same consolidated senior secured leverage ratio (pro forma for such transaction) and so long as there is not default or event of default outstanding, the 2013 December Senior Secured Notes permits the distribution of dividends and other restricted payments so long as the aggregated amount of restricted payments does not exceed the sum of an amount equal to the consolidated EBITDA generated from the period beginning on October 1, 2012 until the most recently ended quarter, less 1.5 times the consolidated interest expense for such period. The restricted payment capacity is also subject to increase based on certain provisions that are customary for an incurrence based covenant package. In addition, unlimited restricted payments under the terms of the 2013 December Senior Secured Notes are permitted so long as the consolidated leverage ratio (pro forma for such transaction) is not greater than 3.0 to 1.0.

The 2013 December Senior Secured Notes Indenture provides for certain customary events of default, including, amongst others, defaults under other debt instruments which (i) is caused by the failure to pay principal of, or interest or premium, if any, on indebtedness at its stated maturity prior to expiration of any applicable grace period, or (ii) results in the acceleration of such indebtedness prior to its maturity, and, in each case, the principal amount of such indebtedness (together with the principal amount of any other such indebtedness under which there has been a payment default or the maturity of which has been accelerated) aggregates €25 million or more.

The 2013 December Senior Secured Notes Indenture, the 2013 December Senior Secured Notes and the related guarantees are governed by the laws of the State of New York.

The 2013 December Senior Notes

The 2013 December Senior Notes mature on June 15, 2024. Interest on the 2013 December Senior Notes is payable semi-annually in cash in arrears on each January 15 and July 15, commencing January 15, 2014.

The 2013 December Senior Notes are general obligations of the Senior Notes Issuer and (i) rank *pari passu* in right of payment with any existing or future indebtedness of the Senior Notes Issuer that is not subordinated in right of payment to the 2013 December Senior Notes, (ii) rank senior in right of payment to any future indebtedness of the Senior Notes Issuer that is expressly subordinated in right of payment to the 2013 December Senior Notes, and (iii) are effectively subordinated to any existing or future indebtedness of the Senior Notes Issuer that is secured by property or assets that do not secure the 2013 December Senior Notes, to the extent of the value of the property and assets securing such indebtedness.

The 2013 December Senior Notes benefit from the 2012 Senior Notes Guarantors (except ABO) on a senior subordinated basis and are secured by the same security applicable to the 2012 Senior Notes.

Prior to December 15, 2018, the Senior Notes Issuer may redeem all or a portion of the 2013 December Senior Notes at a price equal to 100% of the principal amount plus a make-whole premium. The Senior Secured Notes Issuer may redeem some or all of the 2013 December Senior Notes at any time on or after December 15, 2018, at a redemption price equal to their principal amount plus a premium, accrued and unpaid interest and additional amounts, if any.

In addition, prior to December 15, 2016, the Senior Notes Issuer may redeem up to 40% of the aggregate principal amount of the 2013 December Senior Notes with the proceeds of certain public or private equity offerings at a redemption price equal to 108.125% of their principal amount, plus accrued and unpaid interest and additional amounts,

if any, to the redemption date, provided that at least 60% of the original aggregate principal amount of the 2013 December Senior Notes remains outstanding after the redemption and the redemption occurs within 180 days after the closing of such equity offering. Further, the Senior Notes Issuer may redeem all of the 2013 December Senior Notes at a price equal to their principal amount plus accrued and unpaid interest and any additional amount. If Altice International and its restricted subsidiaries sell certain of their assets or if the Senior Notes Issuer or Altice International experience specific kinds of changes in control, the Senior Notes Issuer may be required to make an offer to repurchase the 2013 December Senior Notes at specified redemption prices.

The indenture governing the 2013 December Senior Notes (the “2013 December Senior Notes Indenture”), among other things, limits the ability of Altice International and its subsidiaries to (i) incur or guarantee additional indebtedness (subject to an incurrence based consolidated leverage ratio test), (ii) make investments or other restricted payments, (iii) create liens, (iv) sell assets and subsidiary stock, (v) pay dividends or make other distributions or repurchase or redeem our capital stock or subordinated debt, (vi) engage in certain transactions with affiliates, (vii) enter into agreements that restrict the payment of dividends by subsidiaries or the repayment of intercompany loans and advances; and (viii) engage in mergers or consolidations. These covenants are subject to a number of important exceptions and qualifications. The 2013 December Senior Notes permit the incurrence of indebtedness by the Senior Notes Issuer so long as the consolidated leverage ratio (pro forma for such transaction) is not greater than 4.0 to 1.0. Subject to compliance with the same consolidated leverage ratio (pro forma for such transaction) and so long as there is not default or event of default outstanding, the 2013 December Senior Notes permits the distribution of dividends and other restricted payments so long as the aggregated amount of restricted payments does not exceed the sum of an amount equal to the consolidated EBITDA generated from the period beginning on October 1, 2012 until the most recently ended quarter, less 1.5 times the consolidated interest expense for such period. The restricted payment capacity is also subject to increase based on certain provisions that are customary for an incurrence based covenant package. In addition, unlimited restricted payments under the terms of the 2013 December Senior Notes are permitted so long as the consolidated leverage ratio (pro forma for such transaction) is not greater than 3.0 to 1.0.

The 2013 December Senior Notes Indenture provides for certain events of default, including, amongst others, defaults under other debt instruments which (i) is caused by the failure to pay principal of, or interest or premium, if any, on indebtedness at its stated maturity prior to the expiration of the applicable grace period, or (ii) results in the acceleration of such indebtedness prior to its maturity, and, in each case, the principal amount of such indebtedness (together with the principal amount of any other such indebtedness under which there has been a payment default or the maturity of which has been accelerated) aggregates €25 million or more.

The 2013 Indenture, the 2013 December Senior Notes and the related guarantees are governed by the laws of the State of New York.

The 2013 Term Loan

On June 24, 2013 a senior secured term loan credit facility (as amended from time to time, the “2013 Term Loan Facility”) which provide for U.S. dollar term loans (the “2013 Term Loans”) in an aggregate principal amount equivalent to \$1,034 million, was entered into among the Senior Secured Notes Issuer, as borrower, certain lenders party thereto, Goldman Sachs International, Morgan Stanley Senior Funding, Inc., Crédit Agricole Corporate and Investment Bank, Credit Suisse AG, Cayman Islands Branch and Deutsche Bank Securities Inc., as joint lead arrangers and bookrunners, Goldman Sachs Lending Partners LLC, as administrative agent and Citibank, N.A., London Branch as security agent (the “2013 Term Loan Agreement”). The entire amount available under the 2013 Term Loan has been drawn.

Interest Rate and Fees

Borrowings under the 2013 Term Loan Facility bear interest at a rate per annum equal to an applicable margin plus, at the Senior Secured Notes Issuer’s option, either (a) a base rate determined by reference to the highest of (1) the U.S. Federal Funds Effective Rate as published by the Federal Reserve Bank of New York plus 0.50%, (2) the rate of interest per annum quoted in the print edition of The Wall Street Journal, Money Rates Section as the prime rate, (3) the LIBOR rate determined by reference to the costs of funds for U.S. dollar deposits for an interest period of one month adjusted for certain additional costs, plus 1.00% and (4) a floor of 2.00% (any such borrowing, an “ABR Loan”) or (b) a LIBOR rate determined by reference to the costs of funds for U.S. dollar deposits for the interest period relevant to such borrowing adjusted for certain additional costs, provided that such LIBOR rate shall not be lower than 1.00% (any such borrowing, a “Eurodollar Loan”).

The applicable margin is, for any day, (a) with respect to any ABR Loan, 3.50% per annum and (b) with respect to any Eurodollar Loan, 4.50% per annum.

Mandatory Prepayments

The 2013 Term Loan Agreement requires the Senior Secured Notes Issuer to prepay outstanding term loans thereunder, subject to certain exceptions, with (i) 100% of the net cash proceeds in excess of a specified threshold amount of certain asset sales, subject to reinvestment rights and certain other exceptions; (ii) commencing with the fiscal year ended December 31, 2014, 50% of the annual excess cash flow, which percentage will be reduced to 0% if the Consolidated Leverage Ratio is less than 4.0:1.0; and (iii) 100% of the net cash proceeds in excess of a specified threshold amount of certain Minority Shareholder Option Exercises (as defined in the 2013 Term Loan Agreement) at, in the case of such Minority Shareholder Option Exercise prepayments, a price for such term loans prepaid equal to 103% of the principal amount thereof plus accrued and unpaid interest and additional amounts, if any.

Voluntary Prepayments

Prepayments of the 2013 Term Loan Facility on or prior to the first anniversary of July 2, 2013, are subject to a make-whole provision and a minimum call premium of 2.00%. Voluntary prepayments (including any effective prepayment by way of a repricing amendment) of the 2013 Term Loan Facility after July 2, 2014, but on or prior to July 2, 2015, are subject to a call premium of 2.00%. Voluntary prepayments (including any effective prepayment by way of a repricing amendment) of the 2013 Term Loan Facility after July 2, 2015, but on or prior to July 2, 2016, are subject to a call premium of 1.00%. Otherwise, the 2013 Term Loan Facility may be voluntarily prepaid at any time subject to customary “breakage” costs with respect to Eurodollar Loans.

Amortization and Final Maturity

Beginning with the quarter ending March 31, 2014, the Senior Secured Notes Issuer is required to make scheduled quarterly payments each equal to 0.25% of the original principal amount of the term loans borrowed under the 2013 Term Loan Facility, with the balance expected to be due on July 2, 2019.

Guarantees

Each of the 2012 Senior Secured Notes Guarantors of the 2012 Senior Secured Notes guarantees, on a senior basis, the obligations of each other obligor under the 2013 Term Loan Agreement and related finance documents.

Security

The 2013 Term Loan Facility is secured by the same collateral securing, inter alia, the Existing Senior Secured Notes.

Certain Covenants and Events of Default

The 2013 Term Loan Agreement includes negative covenants that, among other things and subject to certain significant exceptions and qualifications, limit our ability and the ability of our restricted subsidiaries to: (i) incur or guarantee additional Indebtedness, subject to an incurrence-based consolidated leverage ratio test, (ii) make investments or other restricted payments, (iii) create liens, (iv) sell assets and subsidiary stock, (v) pay dividends or make other distributions or repurchase or redeem our capital stock or subordinated debt, (vi) engage in certain transactions with affiliates, (vii) enter into agreements that restrict the payment of dividends by subsidiaries or the repayment of intercompany loans and advances; and (viii) engage in mergers or consolidations. The 2013 Term Loan Agreement permits the incurrence of senior secured indebtedness by the Senior Secured Notes Issuer so long as the consolidated senior secured leverage ratio (pro forma for such transaction) is not greater than 3.0 to 1.0. Subject to compliance with the same consolidated senior secured leverage ratio (pro forma for such transaction) and so long as there is no default or event of default outstanding, the 2013 Term Loan Agreement permits the distribution of dividends and other restricted payments so long as the aggregated amount of restricted payments does not exceed the sum of an amount equal to the consolidated EBITDA generated from the period beginning on October 1, 2012 until the most recently ended quarter, less 1.5 times the consolidated interest expense for such period. The restricted payment capacity is also subject to increase based on certain provisions that are customary for an incurrence based covenant package. In addition, unlimited restricted payments under the terms of the 2013 Term Loan Agreement are permitted so long as the consolidated leverage ratio (pro forma for such transaction) is not greater than 2.75 to 1.0.

The 2013 Term Loan Agreement also contains certain customary representations and warranties, affirmative covenants and events of default (including, among others, an event of default upon a change of control). If an event of default occurs, the lenders under the 2013 Term Loan Facility will be entitled to take various actions, including the acceleration of amounts due under the 2013 Term Loan Facility and all actions permitted to be taken by a secured creditor, subject to the Intercreditor Agreement.

The New Term Loan

Overview

On January 30, 2015, the Senior Secured Notes Issuer entered into a senior secured term loan credit facility (the “New Term Loan”) which provides euro and U.S. dollar term loans in an aggregate principal amount equivalent to €841 million, with the Senior Secured Notes Issuer as borrower (the “Term Loan Borrower”), certain lenders party thereto and Deutsche Bank AG, London Branch and Deutsche Bank AG, New York Branch as the administrative agents and Citibank N.A., London Branch as the security agent (the “New Term Loan Agreement”). The New Term Loan Agreement permits the Term Loan Borrower, upon prior notice to the lenders thereunder, to draw term loans up to the committed principal amount on a single occasion prior to June 9, 2016. Availability of the New Term Loan on such date is subject to specified conditions precedent. Proceeds of the term loans, together with the other sources of funds described under “*Use of Proceeds*,” will be used to finance a portion of the New Transactions and related fees and expenses.

The Senior Secured Notes Issuer drew under the New Term Loan on February 4, 2014. Amounts drawn have been deposited into an escrow account and used on the Completion Date.

Interest Rate and Fees

Borrowings under the New Term Loan bear interest at a rate per annum equal to an applicable margin plus (i) in the case of U.S. dollar denominated loans, at our option, either (a) a base rate determined by reference to the highest of (1) the U.S. Federal Funds Effective Rate as published by the Federal Reserve Bank of New York plus 0.50%, (2) the prime rate determined from time to time by Deutsche Bank AG, New York Branch as the prime rate, (3) the LIBOR rate determined by reference to the costs of funds for U.S. dollar deposits for an interest period of one month adjusted for certain additional costs, plus 1.00% and (4) a floor of 2.00% or (b) a LIBOR rate equal to the greater of (A) a rate determined by reference to the costs of funds for U.S. dollar deposits for the interest period relevant to such borrowing adjusted for certain additional costs, and (B) 1.00%, and (ii) in the case of euro- denominated loans, a EURIBOR rate determined by reference to the costs of funds for euro deposits for the interest period relevant to such borrowing adjusted for certain additional costs, provided that such EURIBOR rate shall not be less than 1.00%.

The applicable margin shall mean, for any day, (a) with respect to any alternative base rate loan, 3.25% per annum, (b) with respect to any Eurodollar loan, 4.25% per annum and (c) with respect to any Euro denominated loan, 4.25% per annum.

In addition to paying interest on outstanding principal under the New Term Loan, we are required to pay a ticking fee to the lenders in respect of the unutilized commitments thereunder, payable on the date of each drawing and upon any reduction or termination of the commitments.

Mandatory Prepayments

The New Term Loan Agreement requires us to prepay outstanding term loans, subject to certain exceptions, with (i) 100% of the net cash proceeds of certain asset sales, subject to thereunder reinvestment rights and certain other exceptions; and (ii) commencing with the later of (a) the fiscal year ended December 31, 2015 or (b) the first full fiscal year ended after the Completion Date, provided that if the Completion Date is after June 30, 2015, such period shall commence with the fiscal year ending December 31, 2016, 50% of our annual excess cash flow, which percentage will be reduced to 0% if our Consolidated Net Leverage Ratio is less than 4.5:1.0. We will not be required to make any such prepayments from the proceeds of asset sales made as a consequence of competition laws to the extent that such proceeds do not exceed 2% of the pro forma total assets of Altice International and its Restricted Subsidiaries.

Voluntary Prepayments

Prepayments of the New Term Loan on or prior to the six month anniversary of the closing date of the New Term Loan which are either (x) in connection with a Repricing Transaction (as defined in the New Term Loan) or (y) effects any amendment of the New Term Loan resulting in a Repricing Transaction, are subject to a call premium payable to the Administrative Agent on behalf of the lenders of, in the case of (x) 1% of the principal amount of the New Term Loan so repaid and in the case of (y) a payment equal to 1% of the aggregate amount of the New Term Loan subject to such Repricing Transaction.

Amortization and Final Maturity

Beginning with the first full fiscal quarter of Altice International after the Commitment Termination Date or, if earlier, the first date after the occurrence of the PT Portugal Acquisition, we will be required to make scheduled quarterly

payments each equal to 0.25% of the original principal amount of the term loans borrowed under the New Term Loan, with the balance expected to be due on the sixth anniversary of the completion date.

Guarantees

Each Guarantor of the New Senior Secured Notes and the Senior Secured Notes Issuer guarantees, on a senior basis, the obligations of each other obligor under the New Term Loan Agreement and related finance documents subject to applicable guarantee limitations specified therein.

Security

The New Term Loan is secured by the same collateral securing, *inter alia*, the New Senior Secured Notes (other than any security over the proceeds of the New Senior Secured Notes in any escrow accounts).

Certain Covenants and Events of Default

The New Term Loan Agreement includes negative covenants that substantially reflect the covenants contained in the indenture governing the New Senior Secured Notes, and, among other things and subject to certain significant exceptions and qualifications, limit our ability and the ability of our restricted subsidiaries to: (i) incur or guarantee additional Indebtedness, subject to an incurrence based Consolidated Net Leverage Ratio test, (ii) make investments or other restricted payments, (iii) create liens, (iv) sell assets and subsidiary stock, (v) pay dividends or make other distributions or repurchase or redeem our capital stock or subordinated debt, (vi) engage in certain transactions with affiliates, (vii) enter into agreements that restrict the payment of dividends by subsidiaries or the repayment of intercompany loans and advances; and (viii) engage in mergers or consolidations.

The New Term Loan Agreement also contains certain customary representations and warranties, affirmative covenants and events of default (including, among others, an event of default upon a change of control trigger event). If an event of default occurs, the lenders under the New Term Loan will be entitled to take various actions, including the acceleration of amounts due under the New Term Loan and all actions permitted to be taken by a secured creditor, subject to the Intercreditor Agreement.

Following the New Transactions, the New Term Loan will permit the incurrence of indebtedness so long as the consolidated net leverage ratio (pro forma for such transaction) is not greater than 4.0 to 1.0 and such indebtedness may be secured if the consolidated net leverage ratio (pro forma for such transaction) is not greater than 3.0 to 1.0. Subject to compliance with the 4.0 to 1.0 consolidated net leverage ratio (pro forma for such transactions) and so long as there is no default or event of default outstanding, the New Term Loan Agreement permits the distribution of dividends and other restricted payments so long as the aggregated amount of restricted payments does not exceed the sum of an amount equal to the consolidated EBITDA generated from the period beginning on the first full fiscal quarter commencing prior to the Issue Date until the most recently ended quarter, less 1.5 times the consolidated interest expense for such period. The restricted payment capacity is also subject to increase based on certain provisions that are customary for an incurrence based covenant package. In addition, unlimited restricted payments under the terms of the New Term Loan Agreement are permitted so long as the consolidated leverage ratio (pro forma for such transaction) is not greater than 4.0 to 1.0.

For so long as no default or event of default is outstanding under the relevant debt instrument, and while Altice International or a parent of Altice International is a public company, Altice International will also be permitted to pay dividends in an annual amount not to exceed (A) the greater of (i) 6% of the net cash proceeds received by Altice International from certain public equity offerings and (ii) the greater of 5% of the market capitalization of Altice S.A. at the time of its initial public offering and 5% of market capitalization of Altice S.A. at the time of the dividend, less (B) the amount of dividends or distributions paid pursuant to the preceding sentence, provided that dividends may only be paid in respect of this sentence if the consolidated net leverage ratio of Altice International is 4.0x or less and provided further that the net proceeds of any such dividend are used to fund a corresponding dividend in equal or greater amount on the capital stock of such parent.

The Coditel Senior Facilities Agreement

The Coditel Senior Facilities Agreement consists of an aggregate of €150 million of senior facilities and was entered into on November 29, 2011, between, among others, Coditel Holding Lux S.à r.l. as the parent, Coditel Holding S.A. as the company and the original borrower, ING Bank N.V. as agent and security agent. On July 2, 2013 Altice Holdings purchased all of the remaining interests of the lenders under the Coditel Senior Facilities Agreement (the “Coditel Refinancing”). As of September 30, 2014, the total amount of the Coditel Senior Facility outstanding was €131 million.

The Existing Revolving Credit Facility Agreements and the 2013 Guarantee Facility

The Existing Revolving Credit Facility Agreements

The Existing Revolving Credit Facility Agreements are comprised of: (1) a \$80 million revolving facility (as amended from time to time, the “2012 Revolving Credit Facility”) agreement entered into on November 27, 2012, between, among others, the Senior Secured Notes Issuer, as borrower and guarantor, certain lenders party thereto, BNP Paribas, Crédit Agricole Corporate and Investment Bank, Credit Suisse AG, London Branch, Goldman Sachs Bank USA, HSBC Bank plc, ING Bank N.V., J.P. Morgan Limited and Morgan Stanley Bank International Limited as mandated lead arrangers, Citibank International Plc as facility agent and Citibank, N.A., London Branch as Security Agent (the “2012 Revolving Credit Facility Agreement”), and (2) a €80 million revolving facility (as amended from time to time, the “2013 Revolving Credit Facility”, together with the 2012 Revolving Credit Facility, the “Existing Revolving Credit Facilities”) agreement entered into on July 1, 2013, between, among others, the Senior Secured Notes Issuer, as borrower and guarantor, certain lenders party thereto, Goldman Sachs Bank USA, Morgan Stanley Bank International Limited, Crédit Agricole Corporate and Investment Bank, Credit Suisse AG, London Branch, Deutsche Bank AG, London Branch and ING Bank N.V. as mandated lead arrangers, Citibank International Plc as Facility Agent and Citibank, N.A., London Branch as security agent (the “2013 Revolving Credit Facility Agreement” and together with the 2012 Revolving Credit Facility Agreement, the “Existing Revolving Credit Facility Agreements”). Each Existing Revolving Credit Facility Agreement provides for the accession of additional borrowers and guarantors subject to the requirements set out therein. References to the “borrower”, “borrowers”, “guarantor” or “guarantors” under this section refer to the Senior Secured Notes Issuer and any additional borrowers or guarantors (as applicable) who accede to the Existing Revolving Credit Facility Agreements in that capacity.

Structure of the Existing Revolving Credit Facility Agreements

The final maturity date of the 2012 Revolving Credit Facility Agreement is the earlier of (i) the date falling five years after December 27, 2012 (the “2012 Transaction Completion Date”) and (ii) the date on which the 2012 Revolving Credit Facility has been fully repaid and cancelled. The final maturity date of the 2013 Revolving Credit Facility Agreement is the earlier of (i) the date falling five years after July 2, 2013 (the “2013 Release Date”) and (ii) the date on which the 2013 Revolving Credit Facility has been fully repaid and cancelled. The borrowers are permitted to make drawdowns under the Existing Revolving Credit Facility Agreements for terms of, at the relevant borrower’s election, one, two, three or six months (or any other period agreed by the Senior Secured Notes Issuer and the relevant lenders), but no such period shall end beyond the final maturity date of the relevant Revolving Credit Facility Agreement. Drawdowns under the Existing Revolving Credit Facility Agreements must be repaid at the end of the interest period for the relevant loan and repaid amounts may be re borrowed up to one month prior to the final maturity date (save for certain roll over loans).

Limitations on Use of Funds

The Existing Revolving Credit Facilities and the 2013 Guarantee Facility (defined below) may be used by the borrowers for general corporate and working capital purposes of the Restricted Group, including, but not limited to, the refinancing of all or part of any existing financial indebtedness of the Restricted Group.

The commitments under the 2013 Revolving Credit Facility may be increased by up to an additional maximum amount of \$80 million euro equivalent, provided that an amount equal to any such increase is simultaneously cancelled under the 2012 Revolving Credit Facility.

The 2013 Guarantee Facility

A guarantee facility agreement for an amount of up to €15 million (the “2013 Guarantee Facility”) was entered into on July 1, 2013 (as amended from time to time), by, among others, the Senior Secured Notes Issuer, as borrower and guarantor, certain lenders party thereto, Goldman Sachs Bank USA, Morgan Stanley Bank International Limited, Crédit Agricole Corporate and Investment Bank, Credit Suisse AG, London Branch, Deutsche Bank AG, London Branch and ING Bank N.V. as mandated lead arrangers, Wilmington Trust (London) Limited as Facility Agent and Citibank, N.A., London Branch as security agent (“2013 Guarantee Facility Agreement”). The 2013 Guarantee Facility has been made available to the borrowers for general corporate and working capital purposes of the Restricted Group, including, but not limited to, the refinancing of all or part of any existing financial indebtedness of the Restricted Group. The 2013 Guarantee Facility Agreement provides for the accession of additional borrowers and guarantors subject to the requirements set out therein. References to the “borrower”, “borrowers”, “guarantor” or “guarantors” under this section refer to the Senior Secured Notes Issuer and any additional borrowers or guarantors (as applicable) who accede to the 2013 Guarantee Facility Agreement in that capacity.

Structure of the 2013 Guarantee Facility

The final maturity date of the 2013 Guarantee Facility is the earlier of (i) the date falling five years after the 2013 Release Date and (ii) the date on which the 2013 Guarantee Facility has been repaid and cancelled in full.

Conditions to Borrowings

Drawdowns under the Existing Revolving Credit Facility Agreements and the 2013 Guarantee Facility Agreement are subject to certain customary conditions precedent on the date the drawdown is requested and on the drawdown date including the following (in the case of the Existing Revolving Facility Agreements): (i) no default continuing or occurring as a result of that drawdown; and (ii) certain representations and warranties specified in the Existing Revolving Credit Facility Agreements being true in all material respects.

Interest Rates and Fees

The interest rate on each loan under the Existing Revolving Credit Facility Agreements for each interest period is equal to the aggregate of: (x) the applicable margin; (y) (i) LIBOR, in respect of the 2012 Revolving Credit Facility Agreement, and (ii) LIBOR, or, in relation to any loan in Euro, EURIBOR, in respect of the 2013 Revolving Credit Facility Agreement; and (z) any mandatory cost (which is the cost of compliance with reserve asset, liquidity, cash margin, special deposit or other like requirements).

The initial margin under the 2012 Revolving Credit Facility Agreement is 4.25% per annum but if: (i) no event of default has occurred and is continuing under the 2012 Revolving Credit Facility Agreement; (ii) at least twelve months have elapsed since the 2012 Transaction Completion Date, then the margin will be adjusted depending on the Consolidated Leverage Ratio (as defined in the 2012 Revolving Credit Facility Agreement) of the Restricted Group so that: (a) if the Consolidated Leverage Ratio is greater than or equal to 3.0:1, the applicable margin under the 2012 Revolving Credit Facility Agreement will be 4.25% per annum; (b) if the Consolidated Leverage Ratio is less than 3.0:1 but greater than or equal to 2.0:1, the applicable margin under the 2012 Revolving Credit Facility Agreement will be 3.75% per annum; and (c) if the Consolidated Leverage Ratio is less than 2.0:1, the applicable margin under the 2012 Revolving Credit Facility Agreement will be 3.25% per annum. The margin under the 2013 Revolving Credit Facility Agreement is 3.50% per annum. The margin under the 2013 Guarantee Facility is 3.50% per annum.

Interest under the Existing Revolving Credit Facility Agreements accrues daily from and including the first day of an interest period and is payable on the last day of each interest period (unless the interest period is longer than six months, in which case interest is payable on the last day of each six month period) and is calculated on the basis of a 360 day year. With respect to any available but undrawn amounts under the Existing Revolving Credit Facility Agreements and the 2013 Guarantee Facility, the borrowers are obligated to pay a commitment fee on such undrawn amounts at the rate of 40% of the margin calculated on undrawn and uncanceled commitments from the date falling 30 days after the date of the relevant Existing Revolving Credit Facility Agreement and the 2013 Guarantee Facility (as applicable) until one month prior to the final maturity date of the relevant Existing Revolving Credit Facility Agreement and the 2013 Guarantee Facility (as applicable). A guarantee fee is payable to the relevant issuing bank issuing guarantees under the 2013 Guarantee Facility in an amount equal to 0.125% of the face value of the relevant guarantee. Each guarantee issued under the 2013 Guarantee Facility carries an issuance/administration fee in the amount and at the times specified in a fee letter.

Guarantees

Each of the Existing Senior Secured Guarantors and ABO guarantees, on a senior basis, the obligations of each other obligor under the Existing Revolving Credit Facility Agreements, the 2013 Guarantee Facility Agreement and, in each case, related finance documents.

Security

The Existing Revolving Credit Facilities and the 2013 Guarantee Facility are secured by the same collateral securing, inter alia, the Existing Senior Secured Notes.

Mandatory Prepayment

For so long as an event of default has occurred and is continuing under the Existing Revolving Credit Facility Agreements, proceeds otherwise required to be applied in prepayment of the 2012 Senior Secured Notes shall instead be applied in cancellation and prepayment of the Existing Revolving Credit Facilities in priority to any other indebtedness.

Upon the occurrence of a Change of Control (as defined in each of the Existing Revolving Credit Facility Agreements and the 2013 Guarantee Facility, as applicable), the borrowers must repay the Existing Revolving Credit Facilities and the 2013 Guarantee Facility in full together with accrued interest and all other amounts accrued under related finance documents and the Existing Revolving Credit Facilities and the 2013 Guarantee Facility will be cancelled.

If an amount in excess of 50% of the 2012 Senior Secured Notes (and, in respect of the 2013 Revolving Credit Facility, an amount in excess of 50% of the 2012 Senior Secured Notes and all utilizations outstanding under and the 2013 Term Loan as at the date of the 2013 Revolving Credit Facility) is repaid, prepaid, purchased, redeemed or defeased or acquired directly or indirectly by a member of the Restricted Group, the relevant borrowers must apply an amount equal to such excess in cancellation of the Existing Revolving Credit Facilities and, if applicable, prepayment of the loans drawn thereunder.

Certain excess proceeds received by the borrowers and guarantors from certain disposals of assets and not applied or invested or committed to be applied or invested to (i) prepay, repay, purchase or redeem certain indebtedness, (ii) invest in or purchase additional assets, or (iii) make certain capital expenditure, must be applied in prepayment of the Existing Revolving Credit Facilities.

Financial Covenants, Events of Default

Each of the Existing Revolving Credit Facility Agreements and the 2013 Guarantee Facility requires the Senior Secured Notes Issuer and the Restricted Group to maintain a Consolidated Leverage Ratio (as defined in each of the Existing Revolving Credit Facility Agreements and the 2013 Guarantee Facility Agreement), of no more than 5.25:1, to be tested at the end of each fiscal quarter.

The Existing Revolving Credit Facility Agreements and the 2013 Guarantee Facility Agreement contain certain events of default the occurrence of which, subject to certain exceptions and materiality qualifications would allow the lenders party thereto to: (i) cancel the total commitments; (ii) accelerate all outstanding loans together with other accrued amounts and/or (iii) declare that all or part of the loans be repayable on demand.

Pursuant to the terms of the Intercreditor Agreement described below, the proceeds of any enforcement of collateral will be applied towards repayment of the Existing Revolving Credit Facilities, the New Super Senior Revolving Credit Facility and certain hedging obligations prior to repayment of the New Senior Secured Notes, the New Pari Passu Revolving Credit Facility, the 2012 Senior Secured Notes, the 2013 Term Loan, the 2012 Senior Note, the 2013 June Senior Notes, the 2013 Guarantee Facility and the New Term Loan.

Representations and Warranties

The Existing Revolving Credit Facility Agreements and the 2013 Guarantee Facility Agreement contain certain representations and warranties customary for facilities of this type subject to certain exceptions and customary materiality qualifications.

Undertakings

The Existing Revolving Credit Facility Agreements and the 2013 Guarantee Facility Agreement contain certain restrictive covenants which substantially reflect the covenants contained in the 2012 Senior Secured Notes and the 2013 Term Loan.

The Existing Revolving Credit Facility Agreements and the 2013 Guarantee Facility Agreement also require the Restricted Group to observe certain affirmative undertakings subject to materiality and other customary and agreed exceptions. These affirmative undertakings include, but are not limited to, undertakings related to: (i) obtaining and maintaining all necessary consents, licenses and authorizations; (ii) compliance with applicable laws; (iii) compliance with environment laws/approvals and notification of potential environmental claims; (iv) compliance with all necessary taxation requirements; (v) ensuring that any necessary authorization is not likely to be challenged, revoked, suspended or withdrawn so as to cause a material adverse effect; (vi) pari passu ranking of all payment obligations under the relevant Existing Revolving Credit Facility Agreements or the 2013 Guarantee Facility Agreement, as appropriate, and related finance documents with other unsecured unsubordinated payment obligations; (vii) the maintenance of insurance; (viii) compliance with laws and contracts relating to pension schemes and the maintenance of such pension schemes; (ix) the Facility Agent/Security Agent (as defined in the Existing Revolving Credit Facility Agreements and the 2013 Guarantee Facility Agreement, as appropriate)/accountants/other professional advisers having access to investigate reasonably suspected events of default; (x) maintenance and protection of intellectual property rights; (xi) no amendments to constitutional documents that are likely to materially adversely affect the pledges over shares or partnership interests; (xii) an entity not moving its center of main interest from, or having an establishment in any jurisdiction other than, its jurisdiction of incorporation; (xiii) restricting the business and trading activities of and assets

and liabilities held by Altice International, Cool Holding, SPV1 and the Senior Secured Notes Issuer; and (xiv) restricting the making of proceeds drawn under the Existing Revolving Credit Facility Agreements or the 2013 Guarantee Facility available to any sanctioned person or sanctioned country.

New Super Senior Revolving Credit Facility

On January 30, 2015, the Senior Secured Notes Issuer entered into a revolving facility agreement with, among others, the Senior Secured Notes Issuer, as original borrower and guarantor, certain lenders party thereto, Goldman Sachs Bank USA, J.P. Morgan Limited, Deutsche Bank AG, London Branch, Morgan Stanley Bank International Limited, Credit Suisse AG, London Branch, BNP Paribas Fortis SA/NV, Crédit Agricole Corporate and Investment Bank, Société Générale Corporate and Investment Bank, Nomura International plc, HSBC France and Citigroup Global Markets Limited as Mandated Lead Arrangers, the Borrower, Citibank International Limited as facility agent and the Security Agent as security agent, the “Facility Agreement”) as mandated lead arrangers and Citibank, N.A., London Branch as security agent (the “New Super Senior Revolving Credit Facility Agreement”). The New Super Senior Revolving Credit Facility Agreement comprises a €330 million revolving credit facility (the “New Super Senior Revolving Credit Facility”). The New Super Senior Revolving Credit Facility Agreement provides for the accession of additional borrowers and guarantors subject to the requirements set out therein. References to the “borrower”, “borrowers”, “guarantor” or “guarantors” under this section refer to the Senior Secured Notes Issuer and any additional borrowers or guarantors (as applicable) who accede to the New Super Senior Revolving Credit Facility Agreement in that capacity.

Structure of the New Super Senior Revolving Credit Facility Agreement

The final maturity date of the New Super Senior Revolving Credit Facility Agreement is the earlier of (i) the date falling five years after the date of closing in respect of the PT Portugal Acquisition and (ii) the date on which the New Super Senior Revolving Credit Facility has been fully repaid and cancelled. The borrowers are permitted to make drawdowns under the New Super Senior Revolving Credit Facility Agreement for terms of, at the relevant borrower’s election, one, two, three or six months (or any other period agreed by the Senior Secured Notes Issuer and the relevant lenders), but no such period shall end beyond the final maturity date of the New Super Senior Revolving Credit Facility Agreement. Drawdowns under the New Super Senior Revolving Credit Facility Agreement must be repaid at the end of the interest period for the relevant loan and repaid amounts may be re borrowed up to one month prior to the final maturity date (save for certain roll over loans).

Limitations on Use of Funds

The New Super Senior Revolving Credit Facility may be used by the borrowers for general corporate and working capital purposes of the Restricted Group.

The commitments under the New Super Senior Revolving Credit Facility may be increased by way of issuance of new commitment notices and compliance with the conditions set out in the New Super Senior Revolving Credit Facility Agreement. Furthermore, in connection with the PT Portugal Acquisition the proceeds of the New Super Senior Revolving Credit Facility may be deposited into an escrow account pending consummation of the PT Portugal Acquisition.

Conditions to Borrowings

Drawdowns under the New Super Senior Revolving Credit Facility Agreement are subject to certain customary conditions precedent on the date the drawdown is requested and on the drawdown date including the following: (i) no default (or, in the case of rollover loans, no event of default) continuing or occurring as a result of that drawdown; (ii) certain representations and warranties specified in the New Super Senior Revolving Credit Facility Agreement being true in all material respects and (iii) other than in respect of rollover loans, the facility agent having received certification from the Senior Secured Notes Issuer that, pro forma for the drawdown, the consolidated leverage ratio for the ratio period immediately preceding the drawdown is not greater than 5.25:1.

Interest Rates and Fees

The interest rate on each loan under the New Super Senior Revolving Credit Facility Agreement for each interest period is equal to the aggregate of (i) the margin and (ii) LIBOR, or, in relation to any loan in Euro, EURIBOR.

The margin under the New Super Senior Revolving Credit Facility Agreement is 3.50% per annum.

Interest under the New Super Senior Revolving Credit Facility Agreement accrues daily from and including the first day of an interest period and is payable on the last day of each interest period (unless the interest period is longer than six months, in which case interest is payable on the last day of each six month period) and is calculated on the basis of a

360 day year. With respect to any available but undrawn amounts under the New Super Senior Revolving Credit Facility Agreement and subject to the closing of the PT Portugal Acquisition having occurred, the borrowers are obligated to pay a commitment fee on such undrawn amounts at the rate of 40% of the margin calculated on undrawn and uncanceled commitments from the date falling 30 days after the date of the New Super Senior Revolving Credit Facility Agreement until one month prior to the final maturity date of the relevant New Super Senior Revolving Credit Facility Agreement.

Guarantees

Each of the Existing Senior Secured Guarantors and ABO guarantees, on a senior basis, the obligations of each other obligor under the New Super Senior Revolving Credit Facility Agreement and related finance documents.

Security

The New Super Senior Revolving Credit Facility is secured by the same collateral securing, *inter alia*, the Existing Senior Secured Notes.

Mandatory Prepayment

Upon the occurrence of a Change of Control or Sale (each as defined in the New Super Senior Revolving Credit Facility Agreement), subject to certain conditions each lender shall be entitled to require repayment of all amounts payable under the New Super Senior Revolving Credit Facility and related finance documents. The borrowers must repay or procure the repayment of all utilizations provided by each lender which exercises such right and the commitments of each such lender under the New Super Senior Revolving Credit Facility will be cancelled.

Subject to certain exceptions, if an amount in excess of 50% of the Senior Secured Debt (as defined in the New Super Senior Revolving Facility Agreement) is repaid, prepaid, purchased, redeemed or defeased or acquired directly or indirectly by a member of the Restricted Group, the relevant borrowers must apply a pro rata amount of such excess in cancellation of the New Super Senior Revolving Credit Facility and, if applicable, prepayment of the loans drawn thereunder.

Financial Covenants, Events of Default

The New Super Senior Revolving Credit Facility Agreement requires the Senior Secured Notes Issuer and the Restricted Group to maintain a Consolidated Net Leverage Ratio (as defined in the New Super Senior Revolving Credit Facility Agreement), of no more than 5.25:1, only to be tested at each drawdown or to the extent there are loans outstanding under the New Super Senior Revolving Credit Facility Agreement at the end of each fiscal quarter.

The New Super Senior Revolving Credit Facility Agreement contains certain events of default the occurrence of which, subject to certain exceptions and materiality qualifications would allow the lenders party thereto to: (i) cancel the total commitments; (ii) accelerate all outstanding loans together with other accrued amounts and/or (iii) declare that all or part of the loans be repayable on demand.

Pursuant to the terms of the Intercreditor Agreement described below, the proceeds of any enforcement of collateral will be applied towards repayment of the Existing Revolving Credit Facilities, the New Super Senior Revolving Credit Facility and certain hedging obligations prior to repayment of the New Senior Secured Notes, the New Pari Passu Revolving Credit Facility, the 2012 Senior Secured Notes, the 2013 Term Loan, the 2012 Senior Notes, the 2013 June Senior Notes, the 2013 Guarantee Facility and the New Term Loan.

Representations and Warranties

The New Super Senior Revolving Credit Facility Agreement contains certain representations and warranties customary for facilities of this type subject to certain exceptions and customary materiality qualifications.

Undertakings

The New Super Senior Revolving Credit Facility Agreement contains certain restrictive covenants which substantially reflect the covenants contained in the 2013 December Senior Secured Notes.

The New Super Senior Revolving Credit Facility Agreement also requires the Restricted Group to observe certain affirmative undertakings subject to materiality and other customary and agreed exceptions. These affirmative undertakings include, but are not limited to, undertakings related to: (i) obtaining and maintaining all necessary consents, licenses and authorizations; (ii) compliance with applicable laws; (iii) compliance with environment laws/approvals and

notification of potential environmental claims; (iv) compliance with all necessary taxation requirements; (v) ensuring that any necessary authorization is not likely to be challenged, revoked, suspended or withdrawn so as to cause a material adverse effect; (vi) pari passu ranking of all payment obligations under the relevant finance documents with other unsecured unsubordinated payment obligations; (vii) the maintenance of insurance; (viii) compliance with laws and contracts relating to pension schemes and the maintenance of such pension schemes; (ix) the Facility Agent/Security Agent (as defined in the New Super Senior Revolving Credit Facility Agreement)/accountants/other professional advisers having access to investigate reasonably suspected events of default; (x) maintenance and protection of intellectual property rights; (xi) no amendments to constitutional documents that are likely to materially adversely affect the pledges over shares or partnership interests; (xii) an entity not moving its centre of main interest from, or having an establishment in any jurisdiction other than, its jurisdiction of incorporation; and (xiii) restricting the making of proceeds drawn under the New Super Senior Revolving Credit Facility Agreement available to any sanctioned person or sanctioned country.

New Pari Passu Revolving Credit Facility

On December 9, 2014, the Senior Secured Notes Issuer entered into a revolving facility agreement with, among others, the Senior Secured Notes Issuer, as original borrower and guarantor, certain lenders party thereto, Morgan Stanley Bank International Limited, Deutsche Bank AG, London Branch, Goldman Sachs Bank USA, J.P. Morgan Limited, Credit Suisse AG, London Branch, BNP Paribas Fortis SA/NV, Crédit Agricole Corporate and Investment Bank, Barclays Bank plc and ING Bank France as mandated lead arrangers, Citibank International Limited as facility agent and Citibank, N.A., London Branch as security agent (as amended and restated on December 10, 2014, the “New Pari Passu Revolving Credit Facility Agreement”). The New Pari Passu Revolving Credit Facility Agreement comprises a €501 million revolving credit facility (the “New Pari Passu Revolving Credit Facility”). The New Pari Passu Revolving Credit Facility Agreement provides for the accession of additional borrowers and guarantors subject to the requirements set out therein. References to the “borrower”, “borrowers”, “guarantor” or “guarantors” under this section refer to the Senior Secured Notes Issuer and any additional borrowers or guarantors (as applicable) who accede to the New Pari Passu Revolving Credit Facility Agreement in that capacity.

Structure of the New Pari Passu Revolving Credit Facility Agreement

The final maturity date of the New Pari Passu Revolving Credit Facility Agreement is the earlier of (i) date falling five years after the original date of the New Pari Passu Revolving Credit Facility Agreement and (ii) the date on which the New Pari Passu Revolving Credit Facility has been fully repaid and cancelled. The borrowers are permitted to make drawdowns under the New Pari Passu Revolving Credit Facility Agreement for terms of, at the relevant borrower’s election, one, two, three or six months (or any other period agreed by the Senior Secured Notes Issuer and the relevant lenders), but no such period shall end beyond the final maturity date of the New Pari Passu Revolving Credit Facility Agreement. Drawdowns under the New Pari Passu Revolving Credit Facility Agreement must be repaid at the end of the interest period for the relevant loan and repaid amounts may be re borrowed up to one month prior to the final maturity date (save for certain roll over loans).

Limitations on Use of Funds

The New Pari Passu Revolving Credit Facility may be used by the borrowers for general corporate and working capital purposes of the Restricted Group, including, but not limited to (a) the refinancing of all or part of any existing financial indebtedness of the Restricted Group and (b) any financing of or payment of any costs, expenses and fees in connection with any acquisition of any person, business or undertaking of the Restricted Group.

The commitments under the New Pari Passu Revolving Credit Facility may be increased by way of issuance of new commitment notices and compliance with the conditions set out in the New Pari Passu Revolving Credit Facility Agreement.

Conditions to Borrowings

Drawdowns under the New Pari Passu Revolving Credit Facility Agreement are subject to certain customary conditions precedent on the date the drawdown is requested and on the drawdown date including the following: (i) no default (or, in the case of rollover loans, no event of default) continuing or occurring as a result of that drawdown; (ii) certain representations and warranties specified in the New Pari Passu Revolving Credit Facility Agreement being true in all material respects and (iii) other than in respect of rollover loans, the facility agent has received certification from the Senior Secured Notes Issuer that, pro forma for the drawdown, the consolidated leverage ratio for the ratio period immediately preceding the drawdown is not greater than 5.25:1.

Interest Rates and Fees

The interest rate on each loan under the New Pari Passu Revolving Credit Facility Agreement for each interest period is equal to the aggregate of (i) the margin and (ii) LIBOR, or, in relation to any loan in Euro, EURIBOR.

The margin under the New Pari Passu Revolving Credit Facility Agreement is 4.00% per annum.

Interest under the New Pari Passu Revolving Credit Facility Agreement accrues daily from and including the first day of an interest period and is payable on the last day of each interest period (unless the interest period is longer than six months, in which case interest is payable on the last day of each six month period) and is calculated on the basis of a 360 day year. With respect to any available but undrawn amounts under the New Pari Passu Revolving Credit Facility Agreement, the borrowers are obligated to pay a commitment fee on such undrawn amounts at the rate of 40% of the margin calculated on undrawn and uncanceled commitments from the date falling 30 days after the date of the New Pari Passu Revolving Credit Facility Agreement until one month prior to the final maturity date of the relevant New Pari Passu Revolving Credit Facility Agreement.

Guarantees

Each of the Existing Senior Secured Guarantors and ABO guarantees, on a senior basis, the obligations of each other obligor under the New Pari Passu Revolving Credit Facility Agreement and related finance documents.

Security

The New Pari Passu Revolving Credit Facility is secured by the same collateral securing, *inter alia*, the Existing Senior Secured Notes.

Mandatory Prepayment

Upon the occurrence of a Change of Control (as defined in the New Pari Passu Revolving Credit Facility Agreement), the borrowers must repay the New Pari Passu Revolving Credit Facility in full together with accrued interest and all other amounts accrued under related finance documents and the New Pari Passu Revolving Credit Facility will be cancelled.

Certain excess proceeds received by the borrowers and guarantors from certain disposals of assets and not applied or invested or committed to be applied or invested to (i) prepay, repay, purchase or redeem certain indebtedness, (ii) invest in or purchase additional assets, or (iii) make certain capital expenditure, must be applied in prepayment of the New Pari Passu Revolving Credit Facility Agreement.

Financial Covenants, Events of Default

The New Pari Passu Revolving Credit Facility Agreement requires the Senior Secured Notes Issuer and the Restricted Group to maintain a Consolidated Leverage Ratio, calculated on a net basis (as defined in the New Pari Passu Revolving Credit Facility Agreement) of no more than 5.25:1, only to be tested at each drawdown or to the extent there are loans or bank guarantees outstanding under the New Pari Passu Revolving Credit Facility Agreement at the end of each fiscal quarter.

The New Pari Passu Revolving Credit Facility Agreement contains certain events of default the occurrence of which, subject to certain exceptions and materiality qualifications would allow the lenders party thereto to: (i) cancel the total commitments; (ii) accelerate all outstanding loans together with other accrued amounts and/or (iii) declare that all or part of the loans be repayable on demand.

Representations and Warranties

The New Pari Passu Revolving Credit Facility Agreement contains certain representations and warranties customary for facilities of this type subject to certain exceptions and customary materiality qualifications.

Undertakings

The New Pari Passu Revolving Credit Facility Agreement contains certain restrictive covenants which substantially reflect the covenants contained in the New Senior Secured Notes.

The New Pari Passu Revolving Credit Facility Agreement also requires the Restricted Group to observe certain affirmative undertakings subject to materiality and other customary and agreed exceptions. These affirmative

undertakings include, but are not limited to, undertakings related to: (i) obtaining and maintaining all necessary consents, licenses and authorizations; (ii) compliance with applicable laws; (iii) compliance with environment laws/approvals and notification of potential environmental claims; (iv) compliance with all necessary taxation requirements; (v) ensuring that any necessary authorization is not likely to be challenged, revoked, suspended or withdrawn so as to cause a material adverse effect; (vi) pari passu ranking of all payment obligations under the relevant finance documents with other unsecured unsubordinated payment obligations; (vii) the maintenance of insurance; (viii) compliance with laws and contracts relating to pension schemes and the maintenance of such pension schemes; (ix) the Facility Agent/Security Agent (as defined in the New Pari Passu Revolving Credit Facility Agreement)/accountants/other professional advisers having access to investigate reasonably suspected events of default; (x) maintenance and protection of intellectual property rights; (xi) no amendments to constitutional documents that are likely to materially adversely affect the pledges over shares or partnership interests; (xii) an entity not moving its centre of main interest from, or having an establishment in any jurisdiction other than, its jurisdiction of incorporation; and (xiii) restricting the making of proceeds drawn under the New Pari Passu Revolving Credit Facility Agreement available to any sanctioned person or sanctioned country.

The Existing HOT Unsecured Notes

On February 27, 2011, HOT entered into a trust deed between HOT and Ziv Haft Trust Co. Ltd with respect to the unsecured notes ("Existing HOT Unsecured Notes"), which were issued on March 30, 2011 in two series: (i) in a nominal value equal to NIS 825 million or €177 million (based on the exchange rate as of September 30, 2014) pursuant to a debenture dated March 30, 2011 (the "Existing Series A HOT Notes") and (ii) in a nominal value equal to NIS 675 million or €145 million (based on the exchange rate as of September 30, 2014) pursuant to a debenture dated March 30, 2011 (the "Existing Series B HOT Notes"). The Existing Series A HOT Notes are linked to the Consumer Price Index in Israel ("CPI") and therefore actual amounts outstanding may vary from time to time and differ from the nominal amount outstanding. As of September 30, 2014, the CPI linked principal amount of Existing Series A HOT Notes outstanding was NIS 687 million or €148 million (based on the exchange rate as of September 30, 2014) and the principal amount of the Existing Series B HOT Notes outstanding was NIS 535 million or €115 million (based on the exchange rate as of September 30, 2014).

The Existing Series A HOT Notes and the Existing Series B HOT Notes mature on September 30, 2018. The amortization schedule for each of the Existing Series A HOT Notes is as follows: 8.3% in 2013; 8.3% in 2014; 8.3% in 2015; 8.3% in 2016; 8.3% in 2017 and 54.2% in 2018. Based on the CPI as of December 31, 2012 of 105.7, we estimate the amortization schedule, which includes estimated future increases in CPI of three points per year, under the Existing Series A HOT Notes is approximately: NIS 71 million in 2013, NIS 71 million in 2014, NIS 71 million in 2015, NIS 71 million in 2016, NIS 71 million in 2017 and NIS 461 million in 2018. The amortization schedule for the Existing Series B Notes is as follows approximately: NIS 56 million in 2013, NIS 56 million in 2014, NIS 56 million in 2015, NIS 56 million in 2016, NIS 56 million in 2017 and NIS 366 million in 2018. The Existing HOT Unsecured Notes are not redeemable by HOT prior to maturity.

The Existing Series A HOT Notes bear interest at a rate of 3.9% per annum, payable semi-annually. The Existing Series B HOT Notes bear interest at a rate of 6.9% per annum, payable semi-annually.

The Existing HOT Unsecured Notes contain certain financial covenants, which require maintenance by HOT of a maximum net debt to EBITDA ratio of 6.0 and maintenance of minimum equity equal to NIS 300 million. Further, in order for HOT to be able to distribute dividends, the maximum net debt to EBITDA ratio is 5.5. In addition, the Existing HOT Unsecured Notes provide that any failure to pay principal prior to expiration of any applicable grace period, or any acceleration of other HOT indebtedness of NIS 300 million or more in the aggregate, grants the holders the right to call for immediate payment of the Existing HOT Unsecured Notes.

The Existing HOT Unsecured Notes are senior obligations that rank equally with all of its existing and future senior debt and are senior to all of its existing and future subordinated debt. The Existing HOT Unsecured Notes are not secured by any assets of HOT or its subsidiaries.

The Existing HOT Unsecured Notes are not redeemable by HOT prior to maturity.

The Existing HOT Unsecured Notes will be:

- a. effectively subordinated to the HOT Refinancing Notes and the guarantees thereof granted by the HOT Refinancing Note Guarantors to the extent of the lesser of (x) the value of the assets of HOT and the HOT Refinancing Note Guarantors securing the HOT Refinancing Notes and the guarantees thereof and (y) the amount owing under the HOT Refinancing Notes;

- b. *pari passu* with the HOT Refinancing Notes to the extent the amount of the HOT Refinancing Notes exceeds the value of the assets of HOT and the HOT Refinancing Note Guarantors securing the HOT Refinancing Notes; and
- c. structurally senior to the 2012 Senior Notes, the 2012 Senior Secured Notes, the 2013 June Senior Notes, the New Notes, the New Senior Secured Notes, the 2012 Senior Secured Notes Guarantees and the 2013 June Senior Notes Guarantees granted by the 2012 Senior Secured Notes Guarantors, the 2012 Senior Notes Guarantors and the 2013 June Senior Notes Guarantors .

The Existing HOT Unsecured Notes will not be subject to the Intercreditor Agreement and, as a result, in the event of an enforcement sale of the shares of Cool Holding or HOT pursuant to the Intercreditor Agreement, the debt claims of the holders of the Existing HOT Unsecured Notes are not required to be released or otherwise transferred.

The Intercreditor Agreement

To establish the relative rights of certain of our creditors, the obligors under the 2012 Notes, the Existing Revolving Credit Facility Agreements, the New Pari Passu Revolving Credit Facility Agreement, the 2013 Guarantee Facility, the 2013 Term Loan, the New Term Loan and certain counterparties to hedging obligations relating to the foregoing, have entered into an intercreditor agreement (the “Intercreditor Agreement”) with:

- the creditors of the Revolving Credit Facilities (the “RCF Creditors”);
- any persons that accede to the Intercreditor Agreement as counterparties to certain hedging agreements in accordance with the terms of the Intercreditor Agreement (the “Hedging Agreements” and any person that accedes to the Intercreditor Agreement as counterparties to the Hedging Agreements are referred to in such capacity as the “Hedging Banks” and, together with the RCF Creditors, the “Super Priority Creditors”);
- any persons that accede to the Intercreditor Agreement under any future term facility (including the 2013 Term Loan and the New Term Loan) or revolving bank facility (including the 2013 Guarantee Facility and the New Pari Passu Revolving Credit Facility but excluding the Revolving Credit Facilities) designated a senior bank facility in accordance with the terms of the Intercreditor Agreement (the “Senior Bank Creditors”);
- any persons that accede to the Intercreditor Agreement as trustee (the “Senior Secured Notes Trustee”) for the 2012 Senior Secured Notes, the 2013 December Senior Secured Notes and the New Senior Secured Notes (and together the “Senior Secured Notes”) on its behalf and on behalf of the holders of the Senior Secured Notes (the “Senior Secured Notes Creditors” and, together with any Senior Bank Creditors, the “Senior Creditors” and, together with the Super Priority Creditors, the “Senior Secured Creditors”);
- any persons that accede to the Intercreditor Agreement as trustee for the 2012 Senior Notes, the 2013 June Senior Notes, the 2013 December Senior Notes and the New Senior Notes (and together the “Senior Subordinated Notes”) (the “Senior Subordinated Notes Trustee” on its behalf and on behalf of the holders of the Senior Subordinated Notes (the “Senior Subordinated Notes Creditors” or the “Senior Subordinated Creditors”));
- certain intra-group creditors (the “Intercompany Creditors”);
- certain members of the group who are or become structural creditors in respect of certain intra-group liabilities (the “Structural Creditors”);
- certain investors (the “Shareholders”, together with Intercompany Creditors, the “Subordinated Creditors”);
- Citibank, N.A., London Branch, as security agent for the Senior Secured Creditors (the “Security Agent”);
- Citibank International plc, as facility agent or any other administrative agent or replacement agent; and
- Citibank, N.A., London Branch as security agent for the Structural Creditors (the “Structural Creditor Security Agent”).

The Intercreditor Agreement provides that future indebtedness may be incurred by us and our subsidiaries subject to the terms of the Intercreditor Agreement and each finance document then existing. Future Super Priority Debt may, however, only be in the form of a revolving credit facility, which is a working capital facility or hedging indebtedness to the extent permitted (or not prohibited) by the terms of each finance document (including the indentures) or consented to by the appropriate parties. The aggregate commitment under all revolving credit facilities (including the 2012 Revolving Credit

Facility) that are designated as Super Priority Debt cannot exceed the greater of \$80 million or 4% of total assets at any time. The New Super Senior Revolving Credit Facility will be designated as Super Priority Debt under the Intercreditor Agreement and the creditors thereunder will thereafter be treated as RCF Creditors for purposes of the Intercreditor Agreement. The New Pari Passu Revolving Credit Facility has been designated as Senior Debt under the Intercreditor Agreement and the creditors thereunder will thereafter be treated as Senior Bank Creditors for purposes of the Intercreditor Agreement.

For the purposes of the Intercreditor Agreement, the creditors of each class of debt will vote together and a representative trustee or agent of debt within that class of debt (a "Representative") may act on the instructions of the majority of creditors of that class of debt (or, in the case of the Super Priority Debt or Senior Bank Debt (as defined below), on the instructions of 66²/₃% of creditors of that class of debt) (a "Relevant Majority"). Hedging Banks will vote together with the Super Priority Creditors while any Super Priority Debt remains outstanding. In addition, in certain circumstances (as set out in the Intercreditor Agreement) certain classes of creditors will vote together as part of an instructing group (the "Instructing Group"), which is the Relevant Majority of (i) (if Senior Bank Debt has not been incurred or, if incurred, has been discharged and while any Senior Secured Notes Debt remains outstanding) the Senior Secured Notes Creditors, (ii) (while Senior Bank Debt (as defined below) remains outstanding) the Senior Creditors, and (iii) (if the Senior Secured Debt has been discharged and while the Senior Subordinated Notes Debt remains outstanding) the Senior Subordinated Creditors.

By accepting a Senior Secured Note or a Senior Subordinated Note, as the case may be, the relevant holder thereof shall be deemed to have agreed to and accepted the terms and conditions of the Intercreditor Agreement.

The following description is a summary of certain provisions, among others, that are contained in the Intercreditor Agreement that relate to the rights and obligations of the Senior Secured Notes Creditors and the Senior Subordinated Notes Creditor. It does not restate the Intercreditor Agreement nor does it describe provisions relating to the rights and obligations of holders of other classes of our debt or capital expenditures.

Order of Priority

Ranking & Priority

The Intercreditor Agreement provides, subject to certain provisions, that the liabilities of each issuer, obligor or borrower subject to the Intercreditor Agreement (the "Obligors") (other than the Issuers of the Senior Subordinated Notes) under or in respect of the Existing Revolving Credit Facility Agreements and the New Super Senior Revolving Credit Facility Agreement (the "RCF Debt"), the Hedging Agreements (the "Hedging Debt" and, together with the RCF Debt, the "Super Priority Debt"), any Senior Bank Facilities, including the 2013 Term Loan, the New Pari Passu Revolving Credit Facility Agreement, the New Term Loan and the 2013 Guarantee Facility (the "Senior Bank Debt"), the Senior Secured Notes (the "Senior Secured Notes Debt" and, together with the Senior Bank Debt, the "Senior Debt"), the Senior Subordinated Notes (the "Senior Subordinated Notes Debt"), structural intra-group debt owed to the Structural Creditors (the "Structural Debt") and certain liabilities of members of the group owed to the Senior Notes Issuer (the "Holdco Debt") and certain other liabilities will rank in right and order of payment in the following order:

- i. *first*, the RCF Debt, the Hedging Debt, the Senior Bank Debt, the Senior Secured Notes Debt, the Structural Debt and future permitted senior or super priority debt, *pari passu* without any preference among them;
- ii. *second*, the Senior Subordinated Notes Debt and future permitted senior subordinated debt, *pari passu* without any preference among them;
- iii. *third*, the intercompany debt and the Holdco Debt, *pari passu*, without any preference among them; and
- iv. *fourth*, the shareholder debt.

To the extent any liability is owed by the Senior Notes Issuer in respect of any debt, the debt will rank in right and order of payment:

- i. *firstly*, the Senior Secured Debt (as defined below), *pari passu* without any preference among such debt; and
- ii. *secondly*, the shareholder debt.

Priority of Security

The Intercreditor Agreement provides that the Security (other than any Security created pursuant to the pledge of the shares of the Senior Notes Issuer) provided by the Obligors (and any other parties) for the Super Priority Debt, the Senior Debt (together, the “Senior Secured Debt”), the Senior Subordinated Notes Debt (together with the Senior Secured Debt, the “Secured Debt”) will rank in the following order:

- i. *firstly*, the Senior Secured Debt (*pari passu* among such class of debt); and
- ii. *secondly*, the Senior Subordinated Notes Debt.

Restrictions

Subject to certain limited exceptions and subject to, *inter alia*, the provisions set forth under the captions “—*Permitted Payments*” and “—*Restrictions on Enforcement*”, while any Senior Secured Debt is outstanding, the Intercreditor Agreement restricts:

- The ability of the Obligors and their subsidiaries to create or permit to subsist any security interest over any of their assets for any debt owed to the Senior Subordinated Creditors and the intercompany creditors and shareholders (the “Subordinated Debt”);
- the ability of the Obligors and their subsidiaries to pay, purchase, redeem or acquire any of the Senior Subordinated Notes Debt or the Holdco Debt, or otherwise to provide financial support in relation to such liabilities, except in respect of any Senior Subordinated Notes Debt in connection with any such payment or acquisition of any Senior Subordinated Notes Debt by the Issuers in respect of the Senior Subordinated Debt (the “Senior Subordinated Notes Issuer”); and
- the ability of the Senior Subordinated Creditors to enforce the Senior Subordinated Notes Debt or the Holdco Debt and the security relating thereto, to demand or receive payments toward the discharge of any Senior Subordinated Notes Debt, any Holdco Debt or to apply money or property toward the discharge of any Senior Subordinated Notes Debt or any Holdco Debt,

in each case, unless consented to by the applicable Super Priority Creditors and whilst any Senior Debt is outstanding to the extent prohibited by the Senior Designated Debt Documents, the applicable Senior Creditors.

In addition, the Intercreditor Agreement provides that the Security and guarantees relating to the Senior Secured Debt (and the Senior Subordinated Notes Debt) will be released in certain circumstances. See “—*Release of Security and Guarantees*”. Moreover, certain proceeds received by the Senior Secured Creditors and the Senior Subordinated Creditors or the Subordinated Creditors (other than in connection with the Senior Subordinated Notes Debt of the Senior Subordinated Notes Issuer) must be turned over to the Security Agent pursuant to the Intercreditor Agreement for application in accordance with the Intercreditor Agreement. See “—*Turnover*”.

The Intercreditor Agreement provides for certain additional restrictions on the form, provisions and terms of the documents evidencing the Structural Debt. No Structural Creditor and no member of the Group will be entitled to make material amendments to the documents evidencing the Structural Debt without the prior written consent of the relevant Representative representing the Super Priority Creditors, the Senior Bank Creditors and the Senior Secured Notes Creditors.

Limitation of Credit Support

Pursuant to the Intercreditor Agreement, the Obligors are prohibited from granting any security in favor of any Senior Secured Debt unless that security is given in favor of the Security Agent to hold for the benefit of all other Senior Secured Debt.

Permitted Payments

The Intercreditor Agreement permits Obligors to pay, *inter alia*:

1. while any Senior Secured Debt is outstanding, any amounts then due under the Senior Subordinated Notes Debt if:

- a. the payment is a Permitted Payment (as defined below) (or in lieu thereof, a payment of an amount to the issuer of Senior Subordinated Notes to enable it to make a corresponding Permitted Payment) or is not prohibited under the terms of any documents governing the Senior Secured Debt;
 - b. on the date falling two days prior to the date of payment, no payment default is outstanding (or has been accelerated/placed on demand); and
 - c. no Stop Notice (as defined below) is outstanding; or
 - d. with the consent of each of:
 - i. (while any of the Super Priority Debt is outstanding) the Representative representing the Relevant Majority of the Super Priority Creditors;
 - ii. (while any Senior Bank Debt is outstanding) the Representative representing the Relevant Majority of (A) the Senior Bank Creditors and (B) (only to the extent prohibited by the Senior Secured Notes Indenture) the Senior Secured Notes Creditors; and
 - iii. (if any Senior Bank Debt has been discharged and while the Senior Secured Notes Debt is outstanding) (only to the extent prohibited under the Senior Secured Notes Indentures) the Representative representing Relevant Majority of the Senior Secured Notes Creditors;
2. while any Senior Subordinated Debt is outstanding, any amounts under the intercompany debt and the shareholder debt if:
- a. except in relation to an intercompany debt to an Obligor, the amount is due and payable under the terms of the intercompany debt documents;
 - b. the payment is not prohibited under the terms of any documents governing the Senior Secured Debt and/or the Senior Subordinated Notes Debt; and
 - c. in relation to an intercompany debt to a non-Obligor and any shareholder debt, no enforcement trigger event is outstanding; or
 - d. with the consent of each of:
 - i. (while any Super Priority Debt is outstanding) the Representative representing the Relevant Majority of the Super Priority Debt;
 - ii. (while any Senior Bank Debt is outstanding) the Representative representing the Relevant Majority of (A) the Senior Bank Creditors and (B) (only to the extent prohibited by the Senior Secured Notes Indentures), the Senior Secured Notes Creditors;
 - iii. (if any Senior Bank Debt has been discharged but while any Senior Secured Notes Debt is outstanding and only to the extent prohibited under the Senior Secured Notes Indenture (to the extent prohibited by a Senior Secured Notes Designated Debt Document (as defined below)) the Representative representing the Relevant Majority of the Senior Secured Notes Creditors; and
 - iv. (while any Senior Subordinated Debt is outstanding), the Representative representing the Relevant Majority of Senior Subordinated Creditors; and
3. while any Senior Secured Debt is outstanding, the Obligors will only be permitted to make payments of Holdco Debt
- a. with the prior written consent of:
 - i. (while any Super Priority Debt is outstanding) the relevant Representatives representing the Relevant Majority of the Super Priority Creditors;

- ii. (while any Senior Bank Debt is outstanding) the Representatives representing the Relevant Majority of (x) the Senior Bank Creditors and (y) (only to the extent prohibited by the Senior Secured Notes Indenture) the relevant Representatives Senior Secured Notes Creditors; and
 - iii. (if any Senior Bank Debt has been discharged and while the Senior Secured Notes Debt is outstanding) (only to the extent prohibited by the Senior Secured Notes Indenture) the relevant Representatives representing the Relevant Majority of the Senior Secured Notes Creditors; or
- b. such payments are equal to the amount of payments in respect of the liabilities owed to the Senior Subordinated Notes Creditors.

A Representative representing i) the relevant Senior Bank Lenders or ii) the relevant Senior Secured Notes Creditors or iii) the relevant Super Priority Creditors (each in accordance with its underlying documents) may serve a notice specifying that an event of default is outstanding and suspend the payment of any Senior Subordinated Notes Debt (a “Stop Notice”) until the earlier of: (i) 179 days after the Stop Notice, (ii) if an enforcement notice specifying a default under the Senior Subordinated Notes Debt has been served by a Representative of the Relevant Majority of the Senior Subordinated Creditors (an “Enforcement Notice”) and a standstill period of 179 days (a “Standstill Period”) is already in effect, the date on which the aforementioned Standstill Period expires, (iii) the date on which the event of default under the relevant Super Priority Debt document or Senior Debt document has been remedied or waived in accordance with the relevant debt document, (iv) the date on which each Representative that served the Stop Notice cancels such Stop Notice, (v) the date on which the creditors with respect to the Senior Subordinated Debt take enforcement action in accordance with (and as permitted by) the Intercreditor Agreement, and (vi) the date the Senior Secured Debt is no longer outstanding. The Stop Notice is to be issued within 45 days of receipt of notice of such default and only one such notice may be served within any 360 day period and not more than one Stop Notice may be served in respect of the same event or set of circumstances. Notwithstanding the foregoing, the Senior Secured Notes Trustee will be entitled to receive and retain certain amounts payable for its own account. A Stop Notice shall be deemed to be in effect if a payment default is outstanding in respect of any Senior Secured Debt.

For purposes of the Intercreditor Agreement, “Permitted Payments” is defined to include certain customary permitted payments which include scheduled payments of interest; amounts payable under Senior Subordinated Notes by way of default interest, liquidated charges or penalty interest; amounts payable under applicable gross up provisions or currency indemnities; fees, costs, expenses and taxes incurred in respect of the issuance and offering of the Senior Subordinated Notes or the ordinary day-to-day administration of the Senior Notes; principal amount of the Senior Subordinated Notes upon or after their originally scheduled maturity; any other amount not exceeding an agreed amount in any 12-month period; note trustee costs and security agent costs; certain permitted defeasance trust payments; amounts funded from the proceeds of issuance of, or exchanged for or converted into certain defined permitted junior securities any other amounts consented to by the Representatives representing the Relevant Majority of each of the Super Priority Debt and Senior Debt.

Restrictions on Enforcement

Subject to certain limited exceptions, and except with the consent of the Relevant Majority of Super Priority Creditors (while the Super Priority Debt is outstanding) and the Instructing Group, while Senior Secured Debt is outstanding, the Senior Subordinated Creditors cannot (i) demand payment of any Senior Subordinated Notes Debt or Subordinated Debt, (ii) accelerate any of the Senior Subordinated Notes Debt or the Subordinated Debt or otherwise declare any of the aforementioned debt prematurely due or payable on an event of default or otherwise, (iii) enforce any of the Senior Subordinated Notes Debt or Subordinated Debt by attachment, set-off, execution or otherwise, (iv) (in the case of Senior Subordinated Creditors) enforce the Security relating to the Senior Subordinated Notes Debt, (v) petition for, initiate, support or take any steps with a view to any insolvency or any voluntary arrangement or assignment for the benefit of creditors or any similar proceedings involving an Obligor, (vi) sue or bring or support any legal proceedings against any Obligor or its subsidiaries or (vii) otherwise exercise any remedy for the recovery of any Senior Subordinated Notes Debt or Subordinated Debt. The aforementioned does not prohibit the Senior Subordinated Creditors from, among others, (i) taking any necessary action to preserve the validity and existence of any claims, (ii) taking any action against any creditor to challenge the basis on which any sale or disposal is to take place pursuant to powers granted under any security documents, (iii) bringing proceedings in relation to violations of securities laws/regulations or for fraud, (iv) solely for injunctive relief to restrain any actual or punitive breach of the indenture governing the Senior Subordinated Notes or for specific performance not claiming damages not inconsistent with the Intercreditor Agreement, (v) against the Senior Subordinated Notes Issuer, or (vi) requesting judicial interpretation of any provision of any Senior Subordinated Creditor finance document. A Senior Subordinated Creditor or Subordinated Creditor will be allowed to bring or support proceedings to prevent the loss of any right to bring or support proceeding by reason of expiry of statutory limitation periods. Subject to the written instructions of the Security Agent (acting on the instructions of the relevant Creditors entitled to take enforcement action with respect to the Collateral) no Structural Creditor may, while any Senior Secured Debt is outstanding take certain actions in respect of the Structural Debt including (i) accelerate any

of the Structural Debt or otherwise declare any of the Structural Debt prematurely due or payable as a result of a default or an event of default (howsoever described), (ii) enforce any of the Structural Debt by attachment, set-off, execution or otherwise, (iii) enforce (or give instructions to the Structural Creditor Security Agent to enforce) the security securing the Structural Debt, (iv) petition (or vote in favor of any resolution in favor for) or initiate or take any steps with a view to any insolvency or any voluntary agreement or assignment for the benefit of creditors or any similar proceedings involving HOT and/or its direct or indirect subsidiaries, (v) sue or bring or support any legal proceedings against HOT and/or any of its direct or indirect Subsidiaries, or (vi) otherwise exercise any remedy for the recovery of any Structural Debt.

In addition to customary termination rights under the Hedging Agreements, the Hedging Banks benefit from certain additional termination rights permitting termination or close-out of the relevant Hedging Agreement prior to its stated maturity in the following circumstances (in each case subject to a grace period of at least 30 days from the date of occurrence of the relevant circumstance, and subject in each individual circumstance to the applicable grace periods set out in the relevant finance document):

- (a) a payment default under any financial indebtedness (subject to any applicable grace period) of the Senior Notes Issuer, any Covenant Party or their subsidiaries in excess of \$20 million has occurred;
- (b) a default (other than a payment default) and subsequent acceleration of any amounts of financial indebtedness equal to or greater than \$20 million;
- (c) failure by the Senior Secured Notes Issuer, an Obligor or a Significant Subsidiary (as defined in Senior Secured Notes Indentures) to pay final judgments aggregating in excess of \$20 million (exclusive of any amounts that a solvent insurance company has acknowledged liability for), which judgments are not paid, discharged or stayed for a period of 60 days after the judgment becomes final;
- (d) any impairment of security and/or guarantees which constitutes an event of default under the Senior Secured Notes Indentures;
- (e) any event of default or prepayment event under the Senior Secured Notes Indentures or any other relevant finance document caused by a change of control; or
- (f) any event of default or prepayment event under the Senior Secured Notes Indentures or any other relevant finance document which is caused as a result of: (i) a cross-default, (ii) a breach of the covenant relating to indebtedness, (iii) a breach of the covenant relating to restricted payments, (iv) a breach of the covenant relating to certain distributions, (v) a breach of the covenant relating to asset sales and subsidiary stock, (vi) a breach of the covenant relating to issuer activities, (vii) a breach of the covenant relating to holding company activities, (viii) a breach of the covenant relating to impairment of security and (ix) a breach of the covenant relating to affiliate transactions.

Permitted Enforcement

Despite the restrictions of enforcement described above, the Intercreditor Agreement allows the Senior Subordinated Creditors to take the aforementioned enforcement actions while any Senior Secured Debt is outstanding if (i) payment of the Senior Secured Debt has been accelerated or declared prematurely due and payable or payable on demand or the Relevant Majority of Super Priority Creditors and/or Senior Creditors have taken any enforcement action under the security documents in relation to such debt, (ii) certain insolvency, liquidation or other similar enforcement events have occurred with respect to an Obligor (other than an Obligor that is not a borrower or guarantor under any Senior Secured Debt) and such actions are taken with respect to such Obligor, (iii) there is an event of default under the Senior Subordinated Notes Debt for failure to pay principal at its originally scheduled maturity, (iv) the proposed enforcement action has been consented to by the Relevant Majority of Super Priority Debt, Senior Bank Creditors, Senior Secured Notes Creditors or (v) a period (the "Standstill Period") of not less than 179 days has elapsed from the date any Representative of the Senior Secured Creditors received an Enforcement Notice from the Senior Subordinated Creditors relating to an event of default under the applicable documents relating to such Senior Subordinated Debt and such event of default is outstanding at (and has not been waived prior to) the end of the Standstill Period.

The Intercreditor Agreement will require the Security Agent to give prompt notice to the representative of the Senior Subordinated Notes Debt if it is instructed to enforce the security relating to the equity/ownership interest securing Senior Secured Debt (a "Senior Enforcement"). During the period from the giving of that notice to the date that the Security Agent ceases to use all reasonable commercial efforts to carry out that Senior Enforcement as expeditiously as reasonably practicable having regard to the circumstances:

- the Security Agent will not be permitted to enforce any Security over such equity interests in a manner that would adversely affect such Senior Enforcement; and
- no Senior Subordinated Creditor will be permitted to take, or will be permitted to give any instructions to the Security Agent to take, any enforcement action prohibited by the preceding bullet,

provided that the foregoing will not prejudice any other rights of the Senior Subordinated Creditors to take any enforcement action against any other Obligor that are permitted under the Intercreditor Agreement. The Intercreditor Agreement will require the Security Agent to give prompt notice to the Representative of Senior Subordinated Notes Debt of its ceasing to carry out a Senior Enforcement.

Enforcement Instructions

No Senior Secured Creditor or Senior Subordinated Notes Creditor has any independent power to enforce, or have recourse to, any Security except through the Security Agent and the Security Agent shall enforce Security (if then enforceable) if so instructed by (i) while the Super Priority Debt is outstanding, the Relevant Majority of Super Priority Creditors or the Instructing Group, and (ii) after the discharge of the Senior Secured Debt (or if permitted to do so as described above under “—*Limitations on Enforcement*”), the Relevant Majority of Senior Subordinated Creditors. The Security Agent may disregard any instructions from any other person to enforce the Security and may disregard any instructions to enforce any Security if those instructions are inconsistent with the Intercreditor Agreement. The Security Agent is not obliged to enforce the Security if it is not appropriately indemnified by the relevant creditors.

No Structural Creditor has any independent power to enforce, or have recourse to, any security serving the Structural Debt.

To the extent any Super Priority Creditors or the Instructing Group wish to accelerate any debt owing to any Senior Secured Creditor, it must notify the Security Agent and each other Senior Secured Representative at least three business days prior to the date it intends to accelerate. To the extent that the Super Priority Creditors or the Instructing Group wish to enforce Security, they must notify the Security Agent and each other Senior Secured Representative 10 business days prior to the date it issues the enforcement instructions (the “Proposed Enforcement Instruction Date”). If the Security Agent receives conflicting enforcement instructions prior to the Proposed Enforcement Instruction Date, the Representatives of the Super Priority Creditors and the Representative of the Instructing Group shall consult with one another and with the Security Agent in good faith for 30 days (or such shorter date as may be agreed) (the “Consultation Period”). Consultation will not be required if the Security has become enforceable as a result of an insolvency event relating to an Obligor against whom such enforcement action is taken or if any of such instructing representatives determines in good faith that consultation (and thereby the delay) could reasonably be expected to have a material adverse effect on the ability to enforce the Security or the realization of proceeds of enforcement.

While the Super Priority Debt is outstanding, if the Security Agent receives conflicting enforcement instructions from the Representatives of the Super Priority Debt or the Instructing Group, and the 30 day consultation period between the two parties has passed, the Security Agent shall comply with the instruction from the Instructing Group. The failure by a creditor group to issue enforcement instructions will be deemed to be conflicting, provided that if the representatives of the Instructing Group fail to give instructions as to enforcement and the 30 day consultation period has elapsed without the Instructing Group issuing instructions, the Security Agent will comply with the instructions of the representative of the Super Priority Debt. The instructions of the Super Priority Creditors will prevail if i) the Super Priority Creditors have not been fully and finally discharged in cash within six months of the Proposed Enforcement Date, or ii) the Security Agent has not commenced any enforcement action within 3 months of the Proposed Enforcement Date. All enforcement instructions will need to comply with the following security enforcement principles:

1. It shall be the aim of any enforcement of the Security to achieve the Security Enforcement Objective (hereinafter defined). “Security Enforcement Objective” means maximizing, so far as is consistent with a prompt and expeditious enforcement of the Security, the recovery of the Super Priority Creditors and (without prejudice to the waterfall described in “*Application of Proceeds*” below) the Senior Creditors.
2. The security enforcement principles may be amended, varied or waived with the prior written consent of the Relevant Majority of Super Priority Creditors, an Instructing Group and the Security Agent.
3. Without prejudice to the Security Enforcement Objective, the Security will be enforced and other action as to enforcement of the Security will be taken such that either:
 - (a) in the event enforcement is being effected in accordance with the instructions of the Instructing Group either:

- (i) all proceeds of enforcement are received by the Security Agent in cash for distribution in accordance with the waterfall described in “*Application of Proceeds*” below; or
 - (ii) sufficient proceeds from enforcement will be received by the Security Agent in cash to ensure that when the proceeds are applied in accordance with the waterfall described in “*Application of Proceeds*” below), the Super Priority Debt is repaid and discharged in full (unless the Relevant Majority of Super Priority Creditors agree otherwise); or
 - (b) in the event enforcement is being effected in accordance with the instructions of the Super Priority Creditors either:
 - (i) all proceeds of enforcement are received by the Security Agent in cash for distribution in accordance with the waterfall described in “*Application of Proceeds*” below; or
 - (ii) with the consent of the Instructing Group, the proceeds are received by the Security Agent in cash and non-cash consideration for distribution in accordance with the waterfall described in “*Application of Proceeds*” below.
4. The enforcement must be prompt and expeditious it being acknowledged that, subject to the other provisions of the Intercreditor Agreement, the time frame for realization of value from the enforcement of the Security pursuant to enforcement will be determined by (while any Super Priority Debt is outstanding) the Representatives representing the Relevant Majority of Super Priority Creditors or the relevant Representatives representing an Instructing Group provided that it is consistent with the Security Enforcement Objective.
5. On:
- (a) a proposed enforcement of any of the Security over assets other than shares in a member of the Group, where the aggregate book value of such assets exceeds U.S.\$ 3,000,000 (or its equivalent); or
 - (b) a proposed enforcement of any of the Security over some, but not all, of the shares in a member of the Holdco Group (being any Covenant Party and the Senior Notes Issuer and their respective Subsidiaries from time to time) over which Security exists.
- the Security Agent shall, if so requested by (while the Super Priority Debt is outstanding) the Representatives representing the Relevant Majority of Super Priority Creditors or the relevant Representatives representing an Instructing Group, and at the expense of such creditors, obtain an opinion from any (X) “big four” accounting firm, (Y) reputable and independent internationally recognized investment bank, or (Z) other reputable and independent professional services firm experience in restructuring and enforcement (a “Financial Advisor”), that the consideration for the sale is fair from a financial point of view after taking into account all relevant circumstances. If the Security Agent is unable to obtain an opinion pursuant to this paragraph 5, it shall notify the Super Priority Representatives and the Senior Representatives representing an Instructing Group and may proceed to enforce the Security without obtaining such opinion.
6. The Security Agent shall be under no obligation to appoint a Financial Advisor or to seek the advice of a Financial Advisor, unless expressly required to do so by the security enforcement principles or any other provision of the Intercreditor Agreement.
7. The Financial Advisor’s opinion will be conclusive evidence that the Security Enforcement Objective has been met.
8. If enforcement of any Security is conducted by way of public auction in any relevant jurisdiction, no Financial Advisor shall be required to be appointed in relation to such enforcement action. Nothing shall require the enforcement of Security to take place by way of public auction.

Release of Security and Guarantees

An Obligor may dispose of an asset outside of the Holdco Group if (i) the disposal is not prohibited by the underlying finance documents, or (ii) the disposal is being effected at the request of the relevant creditor in circumstances where it is entitled to take enforcement action under the Intercreditor Agreement (and such disposal is consistent with certain security enforcement principles), or (iii) the disposal is pursuant to enforcement action in accordance with the

Intercreditor Agreement, and, in each case, the Security Agent is authorized to release any Security or any security securing the Structural Debt and other claims (including guarantees) under any finance document over that asset and, if that asset comprises of the shares in the capital of an Obligor or any of its subsidiaries which are subject to Security or any security securing the Structural Debt, release on behalf of the relevant creditor and each Obligor and its Subsidiaries that subsidiary and its subsidiaries from all present and future obligations and liabilities under the relevant finance document provided that the proceeds of the disposal is applied in accordance with the relevant finance document and with the Intercreditor Agreement.

Where a disposal relates to (ii) or (iii) above, the Security Agent is only authorized to release the relevant Security and liabilities owing to the Senior Subordinated Creditors if (i) the proceeds are received by the Security Agent in cash (or substantially all cash); (ii) the disposal is made pursuant to a public auction or with an opinion from a restructuring advisor confirming that the disposal price is fair (taking into account all relevant circumstances); (iii) the debt is simultaneously and unconditionally released (and not assumed by a purchaser or affiliate of a purchaser) and (iv) the proceeds are applied in accordance with the Intercreditor Agreement.

Where liabilities in respect of any Senior Secured Debt would otherwise be released, the relevant creditor may elect to transfer such liabilities to the Senior Notes Issuer or the original Shareholder. If shares in an Obligor or its holding company are being disposed of and the Security Agent decides to dispose of all or part of the liabilities of such Obligor, holding company or any subsidiary under the finance documents, the Security Agent may: (a) dispose of all or part of such liabilities such that the transferee shall not be treated as a Senior Secured Creditor or a secured party; and (b) dispose of all (and not part) of such liabilities owed to the Senior Secured Creditors on behalf of the relevant creditors and Obligors such that the transferee be treated as a Senior Secured Creditor or a secured party.

Turnover

The Intercreditor Agreement also provides that if any Super Priority Creditor, Senior Secured Creditor (with respect to proceeds from the enforcement of security and proceeds of certain disposals only), Structural Creditor (with respect to proceeds from the enforcement of security securing the Structural Debt only), Senior Subordinated Creditor or Subordinated Creditor receives or recovers a payment of any Senior Secured Debt, Structural Debt, Senior Subordinated Notes Debt or Subordinated Debt which is prohibited by the Intercreditor Agreement or not paid in accordance with the provisions described under “—*Application of Proceeds*”, subject to certain exceptions, the receiving or recovering creditor will promptly notify the Security Agent and hold any amount on trust for the creditors and, upon demand by the Security Agent, pay that amount to the Security Agent or, if lower, the amount of debt owed to the relevant category of creditor, in each case less the third party costs and expenses (if any) reasonably incurred in receiving or recovering such amount, for application by the Security Agent in accordance with the order of priority described under “—*Application of Proceeds*”. These provisions will not apply to any receipt or recovery by the Hedging Banks in relation to certain netting and set-off arrangements with Obligors, permitted refinancing or the loss sharing provisions of the Intercreditor Agreement.

Subordination on Insolvency

After the occurrence of an insolvency event in relation to any Obligor (the “Insolvent Obligor”), the Senior Subordinated Debt owed by the Insolvent Obligor will be subordinated in right of payment to the Super Priority Debt and Senior Debt owed by such Insolvent Obligor. Moreover, the shareholder debt and (unless otherwise required by (while the Super Priority Debt remains outstanding) the Relevant Majority of Super Priority Creditors or the Instructing Group) the Intercompany Debt owed by the Insolvent Obligor will be subordinate in right of payment to the Secured Debt owed by such Insolvent Obligor.

Filing of Claims

While any Senior Secured Debt is outstanding, the Security Agent is authorized (acting on the instructions of (while any Super Priority Debt excluding Hedging Debt is outstanding) the Relevant Majority of Super Priority Creditors or the Instructing Group) to: (i) claim, enforce and prove for any debt owed by the Insolvent Obligor (ii) only with respect to shareholder debt, exercise all powers of convening meetings, voting and representations in respect of the shareholder debt owed by the Insolvent Obligor (iii) file claims and proofs, give receipts and take all such proceedings and do all such things as the Security Agent considers reasonably necessary to recover any debt owed by the Insolvent Obligor and (iv) receive all payments of or in respect of any debt owed by the Insolvent Obligor for application in accordance with the provisions set forth under “—*Application of Proceeds*.” Notwithstanding the foregoing, nothing shall (i) entitle any party to exercise or require any other party to exercise such power of voting or representation to waive, reduce, discharge, extend the due date for payment of or reschedule any of the Senior Subordinated Debt; or (ii) be deemed to require any Senior Subordinated Notes Creditor to hold a meeting or pass any resolution at such meeting or give any consent pursuant to the terms of any finance documents, or (iii) authorize any Super Priority Creditor or Senior Secured Creditor to take any action against the Senior Subordinated Notes Issuer in respect of the Senior Subordinated Debt.

If the Security Agent is not entitled or does not take any of the actions referred to above the representative of Senior Subordinated Debt, the Senior Subordinated Notes Creditor and the Subordinated Creditors (i) will each do so promptly when requested by the Security Agent (acting on the instructions of (while Super Priority Debt is outstanding) the Relevant Majority of Super Priority Creditors or the Instructing Group subject, in the case of Senior Subordinated Creditors only, to either or both the Super Priority Creditors or the Senior Creditors giving an appropriate indemnity for any costs and expenses which may be reasonably incurred by the Senior Subordinated Creditors and their representative in doing or taking the actions so requested); and (ii) may each do so to the extent permitted as described under “—Restrictions on Enforcement.”

Application of Proceeds

Subject to the rights of any creditor (other than a Secured Creditor or a Structural Creditor) with prior security or preferential claims, (i) all amounts from time to time received pursuant to the provisions described under “—Turnover” or otherwise recovered by the Security Agent (or any other creditors) in connection with the realization or enforcement of all or any part of the security in favor of the Senior Secured Debt or Senior Subordinated Notes Debt (other than the pledge of the shares of the Senior Notes Issuer), the sale of any asset of any Obligor pursuant to an insolvency event or, an enforcement action, judicial supervised or sanctioned reorganization or administrative work-out restructuring or otherwise and (ii) all amounts from time to time received or recovered by the Structural Creditor Security Agent in connection with the realization or enforcement of the security securing the Structural Debt, shall be held by the Security Agent or the Structural Security Agent, on trust, in each case to apply them at any time as the Security Agent or the Structural Creditor Security Agent sees fit in the following order:

- first, in payment of the following amounts in the following order of priority: (i) *pari passu* and pro rata to the Security Agent and the Structural Creditor Security Agent and thereafter to the trustees to the Senior Subordinated Notes and Senior Secured Notes of any amounts due to each such party, and (ii) *pari passu* and pro rata to each representative of Super Priority Debt, Senior Bank Debt, Senior Secured Notes Debt and Senior Subordinated Notes Debt of the fees, costs, expenses and liabilities (and all interest thereon as provided in the relevant finance documents) of each such representative and any receiver, attorney or agent appointed by such representative under the security documents, the Structural Debt Documents or the Intercreditor Agreement;
- second, in payment *pari passu* and pro rata of the balance of the costs and expenses of each Super Priority Creditor in connection with such enforcement;
- third, in payment *pari passu* and pro rata to the representative of the Super Priority Debt and the Hedging Banks for application towards the balance of the Super Priority Debt;
- fourth, in payment of the balance of the costs and expenses of each Senior Creditor in connection with such enforcement;
- fifth, in payment *pari passu* and pro rata to each representative of Senior Debt for application towards (i) Senior Bank Debt and (ii) Senior Secured Notes Debt;
- sixth, (only to the extent secured) in payment of the balance of the costs and expenses of each Senior Subordinated Creditor in connection with such enforcement;
- seventh, (only to the extent secured) in payment *pari passu* and pro rata to each Senior Subordinated Creditor towards the balance of the Senior Subordinated Notes Debt;

eighth, in payment of the surplus (if any) to the Obligors or other person entitled to it.

Subject to the rights of any creditor (other than a Secured Creditor) with prior security or preferential claims, all amounts from time to time received or recovered by the Security Agent in connection with the realization or enforcement of Security created pursuant to the pledge of the shares of the Senior Notes Issuer shall be held by the Security Agent on trust to apply them at any time as the Security Agent (in its discretion) sees fit in the following order:

- first, in payment of the following amounts in the following order of priority: (i) to the Security Agent and trustee to the Notes and of any amounts due to each such party, and (ii) *pari passu* and pro rata to each representative of Senior Subordinated Notes Debt and of such other senior subordinated debt of the fees, costs, expenses and liabilities (and all interest thereon as provided in the relevant finance documents) of each such representative and any receiver, attorney or agent appointed by such representative under the security documents or the Intercreditor Agreement;
- second, in payment *pari passu* and pro rata of the balance of the costs and expenses of each Senior Subordinated Creditor and such other senior subordinated debt creditor in connection with such enforcement;

- third, in payment *pari passu* and pro rata to the representative of the Senior Subordinated Notes Debt and of such other senior subordinated debt for application towards the balance of the Senior Subordinated Notes Debt;
- fourth, in payment of the surplus (if any) to the Obligor or other person entitled to it.

Amendment

Prior consent of each Representative (other than any Senior Subordinated Representative unless in respect of an amendment, waiver or consent under any security document evidencing Security in favor of the Senior Subordinated Creditors) is required for any waivers, consents, or amendments in relation to any security documents (including any Structural Debt Security document) if any such amendments, waivers or consents would adversely affect the nature or scope of the charged property or the nature or scope of the assets which are or expressed to be the subject of security for the Structural Debt (the “Structural Debt Security”) or the manner in which the proceeds of enforcement of Security or the Structural Debt Security is distributed.

Any Senior Subordinated Notes documents may be amended in accordance with their terms i) if permitted by the Senior Secured Debt documents or with the consent of (while Super Priority Debt excluding Hedging Debt is outstanding) the representatives representing the Super Priority Creditors, the Senior Bank Creditors and (but only to the extent prohibited by the indentures governing the Senior Secured Notes) the Senior Secured Note Creditors or ii) in certain other limited circumstances.

The Intercreditor Agreement may be amended by the Obligor and the Security Agent without consent of the other parties if the amendment is to cure defects, typographical errors, resolve ambiguities or reflect changes, in each case, of a minor technical or administrative nature. Where an amendment affects the rights and obligations of one or more parties to the Intercreditor Agreement, and could not reasonably be expected to be adverse to the interests of other parties or class of parties, only the parties affected by such amendment need to agree to the amendments.

Other than in respect of certain customary amendments and waivers (which require the consent of each of the Senior Secured Creditors, the Senior Subordinated Creditors, the Super Priority Creditors, the Security Agent and the Issuers), the Intercreditor Agreement may be amended or waived or any consent may be given under it with the written agreement of the Majority Super Priority Creditors, the Majority Senior Bank Creditors, the Majority Senior Secured Notes Creditors and the Majority Senior Subordinated Creditors, the Issuers, the Security Agent and the Structural Creditor Security Agent.

License Guarantees

HOT and its subsidiaries are required to provide guarantees, often by way of a bank guarantee, to the Ministry of Communications and Broadcast Council in connection with various operating and broadcasting licenses, including providing a bank guarantee in the amount of NIS 695 million in connection with the HOT Mobile’s winning a frequency allotment and receiving a mobile license in 2011. As of the first testing date on September 26, 2013, we have achieved a market share calculated in accordance with the license agreement that would entitle us to a deduction of the entire amount of the NIS 695 million license fee outstanding. Accordingly, we requested the Israeli Ministry of Communications to reduce the amount of the bank guarantee to an amount of NIS 80 million as guarantee of our obligation to achieve certain territorial coverage requirements under our license. On November 21, 2013, the Israeli Ministry of Communications notified HOT Mobile that the license fees shall be decreased to NIS 10 million (which has already been paid) and the bank guarantee shall be decreased from the amount of NIS 695 to an amount of NIS 80 million. For more information “*Description of Our Business—Material Agreements—Provision of certain bank guarantees to the State of Israel relating to performance of certain license terms*”.

HOT Mobile Earnout

In connection with the acquisition by HOT of HOT Mobile from Altice Securities S.à r.l. (“Altice Securities”), a subsidiary of Altice and affiliate of HOT, HOT agreed to pay to the managers of HOT Mobile and an unrelated third party (“Migad”, and, together with the managers of HOT Mobile and Altice Securities, the “Earnout Recipients”) additional consideration, in an amount of NIS 450 million, which is subject to future performance targets with respect to HOT Mobile (the “Earnout”). The Earnout includes (i) a contingent future payment of NIS 225 million, paid in four equal installments of NIS 56.25 million, conditioned upon achievement of certain EBITDA targets by HOT Mobile for the years 2013 to 2016, inclusive, and (ii) a contingent future payment of NIS 225 million conditioned on achievement of 7% market share, as defined in the HOT Mobile’s mobile license, in the mobile market by 2016. There is a mechanism to reduce the payments required under the Earnout to the extent HOT Mobile is required to make payments to the Israeli Ministry of Communications pursuant to the mobile license. As of September 30, 2014, we estimate that the fair value of the Earnout is NIS 75 million and Altice Securities has pro rata rights to approximately 94% of the Earnout. Altice Securities has transferred its rights and entitlements to payments under the Earnout to the Senior Notes Issuer (the

assigned rights only include such payments that would actually have been received by Altice Securities). In June 2013, HOT paid NIS 90 million under the Earnout to the Earnout Recipients in accordance with the terms of the Earnout, out of which the Senior Notes Issuer received NIS 86.4 million. Furthermore, in the months of August and September 2013, HOT transferred amounts of NIS 4.5 million and NIS 1.5 million to Migad Communications Ltd. and to the other parties, respectively on behalf their share of the above consideration. See “*Certain Relationships and Related Party Transactions—HOT Mobile Earnout*”.

HOT Refinancing Note

The following contains a summary of the terms of the HOT Proceeds Term Note and the HOT Refinancing RCF Note. It does not purport to be complete and is subject to, and qualified in its entirety by reference to, the underlying documents.

HOT Proceeds Term Note

On the 2012 Transaction Completion Date, in connection with the 2012 Transaction, the Senior Secured Notes Issuer purchased an NIS 1,900 million (€408 million equivalent) intercompany term note (the “HOT Proceeds Term Note”) issued by HOT.

Interest

The HOT Proceeds Term Note bears interest at a rate of 6.3% per annum, which is payable semi-annually in cash in arrears on the date which is two business days prior to each June 15 and December 15, commencing on the date which is two business days prior to June 15, 2013 and shall be calculated on the basis of a three hundred and sixty (360) day year composed of twelve (12) months of thirty (30) days each. Interest accrues from 2012 Transaction Completion Date. The maturity date of the HOT Proceeds Term Note is the same as the maturity date of the 2012 Senior Secured Notes.

Guarantees and Security

The HOT Proceeds Term Note is a senior obligation of HOT and is guaranteed on a senior basis by the HOT Refinancing Note Guarantors. The HOT Proceeds Term Note is secured by a pledge over substantially all of the assets of the HOT and the HOT Refinancing Note Guarantors (including all of the share capital of HOT Mobile) but, in each case, excluding (a) licenses issued by the Israeli Ministry of Communications, which are not assignable as a matter of law, and (b) certain end-user equipment (the “HOT Refinancing Note Collateral”).

Repayment

HOT may not prepay the HOT Proceeds Term Note except (i) in the event of a Change of Control, as defined in the HOT Proceeds Term Note, (ii) upon certain asset sales and (iii) if duly approved by HOT and required in order to facilitate or accommodate a repayment of the 2012 Senior Secured Notes by the Senior Secured Notes Issuer.

Change of Control

If a change of control occurs, the Senior Secured Notes Issuer will have the right to require HOT to prepay all or any part of the HOT Proceeds Term Note, together with a premium of 1% of the principal amount of the HOT Proceeds Term Note prepaid, plus accrued and unpaid interest, to the date of prepayment.

Change of Control is defined as

- (a) the consummation of any transaction (including, without limitation, any merger or consolidation), the result of which is that any Person (as defined in the HOT Proceeds Term Note, including any “person” (as that term is used in Section 13(d)(3) of the Exchange Act)) other than one or more Permitted Holders (as defined in the HOT Proceeds Term Note) becomes the Beneficial Owner, directly or indirectly, of more than 50% of the issued and outstanding Voting Stock of HOT, measured by voting power rather than number of shares; or
- (b) the direct or indirect sale, lease, transfer, conveyance or other disposition (other than by way of merger, consolidation or other business combination transaction), in one or a series of related transactions, of all or substantially all of the assets of HOT and its restricted subsidiaries taken as a whole to a Person (including any “person” as defined above), other than a Permitted Holder.

Covenants and Events of Default

HOT has agreed, and has agreed to cause each of its subsidiaries, for the sole benefit of the Senior Secured Notes Issuer, (i) to be bound by the covenants in Article 4 (*Covenants*) and Article 5 (*Merger and Consolidation*) of the 2012 Senior Secured Notes Indenture that are applicable to HOT and its subsidiaries as Restricted Subsidiaries (as defined in the 2012 Senior Secured Notes Indenture), (ii) if duly appointed as Paying Agent under the 2012 Senior Secured Notes Indenture, to be bound by the obligations in the 2012 Senior Secured Notes Indenture relating thereto and (iii) to comply with the obligations set forth in the section to be titled “Collateral and Security Documents” in the 2012 Senior Secured Notes Indenture.

The HOT Proceeds Term Note contains events of default, substantially similar to those contained in the 2012 Senior Secured Notes Indenture which, if such event of default occurs, permits the Senior Secured Notes Issuer to declare the HOT Proceeds Term Note due and payable immediately. However, upon an event of default under the New Notes (or any other senior secured debt), HOT and its subsidiaries shall not be liable in any way, including by way of cross-default, and shall not be required to repay any amounts outstanding, including any repayment premiums and accrued and unpaid interest thereon, under the New Notes (or any other senior secured debt). Further, the HOT Refinancing Note Guarantors will only guarantee HOT’s obligations under the HOT Refinancing Notes (the “HOT Refinancing Note Guarantees”). The HOT Refinancing Note Guarantees will be limited to an aggregate amount equal to the amount outstanding under the HOT Refinancing Notes which may vary from time to time in accordance with the terms of the HOT Refinancing Notes. HOT and the HOT Refinancing Note Guarantors will only have liability to the holders of the Senior Secured Notes in the event of an event of default under the HOT Refinancing Notes, in each case, indirectly as a result of an assignment of the HOT Refinancing Notes and/or the ability of the holders of the 2012 Senior Secured Notes to direct the actions of the Senior Secured Notes Issuer in connection with the HOT Refinancing Notes in accordance with the terms of the Intercreditor Agreement, to the extent permitted thereby. The 2012 Senior Notes, the 2013 June Senior Notes and the New Senior Notes will not benefit from any assignment of the HOT Refinancing Notes.

Limitation of Liability

For the avoidance of doubt and without in any way limiting HOT’s and the HOT Refinancing Note Guarantors’ obligations to the Senior Secured Notes Issuer pursuant to the HOT Proceeds Term Note, in any event, including in the event of a default by HOT and/or the HOT Refinancing Note Guarantors under the HOT Proceeds Term Note, or by the Senior Secured Notes Issuer under the 2012 Senior Secured Notes or the 2012 Revolving Credit Facility or the relevant borrower under the Cool Proceeds Note, the Acquisition Proceeds Note or any documents related to any of the foregoing, HOT and the HOT Refinancing Note Guarantors shall not be liable in any way, including by way of cross default, and shall not be required to repay any amounts outstanding, any repayment premiums and accrued and unpaid interest thereon, under the 2012 Senior Secured Notes, the 2012 Revolving Credit Facility, the Cool Proceeds Note and the Acquisition Proceeds Note or any documents related to any of the foregoing. It is further clarified that the HOT Refinancing Note Guarantors serve as guarantors only with respect to the HOT’s debt obligation under the HOT Proceeds Term Note.

Conflicts

For the avoidance of doubt, and despite HOT not being party to such agreements, other than with respect to the covenants described above, in the event that any of the other terms or provisions of this HOT Proceeds Term Note conflict with any terms or provisions of the 2012 Senior Secured Notes Indenture, Intercreditor Agreement or related agreements that are applicable to HOT and the HOT Proceeds Term Note, the Senior Secured Notes Issuer has agreed and acknowledged that (as between HOT and the Senior Secured Notes Issuer only) the terms or provisions of the HOT Proceeds Term Note shall prevail.

HOT Refinancing RCF Note

On the 2012 Transaction Completion Date, in connection with the 2012 Transaction, the Senior Secured Notes Issuer purchased an intercompany revolving credit facility note (the “HOT Refinancing RCF Note” and, together with the HOT Proceeds Term Note, the “HOT Refinancing Notes”) issued by HOT pursuant to which the Senior Secured Notes Issuer may make available to HOT amounts borrowed by the Senior Secured Notes Issuer under the 2012 Revolving Credit Facility Agreement. The HOT Refinancing RCF Note contains substantially similar terms as the HOT Proceeds Term Note except that, in addition to the covenants contained in the HOT Proceeds Term Note, the HOT Refinancing RCF Note contains one leverage based maintenance covenant. The HOT Refinancing RCF Note is guaranteed by the HOT Refinancing Note Guarantors and secured by the same HOT Refinancing Note Collateral that secures the HOT Refinancing Term Note.

Senior Notes Proceeds Loans

The Senior Notes Proceeds Loans comprise of the following:

- (i) On the 2012 Transaction Completion Date, in connection with the 2012 Transaction, the Senior Notes Issuer made an intercompany loan (the “2012 Senior Notes Proceeds Loan”) in aggregate principal amount of approximately \$425 million pursuant to which it loaned the proceeds of the offering of the 2012 Senior Notes to the Senior Secured Notes Issuer.
- (ii) On July 2, 2013 the Senior Notes Issuer made an intercompany loan of €250 million pursuant to which the proceeds of the 2013 June Senior Notes were loaned to the Senior Secured Notes Issuer (the “2013 June Senior Notes Proceeds Loan”).
- (iii) On December 12, 2013 the Senior Notes Issuer made an intercompany loan of \$400 million pursuant to which the proceeds of the 2013 December Senior Notes were loaned to the Senior Secured Notes Issuer (the “2013 December Senior Notes Proceeds Loan”, and, together with the 2012 Senior Notes Proceeds Loan and the 2013 June Senior Notes Proceeds Loan (the “Existing Senior Notes Proceeds Loans”).
- (iv) Upon release of the proceeds of the New Senior Notes from escrow, the Senior Notes Issuer will make an intercompany loan to the Senior Secured Notes Issuer pursuant to which it will loan such proceeds to the Senior Secured Notes Issuer (the “New Senior Proceeds Loan” and, together with the Existing Senior Notes Proceeds Loans, the “Senior Notes Proceeds Loans”). The terms of the Senior Notes Proceeds Loans are customary for intercompany proceeds loans. The 2012 Senior Notes Proceeds Loan accrues interest at a rate equal to the interest rate of the 2012 Senior Notes. The maturity date of the 2012 Senior Notes Proceeds Loan is the same as the maturity date of the 2012 Senior Notes. The 2013 June Senior Notes Proceeds Loan accrues interest at a rate equal to the interest rate of the 2013 June Senior Notes. The maturity date of the 2013 June Senior Notes Proceeds Loan is the same as the maturity date of the 2013 June Senior Notes. The 2013 December Senior Notes Proceeds Loan accrues interest at a rate equal to the interest rate of the 2013 December Senior Notes. The maturity date of the 2013 December Senior Notes Proceeds Loan is the same as the maturity date of the 2013 December Senior Notes. The New Senior Notes Proceeds Loan will accrue interest at a rate equal to the interest rate of the New Senior Notes. The maturity date of the New Senior Notes Proceeds Loan will be the same as the maturity date of the New Senior Notes. Payments on the Senior Notes Proceeds Loan are subject to the Intercreditor Agreement.

Additional Intercompany Proceeds Loans

On the 2012 Transaction Completion Date, the Senior Secured Notes Issuer made intercompany proceeds loans, in addition to the HOT Refinancing Note, to certain entities in the Group with the proceeds of the 2012 Senior Secured Notes and the 2012 Senior Notes Proceeds Loan.

On July 2, 2013 the Senior Secured Notes Issuer made an intercompany loan to Altice Holdings with the proceeds of the 2013 June Senior Notes and the 2013 Term Loan. Altice Holdings made additional intercompany proceeds loans (or subscriptions to bonds), including the ABO Proceeds Loan, the New Cabovisão Proceeds Notes, the Altice West Europe Proceeds Loan, the Outremer Proceeds Loans, the Le Cable Proceeds Loans and the Onitecom Proceeds Notes (together with the Original Cabovisão Proceeds Notes, the “Covenant Party Pledged Proceeds Loans”) to certain entities in the Group in connection with consummation of the 2013 June Transactions.

On December 12, 2013 the Senior Secured Notes Issuer made intercompany proceeds loans to certain entities in the Group with the proceeds of the 2013 December Senior Secured Notes and the 2013 June Senior Notes Proceeds Loan in connection with the consummation of the Tricom Acquisition and the ODO Acquisition.

On December 2, 2014, in connection with the repayment of the Existing Coditel Mezzanine Facility Agreement, the Senior Secured Notes Issuer made intercompany proceeds loans to Altice Holdings in an aggregate principal amount of €126 million. Altice Holdings further on-lent this amount through two intercompany proceeds loans of €19 approximately million and approximately €107 million.

In connection with the New Transactions, the Senior Secured Notes Issuer will use amounts borrowed under the New Senior Notes Proceeds Loan, the proceeds of the offering of the New Senior Secured Notes, amounts borrowed under the New Term Loan and any amounts borrowed under the New Super Senior Revolving Credit Facility to make a proceeds loan (the “New AH Proceeds Loan”) to Altice Holdings. Altice Holdings will use the proceeds under the New AH Proceeds Loan and the ASA Notes Proceeds Contribution to make the AWE Proceeds Loan to Altice West Europe which in turn will make the AP Proceeds Loan to Altice Portugal to consummate the PT Portugal Acquisition. Furthermore,

Altice Portugal, PT Portugal, PT OpCo, PT Móveis and SIRESP intend to enter into the PT Group Loans as part of the PT Portugal Acquisition.

These loans (other than the AP Proceeds Loan and the PT Group Loans) are pledged as security for the Senior Secured Debt. The 2013 June Senior Notes, 2013 December Senior Notes, the 2012 Senior Notes and the New Senior Notes do not benefit from any security over the intercompany proceeds loans granted by the Senior Secured Notes Issuer. For further details, see “—*Corporate and Financing Structure*”.

DESCRIPTION OF SENIOR SECURED NOTES

You will find definitions of certain capitalized terms used in this “Description of Senior Secured Notes” under the heading “Certain Definitions”. Certain capitalized terms used in this “Description of Senior Secured Notes” may have different definitions than the same term used in other sections of this Offering Memorandum, including “Description of Senior Notes”. For purposes of this “Description of Senior Secured Notes”, references to the “Issuer” refer only to Altice Financing S.A.

Altice Financing S.A., a Luxembourg public limited liability company (*société anonyme*), with registered office at 3 Boulevard Royal, L-2449 Luxembourg (the “Issuer”) will be the issuer of the Notes offered hereby. The Issuer is a wholly owned subsidiary of Altice Finco S.A., a Luxembourg public limited liability company (*société anonyme*), with registered office at 3 Boulevard Royal, L-2449 Luxembourg (“HoldCo”).

The Issuer has issued \$2,060 million aggregate principal amount of its U.S. dollar-denominated Senior Secured Notes due 2023 (the “Dollar Notes”) and €500 million aggregate principal amount of its euro-denominated Senior Secured Notes due 2023 (the “Euro Notes”) and, together with the Dollar Notes, the “Notes”) under an indenture (the “Indenture”), between, *inter alios*, itself, Altice International S.à r.l. (“Altice International”), a private limited company (*société a responsabilité limitée*) incorporated under the laws of Luxembourg, registered with the Luxembourg Register of Commerce and Companies under number B143.725, and Deutsche Bank AG, London Branch, as trustee (the “Trustee”), Deutsche Bank AG, London Branch as Principal Paying Agent and Deutsche Bank Luxembourg, S.A. as Euro Transfer Agent and Euro Registrar, Deutsche Bank Trust Company Americas as US Paying Agent, US Transfer Agent and US Registrar and Citibank, N.A., London Branch, as security agent (“Security Agent”) and Altice Finco S.A. (“HoldCo”) has issued \$385 million aggregate principal amount of its 7.625% Senior Notes due 2025 (the “New Senior Notes”) under an indenture (the “New Senior Notes Indenture”), between, *inter alios*, itself, Altice International and Deutsche Bank AG, London Branch, as trustee (the “New Senior Notes Trustee”), Deutsche Bank Trust Company Americas as US Paying Agent, US Transfer Agent and US Registrar and Citibank, N.A., London Branch, as security agent, in each case, in a private transaction that is not subject to the registration requirements of the Securities Act. The gross proceeds of the offering of the New Senior Notes sold on the Issue Date will be loaned by HoldCo to the Issuer pursuant to a proceeds loan (a “HoldCo Proceeds Loan”) upon release of such proceeds from the New Senior Notes Escrow Account (as defined below), as described herein.

Subject to the following three paragraphs, the net proceeds of the offering of the Notes sold on the Issue Date and the net proceeds of the HoldCo Proceeds Loan will be loaned pursuant to the Issuer Proceeds Loans described under the heading “—The Issuer Proceeds Loans” to Altice Holdings to enable Altice Holdings to:

- (1) directly or indirectly to acquire (the “Acquisition”) 100% of the outstanding Capital Stock of PT Portugal SGPS, S.A. (the “Target”), together with certain entities identified in the Acquisition Agreement (as defined below) as “Companies within the Transaction Perimeter” (collectively, the “PT Portugal Group”), from Oi, S.A. (the “Seller”) pursuant to the terms of an agreement dated December 9, 2014 among Altice S.A., Altice Portugal and the Seller (the “Acquisition Agreement”); and
- (2) pay fees and expenses related to the foregoing,

(herein referred to collectively as the “Transactions”) as described in this Offering Memorandum under “The Transactions” and “Use of Proceeds”. The date on which the Acquisition is consummated is herein referred to as the “Completion Date”.

The initial purchasers have, concurrently with the closing of the offering of the Notes on the Issue Date, deposited the gross proceeds of this offering of the Notes into one or more segregated escrow accounts (the “Escrow Accounts”) pursuant to the terms of an escrow agreement (the “Notes Escrow Agreement”) dated as of the Issue Date among, *inter alios*, the Issuer, the Trustee and Deutsche Bank AG, London Branch, as Escrow Agent (the “Escrow Agent”). If the Acquisition is not consummated on or prior to June 9, 2016 (the “Escrow Longstop Date”), or upon the occurrence of certain other events, the Notes will be redeemed at a price equal to 100% of the initial issue price of the Notes plus accrued and unpaid interest and Additional Amounts, if any, from the Issue Date to the Special Mandatory Redemption Date (as defined below). The initial purchasers have, concurrently with the closing of the offering of the New Senior Notes on the Issue Date, deposited the gross proceeds of this offering of the New Senior Notes into a segregated escrow account (the “New Senior Notes Escrow Account”) pursuant to the terms of an escrow agreement (the “New Senior Notes Escrow Agreement”) and together with the Notes Escrow Agreement, the “Escrow Agreements”) dated as of the Issue Date among, *inter alios*, HoldCo, the New Senior Notes Trustee and Deutsche Bank AG, London Branch, as escrow agent.

The completion of the Acquisition is subject to the conditions set out in the Acquisition Agreement, including the separate approval by the competent regulatory authorities in Portugal and merger-control clearance by the European

Commission. As a result, we are unable to predict the date on which the Acquisition will complete. The Escrow Agreements provide that, subject to the conditions in relevant Escrow Agreement all of the proceeds of the Notes held in the Escrow Accounts and all of the proceeds of the New Senior Notes held in the New Senior Notes Escrow Account will be released to consummate the Acquisition, and to pay fees and expenses related to the Transactions.

The release of the proceeds of the offering of the Notes from the Escrow Accounts will be subject to certain conditions. See “*General—Escrow of Proceeds; Special Mandatory Redemption*”.

As of the initial issuance of the Notes, the Notes are obligations solely of the Issuer and are not guaranteed. Although Altice International is party to the Indenture on the Issue Date for purposes of the covenants described below, the Note Guarantee of Altice International will not be effective until the Completion Date (as defined below). Assuming the Completion Date occurs on or prior to the Escrow Longstop Date, on the Completion Date, the Note Guarantee of Altice International will become effective and each of Cool, H. Hadaros 2012, Ltd., Altice Holdings, Altice West Europe, Altice Caribbean, Green, Altice Bahamas, Tricom, Global Interlink, ODO and Winreason, ONI S.G.P.S., Oniteleco, Knewon, Altice Portugal and Cabovisao (subject to the applicable Aggregate Portuguese Security and Guarantee Limit Amount (as defined below)) (collectively, the “*Completion Date Guarantors*”) will execute and deliver a supplemental indenture providing for a Note Guarantee on a senior basis. Within 90 days following the Completion Date, PT Portugal and PT OpCo (the “*Post-Completion Date Guarantors*”) will execute and deliver a supplemental indenture providing for a Note Guarantee on a senior basis, subject to the applicable Aggregate Portuguese Security and Guarantee Limit (the date on which the Post-Completion Date Guarantor executes such supplemental indenture being the “*Post-Completion Guarantor Accession Date*”).

The Indenture is unlimited in aggregate principal amount and € 2,317 million equivalent in principal amount of Notes, comprising of \$2,060 million aggregate principal amount of Dollar Notes and €500 million aggregate principal amount of Euro Notes, were issued in this offering. We may issue an unlimited principal amount of additional Notes at later dates under the same Indenture (the “*Additional Notes*”); *provided, however*, that we will only be permitted to issue Additional Notes in compliance with the covenants contained in the Indenture, including the covenants restricting the Incurrence of Indebtedness (as described below under “*Certain Covenants—Limitation on Indebtedness*”) and the Incurrence of Liens (as described below under “*Certain Covenants—Limitation on Liens*”). The Notes issued in this offering and, if issued, any Additional Notes will be treated as a single class for all purposes under the Indenture, including, without limitation, with respect to waivers, amendments, redemptions and offers to purchase, except as otherwise stated in the Indenture. However, in order for any Additional Notes denominated in U.S. dollars or euro to have the same CUSIP number and ISIN as the Dollar Notes or the Euro Notes, as applicable, such Additional Notes must be fungible with the Notes for U.S. federal income tax purposes. Unless the context otherwise requires, in this “*Description of Senior Secured Notes*”, references to the “*Notes*” include the Notes and any Additional Notes that are actually issued. The terms of the Notes include those set forth in the Indenture. The Indenture is not qualified under, and will not incorporate by reference any of the provisions of, and is not required to be subject to, the U.S. Trust Indenture Act of 1939, as amended.

This “*Description of Senior Secured Notes*” is intended to be an overview of the material provisions of the Notes and the Indenture, and refers to the Intercreditor Agreement, the Notes Escrow Agreement and the Security Documents (as defined below). It does not restate those agreements in their entirety. Since this description of the terms of the Notes is only a summary, you should refer to the Indenture, the form of Notes, the Intercreditor Agreement, the Notes Escrow Agreement and the Security Documents for complete descriptions of the obligations of the Issuer and your rights because they, and not this summary, define your rights as holders of the Notes. Copies of the Indenture, the form of Notes, the Security Documents, the Notes Escrow Agreement and the Intercreditor Agreement are available as set forth under “*Available Information*”. See the section entitled “*Description of Other Indebtedness—Intercreditor Agreement*” for a summary of certain material terms of the Intercreditor Agreement.

The registered holder of a Note will be treated as the owner of such Note for all purposes. Only registered holders will have rights under the Indenture.

General

The Notes

The Notes:

- are general obligations of the Issuer;
- are, prior to the Completion Date, be secured by a first ranking assignment over the Escrowed Property (as defined below) and the rights of the Issuer under the Notes Escrow Agreement;

- will, as of the Completion Date, be guaranteed by the Completion Date Guarantors and within 90 days after the Completion Date (if it occurs), the Notes will be guaranteed by the Post-Completion Date Guarantors and benefit from the security as set forth below under “—Notes Security”;
- rank *pari passu* in right of payment with all existing and future Indebtedness of the Issuer that is not subordinated in right of payment to the Notes, including Indebtedness under the Existing Senior Secured Notes, the Senior Credit Facilities, the Revolving Credit Facilities, the Guarantee Facility and certain Hedging Obligations;
- rank senior in right of payment to all existing and future Indebtedness of the Issuer that is expressly subordinated in right of payment to the Notes; and
- are effectively subordinated to all existing and future Indebtedness of the Issuer that is secured by property and assets that do not secure the Notes, to the extent of the value of the property and assets securing such Indebtedness.

The Note Guarantees

Subject to the following paragraph, on the Completion Date, the Notes will be guaranteed by the Completion Date Guarantors; *provided that* (i) the Note Guarantees of Cabovisao and Altice Portugal together with their guarantees of obligations under the Revolving Credit Facilities, the Guarantee Facility, the Existing Senior Secured Notes, the Senior Credit Facilities, the New Senior Notes, the Existing Senior Notes, certain Hedging Obligations and certain future Indebtedness that may be incurred shall be limited to €95 million; and (ii) the Note Guarantees of the ONI Group together with their guarantees of obligations under the Revolving Credit Facilities, the Guarantee Facility, the Existing Senior Secured Notes, the Senior Credit Facilities, the New Senior Notes, the Existing Senior Notes, certain Hedging Obligations and certain future Indebtedness that may be incurred shall be limited to €45.8 million. See “*Corporate and Financing Structure*”. None of HOT, Altice Blue Two SAS (“*NewCo OMT*”), ABO or any of their Subsidiaries will Guarantee the Notes.

Within 90 days after the Completion Date (if it occurs), the Notes will be Guaranteed by the Post-Completion Date Guarantors; *provided that* (i) the Note Guarantee of Target, together with its guarantee of obligations under the Revolving Credit Facilities, the Guarantee Facility, the Existing Senior Secured Notes, the Senior Credit Facilities, the New Senior Notes, the Existing Senior Notes, certain Hedging Obligations and certain future Indebtedness that may be incurred shall be limited to € 4,634.4 million; and (ii) the Note Guarantee of PT OpCo, together with its guarantee of obligations under the Revolving Credit Facilities, the Guarantee Facility, the Existing Senior Secured Notes, the Senior Credit Facilities, the New Senior Notes, the Existing Senior Notes, certain Hedging Obligations and certain future Indebtedness that may be incurred shall be limited to €968.4 million. See “*Corporate and Financing Structure*”.

Although the Existing Senior Secured Notes and the other outstanding secured Indebtedness of Issuer referred to above are guaranteed by ABO, because of applicable restrictions under French law related to corporate benefit, the Notes will not be guaranteed by ABO.

Each Note Guarantee of the Notes:

- be a general obligation of the relevant Guarantor;
- rank *pari passu* in right of payment with all existing and future Indebtedness of that Guarantor that is not subordinated in right of payment to such Guarantor’s Note Guarantee, including such Guarantor’s Guarantee of the Issuer’s Indebtedness under the Existing Senior Secured Notes, the Senior Credit Facilities, the Revolving Credit Facilities, the Guarantee Facility and certain Hedging Obligations;
- rank senior in right of payment to all existing and future obligations of that Guarantor that is expressly subordinated in right of payment to such Note Guarantee;
- benefit from the security as set forth below under “—Notes Security”;
- be effectively subordinated to all existing and future Indebtedness of that Guarantor that is secured by liens on property or assets that do not secure that Guarantor’s guarantee, to the extent of the value of the property or assets securing such Indebtedness; and
- be effectively subordinated to the Indebtedness and other obligations of Subsidiaries of Altice International that do not Guarantee the Notes.

The Notes will not benefit from a direct guarantee from HOT or any of its Subsidiaries, NewCo OMT or any of its Subsidiaries or Coditel Holdco or any of its Subsidiaries. However, as a result of the pledge of:

- the HOT Proceeds Note on December 27, 2012, the Notes will indirectly benefit from the HOT Proceeds Note and the HOT Proceeds Note Guarantees by the HOT Proceeds Note Guarantors;
- as a result of the pledge of the OMT Proceeds Loans on July 5, 2013, the Notes will indirectly benefit from the OMT Proceeds Loans; and
- as a result of the pledge over the loans outstanding under the Coditel Senior Credit Facility (all of which are held by Altice Holdings), the Notes will indirectly benefit from the loans under the Coditel Senior Credit Facility.

In addition, the Existing HOT Unsecured Notes will rank *pari passu* with the HOT Proceeds Note to the extent the amount of the HOT Proceeds Note exceeds the value of the assets of the HOT Proceeds Note Obligor and will rank effectively senior to the Notes and the Note Guarantees of the Guarantors in respect of such assets. As of September 30, 2014, the total principal amount of the Existing HOT Unsecured Notes outstanding was approximately NIS 1,188 million.

Further, the obligations of a Guarantor under its Note Guarantee will be limited as necessary to prevent the relevant Note Guarantee from constituting a fraudulent conveyance under applicable law, or otherwise to reflect limitations under applicable law or capital maintenance regulations. See “*Risk Factors—Risks Relating to the New Notes and the Structure—Each Guarantee will be subject to certain limitations on enforcement and may be limited by applicable laws or subject to certain defenses that may limit its validity and enforceability*” and “*Limitation on Validity and Enforceability of the Guarantees and the Security Interests*”.

As of September 30, 2014, on an as-adjusted consolidated basis after giving effect to the Transactions, including the issuance of the Notes, the New Senior Notes and the amounts expected to be drawn under the Additional Revolving Credit Facilities to consummate the Acquisition and the application of the proceeds therefrom as described under “Use of Proceeds” elsewhere in this Offering Memorandum, Altice International and its Restricted Subsidiaries would have had outstanding €7,425 million equivalent aggregate principal amount of Indebtedness if the Acquisition is consummated. As of September 30, 2014, on an as-adjusted basis after giving effect to the Transactions, including the issuance of the Notes, the incurrence of the HoldCo Proceeds Loan and the amounts expected to be drawn under the Additional Revolving Credit Facilities to consummate the Acquisition and the application of the proceeds therefrom, the Issuer would have had €5,862 million equivalent aggregate principal amount of outstanding Indebtedness (in each case, excluding Guarantees of the Indebtedness of Holdco).

Each of Altice International, Altice Holdings, Altice West Europe, Altice Caribbean, NewCo OMT, Altice Portugal, Cool, H. Hadaros 2012, Ltd., the Target and certain other Guarantors is a holding company and does not conduct any operations and is wholly dependent on payments from its respective Subsidiaries to meet its obligations, including under its Note Guarantee and any Issuer Proceeds Loan to which it is a party.

Principal and Maturity

The Issuer issued \$2,060 million aggregate principal amount of Dollar Notes and €500 million aggregate principal amount of Euro Notes on the Issue Date. The Notes will mature on February 15, 2023 at which time 100% of the principal amount of the Notes shall be payable, unless redeemed prior thereto as described herein. The Notes are issued in minimum denominations of \$200,000 and in integral multiples of \$1,000 in excess thereof, and the Euro Notes are issued in minimum denominations of € 100,000 and in integral multiples of €1,000 in excess thereof.

Interest

Interest on the Dollar Notes will accrue at the rate of 6.625% per annum. Interest on the Euro Notes will accrue at the rate of 5.250% per annum.

Interest on the Notes will:

- accrue from the date of original issuance or, if interest has already been paid, from the date it was most recently paid;
- be payable in cash semi-annually in arrears on each April 1 and October 1, commencing on October 1, 2015;
- be payable to the holder of record of such Notes on March 15 and September 15 immediately preceding the related interest payment date; and

- be computed on the basis of a 360-day year comprised of twelve 30-day months.

Interest on overdue principal and interest, including Additional Amounts, if any, will accrue at a rate that is 1% higher than the interest rate on the Notes.

If the due date for any payment in respect of any Notes is not a Business Day at the place at which such payment is due to be paid, the Holder thereof will not be entitled to payment of the amount due until the next succeeding Business Day at such place, and will not be entitled to any further interest or other payment as a result of any such delay.

Methods of Receiving Payments on the Notes

Principal, interest and premium, if any, on the Global Notes (as defined below) will be payable at the specified office or agency of one or more Paying Agents; *provided* that payments on the Dollar Global Notes (as defined below) will be made to Cede & Co. as the registered holder of the Dollar Global Notes, and payments on the Euro Global Notes (as defined below) will be made to the Paying Agent, which will in turn make such payments to Euroclear and Clearstream (in the case of the Euro Global Notes) and DTC or its nominee (in the case of the Dollar Global Notes).

Principal, interest and premium, if any, on any certificated securities (“*Definitive Registered Notes*”) will be payable at the specified office or agency of one or more Paying Agents maintained for such purposes in New York, New York and London, United Kingdom. In addition, at the option of the Issuer, interest on the Definitive Registered Notes may be paid by check mailed to the Person entitled thereto as shown on the register for the Definitive Registered Notes. See “—*Paying Agent and Registrar for the Notes*”.

Paying Agent and Registrar for the Notes

The Issuer will maintain one or more paying agents for the Notes (each, a “*Paying Agent*” and together, the “*Paying Agents*”) in (i) the City of London, United Kingdom (the “*Principal Paying Agent*”) and (ii) New York. The Issuer will also undertake to maintain a Paying Agent in a European Union member state that will not be obliged to withhold or deduct tax pursuant to the European Union Directive 2003/48/EC (as amended from time to time) or any other directive implementing the conclusions of the ECOFIN Council meeting of 26 and 27 November 2000 regarding the taxation of savings income (the “*Directive*”), or any law implementing or complying with or introduced in order to conform to such Directive. The Principal Paying Agent will be Deutsche Bank AG, London Branch in London and the U.S. Paying Agent will be Deutsche Bank Trust Company Americas in New York.

The Issuer will also maintain one or more registrars (each, a “*Registrar*”). The initial Registrars will be Deutsche Bank Luxembourg S.A., in the case of the Euro Notes, and Deutsche Bank Trust Company Americas, in the case of the Dollar Notes. The Issuer will also maintain one or more transfer agents (each, a “*Transfer Agent*”). The initial transfer agents will be Deutsche Bank AG, London Branch, in the case of the Euro Notes, and Deutsche Bank Trust Company Americas, in the case of the Dollar Notes. The Registrar will maintain a register reflecting ownership of Definitive Registered Notes (as defined herein) outstanding from time to time, if any, and will facilitate transfers of Definitive Registered Notes on behalf of the Issuer. Each transfer agent shall perform the functions of a transfer agent. Each Registrar shall provide a copy of the register and any update thereof to the Issuer and the Issuer shall maintain a register of the Notes at its registered office in order to comply with Luxembourg law (the “*Duplicate Register*”). In case of discrepancy between any register and the Duplicate Register, the Duplicate Register shall prevail for Luxembourg law purposes.

The Issuer may change any Paying Agents, Registrars or transfer agents for the Notes without prior notice to the Holders of such Notes. However, for so long as Notes are listed on the Euro MTF Market of the Luxembourg Stock Exchange and the rules of the Luxembourg Stock Exchange so require, the Issuer will publish a notice of any change of Paying Agent, Registrar or transfer agent on the official website of the Luxembourg Stock Exchange (www.bourse.lu), to the extent and in the manner permitted by the rules and the regulations of the Luxembourg Stock Exchange. The Issuer or any of its Subsidiaries may act as Paying Agent or Registrar in respect of the Notes.

Transfer and Exchange

The Notes have been issued in the form of several registered notes in global form, without interest coupons, as follows:

- Each series of Notes sold within the United States to qualified institutional buyers pursuant to Rule 144A under the Securities Act will initially be represented by a global note in registered form without interest coupons attached (the “144A Global Notes”).
- The 144A Global Notes representing the Dollar Notes (the “Dollar 144A Global Note”), were deposited with a custodian for The Depository Trust Company (“DTC”) and registered in the name of Cede & Co., as nominee of DTC on the Issue Date.

- The 144A Global Notes representing the Euro Notes (the “Euro 144A Global Note”), were deposited with and registered in the name of the nominee of the common depository for the accounts of Euroclear Bank SA/NV (“Euroclear”) and Clearstream Banking, société anonyme (“Clearstream”) on the Issue Date.
- Each series of Notes sold outside the United States pursuant to Regulation S under the Securities Act will initially be represented by a global note in registered form without interest coupons attached (the “Regulation S Global Notes” and together with the 144A Global Notes, the “Global Notes”).
- During the 40-day “distribution compliance period” (as such term is defined in Rule 902 of Regulation S under the Securities Act), the Regulation S Global Notes representing the Dollar Notes (the “Dollar Regulation S Global Note,” and together with the Dollar 144A Global Note, the “Dollar Global Notes”) will initially be credited within DTC for the accounts of Euroclear and Clearstream. After the 40-day distribution compliance period ends, investors may also hold their interests in the permanent Dollar Regulation S Global Note through organizations other than Clearstream or Euroclear that are DTC participants.
- The Regulation S Global Notes representing the Euro Notes (the “Euro Regulation S Global Note”, and together with the Euro 144A Global Note, the “Euro Global Notes”) will, on the closing date, be deposited with and registered in the name of the nominee of the common depository for the accounts of Euroclear and Clearstream.

During the 40-day distribution compliance period, book-entry interests in the Regulation S Global Note may be (1) held only through Euroclear and Clearstream or through DTC for the account of Euroclear and Clearstream, and (2) transferred only to non-U.S. persons under Regulation S or qualified institutional buyers under Rule 144A. Ownership of interests in the Global Notes (“Book-Entry Interests”) will be limited to persons that have accounts with Euroclear, Clearstream or DTC, as applicable, or persons that may hold interests through such participants. Ownership of interests in the Book-Entry Interests and transfers thereof will be subject to the restrictions on transfer and certification requirements summarized below and described more fully under “*Transfer Restrictions*”. In addition, transfers of Book-Entry Interests between participants in Euroclear, participants in Clearstream or participants in DTC will be effected by Euroclear, Clearstream or DTC, as applicable, pursuant to customary procedures and subject to the applicable rules and procedures established by Euroclear, Clearstream or DTC, as applicable, and their respective participants.

Book-Entry Interests in the 144A Global Note may be transferred to a person who takes delivery in the form of Book-Entry Interests in the Regulation S Global Note denominated in the same currency only upon delivery by the transferor of a written certification (in the form provided in the indenture) to the effect that such transfer is being made in accordance with Regulation S under the Securities Act.

Regulation S Book-Entry Interests may be transferred to a person who takes delivery in the form of 144A Book-Entry Interests only upon delivery by the transferor of a written certification (in the form provided in the Indenture) to the effect that such transfer is being made to a person who the transferor reasonably believes is a “qualified institutional buyer” within the meaning of Rule 144A in a transaction meeting the requirements of Rule 144A or otherwise in accordance with the transfer restrictions described under “*Transfer Restrictions*” and in accordance with any applicable securities law of any other jurisdiction.

Any Book-Entry Interest that is transferred as described in the immediately preceding paragraphs will, upon transfer, cease to be a Book-Entry Interest in the Global Note from which it was transferred and will become a Book-Entry Interest in the Global Note to which it was transferred.

Accordingly, from and after such transfer, it will become subject to all transfer restrictions, if any, and other procedures applicable to Book-Entry Interests in the Global Note to which it was transferred.

If Definitive Registered Notes are issued, they will be issued only in minimum denominations of \$200,000 or €100,000 principal amount, as the case may be, and integral multiples of \$1,000 in excess thereof or € 1,000 in excess thereof, as the case may be, upon receipt by the applicable Registrar of instructions relating thereto and any certificates, opinions and other documentation required by the Indenture. It is expected that such instructions will be based upon directions received by Euroclear, Clearstream or DTC, as applicable, from the participant which owns the relevant Book-Entry Interests. Definitive Registered Notes issued in exchange for a Book-Entry Interest will, except as set forth in the Indenture or as otherwise determined by the Issuer to be in compliance with applicable law, be subject to, and will have a legend with respect to, the restrictions on transfer summarized below and described more fully under “*Transfer Restrictions*”.

Subject to the restrictions on transfer referred to above, Dollar Notes issued as Definitive Registered Notes may be transferred or exchanged, in whole or in part, in minimum denominations of \$200,000 in principal amount and integral multiples of \$1,000 in excess thereof and Euro Notes issued as Definitive Registered Notes may be transferred or exchanged, in whole or in part, in minimum denominations of €100,000 in principal amount and integral multiples of

€1,000 in excess thereof. In connection with any such transfer or exchange, the Indenture requires the transferring or exchanging holder to, among other things, furnish appropriate endorsements and transfer documents, to furnish information regarding the account of the transferee at Euroclear, Clearstream or DTC, as applicable, to furnish certain certificates and opinions, and to pay any taxes, duties and governmental charges in connection with such transfer or exchange. Any such transfer or exchange will be made without charge to the holder, other than any taxes, duties and governmental charges payable in connection with such transfer.

Notwithstanding the foregoing, the Issuer is not required to register the transfer or exchange of any Notes:

- (1) for a period of 15 days prior to any date fixed for the redemption of the Notes;
- (2) for a period of 15 days immediately prior to the date fixed for selection of Notes to be redeemed in part;
- (3) for a period of 15 days prior to the record date with respect to any interest payment date; or
- (4) which the Holder has tendered (and not withdrawn) for repurchase in connection with a Change of Control Offer or an Asset Disposition Offer.

The Issuer, the Trustee, the Paying Agents, the transfer agents and the Registrar will be entitled to treat the registered holder of a Note as the owner of it for all purposes.

The Note Guarantees

General

The Notes were not guaranteed as of the Issue Date. Although Altice International will be a party to the Indenture on the Issue Date for the purposes of the covenants described below, Altice International's Note Guarantee will not be effective until the Completion Date occurs. Following the Completion Date, the Notes will be Guaranteed by the Completion Date Guarantors that grant a Note Guarantee on such date on a senior basis for the full and punctual payment when due, whether at Stated Maturity, by acceleration or otherwise, of all payment obligations of the Issuer under the Indenture and the Notes, whether for payment of principal of or interest on or in respect of the Notes, fees, expenses, indemnification or otherwise. The Note Guarantees of Cabovisao and Altice Portugal together with their guarantees of obligations under the Revolving Credit Facilities, the Guarantee Facility, the Existing Senior Secured Notes, the Senior Credit Facilities, the New Senior Notes, the Existing Senior Notes, certain Hedging Obligations and certain future Indebtedness that may be incurred shall be limited to €95 million. The Note Guarantees of the ONI Group together with their guarantees of obligations under the Revolving Credit Facilities, the Guarantee Facility, the Existing Senior Secured Notes, the Senior Credit Facilities, the New Senior Notes, the Existing Senior Notes, certain Hedging Obligations and certain future Indebtedness that may be incurred shall be limited to approximately €45.8 million.

Within 90 days after the Completion Date (if it occurs), the Notes will be guaranteed by the Post-Completion Date Guarantors. The Note Guarantee of Target, together with its guarantee of obligations under the Revolving Credit Facilities, the Guarantee Facility, the Existing Senior Secured Notes, the Senior Credit Facilities, the New Senior Notes, the Existing Senior Notes, certain Hedging Obligations and certain future Indebtedness that may be incurred shall be limited to €4,634.4 million. The Note Guarantee of PT OpCo, together with its guarantee of obligations under the Revolving Credit Facilities, the Guarantee Facility, the Existing Senior Secured Notes, the Senior Credit Facilities, the New Senior Notes, the Existing Senior Notes, certain Hedging Obligations and certain future Indebtedness that may be incurred shall be limited to €968.4 million.

On the Issue Date and the Completion Date, the Notes did not and will not benefit from a direct guarantee from HOT or any of its Subsidiaries, from NewCo OMT or any of its Subsidiaries, from ABO or any of its Subsidiaries or from Coditel Holdco or any of its Subsidiaries.

The obligations of each Guarantor under its Note Guarantee are or will be, as applicable, contractually limited under the applicable guarantees to reflect limitations under applicable law with respect to maintenance of share capital applicable to such Guarantor and its shareholders, directors and general partners. See "*Limitation on Validity and Enforceability of the Guarantees and the Security Interests*".

The Issuer is a special purpose finance vehicle formed for the purpose of serving as the issuer of the Notes and does not conduct, and will be prohibited by the Indenture from engaging in, any operations. Upon completion of the Transactions, the Issuer's only assets will be the Issuer Proceeds Loans made on December 27, 2012; July 2, 2013; July 5, 2013; August 8, 2013; March 12, 2014; April 9, 2014; and the Completion Date, if it occurs, and cash in its bank accounts. As a result, the Issuer is wholly dependent on payments from Altice International and the other Restricted Subsidiaries,

including payments made by the borrowers under the Issuer Proceeds Loans, to fund its obligations, including its obligations under the Notes, to the extent it does not otherwise have funds available to it.

The operations of each of Altice International and each of the other Guarantors that are holding companies are conducted through their respective Subsidiaries and, therefore, each of Altice International and such other Guarantors depend on the cash flow of their respective Subsidiaries to meet their respective obligations, including their obligations under Note Guarantees and the Issuer Proceeds Loans to which they are a party. See “*Risk Factors—Risks Relating to the New Notes and the Structure—Altice International and most of the other Guarantors are holding companies and conducts no business of their own and will depend on payments from their direct and indirect subsidiaries to provide them with funds to meet their obligations under the Guarantees.*”

The Note Guarantees will be effectively subordinated to the Existing HOT Unsecured Notes. The Existing HOT Unsecured Notes will not be subject to the Intercreditor Agreement and, as a result, in the event of an enforcement sale of the shares of Cool, HOT or any of its holding companies, as the case may be, pursuant to the Intercreditor Agreement, the debt claims of the holders of the Existing HOT Unsecured Notes are not required to be released or otherwise transferred. In addition, the Notes and the Note Guarantees will be effectively subordinated in right of payment to all Indebtedness and other liabilities and commitments (including trade payables and lease obligations) of Subsidiaries of Altice International that do not Guarantee the Notes. Any right of the Issuer or any Guarantor to receive assets of any of the Subsidiaries of Altice International that do not Guarantee the Notes upon that non-guarantor Subsidiary’s liquidation or reorganisation (and the consequent right of the holders of the Notes to participate in those assets) will be effectively subordinated to the claims of that non-guarantor Subsidiary’s creditors, except to the extent that the Issuer or such Guarantor is itself recognized as a creditor of the non-guarantor Subsidiary, in which case the claims of the Issuer or such Guarantor, as the case may be, would still be subordinate in right of payment to any security in the assets of the non-guarantor Subsidiary and any Indebtedness of the non-guarantor Subsidiary senior to that held by the Issuer or such Guarantor.

Additional Note Guarantees

Altice International may from time to time designate a Restricted Subsidiary as an additional guarantor of the Notes (the “*Additional Guarantors*”) by causing it to execute and deliver to the Trustee a supplemental indenture in the form attached to the Indenture (and with such documentation relating thereto as the Trustee may reasonably require, including Opinions of Counsel as to the enforceability of such Note Guarantee), pursuant to which such Restricted Subsidiary will become a Guarantor.

Each Additional Guarantor will, jointly and severally, with the Guarantors and each other Additional Guarantor, irrevocably guarantee (each guarantee, an “*Additional Guarantee*”) on a senior basis the full and punctual payment when due, whether at Stated Maturity, by acceleration or otherwise, of all payment obligations of the Issuer under the Indenture and the Notes, whether for payment of principal of or interest on or in respect of the Notes, fees, expenses, indemnification or otherwise. The obligations of any Additional Guarantor will be contractually limited under its Additional Guarantee to reflect limitations under applicable law, including, among other things, with respect to maintenance of share capital applicable to such Additional Guarantor and its shareholders, directors and general partner. Subject to the foregoing, any Additional Guarantee issued by a Restricted Subsidiary shall be issued on substantially the same terms as the Note Guarantees of the Restricted Subsidiaries that will become Guarantors on the Completion Date. For purposes of the Indenture and this “*Description of Senior Secured Notes*”, references to the Note Guarantees include references to any Additional Guarantees and references to the Guarantors include references to any Additional Guarantors.

Releases of the Note Guarantees

The Note Guarantee of Altice International may be released:

- upon legal defeasance, covenant defeasance or satisfaction and discharge of the Indenture, as provided in “*—Defeasance*” and “*—Satisfaction and Discharge*”;
- in accordance with the Intercreditor Agreement or any Additional Intercreditor Agreement;
- as described under “*—Amendments and Waivers*”;
- if Altice International is not the continuing or surviving Person in the relevant consolidation or merger, as a result of a transaction that complies with the provisions described under “*—Merger and Consolidation—Altice International*”; or
- upon the full and final payment and performance of all obligations of the Issuer under the Indenture and the Notes.

The Note Guarantee of a Subsidiary Guarantor will terminate:

- upon a sale or other disposition (including by way of consolidation, merger, amalgamation or combination) of the Capital Stock of the relevant Subsidiary Guarantor (whether by direct sale or sale of a holding company of such Subsidiary Guarantor) or the sale or disposition of all or substantially all the assets of the Subsidiary Guarantor (other than to Altice International or a Restricted Subsidiary), in each case if the sale or other disposition does not violate the covenant described under “—*Certain Covenants—Limitation on Sales of Assets and Subsidiary Stock*”;
- upon the designation in accordance with the Indenture of that Subsidiary Guarantor as an Unrestricted Subsidiary;
- upon legal defeasance, covenant defeasance or satisfaction and discharge of the Indenture, as provided in “—*Defeasance*” and “—*Satisfaction and Discharge*”;
- in accordance with the Intercreditor Agreement or any Additional Intercreditor Agreement;
- as described under “—*Amendments and Waivers*”;
- as described under “—*Certain Covenants—Additional Guarantors*”;
- with respect to any Subsidiary Guarantor that is not the continuing or surviving Person in the relevant consolidation or merger, as a result of a transaction that complies with the provisions described under “—*Merger and Consolidation—The Subsidiary Guarantors*”; or
- upon the full and final payment and performance of all obligations of the Issuer under the Indenture and the Notes.

The Trustee and the Security Agent (as applicable) shall each take all necessary actions, including the granting of releases or waivers under the Intercreditor Agreement or any Additional Intercreditor Agreement, to effectuate any release of a Note Guarantee in accordance with these provisions, subject to customary protections and indemnifications. Each of the releases set forth above shall be effective without the consent of the Holders or any action on the part of the Trustee. Neither the Trustee nor the Issuer will be required to make a notation on the Notes to reflect any such release, termination or discharge.

Notes Security

General

On the Issue Date, the Notes will be secured only by a security interest in the Escrowed Property. The Notes will be secured on a first priority basis:

- (i) on the Completion Date, by:
 - share pledges over all of the Capital Stock of the Issuer and the Completion Date Guarantors (other than Altice International, Green, Cabovisão, Altice Portugal, Winreason, ONI S.G.P.S., Onitelecom and Knewon) (with the share pledges over the share capital of ODO, Tricom and Global Interlink becoming effective upon approval by Indotel);
 - a pledge over the bank accounts and all receivables of the Issuer, including the Issuer Proceeds Loans made on December 27, 2012; July 2, 2013; August 8, 2013; March 12, 2014; April 9, 2014; and the Completion Date;
 - a pledge over substantially all of the material assets of each of the Completion Date Guarantors (other than Cabovisão, Altice Portugal, Winreason, ONI S.G.P.S., Onitelecom and Knewon), including all of the Capital Stock of HOT (other than the Minority Shareholder Call Options and certain management share options) and ABO; *provided that*, to the extent fair market value of a real estate asset owned by ODO, Tricom or Global Interlink, as the case may be, is less than €5 million, such real estate asset shall be excluded from the relevant pledge;
 - a pledge over the HoldCo Proceeds Loans;
 - a pledge over the Subordinated Shareholder Loan;
 - a pledge over the AWE Proceeds Loans;

- a pledge over the Covenant Party Pledged Proceeds Loans (other than the Onitelecom Proceeds Notes and the Cabovisão Proceeds Notes); and
 - a pledge over Altice Portugal’s rights under the Acquisition Agreement;
- (ii) within 10 Business Days following the Completion Date, by a pledge over all of the Capital Stock of the Target; and
- (iii) within 90 days following the Completion Date, by pledges over all of the Capital Stock of PT OpCo, PT Cloud e Data Centers, S.A. (“*PT Cloud*”), and PT—Móveis—Serviços de Telecomunicações, SGPS, S.A. (“*PT Móveis*”),

(the items in (i), (ii) and (iii) above, collectively, the “*Notes Collateral*”)

The Notes Collateral will also secure Indebtedness under the Revolving Credit Facilities, the Existing Senior Secured Notes, the Senior Credit Facilities, the Guarantee Facility and certain Hedging Obligations. The pledge agreements and the other security documents in respect of the Notes Collateral entered into on December 27, 2012; July 2, 2013; July 5, 2013; August 8, 2013; March 12, 2014; April 9, 2014; the Completion Date; and the Post-Completion Guarantor Accession Date (or any other date on which security interests in the Notes Collateral were granted in connection with existing Indebtedness) in respect of the Notes Collateral are referred to as the “*Security Documents*”. Any other additional security interests that may in the future be granted to secure the obligations under the Notes, the Note Guarantees and the Indenture would also constitute Notes Collateral. Other than pursuant to the HOT Proceeds Note, the OMT Proceeds Loans and the Coditel Senior Credit Facility, Altice International has only a shareholder’s claim over the assets of HOT and its Subsidiaries, NewCo OMT and its Subsidiaries and Coditel Holdco and its Subsidiaries, which are junior to the claims that creditors of HOT and its Subsidiaries have against HOT and such Subsidiaries, the claims of the creditors of NewCo OMT and its Subsidiaries have against NewCo OMT and such Subsidiaries and the claims of the creditors of Coditel Holdco and its Subsidiaries have against Coditel Holdco and such Subsidiaries. Holders of the Notes will only be creditors of the Issuer and the Guarantors and will not have any direct claim on the cash flows or assets of HOT and its Subsidiaries, NewCo OMT and its Subsidiaries or Coditel Holdco and its Subsidiaries, and none of HOT, NewCo OMT, Coditel Holdco and their respective Subsidiaries will have any obligation, contingent or otherwise, to pay amounts due under the Notes or the Note Guarantees or to make funds available to the Issuer or the Guarantors for those payments (other than their respective obligations to pay certain amounts due to the Issuer under the HOT Proceeds Note and amounts due to Altice Holdings under the OMT Proceeds Loans and the Coditel Senior Credit Facility).

Although the assets of ABO (including the shares of Green) secure the Existing Senior Secured Notes and the other outstanding secured Indebtedness of the Issuer, because of applicable restrictions under French law related to corporate benefit, such assets will not secure the Notes. Although the assets of certain Portuguese Guarantors, including Altice Portugal, Cabovisão, and ONI, secure the Existing Senior Secured Notes and the other outstanding secured Indebtedness of the Issuer, because of applicable Portuguese law considerations, such assets will not secure the Notes. However, pursuant to the Intercreditor Agreement the holders of the Notes will share in the proceeds of any enforcement of the security interests over such assets in accordance with the terms thereof.

Subject to certain conditions, including compliance with the covenants described under “—*Certain Covenants—Limitation on Liens*” and “—*Certain Covenants—Impairment of Security Interests*”, Altice International and its Restricted Subsidiaries are permitted to incur certain additional Indebtedness in the future that may be secured on the Notes Collateral, including any Additional Notes, certain Indebtedness under Credit Facilities (including revolving credit facility Indebtedness which may be Super Priority Indebtedness) and Hedging Obligations (which in the case of Interest Rate Agreements and Currency Agreements may be Super Priority Indebtedness) and certain other Hedging Obligations (which may be Super Priority Indebtedness), in each case, permitted under the Indenture and other Indebtedness of Altice International and its Subsidiaries. In addition, subject to certain conditions, including compliance with the covenants described under “—*Certain Covenants—Limitation on Liens*” and “—*Certain Covenants—Impairment of Security Interests*”, HOT and its Restricted Subsidiaries are permitted to incur certain additional Indebtedness in the future that may be secured on the HOT Proceeds Note Collateral and NewCo OMT and its Restricted Subsidiaries are permitted to incur certain additional Indebtedness in the future that may be secured on the OMT Proceeds Loans Collateral.

The proceeds from the sale of the Notes Collateral remaining after sharing with other creditors entitled to share in such proceeds may not be sufficient to satisfy the obligations owed to the Holders of the Notes. No appraisals of the Notes Collateral have been made in connection with this offering of Notes. By its nature, some or all of the Notes Collateral will be illiquid and may have no readily ascertainable market value. In addition, certain Liens over the Notes Collateral may not be enforced without the prior consent of the Israeli Minister of Communications, including the Liens over the Capital Stock of HOT and Cool. Accordingly, the Notes Collateral may not be able to be sold in a short period of time, or at all. In addition, the Intercreditor Agreement places limitations on the ability of the Security Agent to release the security interests in some of the Notes Collateral, by reference to the interests of other creditors. These limitations may

include requirements that some or all of the Notes Collateral be disposed of only pursuant to public auctions or only at a price confirmed by a valuation. See *“Description of Other Indebtedness—The Intercreditor Agreement”* and *“Risk Factors—Risks Relating to the New Notes and the Structure—The value of the Collateral may not be sufficient to satisfy our obligations under the New Notes and such Collateral may be reduced or diluted under certain circumstances, which may be time consuming and cumbersome”* and certain Collateral and Guarantees will be limited to a specified maximum amount.

The creditors under the Revolving Credit Facilities, the trustee under the Existing Senior Secured Notes Indenture, the creditors under the Senior Credit Facilities, and the Guarantee Facility, the counterparties to certain Hedging Obligations and the Trustee have, and by accepting a Note, each holder will be deemed to have, irrevocably appointed the Security Agent to act as its agent and security agent under the Intercreditor Agreement and the Security Documents. The creditors under Revolving Credit Facilities, the trustee under the Existing Senior Secured Notes Indenture, the creditors under the Senior Credit Facilities, and the Guarantee Facility, counterparties to certain Hedging Obligations and the Trustee have, and by accepting a Note, each holder will be deemed to have, irrevocably authorized the Security Agent to (i) perform the duties and exercise the rights, powers and discretions that are specifically given to it under the Intercreditor Agreement or the Security Documents, together with any other incidental rights, power and discretions; and (ii) execute each Security Document, waiver, modification, amendment, renewal or replacement expressed to be executed by the Security Agent on its behalf.

Security Documents

Under the Security Documents, the applicable grantor of security has granted or will grant security over the Notes Collateral to secure the payment when due of the Issuer’s and the Guarantors’ payment obligations under the Notes, the Note Guarantees and the Indenture. The Security Documents to be entered into will be, and the existing Security Documents have been, entered into by the relevant security provider and the Security Agent as agent for the secured parties referred to therein. When entering into the Security Documents, the Security Agent has acted and will act in its own name, but also as a representative of the secured parties (including the Holders from time to time). Under the Intercreditor Agreement, the Security Agent will also act on behalf of the holders of the Existing Senior Secured Notes, the Existing Senior Notes, and the New Senior Notes, the lenders under the Revolving Credit Facilities, the Senior Credit Facilities, the Guarantee Facility, the counterparties under certain Hedging Obligations, and holders of any additional Indebtedness that is permitted to be secured by the Notes Collateral in favor of such parties.

The Indenture provides that, subject to the terms thereof, and of the Security Documents and the Intercreditor Agreement, the Notes and the Note Guarantees, as applicable, will be secured by the security interest in the Notes Collateral that is created by the Security Documents and secures obligations under the Notes or the Note Guarantees and the Indenture (the *“Security Interests”*). Such Security Interests in the Notes Collateral will also secure the obligations under the Revolving Credit Facilities, the Existing Senior Secured Notes, the Senior Credit Facilities, the Guarantee Facility, the counterparties to certain Hedging Obligations and certain other Indebtedness permitted by the Indenture to be Incurred in the future and secured by such Notes Collateral. However, the Security Interests may be released under certain circumstances as provided under *“—Release of Note Collateral”* below. See *“Risk Factors—Risks Relating to the New Notes and the Structure—There are circumstances other than repayment or discharge of the New Notes under which the Collateral and the Guarantees will be released automatically, without your consent or the consent of the Trustee”*.

The Security Documents provide that the rights with respect to the Notes and the Note Guarantees must be exercised by the Security Agent. Because the Holders will not be a party to the Security Documents, Holders may not, individually or collectively, take any direct action to enforce any rights in their favor under the Security Documents. The Holders may only act through the Security Agent.

In the event that Altice International, a Subsidiary of Altice International or other grantor of a security interest in the Notes Collateral enters into insolvency, bankruptcy or similar proceedings, the Security Interests created under the Security Documents or the rights and obligations enumerated in the Intercreditor Agreement could be subject to potential challenges. If any challenge to the validity of the Security Interests or the terms of the Intercreditor Agreement were successful, the Holders might not be able to recover any amounts under the Security Documents. See *“Risk Factors—Risks Relating to the New Notes and the Structure—Each Guarantee will be subject to certain limitations on enforcement and may be limited by applicable laws or subject to certain defenses that may limit its validity and enforceability”* and *“Limitation on Validity and Enforceability of the Guarantees and the Security Interests”*.

Release of Notes Collateral

The Issuer and the Guarantors will be entitled to release the Security Interests in respect of the Notes Collateral securing the Notes and the Note Guarantees under any one or more of the following circumstances:

- (1) in connection with (i) any exercise of the Minority Shareholder Call Option or (ii) any other sale or other disposition of the Notes Collateral (other than the pledge over all of the Capital Stock of the Issuer (the “Issuer Share Pledge”)) to a Person that is not Altice International or a Restricted Subsidiary (but excluding any transaction subject to “—*Certain Covenants—Merger and Consolidation*”), if such sale or other disposition does not violate the covenant described under “—*Certain Covenants—Limitation on Sales of Assets and Subsidiary Stock*”, but only in respect of the Notes Collateral sold or otherwise disposed of;
- (2) in connection with the release of a Guarantor from its Note Guarantee pursuant to the terms of the Indenture, the release of the property and assets, and Capital Stock, of such Guarantor;
- (3) if Altice International designates any Restricted Subsidiary to be an Unrestricted Subsidiary in accordance with the applicable provisions of the Indenture, the release of the property, assets and Capital Stock of such Unrestricted Subsidiary (other than the Issuer Share Pledge and the pledges over the HoldCo Proceeds Loans);
- (4) upon legal defeasance, covenant defeasance or satisfaction and discharge of the Indenture, as provided in “—*Defeasance*” and “—*Satisfaction and Discharge*”;
- (5) in accordance with the Intercreditor Agreement or any Additional Intercreditor Agreement (see “*Description of Other Indebtedness—The Intercreditor Agreement—Restrictions on Enforcement*”);
- (6) as described under “—*Amendments and Waivers*”, “—*Certain Covenants—Impairment of Security Interests*” and the second paragraph under “—*Certain Covenants—Limitation on Liens*”;
- (7) upon the full and final payment and performance of all obligations of the Issuer under the Indenture and the Notes
- (8) to release and re-take any Lien on any Notes Collateral to the extent not otherwise prohibited by the terms of the Indenture, the Security Documents or the Intercreditor Agreement or any Additional Intercreditor Agreement;
- (9) in connection with a transaction permitted by the covenant described below under the caption “—*Certain Covenants—Merger and Consolidation*”; or
- (10) with the consent of holders of at least 75% in aggregate principal amount of Notes (including, without limitation, consent obtained in connection with a tender offer or exchange offer for, or purchase of, the Notes);

provided that, the Security Interests created by the Escrow Assignments may only be released upon release of all of the Escrowed Property from the Escrow Accounts in accordance with the terms of the Notes Escrow Agreement.

Upon certification by the Issuer, the Trustee (to the extent action is required by it) and the Security Agent shall take all necessary actions, including the granting of releases or waivers under the Intercreditor Agreement, to effectuate any release in accordance with these provisions, subject to customary protections and indemnifications. The Security Agent and the Trustee (as applicable) will take all necessary action required to effectuate any release of the Notes Collateral, in accordance with the provisions of the Indenture, the Intercreditor Agreement or any Additional Intercreditor Agreement and the relevant Security Document. Each of the releases set forth above shall be effected by the Security Agent without the consent of the Holders or any action on the part of the Trustee.

The Issuer Proceeds Loans

On the December 27, 2012, the Issuer made:

- (1) an Issuer Proceeds Loan to Cool in aggregate principal amount of approximately NIS 1,052.8 million (€220.6 million equivalent as of September 30, 2014);
- (2) an Issuer Proceeds Loan to SPV-1 in aggregate principal amount of approximately NIS 955.5 million (€214.0 million equivalent as of September 30, 2014);
- (3) an Issuer Proceeds Loan to HOT, in aggregate principal amount of approximately NIS 1,900 million (€408.5 million equivalent as of September 30, 2014); and
- (4) a revolving note facility available to HOT in aggregate principal amount of NIS 320 million with each borrowing thereunder to be made pursuant to an Issuer Proceeds Loan.

On July 2, 2013, the Issuer made an Issuer Proceeds Loan to Altice Holdings in aggregate principal amount of €933 million. On August 8, 2013, the Issuer made an Issuer Proceeds Loan to Altice Holdings in aggregate principal amount of €69.2 million. On March 12, 2014, the Issuer made an Issuer Proceeds Loan to Altice Holdings in an aggregate principal amount of €400 million. On April 9, 2014, the Issuer made Issuer Proceeds Loans to Altice Holdings in an aggregate principal amount of €300 million and \$900 million. Upon the Completion Date, the Issuer will make an Issuer Proceeds Loan to Altice Holdings in an aggregate principal amount of €3,724 million equivalent. See “*Description of Other Indebtedness—HOT Refinancing Note*” and “*—Additional Intercompany Proceeds Loans*”.

Each Issuer Proceeds Loan has been or will be assigned as Notes Collateral to secure the Obligations of the Issuer and the Guarantors under the Notes and the Note Guarantees.

Upon an event of default under the Notes, HOT and its Subsidiaries, NewCo OMT and its Subsidiaries and Coditel Holdco and its Subsidiaries shall not be liable in any way, including by way of cross default, and shall not be required to repay any amounts outstanding, any repayment premiums or accrued and unpaid interest thereon, under the Notes. Further, the HOT Proceeds Note Guarantors will only guarantee HOT’s obligations under the HOT Proceeds Note. The HOT Proceeds Note Guarantees will be limited to an aggregate amount equal to the outstanding HOT Proceeds Note, which may vary from time to time in accordance with the terms of the HOT Proceeds Note. Holders of the Notes will only be able to seek remedies against (i) the HOT Proceeds Note Obligors in the event of an event of default under the HOT Proceeds Note, in each case, indirectly as a result of the assignment of the HOT Proceeds Note and/or the ability of the holders of the Notes to direct the actions of the Issuer in connection with the HOT Proceeds Note in accordance with the terms of the Intercreditor Agreement, to the extent permitted thereby; (ii) NewCo OMT or the applicable Restricted Subsidiary of NewCo OMT in the event of an event of default under the applicable OMT Proceeds Loan, in each case, indirectly as a result of the assignment of such OMT Proceeds Loan and/or the ability of the holders of the Notes to direct the actions of Altice Holdings in connection with such OMT Proceeds Loan in accordance with the terms of the Intercreditor Agreement, to the extent permitted thereby; and (iii) Coditel Holdco or the applicable Restricted Subsidiary of Coditel Holdco in the event of an event of default under the Coditel Senior Credit Facility, in each case, indirectly as a result of the assignment of the Coditel Senior Loans and/or the ability of the holders of the Notes to direct the actions of Altice Holdings in connection with the Coditel Senior Loans in accordance with the terms of the Intercreditor Agreement, to the extent permitted thereby.

The Hot Proceeds Note will be effectively subordinated in right of payment to all Indebtedness and other liabilities and commitments (including trade payables and lease obligations) of HOT’s non-guarantor Subsidiaries (including the bank guarantee provided by HOT Mobile to the State of Israel which, based on having achieved a market share calculated in accordance with the license agreement, HOT requested the Israeli Ministry of Communications, and the Israeli Ministry of Communications agreed, to reduce to an amount of NIS 80 million and that is secured by a pledge of all of the assets of HOT Mobile). Any right of the Issuer to receive assets of any of HOT’s non-guarantor Subsidiaries upon that non-guarantor Subsidiary’s liquidation or reorganisation (and the consequent indirect right of the holders of the Notes to participate in those assets) will be effectively subordinated to the claims of that non-guarantor Subsidiary’s creditors, except to the extent that the Issuer is itself recognized as a creditor of the non-guarantor Subsidiary, in which case the claims of the Issuer would still be subordinate in right of payment to any security in the assets of the non-guarantor Subsidiary and any Indebtedness of the non-guarantor Subsidiary senior to that held by the Issuer.

Only the security agent under the HOT Proceeds Note will be able to enforce the security interests in the HOT Proceeds Note Collateral at a time that an event of default under the HOT Proceeds Note is continuing. As a result, upon the occurrence of an Event of Default, the Trustee and the Holders of the Notes will not have the right to enforce such security interests in the HOT Proceeds Note Collateral and, subject to the Intercreditor Agreement, will only have the right to enforce the first-ranking pledge over the HOT Proceeds Note. The Holders of the Notes must then rely on the ability of the Issuer to enforce its rights under the HOT Proceeds Note upon an event of default thereunder in order to access the HOT Proceeds Note Collateral. An Event of Default will not trigger an event of default under the HOT Proceeds Note.

Only the security agent under the OMT Proceeds Loans will be able to enforce the security interests in the OMT Proceeds Loans Collateral at a time that an event of default under the applicable OMT Proceeds Loan is continuing. As a result, upon the occurrence of an Event of Default, the Trustee and the Holders of the Notes will not have the right to enforce such security interests in the OMT Proceeds Loans Collateral and, subject to the Intercreditor Agreement, will only have the right to enforce the first-ranking pledge over the applicable OMT Proceeds Loan. The Holders of the Notes must then rely on the ability of Altice Holdings to enforce its rights under such OMT Proceeds Loan upon an event of default thereunder in order to access the OMT Proceeds Loans Collateral securing such OMT Proceeds Loan. An Event of Default will not trigger an event of default under any OMT Proceeds Loan.

Only the security agent under the Coditel Senior Credit Facility will be able to enforce the security interests in the collateral securing the Coditel Senior Credit Facility (the “*Coditel Collateral*”) at a time that an event of default under the Coditel Senior Credit Facility is continuing. As a result, upon the occurrence of an Event of Default, the Trustee and the

Holders of the Notes will not have the right to enforce such security interests in the Coditel Collateral and, subject to the Intercreditor Agreement, will only have the right to enforce the first-ranking pledge over the loans under the Coditel Senior Credit Facility (the “*Coditel Senior Loans*”). The Holders of the Notes must then rely on the ability of Altice Holdings to enforce its rights under such Coditel Senior Loan upon an event of default thereunder in order to access the Coditel Collateral. An Event of Default may not trigger an event of default under the Coditel Senior Credit Facility.

The HOT Proceeds Note Guarantees

General

The HOT Proceeds Note is guaranteed by the HOT Proceeds Note Guarantors on a senior basis for the full and punctual payment when due, whether at Stated Maturity, by acceleration or otherwise of, all payment obligations of the HOT under the HOT Proceeds Note, whether for payment of principal of or interest on or in respect of the HOT Proceeds Note, fees, expenses, indemnification or otherwise.

The obligations of each HOT Proceeds Note Guarantor under its HOT Proceeds Note Guarantee are contractually limited under the applicable guarantees to reflect limitations under applicable law with respect to maintenance of share capital applicable to such HOT Proceeds Note Guarantor and its shareholders, directors and general partners. See “*Limitation on Validity and Enforceability of the Guarantees and the Security Interests*”.

Additional HOT Proceeds Note Guarantees

HOT may from time to time designate a Restricted Subsidiary of HOT as an additional guarantor of the HOT Proceeds Note, and each such additional HOT Proceeds Note Guarantor will, jointly and severally, with the other HOT Proceeds Note Guarantors, irrevocably guarantee on a senior basis the full and punctual payment when due, whether at Stated Maturity, by acceleration or otherwise, of all payment obligations of HOT under the HOT Proceeds Note, whether for payment of principal of or interest on or in respect of the HOT Proceeds Note, fees, expenses, indemnification or otherwise. The obligations of any such additional HOT Proceeds Note Guarantor will be contractually limited under its guarantee to reflect limitations under applicable law, including, among other things, with respect to maintenance of share capital applicable to such additional HOT Proceeds Note Guarantor and its shareholders, directors and general partner.

Releases of the HOT Proceeds Note Guarantees

The HOT Proceeds Note Guarantee of a HOT Proceeds Note Guarantor may be released:

- upon a sale or other disposition (including by way of consolidation, merger, amalgamation or combination) of the Capital Stock of the relevant HOT Proceeds Note Guarantor (whether by direct sale or sale of a holding company of such HOT Proceeds Note Guarantor) or the sale or disposition of all or substantially all the assets of the HOT Proceeds Note Guarantor (other than to the Issuer, Altice International or a Restricted Subsidiary), in each case if the sale or other disposition does not violate the covenant described under “—*Certain Covenants—Limitation on Sales of Assets and Subsidiary Stock*”;
- upon the designation in accordance with the Indenture of that HOT Proceeds Note Guarantor as an Unrestricted Subsidiary;
- upon legal defeasance, covenant defeasance or satisfaction and discharge of the Indenture, as provided in “—*Defeasance*” and “—*Satisfaction and Discharge*”;
- as described under “—*Amendments and Waivers*”;
- as described under “—*Certain Covenants—Additional Guarantees*”;
- as described under “—*Direct Obligation Events*”
- with respect to any HOT Proceeds Note Guarantor that is not the continuing or surviving Person in the relevant consolidation or merger, as a result of a transaction that complies with the provisions described under “—*Merger and Consolidation—HOT Proceeds Notes Obligors*”;
- upon the full and final payment and performance of all obligations of HOT under the HOT Proceeds Note.

HOT Proceeds Note Security

General

The HOT Proceeds Note and the HOT Proceeds Note Guarantees are secured by Liens over substantially all of HOT's and the HOT Proceeds Note Guarantor's assets but excluding (a) the licenses issued by the Israeli Ministry of Communications, which are not assignable as a matter of law, and (b) certain end-user equipment (the "*Excluded Assets*"). In addition, the HOT Proceeds Note and the HOT Proceeds Note Guarantees are secured by first ranking security interests on a first priority basis over all of the Capital Stock of each HOT Proceeds Note Guarantor. The foregoing property and assets subject to such security interests are referred to herein as the "*HOT Proceeds Note Collateral*". Any other additional security interests that may in the future be granted to secure the HOT Proceeds Note and the HOT Proceeds Note Guarantees would also constitute HOT Proceeds Note Collateral.

Subject to certain conditions, including compliance with the covenants described under "*Certain Covenants—Limitation on Liens*" and "*Certain Covenants—Impairment of Security Interests*", HOT and its Restricted Subsidiaries are permitted to incur certain additional Indebtedness in the future that may be secured on the HOT Proceeds Note Collateral.

The proceeds from the sale of the HOT Proceeds Note Collateral remaining after sharing with other creditors entitled to share in such proceeds may not be sufficient to satisfy the obligations owed to the Issuer as a lender under the HOT Proceeds Note. No appraisals of the HOT Proceeds Note Collateral have been made in connection with this offering of Notes or the offering of the Existing Senior Secured Notes. By its nature, some or all of the HOT Proceeds Note Collateral will be illiquid and may have no readily ascertainable market value. In addition, certain Liens over the HOT Proceeds Note Collateral may not be enforced without the prior consent of the Israeli Ministry of Communications. Accordingly, the HOT Proceeds Note Collateral may not be able to be sold in a short period of time, or at all. In addition, the Intercreditor Agreement places limitations on the ability of the Security Agent to release the security interests in some of the HOT Proceeds Note Collateral, by reference to the interests of other creditors. These limitations may include requirements that some or all of the HOT Proceeds Note Collateral be disposed of only pursuant to public auctions or only at a price confirmed by a valuation. See "*Description of Other Indebtedness—The Intercreditor Agreement*" and "*Risk Factors—Risks Relating to the New Notes and the Structure—The value of the Collateral may not be sufficient to satisfy our obligations under the New Notes and such Collateral may be reduced or diluted under certain circumstances, which may be time consuming and cumbersome and certain Collateral and Guarantees will be limited to a specified maximum amount*".

Security Documents

Under the HOT Security Documents, the HOT Proceeds Note Obligor will grant security over the HOT Proceeds Note Collateral to secure the payment when due of HOT's and the HOT Proceeds Note Guarantors' payment obligations under the HOT Proceeds Note and the HOT Proceeds Note Guarantees. The HOT Security Documents will be entered into by the relevant security provider and the Security Agent as agent for the secured parties referred to therein.

The HOT Proceeds Note provides and the Indenture provides that, subject to the terms thereof and of the HOT Security Documents and the Intercreditor Agreement, the HOT Proceeds Note and the HOT Proceeds Note Guarantees, as applicable, will be secured by the security interest in the HOT Proceeds Note Collateral that is created by the HOT Security Documents and secures obligations under the HOT Proceeds Note or the HOT Proceeds Note Guarantees (the "*HOT Proceeds Note Security Interest*"). Such HOT Proceeds Note Security Interests in the HOT Proceeds Note Collateral may also secure certain other Indebtedness permitted by the Indenture and the HOT Proceeds Note to be incurred in the future and secured by the HOT Proceeds Note Collateral. However, the HOT Proceeds Note Security Interests may be released under certain circumstances as provided under "*Release of HOT Proceeds Note Collateral*" below. See "*Risk Factors—Risks Relating to the New Notes and the Structure—There are circumstances other than repayment or discharge of the New Notes under which the Collateral and the Guarantees will be released automatically, without your consent or the consent of the Trustee*".

Release of HOT Proceeds Note Collateral

The HOT Proceeds Note Obligor will be entitled to release the HOT Proceeds Note Security Interests in respect of the HOT Proceeds Note Collateral under any one or more of the following circumstances:

- (1) in connection with any sale or other disposition of the HOT Proceeds Note Collateral to a Person that is not HOT or a Restricted Subsidiary of HOT or, to the extent after such sale or other disposition such assets are pledged to secure the obligations under the Notes, the Note Guarantees and the Indenture, Altice International or any Restricted Subsidiary of Altice International (but excluding any transaction subject to "*Certain Covenants—Merger and Consolidation*"), if such sale or other disposition does not violate the covenant

described under “—*Certain Covenants—Limitation on Sales of Assets and Subsidiary Stock*”, but only in respect of the HOT Proceeds Note Collateral sold or otherwise disposed of;

- (2) in connection with the release of a HOT Proceeds Note Guarantor from its HOT Proceeds Note Guarantee pursuant to the terms of the HOT Proceeds Note, the release of the property and assets, and Capital Stock, of such HOT Proceeds Note Guarantor;
- (3) if the Issuer designates any Restricted Subsidiary of HOT to be an Unrestricted Subsidiary in accordance with the applicable provisions of the Indenture, the release of the property, assets and Capital Stock of such Unrestricted Subsidiary;
- (4) upon legal defeasance, covenant defeasance or satisfaction and discharge of the Indenture, as provided in “—*Defeasance*” and “—*Satisfaction and Discharge*”;
- (5) as described under “—*Amendments and Waivers*”, “—*Certain Covenants—Impairment of Security Interests*” and the second paragraph under “—*Certain Covenants—Limitation on Liens*”;
- (6) upon the full and final payment and performance of all obligations of HOT under the HOT Proceeds Note;
- (7) to release and re-take any Lien on any HOT Proceeds Note Collateral to the extent not otherwise prohibited by the terms of the HOT Proceeds Note and the HOT Security Documents;
- (8) in connection with a transaction permitted by the covenant described below under the caption “—*Certain Covenants—Merger and Consolidation*”; or
- (9) with the consent of holders of at least 75% in aggregate principal amount of Notes (including, without limitation, consent obtained in connection with a tender offer or exchange offer for, or purchase of, the Notes);

In addition, all of the HOT Proceeds Note Collateral may be release in connection with the HOT Direct Obligation Event, described below under “—*Direct Obligation Events*”.

Direct Obligation Events

Altice International may at any time elect to cause the HOT Proceeds Note Obligors to become direct Guarantors of the Notes by causing each of them to execute and deliver a supplemental indenture in the form attached to the Indenture pursuant to which HOT and each HOT Proceeds Note Guarantor will provide a Note Guarantee on a senior basis in an amount equal to or greater than the HOT Proceeds Note and the Guarantees thereof as of the date of such HOT Direct Obligation Event. Concurrently with the granting of such Note Guarantee, HOT and each HOT Proceeds Note Guarantor will grant an equivalent Lien over all of its assets that constitute HOT Proceeds Note Collateral on such date. In connection therewith, the HOT Proceeds Note Guarantees and the HOT Proceeds Note Collateral will be released, *provided* that no Default or Event of Default is outstanding or would result from any of the foregoing (collectively, the “*HOT Direct Obligation Event*”).

Altice International may at any time elect to cause OMT NewCo and its Subsidiaries that are obligors or guarantors under an OMT Proceeds Loan (the “*OMT Proceeds Loan Guarantors*”, together with OMT NewCo, the “*OMT Proceeds Loan Obligors*”) to become direct Guarantors of the Notes by causing each of them to execute and deliver a supplemental indenture in the form attached to the Indenture pursuant to which each OMT Proceeds Loan Obligor will provide a Note Guarantee on a senior basis in an amount equal to or greater than the applicable OMT Proceeds Loan and the Guarantees thereof (if any) as of the date of such OMT Direct Obligation Event. Concurrently with the granting of such Note Guarantee, such OMT Proceeds Loan Obligor will grant an equivalent Lien over all of its assets that constitute OMT Proceeds Loans Collateral on such date. In connection therewith, the applicable OMT Proceeds Loan Guarantees and the applicable OMT Proceeds Loans Collateral will be released, *provided* that no Default or Event of Default is outstanding or would result from any of the foregoing (collectively, the “*OMT Direct Obligation Event*”).

Intercreditor Agreement

To establish the relative rights of certain creditors of the Group under its financing arrangements, including, without limitation, the lenders under the Revolving Credit Facilities, the lenders under the Guarantee Facility, the lenders under the Senior Credit Facilities, the counterparties under certain Hedging Obligations secured on the Notes Collateral, the trustee and the holders of notes under the indenture governing the Existing Senior Secured Notes and the trustee and the holders of notes under the indenture governing the Existing Senior Notes, Altice International and the Guarantors, the agents under the Revolving Credit Facilities, the agent under the Guarantee Facility, the agents under the Senior Credit

Facilities, the trustee under the indenture governing the Existing Senior Secured Notes, the trustee under the indenture governing the Existing Senior Notes, and certain hedging counterparties and the Security Agent entered into or acceded to the Intercreditor Agreement. Please see “*Description of Other Indebtedness—Intercreditor Agreement*”. Upon release of the proceeds of the Notes and the New Senior Notes from escrow, the Trustee and the New Senior Notes Trustee will become party to the Intercreditor Agreement. Pursuant to the terms of the Intercreditor Agreement, any liabilities in respect of obligations under the Revolving Credit Facilities (other than the New Pari Passu Revolving Credit Facility) and certain Hedging Obligations that are permitted to be secured on the Notes Collateral (see “*Certain Definitions—Permitted Collateral Liens*”) will receive priority over amounts received from the sale of the Notes Collateral pursuant to an enforcement sale or other distressed disposal of such Notes Collateral pursuant to the Intercreditor Agreement. Any proceeds received upon any enforcement over any Notes Collateral, after all obligations under the Revolving Credit Facilities (other than the New Pari Passu Revolving Credit Facility) have been repaid and such Hedging Obligations have been discharged from such recoveries, will be applied pro rata in repayment of all obligations under the Indenture, the Notes, the Existing Senior Secured Notes, the Senior Credit Facilities, the Guarantee Facility, and the New Pari Passu Revolving Credit Facility and any other Indebtedness of the Issuer and the Guarantors permitted to be incurred and secured by the Note Collateral on a senior basis pursuant to the Indenture and the Intercreditor Agreement.

Subject to the Security Interest becoming enforceable, the Holders of the Notes (together with any other holders of senior secured indebtedness of the Issuer and the Guarantors that is not Super Priority Indebtedness) and the holders of Super Priority Indebtedness, in each case acting through their respective agent or trustee, are entitled to instruct the Security Agent on enforcement of the Notes Collateral. In the event either group of creditors issues conflicting enforcement instructions, subject to certain exceptions, a 30-day consultation period is required. In the event both creditor groups do not agree on the manner of enforcement after the consultation period, the Intercreditor Agreement provides that the Security Agent will act on the instructions of an “instructing group” consisting of a majority of the aggregate principal amount of the Notes and all other senior secured indebtedness (except Super Priority Indebtedness) of the Issuer and the Guarantors then outstanding. If all Super Priority Indebtedness is not repaid within six months after date on which either creditor group issues proposed enforcement instructions or the Security Agent has not commenced any enforcement action within three months of such date, thereafter instructions of the majority holders of Super Priority Indebtedness will prevail. See “*Description of Other Indebtedness—The Intercreditor Agreement*”.

The Indenture also provides that each holder, by accepting a Note, shall be deemed to have agreed to and accepted the terms and conditions of the Intercreditor Agreement and any Additional Intercreditor Agreement (whether then entered into or entered into in the future pursuant to the provisions described herein).

Additional Intercreditor Agreements; Agreement to Be Bound

Similar provisions to those described above may be included in any Additional Intercreditor Agreement (as defined below) entered into in compliance with the covenant described under “*—Certain Covenants—Additional Intercreditor Agreements*”.

The Indenture provides that each Holder, by accepting a Note, shall be deemed to have agreed to and accepted the terms and conditions of the Intercreditor Agreement and any Additional Intercreditor Agreement and to have authorized the Trustee and the Security Agent to enter into any such Intercreditor Agreement or any such Additional Intercreditor Agreement.

Restricted Subsidiaries and Unrestricted Subsidiaries

As of the Issue Date, all of Altice International’s Subsidiaries were Restricted Subsidiaries other than Holdco, Green Datacenter and Auberimmo SAS. However, in the circumstances described below under “*—Certain Definitions—Unrestricted Subsidiary*”, Altice International will be permitted to designate Restricted Subsidiaries as Unrestricted Subsidiaries. Unrestricted Subsidiaries will not be subject to many of the restrictive covenants in the Indenture.

Escrow of Proceeds; Special Mandatory Redemption

Concurrently with the closing of the offering of the Notes on the Issue Date, the Issuer entered into the Notes Escrow Agreement with the Trustee and the Escrow Agent, pursuant to which the initial purchasers deposited with the Escrow Agent an amount equal to the gross proceeds of this offering of the Notes into the Escrow Accounts. The initial funds deposited in the Escrow Accounts, and all other funds, securities, interest, dividends, distributions and other property and payments credited to the Escrow Accounts (less any property and/or funds paid in accordance with the Notes Escrow Agreement) are referred to, collectively, as the “*Escrowed Property*”. The Escrowed Property is controlled by the Escrow Agent, and pledged on a first ranking basis in favor of the Trustee on behalf of the holders of the Notes.

Pursuant to the Notes Escrow Agreement, the Issuer will be entitled to instruct the Escrow Agent to release some or all of the cash in the Escrow Accounts to invest such cash in certain permitted investments including in cash and/or any

highly-rated stable net asset value money market fund. The Notes Escrow Agreement requires that all proceeds of such investments be deposited back into the relevant Escrow Account when such investments are sold, liquidated or otherwise returned.

In order to cause the Escrow Agent to release any Escrowed Property to the Issuer for purposes of completing the PT Portugal Acquisition (any such release, the “*Release*”), the Escrow Agent and the Trustee shall have received from the Issuer, on or before the Escrow Longstop Date, an officer’s certificate, in the form attached to the Notes Escrow Agreement:

- (i) (A) the Acquisition Agreement shall not have been modified, amended or waived in any respect that is material and adverse to the holders of the Notes without the prior consent of the Holders of a majority of the outstanding Notes (it being understood and agreed that any increase or reduction in the purchase price shall not be deemed to be materially adverse to the Holders of the Notes; *provided* that any increase in the purchase price shall not be funded by indebtedness of Altice International or any of its subsidiaries (including the PT Portugal Group)); and (B) the Acquisition Agreement remains in full force and effect; and
- (ii) as of the Completion Date, there are no events of bankruptcy, insolvency or court protection with respect to the Issuer or Altice International;

provided that the release will occur promptly upon the satisfaction of the applicable conditions set forth above. Upon such release, the Escrowed Property will be paid out in accordance with the Notes Escrow Agreement and each Escrow Account will be reduced to zero.

In the event that (a) the Completion Date does not take place on or prior to the Escrow Longstop Date; (b) the Acquisition Agreement is terminated at any time prior to the Escrow Longstop Date; or (c) there is an event of bankruptcy, insolvency or court protection with respect to the Issuer on or prior to the Escrow Longstop Date (the date of any such event being the “*Special Termination Date*”), the Issuer will redeem all of the Notes (the “*Special Mandatory Redemption*”) at a price (the “*Special Mandatory Redemption Price*”) equal to 100% of the initial issue price of each Note, plus accrued but unpaid interest and Additional Amounts, if any, from the Issue Date to the Special Mandatory Redemption Date (as defined below and subject to the right of holders of record on the relevant record date to receive interest due on the relevant interest payment date).

Notice of the Special Mandatory Redemption will be delivered by the Issuer, no later than one Business Day following the Special Termination Date, to the Trustee and the Escrow Agent, and will provide that the Notes shall be redeemed on a date that is no later than the fifth Business Day after such notice is given by the Issuer in accordance with the terms of the Notes Escrow Agreement (the “*Special Mandatory Redemption Date*”). On or before the Special Mandatory Redemption Date, the Escrow Agent shall pay to the Principal Paying Agent for payment to each holder of Notes to be redeemed the Special Mandatory Redemption Price for such holder’s Notes, and concurrently with the payment to such holders, shall deliver any excess Escrowed Property (if any) to the Issuer.

On the Issue Date, Altice International entered into a guarantee agreement pursuant to which it guarantees the Issuer’s obligations under the Notes in the event the Special Mandatory Redemption Price payable upon any Special Mandatory Redemption Price exceeds the amount of the Escrowed Property.

To secure the payment of the Special Mandatory Redemption Price, the Trustee granted, for the benefits of the holders of the Notes, security interests in the Escrow Accounts and the rights of the Issuer under the Notes Escrow Agreement (the “*Escrow Assignments*”).

If at the time of the Special Mandatory Redemption, the Notes are listed on the Luxembourg Stock Exchange and the rules of the Luxembourg Stock Exchange so require, the Issuer will notify the Luxembourg Stock Exchange that the Special Mandatory Redemption has occurred and any relevant details relating to such special mandatory redemption.

Optional Redemption

Except as described below and except as described under “*Redemption for Changes in Withholding Taxes*” and “*Escrow of Proceeds; Special Mandatory Redemption*”, the Notes are not redeemable until February 15, 2018. On and after February 15, 2018 the Issuer may redeem all or, from time to time, part of the Dollar Notes and/or the Euro Notes upon not less than 30 nor more than 60 days’ notice, at the following redemption prices (expressed as a percentage of the principal amount) plus accrued and unpaid interest and Additional Amounts (as defined below), if any, to, but not including, the applicable redemption date (subject to the right of the Holders of record on the relevant record date to receive interest due on the relevant interest payment date), if redeemed during the twelve-month period beginning on February 15 of the years indicated below:

Year	Redemption Price	
	Dollar Notes	Euro Notes
2018	104.969%	103.938%
2019	103.313%	102.625%
2020	101.656%	101.313%
2021 and thereafter	100.000%	100.000%

Unless the Issuer defaults in the payment of the redemption price, interest will cease to accrue on the Notes or the portion thereof called for redemption on the applicable redemption date. Any such redemption and notice may, in the Issuer's discretion, be subject to the satisfaction of one or more conditions precedent.

Prior to February 15, 2018, the Issuer may on any one or more occasions redeem up to 40% of the original principal amount of the Dollar Notes and up to 40% of the original amount of the Euro Notes (including, in each case, the principal amount of any Additional Notes denominated in such currencies), upon not less than 30 nor more than 60 days' notice, with funds in an aggregate amount (the "Redemption Amount") not exceeding the Net Cash Proceeds of one or more Equity Offerings at a redemption price of 106.625% of the principal amount of the Dollar Notes and 105.250% of the principal amount of the Euro Notes, plus, in each case, accrued and unpaid interest and Additional Amounts, if any, to, but not including, the applicable redemption date (subject to the right of Holders of record on the relevant record date to receive interest due on the relevant interest payment date); *provided* that:

- (1) at least 60% of the original principal amount of each of the Dollar Notes (including the principal amount of any Additional Notes denominated in U.S dollars) and the Euro Notes (including the principal amount of any Additional Notes denominated in euro) remains outstanding after each such redemption; and
- (2) the redemption occurs within 180 days after the closing of such Equity Offering.

Any redemption notice given in respect of the redemption referred to in the preceding paragraph may be given prior to completion of the related Equity Offering, and any such redemption or notice may, at the Issuer's discretion, be subject to the satisfaction of one or more conditions precedent, including the completion of the related Equity Offering.

In addition, prior to February 15, 2018, the Issuer may redeem all or, from time to time, a part of the Dollar Notes and/or the Euro Notes upon not less than 30 nor more than 60 days' notice at a redemption price equal to 100% of the principal amount thereof plus the Applicable Premium and accrued and unpaid interest and Additional Amounts, if any, to, but not including, the applicable redemption date (subject to the right of Holders of record on the relevant record date to receive interest due on the relevant interest payment date). Any such redemption and notice may, at the Issuer's discretion, be subject to the satisfaction of one or more conditions precedent.

If the Issuer effects an optional redemption of Notes, it will, for so long as the Notes are listed on the Euro MTF Market of the Luxembourg Stock Exchange and the rules of the Luxembourg Stock Exchange so require, inform the Luxembourg Stock Exchange of such optional redemption and confirm the aggregate principal amount of the Notes that will remain outstanding immediately after such redemption.

Sinking Fund

Except as described under "*Escrow of Proceeds; Special Mandatory Redemption*", the Issuer will not be required to make mandatory redemption payments or sinking fund payments with respect to the Notes.

Selection and Notice

If less than all of the Notes are to be redeemed at any time, the Notes for redemption will be selected in accordance with the procedures of DTC, Euroclear and/or Clearstream, as applicable, or if DTC, Euroclear and/or Clearstream, as applicable, prescribe no method of selection, then the Issuer will instruct the Trustee or the Registrar to select the Notes for redemption in compliance with the requirements of the principal securities exchange, if any, on which the Notes are listed, as certified to the Trustee or the Registrar or if the Notes are not so listed or such exchange prescribes no method of selection, then based on a method that most nearly approximates a *pro rata* selection or by lot; *provided, however*, that no Dollar Note of \$200,000 in aggregate principal amount or less shall be redeemed in part and only Dollar Notes in integral multiples of \$1,000 will be redeemed and no Euro Note of €100,000 in aggregate principal amount or less shall be redeemed in part and only Euro Notes in integral multiples of €1,000 will be redeemed. Neither the Trustee nor the Registrar will be liable for any selections made by it or DTC in accordance with this paragraph.

For so long as the Notes are listed on the Euro MTF Market of the Luxembourg Stock Exchange, not less than 30 nor more than 60 days prior to the redemption date, the Issuer will (if such Notes are in certificated form) mail notice of redemption to Holders by first-class mail, postage prepaid, at their respective addresses as they appear on the registration

books of the Registrar. If such Notes are in global form, notice of redemption will be delivered to DTC (in the case of Dollar Notes) and Euroclear and Clearstream (in the case of Euro Notes) for communication to the entitled account holder. Such notice of redemption may also be posted on the official website of the Luxembourg Stock Exchange (www.bourse.lu), to the extent and in the manner permitted by the rules of the Luxembourg Stock Exchange.

If any Note is to be redeemed in part only, the notice of redemption that relates to that Note shall state the portion of the principal amount thereof to be redeemed. In the case of a Definitive Registered Note, a new Definitive Registered Note in principal amount equal to the unredeemed portion of any Definitive Registered Note redeemed in part will be issued in the name of the Holder thereof upon cancellation of the original Definitive Registered Note. In the case of a Global Note, an appropriate notation will be made on such Note to decrease the principal amount thereof to an amount equal to the unredeemed portion thereof. Subject to the terms of the applicable redemption notice, Notes called for redemption become due on the date fixed for redemption. On and after the redemption date, interest ceases to accrue on Notes or portions of Notes called for redemption.

Redemption for Changes in Withholding Taxes

The Issuer may redeem the Notes, in whole but not in part, at its discretion at any time upon giving not less than 30 nor more than 60 days' prior notice to the holders of the Notes (which notice will be irrevocable and given in accordance with the procedures described in "—Selection and Notice"), at a redemption price equal to 100% of the aggregate principal amount thereof, together with accrued and unpaid interest, if any, to the date fixed by the Issuer for redemption (a "Tax Redemption Date") and all Additional Amounts (if any) then due and which will become due on the Tax Redemption Date as a result of the redemption or otherwise (subject to the right of holders of the Notes on the relevant record date to receive interest due on the relevant interest payment date and Additional Amounts (if any) in respect thereof), if on the next date on which any amount would be payable in respect of the Notes, the Issuer or any Guarantor is or would be required to pay Additional Amounts, and (a) the Issuer or the relevant Guarantor cannot avoid such requirement by taking reasonable measures available to it (including the designation of a different Paying Agent), (b) in the case of a Guarantor, such amounts cannot be paid by the Issuer or any other Guarantor who in turn can pay such amounts without the obligation to pay Additional Amounts and (c) the requirement arises as a result of:

- (1) any amendment to, or change in, the laws or treaties (or any regulations or rulings promulgated thereunder) of a relevant Tax Jurisdiction (as defined in "—Withholding Taxes" below) which change or amendment is announced and becomes effective on or after the Issue Date (or, if the applicable Tax Jurisdiction became a Tax Jurisdiction on a date after the Issue Date, such later date); or
- (2) any amendment to, or change in, an official written interpretation or application of such laws, treaties, regulations or rulings (including by virtue of a holding, judgment or order by a court of competent jurisdiction or a change in published administrative practice) which amendment or change is announced and becomes effective on or after the Issue Date (or, if the applicable Tax Jurisdiction became a Tax Jurisdiction on a date after the Issue Date, such later date).

The Issuer will not give any such notice of redemption earlier than 60 days prior to the earliest date on which the Issuer or the relevant Guarantor would be obligated to make such payment or withholding if a payment in respect of the Notes was then due, and the obligation to pay Additional Amounts must be in effect at the time such notice is given. Prior to the publication or, where relevant, mailing of any notice of redemption of the Notes pursuant to the foregoing, the Issuer will deliver to the Trustee an opinion of independent tax counsel to the effect that there has been such amendment or change which would entitle the Issuer to redeem the Notes hereunder. In addition, before the Issuer publishes or mails notice of redemption of the Notes as described above, it will deliver to the Trustee an Officer's Certificate to the effect that (a) it or the relevant Guarantor cannot avoid its obligation to pay Additional Amounts by the Issuer or the relevant Guarantor taking reasonable measures available to it and (b) in the case of a Guarantor, the amounts giving rise to such obligation cannot be paid by the Issuer or any other Guarantor without the obligation to pay Additional Amounts.

The Trustee will accept and shall be entitled to conclusively rely without further inquiry on such Officer's Certificate and opinion of counsel as sufficient evidence of the existence and satisfaction of the conditions precedent as described above, in which event it will be conclusive and binding on the holders of the Notes.

For the avoidance of doubt, the implementation of European Council Directive 2003/48/EC or any other directive implementing the conclusions of the ECOFIN Council meeting of 26 and 27 November 2000 on the taxation of savings income or any law implementing or complying with or introduced in order to conform to, such directive will not be a change or amendment for such purposes.

The foregoing will apply *mutatis mutandis* to any jurisdiction in which any successor Person to the Issuer is incorporated or organized, engaged in business or resident for tax purposes or any jurisdiction from or through which payment is made by or on behalf of such Person on the Notes and any political subdivision thereof or therein.

Withholding Taxes

All payments made under or with respect to the Notes or any Note Guarantee will be made free and clear of and without withholding or deduction for, or on account of, any present or future tax, duty, levy, assessment or other governmental charge, including any related interest, penalties or additions to tax (“Taxes”) unless the withholding or deduction of such Taxes is then required by law or by the official interpretation or administration thereof. If any deduction or withholding for, or on account of, any Taxes imposed or levied by or on behalf of (1) any jurisdiction in which the Issuer or any Guarantor is then incorporated or organized, engaged in business for tax purposes or resident for tax purposes or any political subdivision or governmental authority thereof or therein having power to tax or (2) any jurisdiction from or through which payment is made by or on behalf of the Issuer or any Guarantor (including, without limitation, the jurisdiction of any paying agent for the Notes) or any political subdivision thereof or therein (each, a “Tax Jurisdiction”) will at any time be required to be made from any payments made under or with respect to the Notes or any Note Guarantee, including, without limitation, payments of principal, redemption price, interest or premium, the Issuer or the relevant Guarantor, as applicable, will pay such additional amounts (the “Additional Amounts”) as may be necessary in order that the net amounts received in respect of such payments by each holder of the Notes after such withholding or deduction (including any such withholding or deduction from such Additional Amounts) will equal the respective amounts that would have been received in respect of such payments in the absence of such withholding or deduction; *provided, however*, that no Additional Amounts will be payable with respect to:

- (1) any Taxes, to the extent such Taxes would not have been imposed but for the existence of any actual or deemed present or former connection between the holder (or between a fiduciary, settler, beneficiary, member or shareholder of, or possessor of a power over the relevant holder, if the relevant holder is an estate, nominee, trust, partnership, limited liability company or corporation) or the beneficial owner of the Notes and the relevant Tax Jurisdiction (including, without limitation, being or having been a citizen, resident, or national thereof or being or having been present or engaged in a trade or business therein or having or having had a permanent establishment therein), other than connections arising from the holding of such Note or any Note Guarantee, the enforcement of rights under such Note or under a Note Guarantee or the receipt of any payments in respect of such Note or a Note Guarantee;
- (2) any Taxes, to the extent such Taxes were imposed as a result of the presentation of a Note for payment (where Notes are in the form of Definitive Registered Notes and presentation is required) more than 30 days after the relevant payment is first made available for payment to the holder (except to the extent that the holder would have been entitled to Additional Amounts had the Note been presented on the last day of such 30 day period);
- (3) any estate, inheritance, gift, sales, transfer, personal property or similar Taxes or any excise Taxes imposed on transfers;
- (4) any Taxes withheld, deducted or imposed on a payment to an individual that are required to be made pursuant to European Council Directive 2003/48/EC or any other directive implementing the conclusions of the ECOFIN Council meeting of November 26 and 27, 2000 on the taxation of savings income, or any law implementing or complying with or introduced in order to conform to, such directive;
- (5) Taxes imposed on or with respect to a payment made to a holder or beneficial owner of Notes who would have been able to avoid such withholding or deduction by presenting the relevant Note to another Paying Agent in a member state of the European Union;
- (6) any Taxes payable other than by deduction or withholding from payments under, or with respect to, the Notes or with respect to any Note Guarantee;
- (7) any Taxes to the extent such Taxes are imposed or withheld by reason of the failure of the holder or beneficial owner of Notes to comply with any reasonable written request of the Issuer addressed to the holder or beneficial owner and made at least 60 days before any such withholding or deduction would be payable to satisfy any certification, identification, information or other reporting requirements, whether required by statute, treaty, regulation or administrative practice of the relevant Tax Jurisdiction, as a precondition to exemption from, or reduction in the rate of deduction or withholding of, Taxes imposed by such Tax Jurisdiction (including, without limitation, a certification that the holder or beneficial owner is not resident in the Tax Jurisdiction), but in each case, only to the extent the holder or beneficial owner is legally eligible to provide such certification or documentation;
- (8) all United States federal backup withholding taxes;
- (9) any Taxes that are imposed or withheld pursuant to Sections 1471 through 1474 of the U.S. Internal Revenue Code of 1986, as amended (the “Code”), as of the Issue Date (or any amended or successor version of such

sections), any regulations promulgated thereunder, any official interpretations thereof, any similar law or regulation adopted pursuant to an intergovernmental agreement between a non-U.S. jurisdiction and the United States with respect to the foregoing or any agreements entered into pursuant to section 1471(b)(1) of the Code; or

(10) any combination of items (1) through (9) above.

Such Additional Amounts will also not be payable where, had the beneficial owner of the Note been the holder of the Note, it would not have been entitled to payment of Additional Amounts by reason of any of clauses (1) to (10) inclusive above.

In addition to the foregoing, the Issuer and the Guarantors, as the case may be, will also pay and indemnify the holder for any present or future stamp, issue, registration, court or documentary Taxes, or any other excise or property Taxes, charges or similar levies (including penalties, interest and any other reasonable expenses related thereto) which are levied by any Tax Jurisdiction on the execution, delivery, issuance, or registration of any of the Notes, the Indenture, any Note Guarantee or any other document or instrument referred to therein, or the receipt of any payments with respect thereto, or the enforcement of, any of the Notes or any Note Guarantee (limited, solely in the case of taxes attributable to the receipt of any payments with respect thereto, to any such taxes imposed in a Tax Jurisdiction that are not excluded under clauses (1) through (5) or (7) through (9) above).

If the Issuer or any Guarantor, as the case may be, becomes aware that it will be obligated to pay Additional Amounts with respect to any payment under or with respect to the Notes or any Note Guarantee, each of the Issuer or the relevant Guarantor, as the case may be, will deliver to the Trustee on a date that is at least 30 days prior to the date of that payment (unless the obligation to pay Additional Amounts arises less than 30 days prior to that payment date, in which case the Issuer or the relevant Guarantor shall notify the Trustee promptly thereafter) an Officer's Certificate stating the fact that Additional Amounts will be payable and the amount estimated to be so payable. The Officer's Certificate must also set forth any other information reasonably necessary to enable the Paying Agents to pay such Additional Amounts to holders on the relevant payment date. The Trustee shall be entitled to rely solely on such Officer's Certificate as conclusive proof that such payments are necessary.

The Issuer or the relevant Guarantor will make all withholdings and deductions required by law and will remit the full amount deducted or withheld to the relevant Tax authority in accordance with applicable law. The Issuer or the relevant Guarantor will use its reasonable efforts to obtain Tax receipts from each Tax authority evidencing the payment of any Taxes so deducted or withheld. The Issuer or the relevant Guarantor will furnish to the Trustee (or to a holder or beneficial owner upon written request), within a reasonable time after the date the payment of any Taxes so deducted or withheld is made, certified copies of Tax receipts evidencing payment by the Issuer or a Guarantor, as the case may be, or if, notwithstanding such entity's efforts to obtain receipts, receipts are not obtained, other evidence of payments (reasonably satisfactory to the Trustee) by such entity. Upon reasonable request, copies of Tax receipts or other evidence of payments, as the case may be, will be made available by the Trustee to the holders or beneficial owners of the Notes.

Whenever in the Indenture or in this "Description of Senior Secured Notes" there is mentioned, in any context, the payment of amounts based upon the principal amount of the Notes or of principal, interest or of any other amount payable under, or with respect to, any of the Notes or any Note Guarantee, such mention shall be deemed to include mention of the payment of Additional Amounts to the extent that, in such context, Additional Amounts are, were or would be payable in respect thereof.

The above obligations will survive any termination, defeasance or discharge of the Indenture, and any transfer by a holder or beneficial owner of its Notes, and will apply, *mutatis mutandis*, to any jurisdiction in which any successor Person to the Issuer or any Guarantor is incorporated or organized, engaged in business for tax purposes or resident for tax purposes (and any political subdivision or governmental authority thereof or therein having power to tax) and any jurisdiction from or through which payment is made by or on behalf of such Person on the Notes or any Note Guarantee and any political subdivision thereof or therein.

Change of Control

If a Change of Control Triggering Event occurs, subject to the terms of the covenant described under this heading "Change of Control", each Holder will have the right to require the Issuer to repurchase all or any part (equal to \$200,000 or an integral multiple of \$1,000 in excess thereof, in the case of Dollar Notes, and €100,000 principal amount and integral multiples of €1,000 in excess thereof, in the case of Euro Notes) of such Holder's Notes at a purchase price in cash equal to 101% of the principal amount of the Notes, plus accrued and unpaid interest and Additional Amounts, if any, to the date of purchase (subject to the right of Holders of record on the relevant record date to receive interest due on the relevant interest payment date); *provided, however*, that the Issuer shall not be obliged to repurchase Notes as described under this heading, "Change of Control", in the event and to the extent that it has unconditionally exercised its

right to redeem all of the Notes as described under “—*Optional Redemption*” or all conditions to such redemption have been satisfied or waived. No such purchase in part shall reduce the principal amount at maturity of the Dollar Notes held by any holder to below \$200,000 or the Euro Notes held by any holder to below €100,000.

Unless the Issuer has unconditionally exercised its right to redeem all the Notes as described under “—*Optional Redemption*” or all conditions to such redemption have been satisfied or waived, no later than the date that is 60 days after any Change of Control Triggering Event or, at the Issuer’s option, at any time prior to a Change of Control Triggering Event following the public announcement thereof or if a definitive agreement is in place for the Change of Control, the Issuer will send a notice (the “Change of Control Offer”) to each Holder of any such Notes by mail or otherwise in accordance with the procedures set forth in the Indenture, with a copy to the Trustee:

- (1) stating that a Change of Control Triggering Event has occurred or may occur and that such Holder has the right to require the Issuer to purchase all or any part of such Holder’s Notes at a purchase price in cash equal to 101% of the principal amount of such Notes plus accrued and unpaid interest and Additional Amounts, if any, to, but not including, the date of purchase (subject to the right of Holders of record on a record date to receive interest on the relevant interest payment date) (the “Change of Control Payment”);
- (2) stating the repurchase date (which shall be no earlier than 30 days nor later than 60 days from the date such notice is mailed) (the “Change of Control Payment Date”) and the record date;
- (3) stating that any Note accepted for payment pursuant to the Change of Control Offer will cease to accrue interest after the Change of Control Payment Date unless the Change of Control Payment is not paid, and that any Notes or part thereof not tendered will continue to accrue interest;
- (4) describing the circumstances and relevant facts regarding the transaction or transactions that constitute the Change of Control Triggering Event;
- (5) describing the procedures determined by the Issuer, consistent with the Indenture, that a Holder must follow in order to have its Notes repurchased;
- (6) if such notice is mailed prior to the occurrence of a Change of Control Triggering Event, stating that the Change of Control Offer is conditional on the occurrence of such Change of Control Triggering Event; and
- (7) certain other procedures that a holder of Notes must follow to accept a Change of Control Offer or to withdraw such acceptance.

The Issuer shall cause to be published the notice described above in a leading newspaper having a general circulation in London (which is expected to be the *Financial Times*) or through the newswire service of Bloomberg (or if Bloomberg does not then operate, any similar agency). In addition, if and for so long as the Notes are listed on the Official List of the Luxembourg Stock Exchange and admitted for trading on the Euro MTF Market and the rules of the Luxembourg Stock Exchange so require, the Issuer will publish a public announcement with respect to the results of any Change of Control Offer in a leading newspaper of general circulation in Luxembourg (which is expected to be the *Luxemburger Wort*) or, to the extent and in the manner permitted by such rules, post such notice on the official website of the Luxembourg Stock Exchange. The ability of the Issuer to repurchase Notes pursuant to a Change of Control Offer may be limited by a number of factors. See “*Risk Factors—Risks Relating to the New Notes and the Structure—We may not be able to obtain enough funds necessary to finance an offer to repurchase the New Notes upon the occurrence of certain events constituting a change of control triggering event (as defined in the New Indentures) as required by the New Indentures*”.

On the Change of Control Payment Date, if the Change of Control Triggering Event shall have occurred, the Issuer will, to the extent lawful:

- (1) accept for payment all Notes or portion thereof properly tendered pursuant to the Change of Control Offer;
- (2) deposit with the Paying Agent an amount equal to the Change of Control Payment in respect of all Notes so tendered;
- (3) deliver or cause to be delivered to the Trustee an Officer’s Certificate stating the aggregate principal amount of Notes or portions of the Notes being purchased by the Issuer in the Change of Control Offer;
- (4) in the case of Global Notes, deliver, or cause to be delivered, to the Principal Paying Agent (in the case of Euro Notes) and the U.S. Paying Agent (in the case of Dollar Notes) the applicable Global Notes in order to reflect thereon the portion of such Notes or portions thereof that have been tendered to and purchased by the Issuer; and

- (5) in the case of Definitive Registered Notes, deliver, or cause to be delivered, to the relevant Registrar for cancellation all Definitive Registered Notes accepted for purchase by the Issuer.

If any Definitive Registered Notes have been issued, the Paying Agent, at the Issuer's expense, will promptly mail to each Holder of Definitive Registered Notes so tendered the Change of Control Payment for such Notes, and the Trustee will promptly instruct its authenticating agent to authenticate and, at the Issuer's expense, mail (or cause to be transferred by book-entry) to each Holder of Definitive Registered Notes a new Definitive Registered Note equal in principal amount to the unpurchased portion of the Notes surrendered, if any; provided that each such new Note will be in a principal amount that is at least \$200,000 and integral multiples of \$1,000 in excess thereof, in the case of Dollar Notes, and € 100,000 principal amount and integral multiples of €1,000 in excess thereof, in the case of Euro Notes.

For so long as the Notes are listed on the Euro MTF Market of the Luxembourg Stock Exchange and the rules of such exchange so require, the Issuer will publish a notice with respect to the results of the Change of Control Offer as soon as reasonably practicable after the Change of Control Payment Date on the official website of the Luxembourg Stock Exchange (www.bourse.lu).

The Change of Control provisions described above will be applicable whether or not any other provisions of the Indenture are applicable. Except as described above with respect to a Change of Control Triggering Event, the Indenture does not contain provisions that permit the Holders to require that the Issuer repurchase or redeem the Notes in the event of a takeover, recapitalization or similar transaction. The existence of a Holder's right to require the Issuer to repurchase such Holder's Notes upon the occurrence of a Change of Control Triggering Event may deter a third party from seeking to acquire Altice International or its Subsidiaries in a transaction that would constitute a Change of Control Triggering Event.

The Issuer will not be required to make a Change of Control Offer upon a Change of Control Triggering Event if a third party makes the Change of Control Offer in the manner, at the times and otherwise in compliance with the requirements set forth in the Indenture applicable to a Change of Control Offer made by the Issuer and purchases all Notes validly tendered and not withdrawn under such Change of Control Offer. Notwithstanding anything to the contrary herein, a Change of Control Offer may be made in advance of a Change of Control Triggering Event, conditional upon such Change of Control Triggering Event, if a definitive agreement is in place for the Change of Control at the time of making of the Change of Control Offer.

If Holders of not less than 90% in aggregate principal amount of the outstanding Notes of a series validly tender and do not withdraw such Notes in a Change of Control Offer and the Issuer, or any third party making a Change of Control Offer in lieu of the Issuer as described above, purchases all of the Notes of such series validly tendered and not withdrawn by such Holders, the Issuer or such third party will have the right, upon not less than 10 nor more than 60 days' prior notice, given not more than 30 days following such purchase pursuant to the Change of Control Offer described above, to redeem all Notes of such series that remain outstanding following such purchase at a price in cash equal to 101% of the principal amount thereof plus accrued and unpaid interest to but excluding the date of the delivery of the notice for such redemption.

The provisions of the Indenture do not afford holders of the Notes the right to require the Issuer to repurchase the Notes in the event of a highly leveraged transaction, certain transactions with Altice International's management or its Affiliates or certain other sale transactions, including a reorganization, restructuring, merger or similar transaction (including, in certain circumstances, an acquisition of Altice International by management or its Affiliates) involving the Issuer that may adversely affect holders of the Notes, if such transaction is not a transaction defined as a Change of Control Triggering Event.

The Issuer will comply, to the extent applicable, with the requirements of Section 14(e) of the Exchange Act and any other securities laws or regulations in connection with the repurchase of Notes pursuant to this covenant. To the extent that the provisions of any securities laws or regulations conflict with provisions of the Indenture, the Issuer will comply with the applicable securities laws and regulations and will not be deemed to have breached its obligations under the Change of Control provisions of the Indenture by virtue of the conflict.

The Issuer's ability to repurchase Notes issued by it pursuant to a Change of Control Offer may be limited by a number of factors. The existing indebtedness of the Issuer, Altice International or the Restricted Subsidiaries contains, and its respective future indebtedness may also contain, prohibitions of certain events that would constitute a "change of control" or require such Indebtedness to be repurchased or repaid upon such a change of control. Moreover, the exercise by the Holders of their right to require the Issuer to repurchase the Notes could cause a default under, or require a repurchase of, such Indebtedness, even if the Change of Control Triggering Event itself does not, due to the financial effect of such repurchase on the Issuer. Finally, the Issuer's ability to pay cash to the Holders upon a repurchase may be limited by Altice International's and its Restricted Subsidiaries' then existing financial resources. There can be no assurance that sufficient funds will be available when necessary to make any required repurchases. See "*Risk Factors*—

Risks Relating to the New Notes and the Structure—We may not be able to obtain enough funds necessary to finance an offer to repurchase the New Notes upon the occurrence of certain events constituting a change of control triggering event (as defined in the New Indentures) as required by the New Indentures”.

The definition of “Change of Control” includes a direct or indirect sale, lease, transfer, conveyance or other disposition of all or substantially all of the property and assets of Altice International and its Restricted Subsidiaries taken as a whole to a Person (including any “person” (as that term is used in Section 13(d)(3) of the Exchange Act)), other than a Permitted Holder. Although there is a limited body of case law interpreting the phrase “substantially all”, there is no precise established definition of the phrase “substantially all” under applicable law. Accordingly, in certain circumstances there may be a degree of uncertainty as to whether a particular transaction would involve a disposition of “all or substantially all” of the property or assets of a Person. As a result, it may be unclear as to whether a Change of Control has occurred and whether a Holder may require the Issuer to make an offer to repurchase the Notes as described above. However, subject to the conditions specified in sub-clause (3) of “*Certain Definitions—Change of Control*”, a Change of Control shall be deemed not to have occurred as a result of the sale, lease, transfer, conveyance or other disposition in one or a series of related transactions of any assets of Altice International and its Subsidiaries or the Target and its Subsidiaries (including the Capital Stock of the Target or any Subsidiary of Altice International or the Target) that is required pursuant to Competition Laws in relation to the Acquisition or is taken to avoid or eliminate any impediment under Competition Laws in relation to the Acquisition (including, without limitation, in response to any actions initiated by an administrative, regulatory or other governmental authority or private party under Competition Laws).

The provisions of the Indenture relating to the Issuer’s obligation to make an offer to repurchase the Notes as a result of a Change of Control Triggering Event may be waived or modified with the written consent of holders of a majority in outstanding principal amount of the Notes.

Offer to Repurchase with Minority Shareholder Option Proceeds

Pursuant to the Minority Shareholder Call Options granted under the Minority Shareholder Purchase Agreements, each Minority Shareholder is entitled to re-acquire all or a portion of the shares of HOT sold by it to Cool in connection with the Take-Private Transaction at an exercise price equal to NIS 48 per share (subject to customary anti-dilution rights and purchase price adjustments) during the two-year period commencing on December 27, 2013. Subject to certain limitations, each Minority Shareholder Call Option may be exercised in up to three transactions. See “*Description of our Business—HOT Minority Shareholder Agreements*”. The transfer of shares of Capital Stock of HOT upon any exercise of a Minority Shareholder Call Option will not be deemed to be an Asset Disposition under the Indenture. However, the Issuer will be required to offer to repurchase the Notes with the Net Cash Proceeds of such exercise as described below.

Any Net Cash Proceeds received by Altice International or any Restricted Subsidiary from any Minority Shareholder Option Exercise will constitute “Minority Shareholder Option Proceeds”. When the aggregate amount of Minority Shareholder Option Proceeds exceeds NIS 100 million (the “*Minority Shareholder Option Offer Threshold*”), the Issuer will be required within ten (10) Business Days to make an offer (a “*Minority Shareholder Option Proceeds Offer*”) to all holders of Notes and, to the extent the Issuer elects or the Issuer or a Guarantor is required by the terms of other outstanding Pari Passu Indebtedness, to all holders of such other outstanding Pari Passu Indebtedness to purchase the maximum principal amount of Notes and any such Pari Passu Indebtedness to which such Minority Shareholder Option Proceeds Offer applies that may be purchased out of the Applicable Minority Shareholder Option Proceeds Offer Amount, at an offer price in respect of the Notes in an amount equal to (and, in the case of any Pari Passu Indebtedness, an offer price of no more than) 103% of the principal amount of the Notes and 103% of the principal amount of Pari Passu Indebtedness, in each case, plus accrued and unpaid interest, if any, to, but not including, the date of purchase, in accordance with the procedures set forth in the Indenture or the agreements governing the Pari Passu Indebtedness, as applicable, and in the case of the Notes, in minimum denominations of \$200,000 and in integral multiples of \$1,000 in excess thereof, in the case of Dollar Notes, and €100,000 principal amount and integral multiples of €1,000 in excess thereof, in the case of Euro Notes, *provided* that the Minority Shareholder Option Offer Threshold shall not apply in the event that (i) at the time of receipt of such Minority Shareholder Option Proceeds, all Minority Shareholder Call Options have been exercised in full, (ii) all unexercised Minority Shareholder Call Options have expired pursuant to the terms of the relevant Minority Shareholder Purchaser Agreements or (iii) all unexercised Minority Shareholder Call Options have been terminated.

To the extent that the aggregate amount of Notes and Pari Passu Indebtedness so validly tendered and not properly withdrawn pursuant to a Minority Shareholder Option Proceeds Offer is less than the Minority Shareholder Option Proceeds, Altice International may use any remaining Minority Shareholder Option Proceeds for general corporate purposes, to the extent not prohibited by the other covenants contained in the Indenture. If the aggregate principal amount of the Notes surrendered in any Minority Shareholder Option Proceeds Offer by Holders and other Pari Passu Indebtedness surrendered by holders or lenders, collectively, exceeds the Minority Shareholder Option Proceeds, the Minority Shareholder Option Proceeds shall be allocated among the Notes and Pari Passu Indebtedness to be purchased on a *pro rata* basis on the basis of the aggregate principal amount of tendered Notes and Pari Passu Indebtedness. For the

purposes of calculating the principal amount of any such Indebtedness not denominated in euro, such Indebtedness shall be calculated by converting any such principal amounts into their Euro Equivalent determined as of a date selected by the Issuer that is within the Minority Shareholder Option Proceeds Offer Period (as defined below).

To the extent that any portion of Net Available Cash payable in respect of the relevant Notes is denominated in a currency other than the currency in which the Notes are denominated, the amount thereof payable in respect of such Notes shall not exceed the net amount of funds in the currency in which such Notes are denominated that is actually received by the Issuer upon converting such portion of the Net Available Cash into such currency.

The Minority Shareholder Option Proceeds Offer, in so far as it relates to the Notes, will remain open for a period of not less than 20 Business Days following its commencement (the “*Minority Shareholder Option Proceeds Offer Period*”). No later than five (5) Business Days after the termination of the Minority Shareholder Option Proceeds Offer Period (the “*Minority Shareholder Option Proceeds Purchase Date*”), the Issuer will purchase the principal amount of Notes and, to the extent it elects, Pari Passu Indebtedness required to be purchased by it pursuant to this covenant (the “*Minority Shareholder Option Offer Amount*”) or, if less than the Minority Shareholder Option Offer Amount has been so validly tendered, all Notes and Pari Passu Indebtedness validly tendered in response to the Minority Shareholder Option Proceeds Offer.

On or before the Minority Shareholder Option Proceeds Purchase Date, the Issuer will, to the extent lawful, accept for payment, on a *pro rata* basis to the extent necessary, the Minority Shareholder Option Offer Amount of Notes and Pari Passu Indebtedness or portions of Notes and Pari Passu Indebtedness so validly tendered and not properly withdrawn pursuant to the Minority Shareholder Option Proceeds Offer, or if less than the Minority Shareholder Option Offer Amount has been validly tendered and not properly withdrawn, all Notes and Pari Passu Indebtedness so validly tendered and not properly withdrawn and, in the case of the Notes, in minimum denominations of \$200,000 and integral multiples of \$1,000 in excess thereof, in the case of Dollar Notes, and €100,000 principal amount and integral multiples of €1,000 in excess thereof, in the case of Euro Notes. The Issuer will deliver to the Trustee an Officer’s Certificate stating that such Notes or portions thereof were accepted for payment by the Issuer in accordance with the terms of this covenant. The Issuer or the Paying Agent, as the case may be, will promptly (but in any case not later than five (5) Business Days after termination of the Minority Shareholder Option Proceeds Offer Period) mail or deliver to each tendering Holder of Notes an amount equal to the purchase price of the Notes so validly tendered and not properly withdrawn by such Holder, and accepted by the Issuer for purchase, and the Issuer will promptly issue a new Note and in the case of Definitive Registered Notes, deliver or cause to be delivered to the relevant Registrar for cancellation all Definitive Registered Notes accepted for purchase by the Issuer (or, in the case of Global Notes, cause the Paying Agent to reduce the aggregate principal amount of the applicable Global Note), and the Trustee, upon receipt of an Officer’s Certificate from the Issuer, will authenticate and mail or deliver (or cause to be transferred by book-entry) such new Note to such Holder, in a principal amount equal to any unpurchased portion of the Note surrendered; *provided* that each such new Note will be in a principal amount with a minimum denomination of \$200,000, in the case of Dollar Notes, and €100,000, in the case of Euro Notes. Any Note not so accepted will be promptly mailed or delivered (or transferred by book-entry) by the Issuer to the Holder thereof.

Certain Covenants

Limitation on Indebtedness

Altice International will not and will not permit any of its Restricted Subsidiaries to, Incur any Indebtedness (including Acquired Indebtedness); *provided, however*, that the Issuer may Incur Senior Secured Indebtedness if on the date on which such Senior Secured Indebtedness is Incurred, the Consolidated Net Senior Secured Leverage Ratio would have been no greater than 3.0 to 1.0 determined on a *pro forma* basis (including a *pro forma* application of the net proceeds therefrom), as if such Senior Secured Indebtedness had been incurred at the beginning of the relevant period.

The first paragraph of this covenant will not prohibit the Incurrence of the following items of Indebtedness:

- (1) Indebtedness Incurred pursuant to any Credit Facility (including in respect of letters of credit or bankers’ acceptances issued or created thereunder), and any Refinancing Indebtedness in respect thereof, in a maximum aggregate principal amount at any time outstanding not to exceed the greater of €1,500 million and 80% of Consolidated EBITDA; *plus* in the case of any refinancing of any Indebtedness permitted under this clause (1) or any portion thereof, the aggregate amount of fees, underwriting discounts, premiums and other costs and expenses Incurred in connection with such refinancing;
- (2) (a) Guarantees by Altice International or any Restricted Subsidiary of Indebtedness of Altice International or any Restricted Subsidiary to the extent such guaranteed Indebtedness was permitted to be incurred by another provision of this covenant; *provided* that (i) if such Indebtedness is subordinated in right of payment to, or *pari passu* in right of payment with, the Notes or a Note Guarantee, as applicable, then the Guarantee of such

Indebtedness shall be subordinated in right of payment to, or *pari passu* in right of payment with, the Notes or such Note Guarantee, as applicable, substantially to the same extent as such guaranteed Indebtedness and (ii) if such guarantee is of Indebtedness of the Issuer, a Guarantor, HOT, a HOT Proceeds Note Guarantor or an OMT Proceeds Loan Obligor, such Restricted Subsidiary complies with the first, second and third paragraph (as applicable) of the covenant described under “—*Additional Guarantors*”; or (b) without limiting the covenant described under “—*Limitation on Liens*”, Indebtedness arising by reason of any Lien granted by or applicable to Altice International or any Restricted Subsidiary securing Indebtedness of Altice International or any Restricted Subsidiary so long as the Incurrence of such Indebtedness is not prohibited by the terms of the Indenture;

- (3) Indebtedness of Altice International owing to and held by any Restricted Subsidiary, or Indebtedness of a Restricted Subsidiary owing to and held by Altice International or any other Restricted Subsidiary; *provided, however,* that if the Issuer or any Guarantor is the obligor on such Indebtedness and the payee is not the Issuer or a Guarantor, such Indebtedness must be unsecured and ((i) except in respect of the intercompany current liabilities incurred in connection with cash management positions of Altice International and the Restricted Subsidiaries and (ii) only to the extent legally permitted (Altice International and the Restricted Subsidiaries having completed all procedures required in the reasonable judgment of directors or officers of the obligee or obligor to protect such Persons from any penalty or civil or criminal liability in connection with the subordination of such Indebtedness)) expressly subordinated to the prior payment in full in cash of all obligations then due with respect to the Notes, in the case of the Issuer, or the Note Guarantee, in the case of a Guarantor; *provided that:*
- (i) any subsequent issuance or transfer of Capital Stock or any other event which results in any such Indebtedness being beneficially held by a Person other than Altice International or a Restricted Subsidiary; and
 - (ii) any sale or other transfer of any such Indebtedness to a Person other than Altice International or a Restricted Subsidiary,

shall be deemed, in each case, to constitute an Incurrence of such Indebtedness not permitted by this clause (3) by Altice International or such Restricted Subsidiary, as the case may be;

- (4) (a) Indebtedness represented by the Notes (other than any Additional Notes) issued on the Issue Date and the Note Guarantees, and Indebtedness under the New Senior Credit Facility incurred on or prior to the Completion Date in an aggregate amount not to exceed €841 million (equivalent as of the date of the New Senior Credit Facility) and the Guarantees thereof (b) any Indebtedness (other than Indebtedness described in clauses (1) and (3) of this paragraph) outstanding on the Issue Date, after giving effect to the Transactions, including the Issuance of the Notes, and the application of the proceeds thereof (including after such proceeds of the Notes are released from the Escrow Accounts), (c) Refinancing Indebtedness Incurred in exchange for, or the net proceeds of which are used to renew, refund, refinance, replace, defease or discharge any, or otherwise Incurred in respect of any, Indebtedness described in sub-clauses (a), (b) or (c) of this clause (4) or clause (5) of this paragraph or Incurred pursuant to the first paragraph of this covenant, (d) Management Advances and (e) Indebtedness represented by the Security Documents, the HOT Security Documents and the OMT Proceeds Loans Security Documents and including, with respect to each such Indebtedness, “parallel debt” obligations created under the Intercreditor Agreement, the HOT Security Documents, the Security Documents and the OMT Proceeds Loans Security Documents;
- (5) Indebtedness of (i) any Person outstanding on the date on which such Person becomes a Restricted Subsidiary or is merged, consolidated, amalgamated or otherwise combined with (including pursuant to any acquisition of assets and assumption of related liabilities) Altice International or a Restricted Subsidiary or (ii) the Issuer or a Guarantor Incurred to provide all or any portion of the funds utilized to consummate the transaction or series of related transactions pursuant to which a Person became a Restricted Subsidiary or was otherwise acquired by Altice International or a Restricted Subsidiary or otherwise in connection with or contemplation of such acquisition; *provided, however,* with respect to each of clause (5)(i) and (5)(ii), that immediately following the consummation of such acquisition or other transaction, (x)(i) if such Indebtedness is Senior Secured Indebtedness, the Issuer would have been able to incur €1.00 of additional Indebtedness pursuant to the first paragraph of this covenant after giving effect to the Incurrence of such Indebtedness pursuant to this clause (5) or (ii) the Consolidated Net Senior Secured Leverage Ratio would not be greater than it was immediately prior to giving effect to such acquisition or other transaction; and (y)(i) if such Indebtedness is not Senior Secured Indebtedness (including Indebtedness of Holdco that is Guaranteed by the Issuer or a Guarantor), the Issuer or a Guarantor would have been able to Guarantee €1.00 of additional Indebtedness of HoldCo pursuant to clause (15) of this paragraph after giving effect to the Incurrence of such Indebtedness pursuant to this clause (5) or (ii) the Consolidated Net Leverage Ratio would not be greater than it was immediately prior to giving effect to such acquisition or other transaction;

- (6) [Reserved];
- (7) (a) Indebtedness under Currency Agreements (other than Currency Agreements described in (b) below), Interest Rate Agreements and Commodity Hedging Agreements and (b) Indebtedness under Currency Agreements entered into in order to hedge any operating expenses and capital expenditures Incurred in the ordinary course of business so long as (i) such operating expenses and capital expenditures are denominated in euro or U.S. dollars and (ii) the term of any such Currency Agreement is not more than 360 days; in each case with respect to clauses (a) and (b) hereof, entered into for *bona fide* hedging purposes of Altice International or the Restricted Subsidiaries or (in respect of Currency Agreements and Interest Rate Agreements related to Indebtedness of HoldCo that is permitted to be Guaranteed by the Issuer and the Guarantors under clause (15) below) HoldCo and not for speculative purposes (as determined in good faith by an Officer or the Board of Directors of Altice International);
- (8) Indebtedness consisting of (A) mortgage financings, Purchase Money Obligations or other financings Incurred for the purpose of financing all or any part of the purchase price or cost of design, construction, installation or improvement of property (real or personal), plant or equipment or other assets (including Capital Stock) used or useful in a Similar Business or (B) Indebtedness otherwise Incurred to finance the purchase, lease, rental or cost of design, construction, installation or improvement of property (real or personal), plant or equipment that is used or useful in a Similar Business, whether through the direct purchase of assets or the Capital Stock of any Person owning such assets, and any Indebtedness which refinances, replaces or refunds such Indebtedness, in an aggregate outstanding principal amount which, when taken together with the principal amount of all other Indebtedness Incurred pursuant to this clause (8) and then outstanding, will not exceed at any time outstanding the greater of €350 million and 2.8% of Total Assets;
- (9) Indebtedness in respect of (a) workers' compensation claims, self-insurance obligations, performance, indemnity, surety, judgment, appeal, advance payment, customs, VAT or other tax or other guarantees or other similar bonds, instruments or obligations and completion guarantees and warranties provided by Altice International or a Restricted Subsidiary or relating to liabilities, obligations or guarantees Incurred in the ordinary course of business or in respect of any governmental requirement, including in relation to a governmental requirement to provide a guarantee or bond, (b) letters of credit, bankers' acceptances, guarantees or other similar instruments or obligations issued or relating to liabilities or obligations Incurred in the ordinary course of business, *provided, however*, that upon the drawing of such letters of credit or other instrument, such obligations are reimbursed within 30 days following such drawing; (c) the financing of insurance premiums in the ordinary course of business; and (d) any customary cash management, cash pooling or netting or setting off arrangements in the ordinary course of business;
- (10) Indebtedness arising from agreements providing for customary guarantees, indemnification, obligations in respect of earnouts or other adjustments of purchase price or, in each case, similar obligations, in each case, Incurred or assumed in connection with the acquisition or disposition of any business or assets or Person or any Capital Stock of a Subsidiary (other than Guarantees of Indebtedness Incurred by any Person acquiring or disposing of such business or assets or such Subsidiary for the purpose of financing such acquisition or disposition); *provided* that the maximum liability of Altice International and the Restricted Subsidiaries in respect of all such Indebtedness in connection with such disposition shall at no time exceed the gross proceeds, including the fair market value of non-cash proceeds (measured at the time received and without giving effect to any subsequent changes in value), actually received by Altice International and the Restricted Subsidiaries in connection with such disposition;
- (11) Indebtedness arising from the honoring by a bank or other financial institution of a check, draft or similar instrument drawn against insufficient funds in the ordinary course of business; *provided, however*, that such Indebtedness is extinguished within 30 Business Days of Incurrence;
- (12) Indebtedness under daylight borrowing facilities incurred in connection with any refinancing of Indebtedness (including by way of set-off or exchange); *provided* that such Indebtedness does not exceed the principal amount of the Indebtedness being refinanced and the aggregate amount of fees, underwriting discounts, premiums and other costs and expenses Incurred in connection with such refinancing, so long as any such Indebtedness is repaid within three days of the date on which such Indebtedness is Incurred;
- (13) Indebtedness Incurred by a Receivables Subsidiary in a Qualified Receivables Financing;
- (14) Indebtedness Incurred by the Issuer or a Guarantor (including any Refinancing Indebtedness in respect thereof) or Disqualified Stock of Altice International in an aggregate outstanding principal amount which, when taken together with the principal amount of all other Indebtedness Incurred pursuant to this clause (14) and then outstanding, will not exceed 100% of the Net Cash Proceeds received by Altice International and the Restricted

Subsidiaries from the issuance or sale (other than to Altice International or a Restricted Subsidiary) of its Subordinated Shareholder Funding (other than the AI Mandatory Convertible Notes) or Capital Stock (other than Disqualified Stock, Designated Preference Shares or an Excluded Contribution) or otherwise contributed to the equity (other than through the issuance of Disqualified Stock, Designated Preference Shares or an Excluded Contribution) of Altice International, in each case, subsequent to the Issue Date; *provided, however*, that (i) any such Net Cash Proceeds that are so received or contributed shall be excluded for purposes of making Restricted Payments under the first paragraph and clauses (1), (6) and (10) of the third paragraph of the covenant described below under “—*Certain Covenants—Limitation on Restricted Payments*” to the extent Altice International or a Restricted Subsidiary incurs Indebtedness in reliance thereon and (ii) any Net Cash Proceeds that are so received or contributed shall be excluded for purposes of incurring Indebtedness pursuant to this clause (14) to the extent Altice International or any Restricted Subsidiary makes a Restricted Payment under the first paragraph and clauses (1), (6) and (10) of the third paragraph of the covenant described below under “—*Certain Covenants—Limitation on Restricted Payments*” in reliance thereon;

- (15) (A) the Guarantee by the Issuer or any Guarantor of Indebtedness of HoldCo if, on the date of the Incurrence of such Guarantee, the Consolidated Net Leverage Ratio would have been no greater than 4.0 to 1.0, determined on a *pro forma* basis (including a *pro forma* application of the net proceeds from the Incurrence of such Indebtedness), as if such Guarantee had been Incurred at the beginning of the relevant two-quarter period, *provided* such Guarantees shall be subordinated to the Notes and the Note Guarantee of such Guarantor pursuant to the Intercreditor Agreement or any Additional Intercreditor Agreement to substantially the same extent, and on substantially the same terms as is customary for debt structures of this type on the Issue Date; and (B) the Incurrence of Indebtedness by the Issuer under a HoldCo Proceeds Loan representing all or substantially all of the net proceeds of a substantially concurrent Incurrence of Indebtedness by HoldCo that is guaranteed by the Issuer and the Guarantors pursuant to sub-clause (A) of this clause (15) or clauses (14) and (16) of this paragraph, *provided* that (i) any HoldCo Proceeds Loan is subordinated to the Notes to the same extent as the Guarantees referred to in clause (A) of this clause (15), and (ii) any HoldCo Proceeds Loan is granted as Notes Collateral and any payments under such HoldCo Proceeds Loan are subject to the Intercreditor Agreement or any Additional Intercreditor Agreement; and
- (16) Indebtedness Incurred (including any Refinancing Indebtedness in respect thereof) in an aggregate outstanding principal amount which, when taken together with the principal amount of all other Indebtedness Incurred pursuant to this clause (16) and then outstanding, will not exceed the greater of €500 million and 4.0% of Total Assets.

So long as Coditel Holding Lux S.à r.l. is not a Guarantor but is a Subsidiary of a Altice International, (i) none of Altice International or any other Guarantor shall permit the obligors under the Coditel Senior Credit Facility to extend the maturity thereof, reduce the interest rate payable thereon or make any unscheduled payment of principal thereon; *provided, however*, that the obligors under the Coditel Senior Credit Facility shall be permitted to prepay the Coditel Senior Credit Facility from time to time in an aggregate amount not to exceed €30 million.

Notwithstanding the foregoing, for so long as NewCo OMT is not a Guarantor, NewCo OMT and its Subsidiaries shall not be permitted to incur more than €30 million of Indebtedness at any time outstanding excluding any Indebtedness referred to in clauses (2)(a) (to the extent the Guarantee(s) relate to Indebtedness Incurred under clause (3) above), (3), (4)(d), (5), (8), (9), (10) and (11) of the second paragraph of this covenant.

In the event the Issuer Incurs any Indebtedness pursuant to the first paragraph of this covenant or clauses (8), (14), (15) (upon receipt from HoldCo of the Net Cash Proceeds of such Incurrence of such Indebtedness by HoldCo) or (16) of the second paragraph of this covenant, the Issuer will substantially concurrently with the Incurrence of such Indebtedness (or in the case of any Indebtedness the proceeds of which are deposited into an escrow account or similar arrangement pending the occurrence of one or more events, concurrently with the release of such proceeds from such escrow account or similar arrangement (other than in the case that such proceeds are returned to the holders of, or lenders under, such Indebtedness pursuant to the terms of such escrow account or similar arrangement)), make one or more Issuer Proceeds Loans to one or more Guarantors or (prior to the HOT Direct Obligation Event) to HOT and any of its Subsidiaries that are HOT Proceeds Note Guarantors (so long as HOT or such Subsidiary grants a Lien over its material assets and, in the case of such Subsidiary provides a HOT Proceeds Note Guarantee, in the amount of such additional Issuer Proceeds Loan) with all or substantially all of the net proceeds of the Incurrence of such Indebtedness by the Issuer.

For purposes of determining compliance with, and the outstanding principal amount of any particular Indebtedness Incurred pursuant to and in compliance with, this covenant:

- (1) in the event that Indebtedness meets the criteria of more than one of the types of Indebtedness described in the first and second paragraphs of this covenant, the Issuer, in its sole discretion, will classify, and may from time to time reclassify, such item of Indebtedness and only be required to include the amount and type of such

Indebtedness in one of the clauses of the second paragraph or the first paragraph of this covenant; *provided* that Indebtedness Incurred under clauses (1) and (15) of the second paragraph of the description of this covenant cannot be reclassified;

- (2) Guarantees of, or obligations in respect of letters of credit, bankers' acceptances or other similar instruments relating to, or Liens securing, Indebtedness that is otherwise included in the determination of a particular amount of Indebtedness shall not be included;
- (3) if obligations in respect of letters of credit, bankers' acceptances or other similar instruments are Incurred pursuant to any Credit Facility and are being treated as Incurred pursuant to clause (1), (8), (14) or (16) of the second paragraph above or the first paragraph above and the letters of credit, bankers' acceptances or other similar instruments relate to other Indebtedness, then such other Indebtedness shall not be included;
- (4) the principal amount of any Disqualified Stock of Altice International or a Restricted Subsidiary, or Preferred Stock of Altice International or a Restricted Subsidiary, will be equal to the greater of the maximum mandatory redemption or repurchase price (not including, in either case, any redemption or repurchase premium) or the liquidation preference thereof;
- (5) Indebtedness permitted by this covenant need not be permitted solely by reference to one provision permitting such Indebtedness but may be permitted in part by one such provision and in part by one or more other provisions of this covenant permitting such Indebtedness; and
- (6) the amount of Indebtedness issued at a price that is less than the principal amount thereof will be equal to the amount of the liability in respect thereof determined on the basis of IFRS.

Accrual of interest, accrual of dividends, the accretion of accreted value, the accretion or amortization of original issue discount, the payment of interest in the form of additional Indebtedness, the payment of dividends in the form of additional shares of Preferred Stock or Disqualified Stock or the reclassification of commitments or obligations not treated as Indebtedness due to a change in IFRS will not be deemed to be an Incurrence of Indebtedness for purposes of this covenant. The amount of any Indebtedness outstanding as of any date shall be (a) the accreted value thereof in the case of any Indebtedness issued with original issue discount and (b) the principal amount, or liquidation preference thereof, in the case of any other Indebtedness.

If at any time an Unrestricted Subsidiary becomes a Restricted Subsidiary, any Indebtedness of such Subsidiary shall be deemed to be Incurred by a Restricted Subsidiary as of such date (and, if such Indebtedness is not permitted to be Incurred as of such date under the covenant described under this "*—Limitation on Indebtedness*", the Issuer shall be in Default of this covenant).

For purposes of determining compliance with any euro-denominated restriction on the Incurrence of Indebtedness, the Euro Equivalent of the principal amount of Indebtedness denominated in another currency shall be calculated based on the relevant currency exchange rate in effect on the date such Indebtedness was Incurred, in the case of term Indebtedness, or at the option of the Issuer, on the date first committed, in the case of Indebtedness Incurred under a revolving credit facility; *provided* that (a) if such Indebtedness is Incurred to refinance other Indebtedness denominated in a currency other than euro, and such refinancing would cause the applicable euro-denominated restriction to be exceeded if calculated at the relevant currency exchange rate in effect on the date of such refinancing, such euro-denominated restriction shall be deemed not to have been exceeded so long as the principal amount of such Refinancing Indebtedness does not exceed the principal amount of such Indebtedness being refinanced; (b) the Euro Equivalent of the principal amount of any such Indebtedness outstanding on the Issue Date shall be calculated based on the relevant currency exchange rate in effect on the Issue Date; and (c) if any such Indebtedness that is denominated in a currency other than euros is subject to a Currency Agreement with respect to the currency in which such Indebtedness is denominated covering principal amount and interest payable on such Indebtedness, the amount of such Indebtedness, will be the Euro Equivalent of the principal payment required to be made under such Currency Agreement plus the Euro Equivalent of any premium which is at such time due and payable but is not covered by such Currency Agreement.

For purposes of determining compliance with the Consolidated Net Senior Secured Leverage Ratio or the Consolidated Net Leverage Ratio on the Incurrence of Indebtedness, the Euro Equivalent of the principal amount of Indebtedness denominated in another currency shall be calculated based on the relevant currency exchange rate in effect on the date such Indebtedness was Incurred, in the case of term Indebtedness, or at the option of the Issuer, the date first committed, in the case of Indebtedness Incurred under a revolving credit facility; *provided* that (a) if such Indebtedness is Incurred to refinance other Indebtedness denominated in a currency other than euro, and such refinancing would cause the applicable euro-denominated restriction to be exceeded if calculated at the relevant currency exchange rate in effect on the date of such refinancing, such euro-denominated restriction shall be deemed not to have been exceeded so long as the principal amount of such Refinancing Indebtedness does not exceed the principal amount of such Indebtedness being refinanced;

and (b) the Euro Equivalent of the principal amount of any such Indebtedness outstanding on the Issue Date shall be calculated based on the relevant currency exchange rate in effect on the Issue Date.

In addition, for purposes of calculating the Consolidated Net Senior Secured Leverage Ratio or the Consolidated Net Leverage Ratio to test compliance with any covenant in the Indenture, in determining the amount of Indebtedness outstanding in euro on any date of determination, with respect to any Indebtedness denominated in a currency other than euro (the “*Foreign Currency*”):

- (1) subject to a currency swap arrangement or contract, the aggregate principal amount of such Foreign Currency Indebtedness on any such date of determination shall be the euro amount of the aggregate principal amount to be paid by the Issuer or a Restricted Subsidiary on the maturity date of such currency swap arrangement or contract pursuant to the terms thereof; or
- (2) subject to a currency forward arrangement, forward accretion curve or contract, the aggregate principal amount of such Foreign Currency Indebtedness shall be converted into euro at the exchange rate specified under the terms of such currency forward arrangement, forward accretion curve or contract as applicable to such Foreign Currency Indebtedness on such date of determination.

For the avoidance of doubt, notwithstanding a Group member entering into any such arrangement or contract hedging foreign exchange exposure of any Foreign Currency Indebtedness, for the purposes of calculating the Consolidated Net Senior Secured Leverage Ratio or the Consolidated Net Leverage Ratio, the aggregate principal amount of Indebtedness subject to any such arrangement or contract shall be attributed to the total Indebtedness of the Person that originally Incurred such Indebtedness.

Notwithstanding any other provision of this covenant, the maximum amount of Indebtedness that Altice International or a Restricted Subsidiary may Incur pursuant to this covenant shall not be deemed to be exceeded solely as a result of fluctuations in the exchange rate of currencies.

Neither the Issuer nor any Guarantor will incur any Indebtedness (including any Indebtedness permitted to be Incurred pursuant to the second paragraph of this covenant) that is contractually subordinated in right of payment to any other Indebtedness of the Issuer or such Guarantor unless such Indebtedness is also contractually subordinated in right of payment to the Notes and the applicable Note Guarantee on substantially identical terms (as determined in good faith by the Issuer); *provided, however*, that no Indebtedness will be deemed to be contractually subordinated in right of payment to any other Indebtedness of the Issuer or any Guarantor solely by virtue of being unsecured, by virtue of being secured with different collateral, by virtue of being secured on a junior priority basis or by virtue of the application of waterfall or other payment-ordering provisions affecting different tranches of Indebtedness under Credit Facilities.

Limitation on Restricted Payments

Altice International will not, and will not permit any of its Restricted Subsidiaries to, directly or indirectly:

- (1) declare or pay any dividend or make any other payment or distribution on account of or in respect of Altice International’s or any Restricted Subsidiary’s Capital Stock (including, without limitation, any payment in connection with any merger or consolidation involving Altice International or any Restricted Subsidiary) except:
 - (a) dividends or distributions payable in Capital Stock of Altice International (other than Disqualified Stock) or in options, warrants or other rights to purchase such Capital Stock of Altice International (other than Disqualified Stock) or in Subordinated Shareholder Funding; and
 - (b) dividends or distributions payable to Altice International or a Restricted Subsidiary (and, in the case of any such Restricted Subsidiary making such dividend or distribution, to holders of its Capital Stock other than Altice International or another Restricted Subsidiary on no more than a *pro rata* basis, measured by value);
- (2) purchase, redeem, retire or otherwise acquire for value (including, without limitation, any payment in connection with any merger or consolidation involving the Issuer or Altice International) any (a) Capital Stock of Altice International or any direct or indirect Parent of Altice International held by Persons other than Altice International or a Restricted Subsidiary (other than in exchange for Capital Stock of Altice International (other than Disqualified Stock)) or (b) Capital Stock of HOT (including the Minority Shareholder Call Options) held by any party to a Minority Shareholder Purchase Agreement (other than Cool);
- (3) make any principal payment on, or purchase, repurchase, redeem, defease or otherwise acquire or retire for value, prior to scheduled maturity, scheduled repayment or scheduled sinking fund payment, any Subordinated

Indebtedness (other than (a) any such payment, purchase, repurchase, redemption, defeasance or other acquisition or retirement or in anticipation of satisfying a sinking fund obligation, principal installment or final maturity, in each case, due within one year of the date of payment, purchase, repurchase, redemption, defeasance or other acquisition or retirement; and (b) any Indebtedness Incurred pursuant to clause (3) of the second paragraph of the covenant described under “—*Limitation on Indebtedness*”);

- (4) make any cash payment on or with respect to, or purchase, redeem, defease or otherwise acquire or retire for value any Subordinated Shareholder Funding; or
- (5) make any Restricted Investment in any Person;

(any such dividend, distribution, payment, purchase, redemption, repurchase, defeasance, other acquisition, retirement or Restricted Investment referred to in clauses (1) through (5) are referred to herein as a “Restricted Payment”), if at the time Altice International or a Restricted Subsidiary makes such Restricted Payment:

- (a) a Default or Event of Default shall have occurred and be continuing (or would result immediately thereafter therefrom);
- (b) the Issuer and the Guarantors are not able to Guarantee €1.00 of in additional Indebtedness of HoldCo pursuant to clause (15) of the second paragraph of the covenant described under “—*Limitation on Indebtedness*”, after giving effect, on a *pro forma* basis, to such Restricted Payment; or
- (c) the aggregate amount of such Restricted Payment and all other Restricted Payments made by Altice International and the Restricted Subsidiaries subsequent to December 12, 2012 (and not returned or rescinded) (including Permitted Payments permitted below by clauses (5) (without duplication of amounts paid pursuant to any other clause of the immediately succeeding paragraph), (6), (10), (17) and (18) of the immediately succeeding paragraph, but excluding all other Restricted Payments permitted by the immediately succeeding paragraph) would exceed the sum of (without duplication):
 - (i) an amount equal to 100% of the Consolidated EBITDA for the period beginning on the first day of the first full fiscal quarter commencing prior to December 12, 2012 to the end of Altice International’s most recently ended full fiscal quarter ending prior to the date of such Restricted Payment for which internal consolidated financial statements of Altice International are available, taken as a single accounting period, less the product of 1.5 times the Consolidated Interest Expense for such period;
 - (ii) 100% of the aggregate Net Cash Proceeds, and the fair market value (as determined in accordance with the second last paragraph of this covenant) of property or assets or marketable securities, received by Altice International from the issue or sale of its Capital Stock (other than Disqualified Stock or Designated Preference Shares) or Subordinated Shareholder Funding subsequent to the Issue Date or otherwise contributed to the equity (other than through the issuance of Disqualified Stock or Designated Preference Shares) of Altice International subsequent to the Issue Date (other than (w) Net Cash Proceeds or property or assets or marketable securities received from an issuance or sale of such Capital Stock to Altice International or a Restricted Subsidiary or an employee stock ownership plan or trust established by Altice International or any Subsidiary of Altice International for the benefit of its employees to the extent funded by Altice International or any Restricted Subsidiary, (x) Net Cash Proceeds or property or assets or marketable securities to the extent that any Restricted Payment has been made from such proceeds in reliance on clause (6) of the immediately succeeding paragraph, (y) Excluded Contributions and (z) Net Cash Proceeds received from the AI Mandatory Convertible Notes);
 - (iii) 100% of the aggregate Net Cash Proceeds, and the fair market value (as determined in accordance with the second last paragraph of this covenant) of property or assets or marketable securities, received by Altice International or any Restricted Subsidiary from the issuance or sale (other than to Altice International or a Restricted Subsidiary or an employee stock ownership plan or trust established by Altice International or any Subsidiary of Altice International for the benefit of its employees to the extent funded by Altice International or any Restricted Subsidiary) by Altice International or any Restricted Subsidiary subsequent to the Issue Date of any Indebtedness that has been converted into or exchanged for Capital Stock of Altice International (other than Disqualified Stock or Designated Preference Shares) or Subordinated Shareholder Funding (plus the amount of any cash, and the fair market value (as determined in accordance with the second last paragraph of this covenant) of property or

assets or marketable securities, received by Altice International or any Restricted Subsidiary upon such conversion or exchange) but excluding (x) Net Cash Proceeds or property or assets or marketable securities to the extent that any Restricted Payment has been made from such proceeds in reliance on clause (6) of the immediately succeeding paragraph, and (y) Excluded Contributions;

- (iv) the amount equal to the net reduction in Restricted Investments made by Altice International or any of the Restricted Subsidiaries resulting from repurchases, redemptions or other acquisitions or retirements of any such Restricted Investment, proceeds realized upon the sale or other disposition to a Person other than Altice International or a Restricted Subsidiary of any such Restricted Investment, repayments of loans or advances or other transfers of assets (including by way of dividend, distribution, interest payments or returns of capital) to Altice International or any Restricted Subsidiary, which amount, in each case under this clause (iv), constituted a Restricted Payment made after the Issue Date; *provided, however*, that no amount will be included in Consolidated EBITDA for purposes of the preceding clause (i) to the extent that it is (at the Issuer's option) included under this clause (iv);
- (v) the amount of the cash and the fair market value (as determined in accordance with the second last paragraph of this covenant) of property, assets or marketable securities received by Altice International or any Restricted Subsidiary in connection with:
 - (a) the sale or other disposition (other than to Altice International or a Restricted Subsidiary or an employee stock ownership plan or trust established by Altice International or any Subsidiary of Altice International for the benefit of its employees to the extent funded by Altice International or any Restricted Subsidiary) of Capital Stock of an Unrestricted Subsidiary of Altice International; and
 - (b) any dividend or distribution made by an Unrestricted Subsidiary to Altice International or a Restricted Subsidiary;

which Unrestricted Subsidiary was designated as such after the Issue Date; *provided, however*, that no amount will be included in Consolidated EBITDA for purposes of the preceding clause (i) to the extent that it is (at the Issuer's option) included under this clause (v); and

- (vi) in the case of the designation of an Unrestricted Subsidiary as a Restricted Subsidiary or all of the assets of such Unrestricted Subsidiary are transferred to Altice International or a Restricted Subsidiary, or the Unrestricted Subsidiary is merged or consolidated into Altice International or a Restricted Subsidiary, 100% of such amount received in cash and the fair market value (as determined in accordance with the second last paragraph of this covenant) of any property, assets or marketable securities received by Altice International or Restricted Subsidiary in respect of such redesignation, merger, consolidation or transfer of assets, excluding any amount of any Investment in such Unrestricted Subsidiary pursuant to clause (16) of the definition of "Permitted Investment", in each case of this clause (vi), which Unrestricted Subsidiary was designated as such after the Issue Date; *provided however*, that no amount will be included in Consolidated EBITDA for purposes of the preceding clause (i) to the extent that it is (at the Issuer's option) included under this clause (vi); *provided further, however*, that such amount shall not exceed the amount included in the calculation of the amount of Restricted Payments referred to in the first sentence of this clause (c).

The foregoing provisions will not prohibit any of the following (collectively, "*Permitted Payments*"):

- (1) any Restricted Payment made in exchange (including any such exchange pursuant to the exercise of a conversion right or privilege in connection with which cash is paid in lieu of the issuance of fractional shares) for, or out of the Net Cash Proceeds of the substantially concurrent sale (other than to Altice International or a Subsidiary of Altice International) of, Capital Stock of Altice International (other than Disqualified Stock or Designated Preference Shares or through an Excluded Contribution), Subordinated Shareholder Funding (other than the AI Mandatory Convertible Notes) or a substantially concurrent contribution to the equity (other than through the issuance of Disqualified Stock or Designated Preference Shares or through an Excluded Contribution) of Altice International; *provided, however*, that to the extent so applied, the Net Cash Proceeds, or fair market value (as determined in accordance with the second last paragraph of this covenant) of property, assets or marketable

securities, from such sale of Capital Stock or Subordinated Shareholder Funding or such contribution will be excluded from clause (c)(ii) of the preceding paragraph and for purposes of the “Optional Redemption” provisions of the Indenture;

- (2) any purchase, repurchase, redemption, defeasance or other acquisition or retirement of Subordinated Indebtedness of the Issuer or any Guarantor made by exchange for, or out of the Net Cash Proceeds of the substantially concurrent Incurrence of, Refinancing Indebtedness permitted to be Incurred pursuant to the covenant described under “—*Limitation on Indebtedness*” above;
- (3) (a) any purchase, repurchase, redemption, defeasance or other acquisition or retirement of Preferred Stock of Altice International or a Restricted Subsidiary made by exchange for or out of the Net Cash Proceeds of the substantially concurrent sale of Preferred Stock of Altice International or a Restricted Subsidiary, and (b) any purchase, repurchase, redemption, defeasance or other acquisition or retirement of Disqualified Stock of Altice International or a Restricted Subsidiary made by exchange for or out of the Net Cash Proceeds of the substantially concurrent sale of Disqualified Stock of Altice International or a Restricted Subsidiary, as the case may be, that, in each case under (a) and (b), is permitted to be Incurred pursuant to the covenant described under “—*Limitation on Indebtedness*” above, and that in each case (other than such sale of Preferred Stock of Altice International that is not Disqualified Stock) constitutes Refinancing Indebtedness;
- (4) any purchase, repurchase, redemption, defeasance or other acquisition or retirement of Subordinated Indebtedness:
 - (a) (i) from Net Cash Proceeds of the Minority Shareholder Option Exercises permitted under “—*Offer to Repurchase with Minority Shareholder Option Proceeds*” and from Net Available Cash to the extent permitted under “—*Limitation on Sales of Assets and Subsidiary Stock*” below, but only if the Issuer shall have first complied with the terms described under “—*Offer to Repurchase with Minority Shareholder Option Proceeds*” above and “—*Limitation on Sales of Assets and Subsidiary Stock*”, as applicable, and purchased all Notes tendered pursuant to any offer to repurchase all the Notes required thereby, prior to purchasing, repurchasing, redeeming, defeasing or otherwise acquiring or retiring such Subordinated Indebtedness and (ii) at a purchase price not greater than 100% of the principal amount of such Subordinated Indebtedness plus accrued and unpaid interest;
 - (b) to the extent required by the agreement governing such Subordinated Indebtedness, following the occurrence of a Change of Control (or other similar event described therein as a “change of control”), but only (i) if required, if the Issuer shall have first complied with the terms described under “Change of Control” and purchased all Notes tendered pursuant to the offer to repurchase all the Notes required thereby, prior to purchasing, repurchasing, redeeming, defeasing or otherwise acquiring or retiring such Subordinated Indebtedness and (ii) at a purchase price not greater than 101% of the principal amount of such Subordinated Indebtedness plus accrued and unpaid interest; or
 - (c) consisting of Acquired Indebtedness (other than Indebtedness Incurred (A) to provide all or any portion of the funds utilized to consummate the transaction or series of related transactions pursuant to which such Person became a Restricted Subsidiary or was otherwise acquired by Altice International or a Restricted Subsidiary or (B) otherwise in connection with or contemplation of such acquisition) and at a purchase price not greater than 100% of the principal amount of such Acquired Indebtedness plus accrued and unpaid interest and any premium required by the terms of any Acquired Indebtedness;
- (5) any dividends paid within 60 days after the date of declaration if at such date of declaration such dividend would have complied with this covenant;

- (6) the purchase, repurchase, redemption, defeasance or other acquisition, cancellation or retirement for value of Capital Stock of Altice International, any Restricted Subsidiary or any Parent (including any options, warrants or other rights in respect thereof) and loans, advances, dividends or distributions by Altice International to any Parent to permit any Parent to purchase, repurchase, redeem, defease or otherwise acquire, cancel or retire for value Capital Stock of Altice International, any Restricted Subsidiary or any Parent (including any options, warrants or other rights in respect thereof), or payments to purchase, repurchase, redeem, defease or otherwise acquire, cancel or retire for value Capital Stock of Altice International, any Restricted Subsidiary or any Parent (including any options, warrants or other rights in respect thereof), in each case from Management Investors; *provided* that such payments, loans, advances, dividends or distributions do not exceed an amount (net of repayments of any such loans or advances) equal to (1) €20 million in any calendar year (with unused amounts in any calendar year being carried over to the succeeding calendar years; *provided* that the aggregate Restricted Payments made under this clause (6) do not exceed € 20 million in any fiscal year), *plus* (2) the Net Cash Proceeds received by Altice International or the Restricted Subsidiaries since the Issue Date (including through receipt of proceeds from the issuance or sale of its Capital Stock or Subordinated Shareholder Funding to a Parent) from, or as a contribution to the equity (in each case under this clause (6), other than through the issuance of Disqualified Stock or Designated Preference Shares) of Altice International from, the issuance or sale to Management Investors of Capital Stock (including any options, warrants or other rights in respect thereof), to the extent such Net Cash Proceeds are not included in any calculation under clause (c)(ii) of the first paragraph of this covenant;
- (7) the declaration and payment of dividends to holders of any class or series of Disqualified Stock, or of any Preferred Stock of a Restricted Subsidiary, Incurred in accordance with the terms of the covenant described under “—*Limitation on Indebtedness*” above;
- (8) purchases, repurchases, redemptions, defeasances or other acquisitions or retirements of Capital Stock deemed to occur upon the exercise of stock options, warrants or other rights in respect thereof if such Capital Stock represents a portion of the exercise price thereof;
- (9) dividends, loans, advances or distributions to any Parent or other payments by Altice International or any Restricted Subsidiary in amounts equal to (without duplication) the amounts required for any Parent to pay:
- (a) any Parent Expenses or any Related Taxes; and
- (b) amounts constituting or to be used for purposes of making payments to the extent specified in clauses (2) (with respect to fees and expenses incurred in connection with the transactions described therein), (5), and (11) of the second paragraph under “—*Limitation on Affiliate Transactions*;”
- (10) so long as no Default or Event of Default has occurred and is continuing (or would result therefrom), and for so long as Altice International or any Parent is a Public Company, the declaration and payment by Altice International of, or loans, advances, dividends or distributions to any Parent to pay, dividends on the common stock or common equity interests of Altice International or any Parent, in an amount not to exceed in any fiscal year the greater of (a) 6% of the Net Cash Proceeds received by Altice International from a Public Offering (other than the Initial Public Offering) or contributed to the equity (other than through the issuance of Disqualified Stock or Designated Preference Shares or through an Excluded Contribution) of Altice International or contributed as Subordinated Shareholder Funding (other than the AI Mandatory Convertible Notes) to Altice International and (b) an amount equal to the greater of (i) 5% of the Market Capitalization and (ii) 5% of the IPO Market Capitalization; *provided* that after giving *pro forma* effect to such loans, advances, dividends or distributions, the Consolidated Net Leverage Ratio shall be equal to or less than 4.0 to 1.0; *provided, further*, that if such Public Offering was of Capital Stock of a Parent, the net proceeds of any such dividend are used to fund a

corresponding dividend in equal or greater amount on the Capital Stock of such Parent;

- (11) payments by Altice International, or loans, advances, dividends or distributions to any Parent to make payments, to holders of Capital Stock of Altice International or any Parent in lieu of the issuance of fractional shares of such Capital Stock; *provided, however,* that any such payment, loan, advance, dividend or distribution shall not be for the purpose of evading any limitation of this covenant or otherwise to facilitate any dividend or other return of capital to the holders of such Capital Stock (as determined in good faith by an Officer or the Board of Directors of Altice International);
- (12) Restricted Payments in an aggregate amount outstanding at any time not to exceed the aggregate cash amount of Excluded Contributions, or consisting of non-cash Excluded Contributions, or Investments in exchange for or using as consideration Investments previously made under this clause (12);
- (13) payment of any Receivables Fees and purchases of Receivables Assets pursuant to a Receivables Repurchase Obligation in connection with a Qualified Receivables Financing;
- (14) dividends or other distributions of Capital Stock, Indebtedness or other securities of Unrestricted Subsidiaries;
- (15) (a) payments under a HoldCo Proceeds Loan that was Incurred in compliance with clause (15) of the second paragraph of the covenant described under “—*Limitation on Indebtedness*” above that are permitted to be made under the terms of the Intercreditor Agreement and any Additional Intercreditor Agreement for the purpose of making corresponding interest payments on Indebtedness of HoldCo that is Guaranteed by the Issuer and the Guarantors pursuant to clause (15) of the second paragraph of the covenant described under “—*Limitation on Indebtedness*” above and (b) so long as no Payment Block Event has occurred and is continuing, dividends or other distributions to HoldCo or Parent equal to the amount required by Altice S.A. for the payment of regularly scheduled interest as such amounts come due under the New ASA Notes;
- (16) the declaration and payment of dividends to holders of any class or series of Designated Preference Shares of Altice International issued after the Issue Date; *provided, however,* that the amount of all dividends declared or paid by Altice International pursuant to this clause (16) shall not exceed the Net Cash Proceeds received by Altice International from the issuance or sale of such Designated Preference Shares;
- (17) so long as no Default or Event of Default has occurred and is continuing (or would result therefrom), any Restricted Payment to the extent that, after giving *pro forma* effect to any such Restricted Payment, the Consolidated Net Leverage Ratio would be no greater than 4.0 to 1.0; and
- (18) so long as no Default or Event of Default has occurred and is continuing (or would result from), Restricted Payments in an aggregate amount outstanding at any time not to exceed the greater of €250 million and 2.0% of Total Assets.

The amount of all Restricted Payments (other than cash) shall be the fair market value on the date of such Restricted Payment of the asset(s) or securities proposed to be paid, transferred or issued by Altice International or such Restricted Subsidiary, as the case may be, pursuant to such Restricted Payment. The fair market value of any cash Restricted Payment shall be its face amount, and the fair market value of any non-cash Restricted Payment or any other property, assets or securities required to be valued by this covenant shall be determined conclusively by an Officer or the Board of Directors of Altice International acting in good faith.

For purposes of determining compliance with this covenant, in the event that a Restricted Payment meets the criteria of more than one of the categories described in clauses (1) through (18) above, or is permitted pursuant to the first paragraph of this covenant, Altice International will be entitled to classify such Restricted Payment (or portion thereof)

on the date of its payment or later reclassify such Restricted Payment (or portion thereof) in any manner that complies with this covenant.

Limitation on Liens

Altice International will not, and will not permit any of its Restricted Subsidiaries to, directly or indirectly, create, incur or suffer to exist any Lien upon any of their property or assets (including Capital Stock of a Restricted Subsidiary), whether owned on the Issue Date or acquired after that date, or any interest therein or any income or profits therefrom, which Lien is securing any Indebtedness (such Lien, the “*Initial Lien*”), except (a) in the case of any property or asset that does not constitute Notes Collateral, HOT Proceeds Note Collateral or OMT Proceeds Loans Collateral, (i) Permitted Liens or (ii) Liens on assets that are not Permitted Liens if the Notes and the Indenture (or a Note Guarantee in the case of Liens of a Guarantor) are directly secured equally and ratably with, or prior to, in the case of Liens with respect to Subordinated Indebtedness, the Indebtedness secured by such Initial Lien for so long as such Indebtedness is so secured, (b) in the case of any property or assets that constitutes Notes Collateral, Permitted Collateral Liens, (c) in the case of any property or assets that constitutes HOT Proceeds Note Collateral, Permitted HOT Proceeds Note Collateral Liens; and (d) in the case of any property or assets that constitutes OMT Proceeds Loans Collateral, Permitted OMT Proceeds Loans Collateral Liens.

Any such Lien created in favor of the Notes pursuant to clause (a)(ii) of the preceding paragraph will be automatically and unconditionally released and discharged upon (i) the release and discharge of the Initial Lien to which it relates, and (ii) otherwise as set forth under “—*Notes Security—Release of Notes Collateral.*”

Limitation on Restrictions on Distributions from Restricted Subsidiaries

Altice International will not, and will not permit any of its Restricted Subsidiaries to, create or otherwise cause or permit to exist or become effective any consensual encumbrance or consensual restriction on the ability of Altice International or any Restricted Subsidiary to:

- (A) pay dividends or make any other distributions in cash or otherwise on its Capital Stock to Altice International or any Restricted Subsidiary or pay any Indebtedness or other obligations owed to Altice International or any Restricted Subsidiary;
- (B) make any loans or advances to Altice International or any Restricted Subsidiary; or
- (C) sell, lease or transfer any of its property or assets to Altice International or any Restricted Subsidiary,

provided that (x) the priority of any Preferred Stock in receiving dividends or liquidating distributions prior to dividends or liquidating distributions being paid on common stock and (y) the subordination of (including the application of any standstill requirements to) loans or advances made to Altice International or any Restricted Subsidiary to other Indebtedness Incurred by Altice International or any Restricted Subsidiary shall not be deemed to constitute such an encumbrance or restriction.

The provisions of the preceding paragraph will not prohibit:

- (1) any encumbrance or restriction pursuant to any Credit Facility or any other agreement or instrument, in each case, in effect at or entered into on the Issue Date (other than the Minority Shareholder Purchase Agreements), and any amendments, restatements, modifications, renewals, supplements, refundings, replacements or refinancings of such agreements; *provided that* the amendments, restatements, modifications, renewals, supplements, refundings, replacements or refinancings are not materially more restrictive, taken as a whole, with respect to such dividend and other payment restrictions than those contained in those agreements on the Issue Date (as determined in good faith by the Issuer);
- (2) the Minority Shareholder Purchase Agreements as in effect on December 12, 2012;
- (3) encumbrances or restrictions existing under or by reason of the Indenture, the Notes, the Note Guarantees, the Existing Senior Secured Notes and the Guarantees thereof, the Existing Senior Secured Notes Indenture, the Existing Senior Notes and the Guarantees thereof, the New Senior Notes and the Guarantees thereof, and the Existing ASA Notes, the indentures governing the Existing Senior Notes, the Existing ASA Notes, the New Senior Notes, the Senior Credit Facilities, the Coditel Senior Credit Facility, the Coditel Intercreditor Agreement, the Revolving Credit Facilities, the Existing ASA Revolving Credit Facility, the Intercreditor Agreement, any Additional Intercreditor Agreement, the Notes Escrow Agreement, the New Senior Notes Escrow Agreement, the Security Documents, the Senior Secured Notes Security Documents, the HOT Proceeds Note, the Existing HOT Unsecured Notes, the HOT Security Documents, the HOT Credit Facility, the OMT

Proceeds Loans and each OMT Proceeds Loans Security Document and the Issuer Proceeds Loans (other than the HOT Proceeds Note);

- (4) any encumbrance or restriction pursuant to an agreement or instrument of a Person or relating to any Capital Stock or Indebtedness of a Person, entered into on or before the date on which (i) such Person was acquired by or merged, consolidated or otherwise combined with or into Altice International or any Restricted Subsidiary, (ii) such agreement or instrument is assumed by Altice International or any Restricted Subsidiary in connection with an acquisition of assets or (iii) such Person became a Restricted Subsidiary (in each case, other than Capital Stock or Indebtedness Incurred as consideration in, or to provide all or any portion of the funds utilized to consummate, the transaction or series of related transactions pursuant to which such Person became a Restricted Subsidiary or was acquired by Altice International or was merged, consolidated or otherwise combined with or into Altice International or any Restricted Subsidiary) and outstanding on such date; *provided* that, for the purposes of this clause (4), if another Person is the Successor Company (as defined under “—*Merger and Consolidation*”) or any Subsidiary thereof, any agreement or instrument of such Person or any such Subsidiary shall be deemed acquired or assumed by Altice International or any Restricted Subsidiary when such Person becomes the Successor Company;
- (5) any encumbrance or restriction pursuant to an agreement or instrument effecting a refunding, replacement or refinancing of Indebtedness Incurred pursuant to, or that otherwise extends, renews, refunds, refinances or replaces, an agreement or instrument referred to in clause (1), (3) or (4) of this paragraph or this clause (5) (an “*Initial Agreement*”) or contained in any amendment, supplement or other modification to an agreement referred to in clause (1), (3) or (4) of this paragraph or this clause (5); *provided, however*, that the encumbrances and restrictions with respect to such Restricted Subsidiary contained in any such agreement or instrument are no less favorable in any material respect to the Holders taken as a whole than the encumbrances and restrictions contained in the Initial Agreement or Initial Agreements to which such refinancing or amendment, supplement or other modification relates (as determined in good faith by the Issuer);
- (6) any encumbrance or restriction:
 - (a) that restricts in a customary manner the subletting, assignment or transfer of any property or asset that is subject to a lease, license or similar contract, or the assignment or transfer of any lease, license or other contract;
 - (b) contained in mortgages, pledges or other security agreements permitted under the Indenture or securing Indebtedness of Altice International or a Restricted Subsidiary permitted under the Indenture to the extent such encumbrances or restrictions restrict the transfer of the property or assets subject to such mortgages, pledges or other security agreements;
 - (c) pursuant to customary provisions restricting dispositions of real property interests set forth in any reciprocal easement agreements of Altice International or any Restricted Subsidiary; or
 - (d) pursuant to the terms of any license, authorization, concession or permit;
- (7) any encumbrance or restriction pursuant to Purchase Money Obligations and Capitalized Lease Obligations permitted under the Indenture, in each case, that impose encumbrances or restrictions on the property so acquired or any encumbrance or restriction pursuant to a joint venture agreement that imposes restrictions on the transfer of the assets of the joint venture;
- (8) any encumbrance or restriction with respect to a Restricted Subsidiary (or any of its property or assets) imposed pursuant to an agreement entered into for the direct or indirect sale or disposition to a Person of all or substantially all the Capital Stock or assets of such Restricted Subsidiary (or the property or assets that are subject to such restriction) pending the closing of such sale or disposition;
- (9) customary provisions in leases, licenses, joint venture agreements and other similar agreements and instruments entered into in the ordinary course of business;
- (10) encumbrances or restrictions arising or existing by reason of applicable law or any applicable rule, regulation, governmental license or order, or required by any regulatory authority or stock exchange;
- (11) any encumbrance or restriction on cash or other deposits or net worth imposed by customers under agreements entered into in the ordinary course of business;

- (12) any encumbrance or restriction pursuant to Currency Agreements, Interest Rate Agreements or Commodity Hedging Agreements;
- (13) any encumbrance or restriction arising pursuant to an agreement or instrument relating to any Indebtedness permitted to be Incurred subsequent to the Issue Date pursuant to the provisions of the covenant described under “—*Limitation on Indebtedness*” if the encumbrances and restrictions contained in any such agreement or instrument taken as a whole are not materially less favorable to the Holders of the Notes than (i) the encumbrances and restrictions contained in the Revolving Credit Facilities or Senior Credit Facilities on the Issue Date, together with the security documents associated therewith, if any, and the Intercreditor Agreement, as in effect on or immediately prior to the Completion Date or (ii) is customary in comparable financings (as determined in good faith by the Issuer) and where, in the case of clause (ii), the Issuer determines at the time of issuance of such Indebtedness that such encumbrances or restrictions (x) will not adversely affect, in any material respect, the Issuer’s ability to make principal or interest payments on the Notes as and when they become due or (y) such encumbrances and restrictions apply only if a default occurs in respect of a payment or financial covenant relating to such Indebtedness;
- (14) restrictions effected in connection with a Qualified Receivables Financing that, in the good faith determination of an Officer or the Board of Directors of Altice International, are necessary or advisable to effect such Qualified Receivables Financing; or
- (15) any encumbrance or restriction existing by reason of any Lien permitted under “—*Limitation on Liens*”.

Limitation on Sales of Assets and Subsidiary Stock

The Issuer will not make any Issuer Asset Sale.

Subject to the immediately preceding paragraph, Altice International will not, and will not permit any of its Restricted Subsidiaries to, make any Asset Disposition unless:

- (1) Altice International or such Restricted Subsidiary, as the case may be, receives consideration (including by way of relief from, or by any other Person assuming responsibility for, any liabilities, contingent or otherwise) at least equal to the fair market value (such fair market value to be determined on the date of contractually agreeing to such Asset Disposition), as determined in good faith by an Officer or the Board of Directors of Altice International, of the shares and assets subject to such Asset Disposition (including, for the avoidance of doubt, if such Asset Disposition is a Permitted Asset Swap); and
- (2) in any such Asset Disposition, or series of related Asset Dispositions (except to the extent the Asset Disposition is a Permitted Asset Swap), at least 75% of the consideration from such Asset Disposition or such series of related Asset Dispositions (excluding any consideration by way of relief from, or by any other Person assuming responsibility for, any liabilities, contingent or otherwise, other than Indebtedness) received by Altice International or such Restricted Subsidiary, as the case may be, is in the form of cash, Cash Equivalents or Temporary Cash Investments.

After the receipt of Net Available Cash from an Asset Disposition, Altice International or a Restricted Subsidiary, as the case may be, may apply such Net Available Cash directly or indirectly (at the option of Altice International or such Restricted Subsidiary):

- (a) (1) within 365 days from the later of (A) the date of such Asset Disposition and (B) the receipt of such Net Available Cash (i) to prepay, repay, purchase or redeem any Indebtedness incurred under clause (1) of the second paragraph of the covenant described under “—*Limitation on Indebtedness*”; *provided, however*, that, in connection with any prepayment, repayment or purchase of Indebtedness pursuant to this clause (a)(i), Altice International or such Restricted Subsidiary will retire such Indebtedness and will cause the related commitment (if any) (except in the case of any revolving Indebtedness) to be permanently reduced in an amount equal to the principal amount so prepaid, repaid, purchased or redeemed; (ii) unless included in clause (a)(i), to prepay, repay, purchase or redeem the Existing HOT Unsecured Notes and, if not owed to Altice International or an Affiliate, Coditel Senior Facility, or any *Pari Passu* Indebtedness of the Issuer or a Guarantor that is secured in whole or in part by a Lien on the Notes Collateral, which Lien ranks *pari passu* with the Liens securing the Notes, at a price of no more than 100% of the principal amount of such *Pari Passu* Indebtedness plus accrued and unpaid interest to the date of such prepayment, repayment, purchase or redemption; *provided* that the Issuer or such Guarantor shall prepay, redeem, repay or repurchase *Pari Passu* Indebtedness that is Public Debt pursuant to this clause (ii) only if the Issuer or such Guarantor makes an offer to the holders of the Notes to purchase their Notes in accordance with the provisions set forth below for an Asset Disposition Offer for an aggregate principal amount of Notes at least equal to the proportion that (x) the total aggregate principal amount

of Notes outstanding bears to (y) the sum of the total aggregate principal amount of Notes outstanding plus the total aggregate principal amount outstanding of such Pari Passu Indebtedness; (iii) to prepay, repay, purchase or redeem any Indebtedness of a Restricted Subsidiary that is not a Guarantor or any Indebtedness that is secured on assets which do not constitute Notes Collateral (in each case, other than Subordinated Indebtedness of the Issuer or a Guarantor or Indebtedness owed to Altice International or any Restricted Subsidiary); (iv) to purchase the Notes pursuant to an offer to all holders of Notes at a purchase price in cash equal to at least 100% of the principal amount of the Notes, plus accrued and unpaid interest to, but not including, the date of purchase (subject to the right of Holders of record on the relevant record date to receive interest due on the relevant interest payment date); or (v) in the manner specified under sub-clause (3) of the definition of “*Change of Control*”;

- (b) to the extent Altice International or such Restricted Subsidiary elects, to invest in or purchase or commit to invest in or purchase Additional Assets (including by means of an investment in Additional Assets by a Restricted Subsidiary with Net Available Cash received by Altice International or another Restricted Subsidiary) within 365 days from the later of (i) the date of such Asset Disposition and (ii) the receipt of such Net Available Cash; *provided, however*, that any such reinvestment in Additional Assets made pursuant to a definitive binding agreement or a commitment approved by the Board of Directors of Altice International that is executed or approved within such time will satisfy this requirement, so long as such investment or commitment to invest is consummated within 180 days of such 365th day;
- (c) to make a capital expenditure within 365 days from the later of (A) the date of such Asset Disposition and (B) the receipt of such Net Available Cash; *provided, however*, that any such capital expenditure made pursuant to a definitive binding agreement or a commitment approved by the Board of Directors of Altice International that is executed or approved within such time will satisfy this requirement, so long as such investment is consummated within 180 days of such 365th day; or
- (d) any combination of the foregoing.

provided that, pending the final application of any such Net Available Cash in accordance with clause (a), (b), (c) or (d) above, Altice International and the Restricted Subsidiaries may temporarily reduce Indebtedness or otherwise invest such Net Available Cash in any manner not prohibited by the Indenture.

Any Net Available Cash from Asset Dispositions that is not applied or invested or committed to be applied or invested as provided in the preceding paragraph will be deemed to constitute “Excess Proceeds”. On the 366th day (or the 546th day, in the case of any Net Available Cash committed to be used pursuant to a definitive binding agreement or commitment approved by the Board of Directors of Altice International pursuant to clauses (b) or (c) of the third paragraph of this covenant) after the later of (A) the date of such Asset Disposition and (B) the receipt of such Net Available Cash, if the aggregate amount of Excess Proceeds exceeds € 25 million, the Issuer will be required within ten (10) Business Days thereof to make an offer (“*Asset Disposition Offer*”) to all holders of Notes and, to the extent the Issuer elects or the Issuer or a Guarantor is required by the terms of other outstanding Pari Passu Indebtedness, to all holders of such other outstanding Pari Passu Indebtedness to purchase the maximum principal amount of Notes and any such Pari Passu Indebtedness to which the Asset Disposition Offer applies that may be purchased out of the Excess Proceeds, at an offer price in respect of the Notes in an amount equal to (and, in the case of any Pari Passu Indebtedness, an offer price of no more than) 100% of the principal amount of the Notes and 100% of the principal amount of Pari Passu Indebtedness, in each case, plus accrued and unpaid interest, if any, to, but not including, the date of purchase, in accordance with the procedures set forth in the Indenture or the agreements governing the Pari Passu Indebtedness, as applicable, and in the case of the Notes, in minimum denominations of \$200,000 and in integral multiples of \$1,000 in excess thereof, in the case of Dollar Notes, and € 100,000 principal amount and integral multiples of €1,000 in excess thereof, in the case of Euro Notes.

To the extent that the aggregate amount of Notes and Pari Passu Indebtedness so validly tendered and not properly withdrawn pursuant to an Asset Disposition Offer is less than the Excess Proceeds, Altice International and the Restricted Subsidiaries may use any remaining Excess Proceeds for general corporate purposes, to the extent not prohibited by the other covenants contained in the Indenture. If the aggregate principal amount of the Notes surrendered in any Asset Disposition Offer by Holders and other Pari Passu Indebtedness surrendered by holders or lenders, collectively, exceeds the amount of Excess Proceeds, the Excess Proceeds shall be allocated among the Notes and Pari Passu Indebtedness to be purchased on a *pro rata* basis on the basis of the aggregate principal amount of tendered Notes and Pari Passu Indebtedness. For the purposes of calculating the principal amount of any such Indebtedness not denominated in euro, such Indebtedness shall be calculated by converting any such principal amounts into their Euro Equivalent determined as of a date selected by the Issuer that is within the Asset Disposition Offer Period (as defined below). Upon completion of any Asset Disposition Offer, the amount of Excess Proceeds shall be reset at zero.

To the extent that any portion of Net Available Cash payable in respect of the Notes is denominated in a currency other than the currency in which the relevant Notes are denominated, the amount thereof payable in respect of such Notes shall not exceed the net amount of funds in the currency in which such Notes are denominated that is actually received by the Issuer upon converting such portion of the Net Available Cash into such currency.

The Asset Disposition Offer, in so far as it relates to the Notes, will remain open for a period of not less than 20 Business Days following its commencement (the “*Asset Disposition Offer Period*”). No later than five (5) Business Days after the termination of the Asset Disposition Offer Period (the “*Asset Disposition Purchase Date*”), the Issuer will purchase the principal amount of Notes and, to the extent it elects, Pari Passu Indebtedness required to be purchased by it pursuant to this covenant (the “*Asset Disposition Offer Amount*”) or, if less than the Asset Disposition Offer Amount has been so validly tendered, all Notes and Pari Passu Indebtedness validly tendered in response to the Asset Disposition Offer.

On or before the Asset Disposition Purchase Date, the Issuer will, to the extent lawful, accept for payment, on a *pro rata* basis to the extent necessary, the Asset Disposition Offer Amount of Notes and Pari Passu Indebtedness or portions of Notes and Pari Passu Indebtedness so validly tendered and not properly withdrawn pursuant to the Asset Disposition Offer, or if less than the Asset Disposition Offer Amount has been validly tendered and not properly withdrawn, all Notes and Pari Passu Indebtedness so validly tendered and not properly withdrawn and, in the case of the Notes, in minimum denominations of \$200,000 and in integral multiples of \$1,000 in excess thereof, in the case of Dollar Notes, and €100,000 principal amount and integral multiples of €1,000 in excess thereof, in the case of Euro Notes. The Issuer will deliver to the Trustee an Officer’s Certificate stating that such Notes or portions thereof were accepted for payment by the Issuer in accordance with the terms of this covenant. The Issuer or the Paying Agent, as the case may be, will promptly (but in any case not later than five (5) Business Days after termination of the Asset Disposition Offer Period) mail or deliver to each tendering Holder of Notes an amount equal to the purchase price of the Notes so validly tendered and not properly withdrawn by such Holder, and accepted by the Issuer for purchase, and the Issuer will promptly issue a new Note (or amend the applicable Global Note), and the Trustee, upon delivery of an Officer’s Certificate from the Issuer, will, via an authenticating agent, authenticate and mail or deliver (or cause to be transferred by book-entry) such new Note to such Holder, in a principal amount equal to any unpurchased portion of the Note surrendered; *provided* that each such new Note will be in a principal amount with a minimum denomination of \$200,000, in the case of Dollar Notes, and € 100,000, in the case of Euro Notes. Any Note not so accepted will be promptly mailed or delivered (or transferred by book-entry) by the Issuer to the Holder thereof.

For the purposes of clause (2) of the first paragraph of this covenant, the following will be deemed to be cash:

- (1) the assumption by the transferee of Indebtedness of Altice International or any Restricted Subsidiary (other than Subordinated Indebtedness of the Issuer or a Guarantor) and the release of Altice International or such Restricted Subsidiary from all liability on such Indebtedness in connection with such Asset Disposition;
- (2) securities, notes or other obligations received by Altice International or any Restricted Subsidiary from the transferee that are converted by Altice International or such Restricted Subsidiary into cash or Cash Equivalents within 180 days following the closing of such Asset Disposition, to the extent of the cash received;
- (3) Indebtedness of any Restricted Subsidiary that is no longer a Restricted Subsidiary as a result of such Asset Disposition, to the extent that Altice International and each other Restricted Subsidiary (as applicable) are released from any Guarantee of payment of such Indebtedness in connection with such Asset Disposition;
- (4) consideration consisting of Indebtedness of the Issuer or a Guarantor (other than Subordinated Indebtedness) received after the Issue Date from Persons who are not Altice International or any Restricted Subsidiary; and
- (5) any Designated Non-Cash Consideration received by Altice International or any Restricted Subsidiary in such Asset Dispositions having an aggregate fair market value, taken together with all other Designated Non-Cash Consideration received pursuant to this covenant that is at that time outstanding, not to exceed the greater of €185 million and 1.5% of Total Assets (with the fair market value of each item of Designated Non-Cash Consideration being measured at the time received and without giving effect to subsequent changes in value).

The Issuer will comply, to the extent applicable, with the requirements of Section 14(e) of the Exchange Act and any other securities laws or regulations in connection with the repurchase of Notes pursuant to the Indenture. To the extent that the provisions of any securities laws or regulations conflict with provisions of this covenant, the Issuer will comply with the applicable securities laws and regulations and will not be deemed to have breached its obligations under the Indenture by virtue of any conflict.

Limitation on Affiliate Transactions

Altice International will not and will not permit any of its Restricted Subsidiaries to, directly or indirectly, enter into or conduct any transaction or series of related transactions (including the purchase, sale, lease or exchange of any property or the rendering of any service) with any Affiliate of Altice International (any such transaction or series of related transactions being “Affiliate Transactions”) involving aggregate value in excess of €5 million unless:

- (1) the terms of such Affiliate Transaction taken as a whole are not materially less favorable to Altice International or such Restricted Subsidiary, as the case may be, than those that could be obtained in a comparable transaction at the time of such transaction or the execution of the agreement providing for such transaction in arm’s-length dealings with a Person who is not such an Affiliate; and
- (2) in the event such Affiliate Transaction involves an aggregate value in excess of €25 million, the terms of such transaction or series of related transactions have been approved by a resolution of the majority of the members of the Board of Directors of Altice International resolving that such transaction complies with clause (1) above; *provided* that an Affiliate Transaction shall be deemed to have satisfied the requirements set forth in this clause (2) of this paragraph if such Affiliate Transaction is approved by a majority of the Disinterested Directors. If there are no Disinterested Directors, any Affiliate Transaction shall also be deemed to have satisfied the requirements set forth in this covenant if Altice International or any of its Restricted Subsidiaries, as the case may be, delivers to the Trustee a letter from an Independent Financial Advisor stating that such transaction is fair to Altice International or such Restricted Subsidiary from a financial point of view or stating that the terms are not materially less favorable to Altice International or its relevant Restricted Subsidiary than those that would have been obtained in a comparable transaction by Altice International or such Restricted Subsidiary with an unrelated Person on arm’s length basis.

The provisions of the preceding paragraph will not apply to:

- (1) any Restricted Payment permitted to be made pursuant to the covenant described under “—*Limitation on Restricted Payments*”, any Permitted Payments (other than pursuant to clause (9)(b) of the third paragraph of the covenant described under “—*Limitation on Restricted Payments*”) or any Permitted Investment (other than Permitted Investments as defined in paragraphs (1)(b), (2) and (17) of the definition thereof);
- (2) any issuance or sale of Capital Stock, options, other equity-related interests or other securities, or other payments, awards or grants in cash, securities or otherwise pursuant to, or the funding of, or entering into, or maintenance of, any employment, consulting, collective bargaining or benefit plan, program, agreement or arrangement, related trust or other similar agreement and other compensation arrangements, options, warrants or other rights to purchase Capital Stock of Altice International, any Restricted Subsidiary or any Parent, restricted stock plans, long-term incentive plans, stock appreciation rights plans, participation plans or similar employee benefits or consultants’ plans (including valuation, health, insurance, deferred compensation, severance, retirement, savings or similar plans, programs or arrangements) or indemnities provided on behalf of officers, employees, directors or consultants approved by the Board of Directors of Altice International, in each case in the ordinary course of business;
- (3) any Management Advances and any waiver or transaction with respect thereto;
- (4) any transaction between or among Altice International and any Restricted Subsidiary (or entity that becomes a Restricted Subsidiary as a result of such transaction), or between or among Altice International, Restricted Subsidiaries or any Receivables Subsidiary;
- (5) the payment of reasonable fees and reimbursement of expenses to, and customary indemnities and employee benefit and pension expenses provided on behalf of, directors, officers, consultants or employees of Altice International, any Restricted Subsidiary or any Parent (whether directly or indirectly and including through any Person owned or controlled by any of such directors, officers or employees);
- (6) the Transactions and the entry into and performance of obligations of Altice International or any of its Restricted Subsidiaries under the terms of any transaction arising out of, and any payments pursuant to or for purposes of funding, any agreement or instrument in effect as of or on the Issue Date, as these agreements and instruments may be amended, modified, supplemented, extended, renewed or refinanced from time to time (including, without limitation, to add additional Persons in connection with any such Person becoming a Restricted Subsidiary) in accordance with the other terms of this covenant or to the extent not more disadvantageous to the Holders in any material respect and the entry into and performance of any registration rights or other listing agreement in connection with any Public Offering (including the Initial Public Offering);

- (7) execution, delivery and performance of any Tax Sharing Agreement or the formation and maintenance of any consolidated group for tax, accounting or management purposes in the ordinary course of business;
- (8) transactions with customers, clients, suppliers or purchasers or sellers of goods or services and Associates, in each case in the ordinary course of business (including, without limitation, pursuant to joint venture arrangements), which are fair to Altice International or the relevant Restricted Subsidiary in the reasonable determination of the Board of Directors or an officer of Altice International or the relevant Restricted Subsidiary, or are on terms no less favorable than those that could reasonably have been obtained at such time from an unaffiliated party;
- (9) any transaction in the ordinary course of business between or among Altice International or any Restricted Subsidiary and any Affiliate of Altice International or an Associate or similar entity (in each case, other than an Unrestricted Subsidiary) that would constitute an Affiliate Transaction solely because Altice International or a Restricted Subsidiary or any Affiliate of Altice International or a Restricted Subsidiary or any Affiliate of any Permitted Holder owns an equity interest in or otherwise controls such Affiliate, Associate or similar entity;
- (10) (a) issuances or sales of Capital Stock (other than Disqualified Stock or Designated Preference Shares) of Altice International or options, warrants or other rights to acquire such Capital Stock or Subordinated Shareholder Funding; *provided* that the interest rate and other financial terms of such Subordinated Shareholder Funding are approved by a majority of the members of the Board of Directors of Altice International in their reasonable determination and (b) any amendment, waiver or other transaction with respect to any Subordinated Shareholder Funding in compliance with the other provisions of the Indenture, the Intercreditor Agreement or any Additional Intercreditor Agreement, as applicable;
- (11) without duplication in respect of payments made pursuant to the definition of Parent Expenses, (a) payments by Altice International or any Restricted Subsidiary to any Permitted Holder (whether directly or indirectly, including through any Parent) of annual management, consulting, monitoring or advisory fees and related expenses in an aggregate amount not to exceed an amount equal to the greater of €20 million or 1.0% of Consolidated EBITDA (as reported by Altice International in the financial statements delivered pursuant to clause (1) of the covenant under “*Reports*” for the most recent fiscal year ended prior to the date of determination) per year; (b) customary payments by Altice International or any Restricted Subsidiary to any Permitted Holder (whether directly or indirectly, including through any Parent) for financial advisory, financing, underwriting or placement services or in respect of other investment banking activities, including in connection with acquisitions or divestitures, which payments in respect of this clause (b) are approved by a majority of the Board of Directors of Altice International in good faith; and (c) payments of all fees and expenses related to the Transactions;
- (12) any transaction effected as part of a Qualified Receivables Financing;
- (13) the Incurrence of HoldCo Proceeds Loans and Guarantees of Indebtedness of Holdco, in each case, permitted to be Incurred under paragraph of the covenant described under “—*Limitation on Indebtedness*”; and
- (14) any participation in a rights offer or public tender or exchange offers for securities or debt instruments issued by Altice International or any of its Subsidiaries that are conducted on arm’s length terms and provide for the same price or exchange ratio, as the case may be, to all holders accepting such rights, tender or exchange offer.

Maintenance of Listing

The Issuer will use its commercially reasonable efforts to maintain the listing of the Notes on the Official List of the Luxembourg Stock Exchange and the admission to trading on its Euro MTF Market for so long as such Notes are outstanding; *provided* that if at any time the Issuer determines that it will not maintain such listing, it will obtain prior to the delisting of the Notes from the Euro MTF Market of the Luxembourg Stock Exchange, and thereafter use its best efforts to maintain, a listing of such Notes on another recognized stock exchange.

Reports

For so long as any Notes are outstanding, Altice International will provide to the Trustee the following reports:

- (1) within 120 days after the end of Altice International’s fiscal year beginning with the fiscal year ending December 31, 2014, annual reports containing, to the extent applicable, and in a level of detail that is comparable in all material respects to the annual report of Altice International for the year ended December 31, 2013, the following information: audited consolidated balance sheet of Altice International as of the end of the most recent fiscal year (and comparative information as of the end of the prior fiscal year) and audited

consolidated income statements and statements of cash flow of Altice International for the most recent fiscal year (and comparative information as of the end of the prior fiscal year), including complete footnotes to such financial statements and the report of the independent auditors on the financial statements (*provided* that for any fiscal year ended prior to the Issue Date, Altice International can provide *pro forma* or aggregated financial statements prepared on a basis consistent with the *pro forma* information contained in “Pro Forma” section of this Offering Memorandum to meet the requirements set forth above); unaudited *pro forma* income statement information and balance sheet information of Altice International (which, for the avoidance of doubt, shall not include the provision of a full income statement or balance sheet to the extent not reasonably available), together with explanatory footnotes, for (i) any acquisition or disposition by Altice International or a Restricted Subsidiary that, individually or in the aggregate when considered with all other acquisitions or dispositions that have occurred since the beginning of the most recently completed fiscal year as to which such annual report relates, represent greater than 20% of the consolidated revenues, EBITDA, or assets of Altice International on a *pro forma* consolidated basis or (ii) recapitalizations by Altice International or a Restricted Subsidiary, in each case, that have occurred since the beginning of the most recently completed fiscal year (unless such *pro forma* information has been provided in a prior report pursuant to clause (2) or (3) below); (c) an operating and financial review of the audited financial statements, including a discussion of the results of operations, financial condition, and liquidity and capital resources of Altice International, and a discussion of material commitments and contingencies and critical accounting policies; (d) description of the business, management and shareholders of Altice International, all material affiliate transactions and a description of all material contractual arrangements, including material debt instruments; and (e) a description of material risk factors and material recent developments (to the extent not previously reported pursuant to clause (2) or (3) below).

- (2) within 60 days following the end of the first three fiscal quarters in each fiscal year of Altice International beginning with the fiscal quarter ending March 31, 2015 (*provided* that, if the Completion Date occurs in any such fiscal quarter, the foregoing reference to 60 days shall be deemed to be 90 days for such fiscal quarter), all quarterly reports of Altice International containing the following information in a level of detail comparable in all material respects to the quarterly report of Altice International for the nine months ended September 30, 2014: (a) an unaudited condensed consolidated balance sheet as of the end of such quarter and unaudited condensed consolidated statements of income and cash flow for the most recent quarter year-to-date period ending on the date of the unaudited condensed balance sheet, and the comparable prior year periods, together with condensed footnote disclosure; (b) unaudited *pro forma* income statement information and balance sheet information (which, for the avoidance of doubt, shall not include the provision of a full income statement or balance sheet to the extent not reasonably available), together with explanatory footnotes, for any acquisition or disposition by Altice International or a Restricted Subsidiary that, individually or in the aggregate when considered with all other acquisitions or dispositions that have occurred since the beginning of the relevant quarter, represent greater than 20% of the consolidated revenues, EBITDA, or assets of Altice International on a *pro forma* consolidated basis (unless such *pro forma* information has been provided in a prior report pursuant to clause (3) below); (c) a summary operating and financial review of the unaudited financial statements, including a discussion of revenues, EBITDA, capital expenditures, operating cash flow, and material changes in liquidity and capital resources, and a discussion of material changes not in the ordinary course of business in commitments and contingencies since the most recent report; and (d) material recent developments (to the extent not previously reported pursuant to clause (3) below); and
- (3) promptly after the occurrence of such event, information with respect to (a) any change in the independent public accountants of Altice International, (b) any material acquisition, disposal, merger or similar transaction or (c) any development determined by an Officer of Altice International to be material to the business of Altice International and its Restricted Subsidiaries (taken as a whole).

All financial statement information shall be prepared in accordance with IFRS as in effect on the date of such report or financial statement (or otherwise on the basis of IFRS as then in effect) and on a consistent basis for the periods presented; *provided, however*, that the reports set forth in clauses (1), (2) and (3) above may in the event of a change in IFRS, present earlier periods on a basis that applied to such periods. Except as provided for above, no report need include separate financial statements for Altice International or Subsidiaries of Altice International or any disclosure with respect to the results of operations or any other financial or statistical disclosure not of a type included in the Offering Memorandum and in no event shall U.S. GAAP information or reconciliation to U.S. GAAP be required.

At any time if any Subsidiary of Altice International is an Unrestricted Subsidiary and any such Unrestricted Subsidiary or group of Unrestricted Subsidiaries, if taken together as one Subsidiary, constitutes a Significant Subsidiary, then the quarterly and annual financial information required by the first paragraph of this covenant will include a reasonably detailed presentation, either on the face of the financial statements or in the footnotes thereto, of the financial condition and results of operations of Altice International and its Restricted Subsidiaries separate from the financial condition and results of operations of the Unrestricted Subsidiaries of Altice International.

Substantially concurrently with the issuance to the Trustee of the reports specified in (1), (2) and (3) of the first paragraph of this covenant, Altice International shall also (a) use its commercially reasonable efforts (i) to post copies of such reports on such website as may be then maintained by the Issuer, Altice International and its Subsidiaries or (ii) otherwise to provide substantially comparable public availability of such reports (as determined by Altice International in good faith) or (b) to the extent Altice International determines in good faith that such reports cannot be made available in the manner described in the preceding clause (a) owing to applicable law or after the use of its commercially reasonable efforts, furnish such reports to the Holders and, upon their request, prospective purchasers of the Notes. Altice International will also make available copies of all reports required by clauses (1) through (3) of the first paragraph of this covenant, if and so long as the Notes are listed on the Euro MTF Market of the Luxembourg Stock Exchange and the rules of the Luxembourg Stock Exchange so require, at the Issuer's registered office in Luxembourg or, to the extent and in the manner permitted by such rules, post such reports on the official website of the Luxembourg Stock Exchange (www.bourse.lu).

In addition, so long as the Notes remain outstanding and during any period during which the Issuer is not subject to Section 13 or 15(d) of the Exchange Act nor exempt therefrom pursuant to Rule 12g3-2(b), the Issuer shall furnish to the Holders and holders of beneficial interests in the Notes and, upon their request, prospective purchasers of the Notes or prospective and purchasers of beneficial interests in the Notes, the information required to be delivered pursuant to Rule 144A(d)(4) under the Securities Act.

Merger and Consolidation

The Issuer

The Issuer will not directly or indirectly: (1) consolidate or merge with or into another Person (whether or not the Issuer is the surviving corporation), or (2) sell, assign, transfer, lease, convey or otherwise dispose of all or substantially all of the properties or assets of the Issuer taken as a whole in one or more related transactions, to another Person.

Altice International

Altice International will not consolidate with or merge with or into, or assign, convey, transfer, lease or otherwise dispose all or substantially all its assets as an entirety or substantially as an entirety, in one transaction or a series of related transactions to, any Person, unless:

- (1) the resulting, surviving or transferee Person (the "*Successor Company*") (if not Altice International) will be a Person organized and existing under the laws of any member state of the European Union, Switzerland, Canada, the State of Israel or the United States of America, any State of the United States or the District of Columbia and the Successor Company (if not Altice International) will expressly assume, (a) by supplemental indenture, executed and delivered to the Trustee, in form reasonably satisfactory to the Trustee, all the obligations of Altice International under the Notes and the Indenture and (b) all obligations of Altice International under the Intercreditor Agreement and the Security Documents, as applicable;
- (2) immediately after giving effect to such transaction (and treating any Indebtedness that becomes an obligation of the Successor Company or any Subsidiary of the Successor Company as a result of such transaction as having been incurred by the Successor Company or such Subsidiary at the time of such transaction), no Default or Event of Default shall have occurred and be continuing;
- (3) immediately after giving *pro forma* effect to such transaction and any related financing transactions, as if such transactions had occurred at the beginning of applicable four-quarter period, either (a) the Issuer and the Guarantors would have been able to Guarantee € 1.00 of in additional Indebtedness of HoldCo pursuant to clause (15) of the second paragraph of the covenant described under "*—Limitation on Indebtedness*"; or (b) the Consolidated Net Leverage Ratio would not be greater than it was immediately prior to giving effect to such transaction; and
- (4) the Issuer shall have delivered to the Trustee an Officer's Certificate and an Opinion of Counsel, each to the effect that such consolidation, merger or transfer and such supplemental indenture (if any) comply with the Indenture and an Opinion of Counsel to the effect that such supplemental indenture (if any) has been duly authorized, executed and delivered and is a legal, valid and binding agreement enforceable against the Successor Company (in each case, in form and substance reasonably satisfactory to the Trustee); *provided* that in giving an Opinion of Counsel, counsel may rely on an Officer's Certificate as to any matters of fact.

Subject to the fourth paragraph of the covenant "*Merger and Consolidation—OMT Proceeds Loan Obligors*", for purposes of this covenant, the sale, lease, conveyance, assignment, transfer, or other disposition of all or substantially all of the properties and assets of one or more Subsidiaries of Altice International, which properties and assets, if held by

Altice International instead of such Subsidiaries, would constitute all or substantially all of the properties and assets of Altice International on a consolidated basis, shall be deemed to be the transfer of all or substantially all of the properties and assets of Altice International.

The Successor Company will succeed to, and be substituted for, and may exercise every right and power of, Altice International under the Indenture but in the case of a lease of all or substantially all its assets, the predecessor company will not be released from its obligations under the Indenture or the Notes.

Notwithstanding the preceding clauses (2) and (3) (which do not apply to transactions referred to in this sentence) and clause (4) of the second paragraph of this covenant (which does not apply to transactions referred to in this sentence in which Altice International is the Successor Company), (a) any Restricted Subsidiary may consolidate or otherwise combine with, merge into or transfer all or part of its properties and assets to Altice International (so long as Altice International is a Guarantor); and (b) any Restricted Subsidiary that is not a Guarantor may consolidate or otherwise combine with, merge into or transfer all or part of its properties and assets to any other Restricted Subsidiary or Altice International. Notwithstanding the preceding clause (3) (which does not apply to the transactions referred to in this sentence) of the second paragraph of this covenant, Altice International may consolidate or otherwise combine with or merge into an Affiliate incorporated or organized for the purpose of changing the legal domicile of Altice International, reincorporating Altice International in another jurisdiction or changing the legal form of Altice International.

There is no precise established definition of the phrase “substantially all” under applicable law. Accordingly, in certain circumstances there may be a degree of uncertainty as to whether a particular transaction would involve “all or substantially all” of the property or assets of a Person.

The foregoing provisions (other than the requirements of clause (2) of the second paragraph of this “Merger and Consolidation” covenant) shall not apply to the creation of a new Subsidiary as a Restricted Subsidiary.

The Subsidiary Guarantors

None of the Subsidiary Guarantors (other than a Guarantor whose Note Guarantee is to be released in accordance with the terms of the Indenture or the Intercreditor Agreement) may:

- (1) consolidate with or merge with or into any Person (whether or not such Guarantor is the surviving Person);
- (2) sell, assign, convey, transfer, lease or otherwise dispose of, all or substantially all its assets as an entirety or substantially as an entirety, in one transaction or a series of related transactions, to any Person; or
- (3) permit any Person to merge with or into it;

unless:

- (A) the other Person is Altice International or a Restricted Subsidiary that is a Guarantor or becomes a Guarantor as a result of such transaction; or
- (B) (1) either (x) a Guarantor is the surviving Person or (y) the resulting, surviving or transferee Person expressly assumes all of the obligations of the Guarantor under its Note Guarantee and the Indenture (pursuant to a supplemental indenture executed and delivered in a form reasonably satisfactory to the Trustee) and all obligations of the Guarantor under the Intercreditor Agreement and Security Documents, as applicable; and
(2) immediately after giving effect to the transaction, no Default or Event of Default shall have occurred and is continuing; or
- (C) the transaction constitutes a sale or other disposition (including by way of consolidation or merger) of a Guarantor or the sale or disposition of all or substantially all the assets of a Guarantor (in each case other than to Altice International or a Restricted Subsidiary) otherwise permitted by the Indenture and the proceeds therefrom are applied as required by the Indenture.

Notwithstanding the preceding clause (B)(2) (which does not apply to transactions referred to in this sentence), (a) any Restricted Subsidiary may consolidate or otherwise combine with, merge into or transfer all or part of its properties and assets to a Guarantor and (b) any Guarantor may consolidate or otherwise combine with, merge into or transfer all or part of its properties and assets to any other Guarantor. Notwithstanding the preceding clause (B)(2) (which does not apply to the transactions referred to in this sentence), a Guarantor may consolidate or otherwise combine with or merge into an

Affiliate incorporated or organized for the purpose of changing the legal domicile of the Guarantor reincorporating the Guarantor in another jurisdiction, or changing the legal form of the Guarantor.

The HOT Proceeds Note Obligors

Prior to the HOT Direct Obligation Event, none of the HOT Proceeds Note Obligors (other than a HOT Proceeds Note Guarantor whose HOT Proceeds Note Guarantee is to be released in accordance with the terms of the Indenture and the HOT Proceeds Note) may:

- (1) consolidate with or merge with or into any Person (whether or not such HOT Proceeds Note Obligor is the surviving Person);
- (2) sell, assign, convey, transfer, lease or otherwise dispose of, all or substantially all its assets as an entirety or substantially as an entirety, in one transaction or a series of related transactions, to any Person; or
- (3) permit any Person to merge with or into it;

unless:

- (A) the other Person is HOT, Altice International, a Restricted Subsidiary that is a Guarantor or becomes a Guarantor as a result of such transaction or a Restricted Subsidiary that is a HOT Proceeds Note Guarantor or becomes a HOT Proceeds Note Guarantor as a result of such transaction; or
- (B) (1) either (x) a HOT Proceeds Note Obligor is the surviving Person or (y) the resulting, surviving or transferee Person expressly assumes all of the obligations of the HOT Proceeds Note Obligor under its HOT Proceeds Note Guarantee and the HOT Proceeds Note and all obligations of the HOT Proceeds Note Obligor under the HOT Security Documents, as applicable; and
 - (2) immediately after giving effect to the transaction, no Default or Event of Default shall have occurred and is continuing and default or event of default under the HOT Proceeds Note or the Indenture shall have occurred and is continuing; or
- (C) the transaction constitutes a sale or other disposition (including by way of consolidation or merger) of a HOT Proceeds Note Obligor or the sale or disposition of all or substantially all the assets of a HOT Proceeds Note Obligor (in each case other than to Altice International or a Restricted Subsidiary) otherwise permitted by the Indenture and the proceeds therefrom are applied as required by the Indenture.

Notwithstanding the preceding clause (B)(2) (which does not apply to transactions referred to in this sentence), (a) any Subsidiary of HOT that is a Restricted Subsidiary may consolidate or otherwise combine with, merge into or transfer all or part of its properties and assets to a HOT Proceeds Note Obligor, (b) any HOT Proceeds Note Obligor may consolidate or otherwise combine with, merge into or transfer all or part of its properties and assets to any other HOT Proceeds Note Obligor, and (c) HOT may consolidate or otherwise combine with, merge into or transfer all or part of its properties and assets to any HOT Proceeds Note Guarantor. Notwithstanding the preceding clause (B)(2) (which does not apply to the transactions referred to in this sentence), a HOT Proceeds Note Obligor may consolidate or otherwise combine with or merge into an Affiliate incorporated or organized for the purpose of changing the legal domicile of the HOT Proceeds Note Obligor, reincorporating the HOT Proceeds Note Obligor in another jurisdiction, or changing the legal form of the HOT Proceeds Note Obligor.

There is no precise established definition of the phrase “substantially all” under applicable law. Accordingly, in certain circumstances there may be a degree of uncertainty as to whether a particular transaction would involve “all or substantially all” of the property or assets of a Person.

OMT Proceeds Loan Obligors

Prior to the OMT Direct Obligation Event, none of the OMT Proceeds Loan Obligors may:

- (1) consolidate with or merge with or into any Person (whether or not such OMT Proceeds Loan Obligor is the surviving Person);
- (2) sell, assign, convey, transfer, lease or otherwise dispose of, all or substantially all its assets as an entirety or substantially as an entirety, in one transaction or a series of related transactions, to any Person; or

(3) permit any Person to merge with or into it;

unless:

- (A) the other Person is Altice International, a Restricted Subsidiary that is a Guarantor or becomes a Guarantor as a result of such transaction or a Restricted Subsidiary that is an OMT Proceeds Loan Obligor or becomes an OMT Proceeds Loan Obligor as a result of such transaction; or
- (B) (1) either (x) an OMT Proceeds Loan Obligor is the surviving Person or (y) the resulting, surviving or transferee Person expressly assumes all of the obligations of the OMT Proceeds Loan Obligor under the OMT Proceeds Loan (or Guarantee thereof (as applicable)) and all obligations of the OMT Proceeds Loan Obligor under the OMT Security Documents, as applicable; and
- (2) immediately after giving effect to the transaction, no Default or Event of Default shall have occurred and is continuing and default or event of default under the OMT Proceeds Loan or the Indenture shall have occurred and is continuing; or
- (C) the transaction constitutes a sale or other disposition (including by way of consolidation or merger) of an OMT Proceeds Loan Obligor or the sale or disposition of all or substantially all the assets of an OMT Proceeds Loan Obligor (in each case other than to Altice International or a Restricted Subsidiary) otherwise permitted by the Indenture and the proceeds therefrom are applied as required by the Indenture.

Notwithstanding the preceding clause (B)(2) (which does not apply to transactions referred to in this sentence), (a) any Subsidiary of OMT that is a Restricted Subsidiary may consolidate or otherwise combine with, merge into or transfer all or part of its properties and assets to an OMT Proceeds Loan Obligor and (b) any OMT Proceeds Loan Obligor may consolidate or otherwise combine with, merge into or transfer all or part of its properties and assets to any other OMT Proceeds Loan Obligor. Notwithstanding the preceding clause (B)(2) (which does not apply to the transactions referred to in this sentence), an OMT Proceeds Loan Obligor may consolidate or otherwise combine with or merge into an Affiliate incorporated or organized for the purpose of changing the legal domicile of the OMT Proceeds Loan Obligor reincorporating the OMT Proceeds Loan Obligor in another jurisdiction, or changing the legal form of the OMT Proceeds Loan Obligor.

There is no precise established definition of the phrase “substantially all” under applicable law. Accordingly, in certain circumstances there may be a degree of uncertainty as to whether a particular transaction would involve “all or substantially all” of the property or assets of a Person.

The provisions under this covenant “*Merger and Consolidation—Altice International*”, “*Merger and Consolidation—The Subsidiary Guarantors*”, “*Merger and Consolidation—The HOT Proceeds Note Obligors*” and “*Merger and Consolidation—OMT Proceeds Notes Obligors*” shall not apply to (1) any sale, lease, transfer, conveyance or other disposition in one or a series of related transactions of any assets of Altice International and its Subsidiaries or the Target and its Subsidiaries (including the Capital Stock of the Target or any Subsidiary of Altice International or the Target) that is required pursuant to Competition Laws in relation to the Acquisition or is taken to avoid or eliminate any impediment under Competition Laws in relation to the Acquisition (including, without limitation, in response to any actions initiated by an administrative, regulatory or other governmental authority or private party under Competition Laws); *provided* that, solely to the extent Altice International is relying on the foregoing exception, in the event the fair market value of any such sold, leased, transferred, conveyed or disposed of assets exceeds 2.0% of the Total Assets (on a pro forma consolidated basis, including, without limitation, the Target and its Subsidiaries that are Restricted Subsidiaries), (i) the Consolidated Net Leverage Ratio of Altice International and its Restricted Subsidiaries (on a pro forma consolidated basis, including, without limitation, the Target and its Subsidiaries that are Restricted Subsidiaries) shall not increase; and (ii) Altice International shall promptly make an offer to all holders of the Existing Term Loans and, to the extent required by the terms of any Pari Passu Indebtedness that is not Public Debt, any such Pari Passu Indebtedness to repay or repurchase such Existing Term Loans and Pari Passu Indebtedness at a price of 100% of the principal amount thereof plus accrued and unpaid interest thereon to the date of redemption in an amount equal to the Net Cash Proceeds of such sale, lease, transfer, conveyance or other disposition (on a *pro rata* basis on the basis of the aggregate principal amount of tendered Existing Term Loans and Pari Passu Indebtedness) and in the event the principal amount of such Pari Passu Indebtedness tendered is less than the amount of such Net Cash Proceeds, Altice International shall apply any such remaining proceeds to prepay an equal principal amount of Existing Term Loans at par on a pro rata basis. There is no precise established definition of the phrase “substantially all” under applicable law. Accordingly, in certain circumstances there may be a degree of uncertainty as to whether a particular transaction would involve “all or substantially all” of the property or assets of a Person.

Limitation on Issuer Activities

Notwithstanding anything contained in the Indenture:

- (1) The Issuer will not engage in any business activity or undertake any other activity, except any such activity:
 - (a) reasonably relating to the offering, sale, issuance, Incurrence, servicing, purchase, redemption, amendment, exchange, refinancing or retirement of or Investment in the, Notes, the Existing Senior Secured Notes, the Senior Credit Facilities, the Revolving Credit Facilities, the Guarantee Facility, any Additional Notes or other Indebtedness (including any Refinancing Indebtedness in respect of any of the foregoing) permitted to be Incurred by the terms of the Indenture (including the lending, directly or indirectly, of the proceeds of such sale of the Notes, any Additional Notes or other Indebtedness permitted by the terms of the Indenture pursuant to Issuer Proceeds Loans or borrowing, directly or indirectly, from Altice International or any Restricted Subsidiary);
 - (b) undertaken with the purpose of, directly or indirectly, fulfilling its obligations or exercising its rights under the Notes, the Existing Senior Secured Notes, the Senior Credit Facilities, the Revolving Credit Facilities, the Guarantee Facility, any Additional Notes, any Issuer Proceeds Loan, any Additional Notes or other Indebtedness, Hedging Obligations or any other obligations (including any Refinancing Indebtedness in respect of any of the foregoing), in each case, permitted to be Incurred by the terms of the Indenture, the Existing Senior Secured Notes Indentures, the New Senior Notes Indenture, the Existing Senior Notes Indentures, any Security Document to which it is a party, the Intercreditor Agreement (or any Additional Intercreditor Agreement entered into pursuant to the terms of the Intercreditor Agreement or the Indenture) or the Notes Escrow Agreement;
 - (c) directly related or reasonably incidental to the establishment and/or maintenance of the Issuer's corporate existence, the acquisition, holding or disposition of assets permitted to be held by it under the Indenture, the Existing Senior Secured Notes Indentures, the New Senior Notes Indenture and the Existing Senior Notes Indentures;
 - (d) directly related to investing amounts received by the Issuer (other than amounts not corresponding to required payments under the Notes) in such manner not otherwise prohibited by the Indenture;
 - (e) making Permitted Issuer Investments and Incurring Permitted Issuer Liens;
 - (f) related to cash management activities on behalf of Altice International and the Restricted Subsidiaries; or
 - (g) (i) any transaction or activity not to exceed €5 million in the aggregate and (ii) other activities not specifically enumerated above that are immaterial in nature.
- (2) The Issuer shall not:
 - (a) issue any Capital Stock (other than to HoldCo);
 - (b) take any action which would cause it to no longer satisfy the requirements of an available exemption from the provisions of the U.S. Investment Company Act of 1940, as amended;
 - (c) commence or take any action or facilitate a winding-up, liquidation, dissolution or other analogous proceeding;
 - (d) amend its constitutive documents in any manner which would adversely affect the rights of Holders in any material respect;
 - (e) transfer or assign any Issuer Proceeds Loan (or rights thereunder) except pursuant to the Notes Security Documents; or
 - (f) amend any provision of, or waive any default or event of default under, any Issuer Proceeds Loan except in accordance with "*—Amendments and Waivers*".

- (3) Except as otherwise provided in the Indenture, the Issuer will take all actions necessary and within its power to prohibit the transfer of the issued ordinary shares and management share in the Issuer by HoldCo, other than pursuant to the Issuer Share Pledge or the enforcement of such Issuer Share Pledge.
- (4) Whenever the Issuer receives a payment or prepayment under any Issuer Proceeds Loan, it shall use the funds received to satisfy its obligations (to the extent of the amount owing in respect of such obligations) under the Indenture (including any premium paid to holders of the Notes), the Existing Senior Secured Notes Indentures or any other Indebtedness of the Issuer; *provided* that to the extent the Issuer receives cash payment in respect of interest on an Issuer Proceeds Loan previously paid in-kind and the amount of such cash payment exceeds the obligations then due and payable (or due and payable within five Business Days of such receipt) under the Notes or any other Indebtedness of the Issuer, the Issuer may use such excess amount for any purpose not prohibited by the Indenture.

Altice International will not permit HoldCo or the Issuer or become a direct or indirect subsidiary of any other subsidiary (other than HoldCo).

Lines of Business

Altice International will not and will not permit any of its Restricted Subsidiaries to, engage in any business other than a Similar Business, except to such extent as would not be material to Altice International and the Restricted Subsidiaries, taken as a whole.

Additional Guarantors

Altice International will not permit any of its Restricted Subsidiaries (other than a Guarantor) to, Guarantee any Indebtedness of the Issuer or any Guarantor (other than Indebtedness Incurred under clause (8) of the second paragraph of the covenant described under “—*Limitation on Indebtedness*”, except Indebtedness Incurred under Credit Facilities or Public Debt pursuant to such clause (8)) unless such Restricted Subsidiary is or becomes a Guarantor on the date on which the Guarantee is Incurred and, if applicable, executes and delivers to the Trustee a supplemental indenture in the form attached to the Indenture pursuant to which such Restricted Subsidiary will provide a Note Guarantee, which Guarantee will be senior to or pari passu with such Restricted Subsidiary’s Guarantee of such other Indebtedness.

HOT will not permit any of its Restricted Subsidiaries (other than a HOT Proceeds Note Guarantor) to, Guarantee any Indebtedness of HOT or any HOT Proceeds Note Guarantor (other than Indebtedness Incurred under clause (8) of the second paragraph of the covenant described under “—*Limitation on Indebtedness*”, except Indebtedness Incurred under Credit Facilities or Public Debt pursuant to such clause (8)) unless such Restricted Subsidiary is or becomes a HOT Proceeds Note Guarantor on the date on which the Guarantee is Incurred and, if applicable, accedes to each HOT Proceeds Note and becomes a HOT Proceeds Note Guarantor and guarantees the obligations of HOT under the HOT Proceeds Note, which Guarantee will be senior to or pari passu with such Restricted Subsidiary’s Guarantee of such other Indebtedness. HOT will not Guarantee any Indebtedness of any of its Restricted Subsidiaries (other than a HOT Proceeds Note Guarantor) (other than Indebtedness Incurred under clause (8) of the second paragraph of the covenant described under “—*Limitation on Indebtedness*”, except Indebtedness Incurred under Credit Facilities or Public Debt pursuant to such clause (8)) unless such Guarantee is pari passu or junior to the obligations of HOT under the HOT Proceeds Note.

Altice International will not permit any Subsidiary of NewCo OMT that are Restricted Subsidiaries (other than an OMT Proceeds Loan Obligor) to, Guarantee any Indebtedness of NewCo OMT or any other OMT Proceeds Loan Obligor (other than Indebtedness Incurred under clause (8) of the second paragraph of the covenant described under “—*Limitation on Indebtedness*”, except Indebtedness Incurred under Credit Facilities or Public Debt pursuant to such clause (8)) unless such Subsidiary of NewCo OMT Guarantees the OMT Proceeds Loan of NewCo OMT on the date on which the Guarantee is Incurred and, if applicable, accedes to such OMT Proceeds Loan and become an OMT Proceeds Loan Obligor and guarantees the obligations of NewCo OMT under the applicable OMT Proceeds Loan, which Guarantee will be senior to or pari passu with such Restricted Subsidiary’s Guarantee of such other Indebtedness.

Note Guarantees and HOT Proceeds Note Guarantees existing on or granted after the Issue Date pursuant to this covenant shall be released as set forth under “—*Releases of the Note Guarantees*” and “—*Releases of the HOT Proceeds Note Guarantees*”. Note Guarantees, HOT Proceeds Note Guarantees and OMT Proceeds Loan Guarantees (as applicable) existing on or granted after the Issue Date pursuant to the first, second and third paragraphs of this covenant may be released at the option of the Issuer, HOT or NewCo OMT, as the case may be, if, at the date of such release, (i) the Indebtedness which required such Note Guarantee, HOT Proceeds Note Guarantee or OMT Proceeds Loan Guarantee, as the case may be, has been released or discharged in full, (ii) no Event of Default would arise as a result of such release, and (iii) there is no other Indebtedness of such Guarantor, HOT Proceeds Note Guarantor or OMT Proceeds Loan Guarantor, as the case may be, outstanding that was Incurred after the Issue Date and that could not have been Incurred in compliance with the Indenture as of the date Incurred if such Guarantor, HOT Proceeds Note Guarantor or

OMT Proceeds Loan Guarantor were not a Guarantor, a HOT Proceeds Note Guarantor or OMT Proceeds Loan Guarantor, as the case may be, as at that date. The Trustee and the Security Agent (to the extent action is required by it) shall each take all necessary actions requested by the Issuer, including the granting of releases or waivers under the Intercreditor Agreement or any Additional Intercreditor Agreement, to effectuate any release of a Note Guarantee, HOT Proceeds Note Guarantee or OMT Proceeds Loan Guarantee in accordance with these provisions, subject to customary protections and indemnifications.

Each additional Note Guarantee, HOT Proceeds Note Guarantee and OMT Proceeds Loan Guarantee will be limited as necessary to recognize certain defenses generally available to guarantors (including those that relate to fraudulent conveyance or transfer, voidable preference, financial assistance, corporate purpose, thin capitalization, distributable reserves, capital maintenance or similar laws, regulations or defenses affecting the rights of creditors generally) or other considerations under applicable law.

Notwithstanding the foregoing, Altice International shall not be obligated to cause any Restricted Subsidiary, HOT will not be required to cause any of its Restricted Subsidiaries and NewCo OMT will not be required to cause any of its Restricted Subsidiaries to provide a Note Guarantee to the extent and for so long as the Incurrence of such Guarantee could reasonably be expected to give rise to or result in: (1) any violation of applicable law or regulation; (2) any liability for the officers, directors or (except in the case of a Restricted Subsidiary that is a partnership) shareholders of such Restricted Subsidiary (or, in the case of a Restricted Subsidiary that is a partnership, directors or shareholders of the partners of such partnership); (3) any cost, expense, liability or obligation (including with respect to any Taxes) other than reasonable out-of-pocket expenses and other than reasonable expenses incurred in connection with any governmental or regulatory filings required as a result of, or any measures pursuant to clause (1) of this paragraph undertaken in connection with, such Guarantee, which in any case under any of clauses (1), (2) and (3) of this paragraph cannot be avoided through measures reasonably available to Altice International, HOT, NewCo OMT or such Restricted Subsidiary; or (4) such Restricted Subsidiary is prohibited from incurring such Guarantee by the terms of any Indebtedness of such Restricted Subsidiary that is not prepayable without a prepayment premium (in each case, other than Indebtedness Incurred to provide all or any portion of the funds utilized to consummate the transaction or series of related transactions pursuant to which such Person became a Restricted Subsidiary); provided that this clause (4) applies only for so long as such prepayment premium applies to such Indebtedness.

Suspension of Covenants on Achievement of Investment Grade Status

If on any date following the Issue Date, the Notes have achieved Investment Grade Status and no Default or Event of Default has occurred and is continuing (a "Suspension Event"), then, the Issuer shall notify the Trustee of these events and beginning on that day and continuing until such time, if any, at which the Notes cease to have Investment Grade Status (the "Reversion Date"), the provisions of the Indenture summarized under the following captions will not apply to the Notes: "*—Limitation on Indebtedness*", "*—Limitation on Restricted Payments*", "*—Limitation on Restrictions on Distributions from Restricted Subsidiaries*", "*—Limitation on Sales of Assets and Subsidiary Stock*", "*—Limitation on Affiliate Transactions*" and "*—Impairment of Security Interests*", the provisions of clause (3) of the first paragraph of the covenant described under "*—Merger and Consolidation—Altice International*", and any related default provision of the Indenture will cease to be effective and will not be applicable to Altice International and the Restricted Subsidiaries. Such covenants and any related default provisions will again apply according to their terms from the first day on which a Suspension Event ceases to be in effect. Such covenants will not, however, be of any effect with regard to actions of the Issuer properly taken during the continuance of the Suspension Event, and the "*—Limitation on Restricted Payments*" covenant will be interpreted as if it has been in effect since the date of the Indenture except that no Default will be deemed to have occurred solely by reason of a Restricted Payment made while that covenant was suspended. On the Reversion Date, all Indebtedness Incurred during the continuance of the Suspension Event will be classified, at the Issuer's option, as having been Incurred pursuant to the first paragraph of the covenant described under "*—Limitation on Indebtedness*" or one of the clauses set forth in the second paragraph of such covenant (to the extent such Indebtedness would be permitted to be Incurred thereunder as of the Reversion Date and after giving effect to Indebtedness Incurred prior to the Suspension Event and outstanding on the Reversion Date). To the extent such Indebtedness would not be so permitted to be Incurred under the first two paragraphs of the covenant described under "*—Limitation on Indebtedness*", such Indebtedness will be deemed to have been outstanding on the Issue Date, so that it is classified as permitted under clause (4)(b) of the second paragraph of the covenant described under "*—Limitation on Indebtedness*".

Impairment of Security Interests

Altice International shall not and shall not permit any Restricted Subsidiary to, take or omit to take any action that would have the result of materially impairing the security interest with respect to the Notes Collateral (it being understood that the Incurrence of Permitted Collateral Liens, subject to the proviso in the second sentence of the next succeeding paragraph, shall under no circumstances be deemed to materially impair the security interest with respect to the Notes Collateral) for the benefit of the Trustee and the Holders, and Altice International shall not and shall not permit any Restricted Subsidiary to, grant to any Person other than the Security Agent (or its delegate), for the benefit of the Trustee

and the Holders and the other beneficiaries described in the Security Documents, the Intercreditor Agreement or any Additional Intercreditor Agreement, any Lien over any of the Notes Collateral; *provided*, that, subject to the proviso in the second sentence of the next succeeding paragraph, (x) Altice International and the Restricted Subsidiaries may Incur Permitted Collateral Liens, (y) the Notes Collateral may be discharged, amended, extended, renewed, restated, supplemented, released, modified or replaced in accordance with the Indenture, the Intercreditor Agreement, any Additional Intercreditor Agreement or the applicable Security Documents and (z) Altice International and the Restricted Subsidiaries may consummate any other transaction permitted under “—*Merger and Consolidation*”.

Notwithstanding the above, nothing in this covenant shall restrict the discharge and release of any Lien over the Notes Collateral in accordance with the Indenture, the Intercreditor Agreement or any Additional Intercreditor Agreement. Subject to the foregoing, the Security Documents may be amended, extended, renewed, restated, supplemented or otherwise modified or released (followed by an immediate retaking of a Lien of at least equivalent ranking over the same assets) to (i) cure any ambiguity, omission, defect or inconsistency therein; (ii) provide for Permitted Collateral Liens; (iii) make any change reasonably necessary or desirable in the good faith determination of the Issuer in order to implement transactions permitted under “—*Merger and Consolidation*,” (iv) add to the Notes Collateral; (v) provide for the release of any Lien on any properties or assets constituting Notes Collateral from the Lien of the Security Documents; *provided that* such release is followed by the substantially concurrent re-taking of a Lien of at least equivalent priority over the same properties and assets securing the Notes or any Note Guarantee; or (vi) make any other change thereto that does not adversely affect the Holders in any material respect; *provided*, however, that, contemporaneously with any such action in clauses (ii), (iii), (iv), (v), and (vi) the Issuer delivers to the Trustee, either (1) a solvency opinion, in form and substance reasonably satisfactory to the Trustee, from an independent financial advisor or appraiser or investment bank of international standing which confirms the solvency of Altice International and its Subsidiaries, taken as a whole, after giving effect to any transactions related to such amendment, extension, renewal, restatement, supplement, modification or replacement, (2) a certificate from the chief financial officer or the Board of Directors of the relevant Person which confirms the solvency of the Person granting the Lien after giving effect to any transactions related to such amendment, extension, renewal, restatement, supplement, modification or replacement, or (3) an opinion of counsel (subject to any qualifications customary for this type of opinion of counsel), in form and substance reasonably satisfactory to the Trustee, confirming that, after giving effect to any transactions related to such amendment, extension, renewal, restatement, supplement, modification or replacement, the Lien or Liens created under the Security Documents so amended, extended, renewed, restated, supplemented, modified or replaced are valid Liens not otherwise subject to any limitation, imperfection or new hardening period, in equity or at law, that such Lien or Liens were not otherwise subject to immediately prior to such amendment, extension, renewal, restatement, supplement, modification or replacement.

Altice International shall not and shall not permit any Restricted Subsidiary to, take or omit to take any action that would have the result of materially impairing the security interest with respect to the HOT Proceeds Note Collateral or the OMT Proceeds Loans Collateral (it being understood that the Incurrence of Permitted HOT Proceeds Note Collateral Liens and Permitted OMT Proceeds Loans Collateral Liens, subject to the proviso in the second sentence of the next succeeding paragraph, shall under no circumstances be deemed to materially impair the security interest with respect to the HOT Proceeds Note Collateral or the OMT Proceeds Loans Collateral, as the case may be) for the benefit of the lenders under the HOT Proceeds Note or the OMT Proceeds Loan, as the case may be, and Altice International shall not and shall not permit any Restricted Subsidiary to, grant to any Person other than the Security Agent (or its delegate) any Lien over any of the HOT Proceeds Note Collateral or the OMT Proceeds Loans Collateral; *provided*, that, subject to the proviso in the second sentence of the next succeeding paragraph, (w) Altice International and the Restricted Subsidiaries may Incur Permitted HOT Proceeds Note Collateral Liens and Permitted OMT Proceeds Loans Collateral Liens, (x) the HOT Proceeds Note Collateral and the OMT Proceeds Loans Collateral may be discharged, amended, extended, renewed, restated, supplemented, released, modified or replaced in accordance with the HOT Proceeds Note, the applicable HOT Security Documents or the applicable OMT Security Documents, (y) Altice International and their Restricted Subsidiaries may consummate any other transaction permitted under “—*Merger and Consolidation*” and (z) Altice International and its Restricted Subsidiaries may consummate the HOT Direct Obligation Event and the OMT Direct Obligation Event.

Notwithstanding the above, nothing in this covenant shall restrict the discharge and release of any HOT Proceeds Note Security Interest or the OMT Proceeds Loans Security Interest in accordance with the Indenture, the Intercreditor Agreement or any Additional Intercreditor Agreement. Subject to the foregoing, the HOT Security Documents and the OMT Security Documents may be amended, extended, renewed, restated, supplemented or otherwise modified or released (followed by an immediate retaking of a Lien of at least equivalent ranking over the same assets) to (i) cure any ambiguity, omission, defect or inconsistency therein; (ii) provide for HOT Proceeds Note Permitted Collateral Liens or OMT Proceeds Loans Permitted Collateral Liens; (iii) make any change reasonably necessary in the good faith determination of the Issuer in order to implement transactions permitted under “—*Merger and Consolidation*,” (iv) add to the HOT Proceeds Note Collateral or OMT Proceeds Loans Collateral; (v) provide for the release of any HOT Proceeds Note Security Interest or any OMT Proceeds Loan Security Interest on any properties or assets constituting HOT Proceeds Note Collateral or OMT Proceeds Loans Collateral from the Lien of the HOT Security Documents or OMT Security Documents, as applicable; *provided that* such release is followed by the substantially concurrent re-taking

of a Lien of at least equivalent priority over the same properties and assets securing the HOT Proceeds Note, any HOT Proceeds Note Guarantee, or the OMT Proceeds Loan, as applicable; (vi) consummate a Direct Obligation Event or (vii) make any other change thereto that does not adversely affect the Holders or the Issuer in any material respect; *provided, however*, that, contemporaneously with any such action in clauses (ii), (iii), (iv), (v), (vi), and (vii) the Issuer delivers to the Trustee, either (1) a solvency opinion, in form and substance reasonably satisfactory to the Trustee, from an independent financial advisor or appraiser or investment bank of international standing which confirms the solvency of HOT and its Subsidiaries or NewCo OMT and its Subsidiaries, as the case may be, taken as a whole, after giving effect to any transactions related to such amendment, extension, renewal, restatement, supplement, modification or replacement, (2) a certificate from the chief financial officer or the Board of Directors of the relevant Person which confirms the solvency of the Person granting HOT Proceeds Note Security Interest or the OMT Proceeds Loan Security Interest, as the case may be, after giving effect to any transactions related to such amendment, extension, renewal, restatement, supplement, modification or replacement, or (3) an opinion of counsel (subject to any qualifications customary for this type of opinion of counsel), in form and substance reasonably satisfactory to the Trustee, confirming that, after giving effect to any transactions related to such amendment, extension, renewal, restatement, supplement, modification or replacement, the Lien or Liens created under the HOT Security Documents or the OMT Security Documents so amended, extended, renewed, restated, supplemented, modified or replaced are valid Liens not otherwise subject to any limitation, imperfection or new hardening period, in equity or at law, that such Lien or Liens were not otherwise subject to immediately prior to such amendment, extension, renewal, restatement, supplement, modification or replacement.

In the event that Altice International and the Restricted Subsidiaries comply with the requirements of this covenant, the Trustee and the Security Agent shall (subject to customary protections and indemnifications) consent to such amendments without the need for instructions from the Holders.

Payments for Consents

Altice International will not and will not permit any of its Restricted Subsidiaries to, directly or indirectly, pay or cause to be paid any consideration to or for the benefit of any Holder for or as an inducement to any consent, waiver or amendment of any of the terms of the provisions of the Indenture or the Notes unless such consideration is offered to be paid and is paid to all holders of Notes that consent, waive or agree to amend in the time frame set forth in the solicitation documents relating to such consent, waiver or agreement. Notwithstanding the foregoing, Altice International and the Restricted Subsidiaries shall be permitted, in any offer or payment of consideration for, or as an inducement to, any consent, waiver or amendment of any of the terms or provisions of the Indenture, to exclude holders of Notes in any jurisdiction where (i) the solicitation of such consent, waiver or amendment, including in connection with an exchange offer or an offer to purchase for cash, or (ii) the payment of the consideration therefor would require Altice International or any Restricted Subsidiary to file a registration statement, prospectus or similar document under any applicable securities laws (including, but not limited to, the United States federal securities laws and the laws of the European Union or its member states or the State of Israel), which the Issuer in its sole discretion determine (acting in good faith) (A) would be materially burdensome (it being understood that it would not be materially burdensome to file the consent document(s) used in other jurisdictions, any substantially similar documents or any summary thereof with the securities or financial services authorities in such jurisdiction) or (B) such solicitation would otherwise not be permitted under applicable law in such jurisdiction.

Additional Intercreditor Agreements

The Indenture provides that, at the request of the Issuer, in connection with the Incurrence by Altice International or a Restricted Subsidiary of any Indebtedness that is permitted to share the Notes Collateral pursuant to the definition of Permitted Collateral Liens, Altice International or a Restricted Subsidiary, the Trustee and the Security Agent shall enter into with the holders of such Indebtedness (or their duly authorized Representatives) an intercreditor agreement (an "Additional Intercreditor Agreement") or a restatement, amendment or other modification of the existing Intercreditor Agreement on substantially the same terms as the Intercreditor Agreement (or terms not materially less favorable to the Holders), including containing substantially the same terms with respect to release of Note Guarantees and priority and release of the Liens over the Notes Collateral (or terms not materially less favorable to the Holders); *provided* that such Additional Intercreditor Agreement will not impose any personal obligations on the Trustee or Security Agent or, in the opinion of the Trustee or Security Agent, as applicable, adversely affect the rights, duties, liabilities or immunities of the Trustee or Security Agent under the Indenture or the Intercreditor Agreement. For the avoidance of doubt, subject to the foregoing and the succeeding paragraph, any such Additional Intercreditor Agreement may provide for *pari passu* or subordinated security interests in respect of any such Indebtedness (to the extent such Indebtedness is permitted to share the Notes Collateral pursuant to the definition of Permitted Collateral Lien).

The Indenture also provides that, at the direction of the Issuer and without the consent of Holders, the Trustee and the Security Agent shall from time to time enter into one or more amendments to any Intercreditor Agreement to: (1) cure any ambiguity, omission, defect or inconsistency of any such agreement, (2) increase the amount or types of

Indebtedness covered by any such agreement that may be Incurred by the Issuer or a Guarantor that is subject to any such agreement (including with respect to any Intercreditor Agreement or Additional Intercreditor Agreement, the addition of provisions relating to new Indebtedness ranking junior in right of payment to the Notes), (3) add Restricted Subsidiaries to the Intercreditor Agreement or an Additional Intercreditor Agreement, (4) further secure the Notes (including Additional Notes), (5) make provision for equal and ratable pledges of the Notes Collateral to secure Additional Notes, (6) implement any Permitted Collateral Liens, (7) amend the Intercreditor Agreement or any Additional Intercreditor Agreement in accordance with the terms thereof; (8) make any change reasonably necessary, in the good faith determination of the Issuer in order to implement any transaction that is subject to the covenants described under the caption “—*Merger and Consolidation*”; or (9) implement any transaction in connection with the renewal extension, refinancing, replacement or increase of Indebtedness that is not prohibited by the Indenture or make any other change to any such agreement that does not adversely affect the Holders in any material respect; *provided* that no such changes shall be permitted to the extent they affect the ranking of any Note or Note Guarantee, enforcement of Liens over the Notes Collateral, the application of proceeds from the enforcement of Notes Collateral or the release of any Note Guarantees or Lien over the Notes Collateral in a manner than would adversely affect the rights of the holders of the Notes in any material respect except as otherwise permitted by the Indenture, the Intercreditor Agreement or any Additional Intercreditor Agreement immediately prior to such change. The Issuer shall not otherwise direct the Trustee or the Security Agent to enter into any amendment to any Intercreditor Agreement without the consent of the Holders of the majority in aggregate principal amount of the Notes then outstanding, except as otherwise permitted below under “Amendments and Waivers”, and the Issuer may only direct the Trustee and the Security Agent to enter into any amendment to the extent such amendment does not impose any personal obligations on the Trustee or Security Agent or, in the opinion of the Trustee or Security Agent, adversely affect their respective rights, duties, liabilities or immunities under the Indenture or the Intercreditor Agreement or any Additional Intercreditor Agreement.

The Indenture also provides that, in relation to any Intercreditor Agreement or Additional Intercreditor Agreement, at the request of the Issuer, the Trustee (and Security Agent, if applicable) shall consent on behalf of the Holders to the payment, repayment, purchase, repurchase, defeasance, acquisition, retirement or redemption of any obligations subordinated to the Notes thereby; *provided, however*, that such transaction would comply with the covenant described under “—*Limitation on Restricted Payments*”.

The Indenture also provides that each Holder, by accepting a Note, shall be deemed to have agreed to and accepted the terms and conditions of the Intercreditor Agreement or any Additional Intercreditor Agreement (whether then entered into or entered into in the future pursuant to the provisions described herein), and to have directed the Trustee and the Security Agent to enter into any such Additional Intercreditor Agreement.

Completion Date and Post-Completion Date Guarantees and Security

Subject to the Agreed Security Principles:

On the Completion Date:

- (1) Altice International will cause each Completion Date Guarantor to execute a supplemental indenture Guaranteeing the Notes on a senior basis; and
- (2) each of the Issuer and Altice International will, and Altice International will cause each of the relevant Restricted Subsidiaries to grant Liens on a senior basis over the property and assets described in clause (i) above under “*Notes Security*” by executing and delivering to the Security Agent the Security Documents to which it is intended to be a party or by virtue of the Intercreditor agreement.

Within 10 Business Days after the Completion Date, Altice International will cause all of the Capital Stock of the Target owned directly or indirectly by Altice International to be pledged to secure the Notes on a first-priority basis.

Within 90 days after the Completion Date, Altice International will cause:

- (1) each Post-Completion Date Guarantor to execute (i) a supplemental indenture Guaranteeing the Notes on a senior basis, (ii) a supplemental indenture to each Existing Senior Secured Notes Indenture Guaranteeing the Existing Senior Secured Notes on a senior basis, and (iii) an accession agreement to the Existing Senior Credit Facility Guaranteeing the Existing Term Loans on a senior basis; and
- (2) each of the Target and the relevant Restricted Subsidiaries of the Target to grant first-ranking Liens over the property and assets described in clause (iii) above under “*Notes Security*” by executing and delivering to the Security Agent the Security Documents to which it is intended to be a party.

Completion of the Transactions

The Issuer and Altice International shall cause the Acquisition to be consummated promptly upon the release of the Escrowed Property following delivery by the Issuer to the Escrow Agent of a release officer's certificate under the Notes Escrow Agreement.

Events of Default

Each of the following is an "Event of Default" under the Indenture:

- (1) default in any payment of interest or Additional Amounts, if any, on any Note issued under the Indenture when due and payable, continued for 30 days;
- (2) default in the payment of the principal amount of or premium, if any, on any Note issued under the Indenture when due at its Stated Maturity, upon optional redemption, upon required repurchase, upon declaration or otherwise;
- (3) failure by Altice International or any Restricted Subsidiary to comply for 30 days after notice by the Trustee or the Holders of at least 25% in principal amount of the outstanding Notes with any of its obligations under the covenants described under "Change of Control" above or under the covenants described under "*Certain Covenants*" above (in each case, other than (i) a failure to purchase Notes, which will constitute an Event of Default under clause (2) above; (ii) a failure to comply with the covenant described under "*Certain Covenants—Completion Date and Post-Completion Date Guarantees and Security*", which shall be governed by clause (10) below; (iii) a failure to comply with the Notes Escrow Agreement and (iv) a failure to comply with the covenant described under "*Certain Covenants—Completion of the Transactions*", which shall be governed by clause (12) below);
- (4) failure by Altice International, any Restricted Subsidiary or any other grantor of a Lien over the Notes Collateral to comply for 60 days after notice by the Trustee or the Holders of at least 25% in principal amount of the outstanding Notes with its other agreements contained in the Indenture, the Intercreditor Agreement, any Additional Intercreditor Agreement or the Security Documents;
- (5) default under any mortgage, indenture or instrument under which there may be issued or by which there may be secured or evidenced any Indebtedness for money borrowed by Altice International or any Restricted Subsidiary (or the payment of which is Guaranteed by Altice International or any Restricted Subsidiary) other than Indebtedness owed to Altice International or a Restricted Subsidiary whether such Indebtedness or Guarantee now exists, or is created after the Issue Date, which default:
 - (a) is caused by the failure to pay principal of such Indebtedness at the Stated Maturity thereof prior to the expiration of the grace period provided in such Indebtedness on the date of such default ("payment default"); or
 - (b) results in the acceleration of such Indebtedness prior to its maturity (the "cross-acceleration provision"),and, in each case, the principal amount of any such Indebtedness, together with the principal amount of any other such Indebtedness under which there has been a payment default or the maturity of which has been so accelerated, aggregates €25 million or more;
- (6) certain events of bankruptcy, insolvency or court protection of the Issuer, Altice International or a Significant Subsidiary or group of Restricted Subsidiaries that, taken together, would constitute a Significant Subsidiary (the "bankruptcy provisions");
- (7) failure by the Issuer, Altice International or a Significant Subsidiary or group of Restricted Subsidiaries that, taken together, would constitute a Significant Subsidiary to pay final judgments aggregating in excess of €25 million, exclusive of any amounts that a solvent insurance company has acknowledged liability for, which judgments are not paid, discharged or stayed for a period of 60 days after the judgment becomes final (the "judgment default provision");
- (8) any security interest under the Security Documents shall, at any time, cease to be in full force and effect (other than in accordance with the terms of the relevant Security Document, the Intercreditor Agreement, any Additional Intercreditor Agreement and the Indenture) with respect to Notes Collateral having a fair market

value in excess of €10 million for any reason other than the satisfaction in full of all obligations under the Indenture or the release of any such security interest in accordance with the terms of the Indenture, the Intercreditor Agreement, any Additional Intercreditor Agreement or the Security Documents or any such security interest created thereunder shall be declared invalid or unenforceable and the Issuer shall assert in writing that any such security interest is invalid or unenforceable and any such Default continues for 10 days (the “security default provisions”);

- (9) any Note Guarantee by Altice International or a Subsidiary Guarantor that is a Significant Subsidiary or any group of Subsidiary Guarantors that taken together would constitute a Significant Subsidiary ceases to be in full force and effect (other than in accordance with the terms of such Note Guarantee or the Indenture) or is declared invalid or unenforceable in a judicial proceeding or any Guarantor denies or disaffirms in writing its obligations under its Note Guarantee and any such Default continues for 10 days after the notice specified in the Indenture (the “guarantee provisions”);
- (10) failure by Altice International or any Restricted Subsidiary to comply for 30 days with any of the provisions of the covenant described under—*Certain Covenants—Completion Date and Post-Completion Date Guarantees and Security*;
- (11) failure by the Issuer to consummate a Special Mandatory Redemption as described under the caption “—*Escrow of Proceeds; Special Mandatory Redemption*”; and
- (12) failure by the Issuer to comply with the covenant described under “—*Certain Covenants—Completion of the Transactions*” for more than 5 Business Days following the date on which the Escrowed Property are released from the Notes Escrow Accounts.

However, a default under clauses (3), (4), (5), (7) or (10) of this paragraph will not constitute an Event of Default until the Trustee or the Holders of 25% in principal amount of the outstanding Notes under the Indenture notify the Issuer of the default and, with respect to clauses (3), (4), (5), (7) and (10) the Issuer does not cure such default within the time specified in clauses (3), (4), (5), (7) or (10), as applicable, of this paragraph after receipt of such notice.

If an Event of Default described in clause (6) or (11) above occurs and is continuing, the principal of, premium, if any, and accrued and unpaid interest on all the Notes, and any additional amounts, if any, will become and be immediately due and payable without any declaration or other act on the part of the Trustee or any Holders. If any other Event of Default occurs and is continuing, the Trustee or the Holders of at least 25% in aggregate principal amount of the then outstanding Notes may and, if directed by holders of at least 25% in aggregate principal amount of the then outstanding Notes, the Trustee shall, declare all the Notes to be due and payable immediately. In the event of a declaration of acceleration of the Notes because an Event of Default described in clause (5) under “Events of Default” has occurred and is continuing, the declaration of acceleration of the Notes shall be automatically annulled if the event of default or payment default triggering such Event of Default pursuant to clause (5) shall be remedied or cured, or waived by the holders of the relevant Indebtedness, or the relevant Indebtedness that gave rise to such Event of Default shall have been discharged in full, within 30 days after the declaration of acceleration with respect thereto and if (i) the annulment of the acceleration of the Notes would not conflict with any judgment or decree of a court of competent jurisdiction and (ii) all existing Events of Default, except nonpayment of principal, premium or interest, including Additional Amounts, if any, on the Notes that became due solely because of the acceleration of the Notes, have been cured or waived.

Holders of the Notes may not enforce the Indenture or the Notes except as provided in the Indenture and may not enforce the Security Documents except as provided in such Security Documents and the Intercreditor Agreement or any Additional Intercreditor Agreement.

The Holders of a majority in principal amount of the outstanding Notes under the Indenture may waive all past or existing Defaults or Events of Default (except with respect to nonpayment of principal, premium, interest or Additional Amounts, if any) and rescind any such acceleration with respect to such Notes and its consequences if rescission would not conflict with any judgment or decree of a court of competent jurisdiction.

Subject to the provisions of the Indenture relating to the duties of the Trustee, if an Event of Default occurs and is continuing, the Trustee will be under no obligation to exercise any of the rights or powers under the Indenture at the request or direction of any of the Holders unless such Holders have offered to the Trustee, and the Trustee has received, indemnity and/or security satisfactory to the Trustee against any loss, liability or expense. Except to enforce the right to receive payment of principal or interest when due, no Holder may pursue any remedy with respect to the Indenture or the Notes unless:

- (1) such Holder has previously given the Trustee notice that an Event of Default is continuing;

- (2) Holders of at least 25% in aggregate principal amount of the outstanding Notes have requested the Trustee to pursue the remedy;
- (3) such Holders have offered the Trustee, and the Trustee has received, security and/or indemnity satisfactory to it against any loss, liability or expense;
- (4) the Trustee has not complied with such request within 60 days after the receipt of the request and the offer of security and/or indemnity; and
- (5) the Holders of a majority in aggregate principal amount of the outstanding Notes have not given the Trustee a direction that, in the opinion of the Trustee, is inconsistent with such request within such 60-day period.

Subject to certain restrictions, the Holders of a majority in principal amount of the outstanding Notes are given the right to direct the time, method and place of conducting any proceeding for any remedy available to the Trustee (on behalf of the Holders) or of exercising any trust or power conferred on the Trustee (on behalf of the Holders).

The Indenture provides that, in the event an Event of Default has occurred and is continuing of which a responsible officer of the Trustee is aware, the Trustee will be required in the exercise of its powers to use the degree of care that a prudent person would use in the conduct of its own affairs. The Trustee, however, may refuse to follow any direction that conflicts with law or the Indenture or that the Trustee determines is unduly prejudicial to the rights of any other Holder or that would involve the Trustee in personal liability. Prior to taking any action under the Indenture, the Trustee will be entitled to indemnification and/or security satisfactory to it in its sole discretion against all losses and expenses caused by taking or not taking such action. The Indenture provides that if a Default occurs and is continuing and a responsible officer of the Trustee is informed of such occurrence by the Issuer, the Trustee must give notice of the Default to the Holders within 60 days after being notified by the Issuer. Except in the case of a Default in the payment of principal of, or premium, if any, or interest on any Note, the Trustee may withhold notice if and so long as a committee of trust officers of the Trustee in good faith determines that withholding notice is in the interests of the Holders. The Issuer is required to deliver to the Trustee, within 120 days after the end of each fiscal year, an Officer's Certificate indicating whether the signers thereof know of any Default that occurred during the previous year. The Issuer is required to deliver to the Trustee, within 30 days after the occurrence thereof, written notice of any events of which it is aware which would constitute certain Defaults, their status and what action the Issuer is taking or proposes to take in respect thereof.

The Notes provide for the Trustee to take action on behalf of the Holders in certain circumstances, but only if the Trustee is indemnified and/or secured to its satisfaction. It may not be possible for the Trustee to take certain actions in relation to the Notes and, accordingly, in such circumstances the Trustee will be unable to take action, notwithstanding the provision of an indemnity to it, and it will be for Holders to take action directly.

Amendments and Waivers

Subject to certain exceptions, the Notes Documents may be amended, supplemented or otherwise modified with the consent of the Holders of a majority in principal amount of the Notes then outstanding (including consents obtained in connection with a purchase of, or tender offer or exchange offer for, Notes) and, subject to certain exceptions, any default or compliance with any provisions thereof may be waived with the consent of the Holders of a majority in principal amount of the Notes then outstanding (including consents obtained in connection with a purchase of, or tender offer or exchange offer for, Notes); provided, however that if any amendment, waiver or other modification will only affect the Dollar Notes or Euro Notes only the consent of the holders of at least a majority in principal amount of the then outstanding Dollar Notes or Euro Notes (and not the consent of at least a majority of all Notes then outstanding), as the case may be, shall be required. However, without the consent of Holders holding not less than 90% of the then outstanding principal amount of Notes affected (including consents obtained in connection with a purchase of, or tender offer or exchange offer for, Notes); *provided, however* that if any amendment, waiver or other modification will only affect the Dollar Notes or Euro Notes only the consent of the holders of at least 90% of the aggregate principal amount of the then outstanding Dollar Notes or Euro Notes, as the case may be (and not the consent of at least 90% of the aggregate principal amount of all Notes then outstanding), an amendment or waiver may not, with respect to any Notes held by a non-consenting Holder:

- (1) reduce the principal amount of Notes whose Holders must consent to an amendment, waiver, supplement or modification;
- (2) reduce the stated rate of or extend the stated time for payment of interest on any Note (other than, for the avoidance of doubt, any payment pursuant to a Change of Control Offer or pursuant to the provisions of the covenant described under the caption "*—Limitation on Sales of Assets and Subsidiary Stock*");
- (3) reduce the principal of, or extend the Stated Maturity of, any Note;

- (4) reduce the premium payable upon the redemption of any Note or change the time at which any Note may be redeemed, in each case as described above under “—*Optional Redemption*” (other than, for the avoidance of doubt, any payment pursuant to a Change of Control Offer or pursuant to the provisions of the covenant described under the caption “—*Limitation on Sales of Assets and Subsidiary Stock*”);
- (5) make any Note payable in money other than that stated in the Note (except to the extent the currency stated in the Notes has been succeeded or replaced pursuant to applicable law);
- (6) impair the right of any Holder to receive payment of principal of and interest or Additional Amounts, if any, on such Holder’s Notes on or after the due dates therefor or to institute suit for the enforcement of any such payment on or with respect to such Holder’s Notes (it being understood that this clause (6) will not apply to provisions under the caption “*Change of Control*” and “*Limitation on Sales of Assets and Subsidiary Stock*” except to the extent payments thereunder are at such time due and payable);
- (7) make any change in the provision of the Indenture described under “*Withholding Taxes*” that adversely affects the right of any Holder of such Notes in any material respect or amends the terms of such Notes in a way that would result in a loss of an exemption from any of the Taxes described thereunder or an exemption from any obligation to withhold or deduct Taxes so described thereunder unless the payor agrees to pay Additional Amounts, if any, in respect thereof;
- (8) waive a Default or Event of Default with respect to the nonpayment of principal, premium or interest or Additional Amounts, if any, on the Notes (except pursuant to a rescission of acceleration of the Notes by the Holders of at least a majority in aggregate principal amount of such Notes and a waiver of the payment default that resulted from such acceleration); or
- (9) make any change in the amendment or waiver provisions which require the Holders’ consent described in this sentence.

In addition, (A) without the consent of at least 75% in aggregate principal amount of Notes then outstanding (*provided, however, that if any amendment, waiver or other modification will only affect the Dollar Notes or Euro Notes only the consent of the holders of at least 75% of the aggregate principal amount of the then outstanding Dollar Notes or Euro Notes, as the case may be (and not the consent of at least 75% of the aggregate principal amount of all Notes of such series then outstanding) will be required*), no amendment or supplement may: (1) release any Guarantor, HOT Proceeds Note Guarantor, or OMT Proceeds Loan Guarantor, respectively, from any of its obligations under its Note Guarantee, HOT Proceeds Note Guarantee, OMT Proceeds Loan Guarantees, the Indenture, HOT Proceeds Note, or OMT Proceeds Loan, as applicable, except in accordance with the terms of the Indenture, and the Intercreditor Agreement; or (2) release any of the security interests granted for the benefit of the Holders in the Notes Collateral, the HOT Proceeds Note Collateral, the OMT Proceeds Loans Collateral, as applicable (to the extent any Notes Collateral, HOT Proceeds Notes Collateral or OMT Proceeds Notes Collateral, as applicable, so released in any transactions or series of transactions has a fair market value in excess of €25 million) other than in accordance with the terms of, as applicable, the Security Documents, the HOT Security Documents, the OMT Security Documents, the Intercreditor Agreement, any applicable Additional Intercreditor Agreement, and the Indenture, as applicable. Notwithstanding the foregoing, without the consent of any Holder, the Issuer, the Trustee, the Security Agent and the other parties thereto, as applicable, may amend or supplement any Notes Documents to:

- (1) cure any ambiguity, omission, defect, error or inconsistency;
- (2) provide for the assumption by a successor Person of the obligations of the Issuer or any Guarantor under any Notes Document;
- (3) provide for the assumption of a successor Person of the obligations of (i) any HOT Proceeds Note Obligor under any HOT Proceeds Note Document; or (ii) NewCo OMT and its Subsidiaries under any OMT Proceeds Loans Document;
- (4) add to the covenants or provide for a Guarantee for the benefit of the Holders or surrender any right or power conferred upon Altice International or any Restricted Subsidiary;
- (5) add to the covenants or provide for a HOT Proceeds Note Guarantee for the benefit of the Issuer or surrender any right or power conferred upon HOT, a HOT Proceeds Note Guarantor, any Subsidiary of HOT that is a Restricted Subsidiary or NewCo OMT or any Subsidiary of NewCo OMT that is a Restricted Subsidiary;

- (6) make any change that would provide additional rights or benefits to the Trustee or the Holders or does not adversely affect the rights or benefits to the Trustee or any of the Holders in any material respect under the Notes Documents;
- (7) make any change that would provide additional rights or benefits to the Issuer or does not adversely affect the rights or benefits to the Issuer in any material respect, in each case, under the HOT Proceeds Note Documents, the OMT Proceeds Loan Documents or any other Issuer Proceeds Loan;
- (8) make such provisions as necessary (as determined in good faith by the Issuer) for the issuance of Additional Notes Incurred in accordance with the terms of the Indenture;
- (9) provide for Altice International or a Restricted Subsidiary to provide a Note Guarantee in accordance with the Indenture, to add Guarantees with respect to the Notes, to add security to or for the benefit of the Notes, or to effectuate or confirm and evidence the release, termination, discharge or retaking of any Note Guarantee or Lien (including the Notes Collateral and the Security Documents) or any amendment in respect thereof with respect to or securing the Notes when such release, termination, discharge or retaking or amendment is provided for under the Indenture, the Security Documents, the Intercreditor Agreement or any Additional Intercreditor Agreement;
- (10) provide for to add Guarantees with respect to the HOT Proceeds Note or an OMT Proceeds Loan, to add security to or for the benefit of the HOT Proceeds Note or an OMT Proceeds Loan, or to effectuate or confirm and evidence the release, termination, discharge or retaking of any HOT Proceeds Note Guarantee or Lien or any OMT Proceeds Loan Guarantee or Lien (including the HOT Proceeds Note Collateral and the HOT Security Documents and OMT Proceeds Loans Collateral and the OMT Security Documents) or any amendment in respect thereof with respect to or securing the HOT Proceeds Note or an OMT Proceeds Loan when such release, termination, discharge or retaking or amendment is provided for under the Indenture, the HOT Security Documents or the OMT Security Documents, as applicable or any intercreditor agreement relating to the HOT Proceeds Note or the OMT Proceeds Loans;
- (11) conform the text of the Indenture, the Note Guarantees, the Security Documents, the Notes, the HOT Proceeds Note Guarantees, the HOT Proceeds Note Documents, the HOT Proceeds Note, the OMT Proceeds Loans Security Documents or any OMT Proceeds Loan to any provision of this “Description of Senior Secured Notes” to the extent that such provision in this “Description of Senior Secured Notes” was intended to be a verbatim recitation of a provision of the Indenture, a Note Guarantee, the Security Documents, the Notes, the HOT Proceeds Note Guarantees, the HOT Proceeds Note Documents, the HOT Proceeds Note, the OMT Proceeds Loans Security Documents or any OMT Proceeds Loan;
- (12) evidence and provide for the acceptance and appointment under the Indenture or the Intercreditor Agreement or any Additional Intercreditor Agreement of a successor Trustee or Security Agent pursuant to the requirements thereof or to provide for the accession by the Trustee or Security Agent to any Notes Document;
- (13) as provided in “—*Certain Covenants—Additional Intercreditor Agreements*”;
- (14) after a HOT Direct Obligation Event, amend, extend, renew, restate, supplement or otherwise modify or release the HOT Proceeds Note and the HOT Security Documents, as the case may be, to give effect to a repayment or reduction in the aggregate principal amount of the HOT Proceeds Note; or
- (15) after an OMT Direct Obligation Event, amend, extend, renew, restate, supplement or otherwise modify or release the OMT Security Documents or any OMT Proceeds Loan, as the case may be, to give effect to a repayment or reduction in the aggregate principal amount of the OMT Proceeds Loans.

In formulating its decision on such matters, the Trustee shall be entitled to require and rely absolutely on such evidence as it deems necessary, including Officer’s Certificates and Opinions of Counsel.

The consent of the Holders is not necessary under the Indenture to approve the particular form of any proposed amendment. It is sufficient if such consent approves the substance of the proposed amendment. A consent to any amendment or waiver under the Indenture by any Holder of Notes given in connection with a tender of such Holder’s Notes will not be rendered invalid by such tender.

For the purpose of calculating the aggregate principal amount of Notes that have consented to or voted in favor of any amendment, supplement or waiver, the Euro Equivalent of the principal amount of any Dollar Notes shall be as of the Issue Date.

For the avoidance of doubt, the provisions of articles 86 to 94-8 of the Luxembourg act dated 10 August 1915 on commercial companies, as amended, shall not apply in respect of the Notes.

For so long as the Notes are listed on the Euro MTF Market of the Luxembourg Stock Exchange and the rules of such exchange so require, the Issuer will publish notice of any amendment, supplement and waiver in Luxembourg in a daily newspaper with general circulation in Luxembourg (which is expected to be the *Luxemburger Wort*). Such notice of any amendment, supplement and waiver may also be published on the website of the Luxembourg Stock Exchange (www.bourse.lu), to the extent and in the manner permitted by the rules of the Luxembourg Stock Exchange.

Acts by Holders

In determining whether the Holders of the required principal amount of the Notes have concurred in any direction, waiver or consent, the Notes owned by Altice International or by any Person directly or indirectly controlling, or controlled by, or under direct or indirect common control with Altice International will be disregarded and deemed not to be outstanding.

Defeasance

The Issuer at any time may terminate all obligations of the Issuer under the Notes and the Indenture (“legal defeasance”) and cure all then existing Defaults and Events of Default, except for certain obligations, including those respecting the right to receive payment, defeasance trust, the rights, powers, trusts, duties, immunities and indemnities of the Trustee and the obligations of the Issuer in connection therewith and obligations concerning issuing temporary Notes, registration of Notes, mutilated, destroyed, lost or stolen Notes and the maintenance of an office or agency for payment and money for security payments held in trust. Subject to the foregoing, if the Issuer exercises its legal defeasance option, the Security Documents and the rights of the Trustee and the Holders under the Intercreditor Agreement or any Additional Intercreditor Agreement in effect at such time will terminate (other than with respect to the defeasance trust).

The Issuer at any time may terminate its obligations under certain covenants described under “—*Certain Covenants*” and “*Change of Control*” and the default provisions relating to such covenants described under “*Events of Default*” above, the operation of the cross-default upon a payment default, the cross-acceleration provisions, the bankruptcy provisions with respect to the Issuer, Altice International and Significant Subsidiaries, the judgment default provision, the guarantee provision and the security default provision described under “*Events of Default*” above (“covenant defeasance”).

The Issuer at its option at any time may exercise its legal defeasance option notwithstanding its prior exercise of its covenant defeasance option. If the Issuer exercises its legal defeasance option, payment of the Notes may not be accelerated because of an Event of Default with respect to such Notes. If the Issuer exercises its covenant defeasance option with respect to the Notes, payment of the Notes may not be accelerated because of an Event of Default specified in clause (3) (other than with respect to the first paragraph and clauses (1) and (2) of the second paragraph of the covenant described under “—*Certain Covenants—Merger and Consolidation*”), (4), (5), (6) (with respect only to Altice International and Significant Subsidiaries), (7), (8) or (9) under “*Events of Default*” above.

In order to exercise either defeasance option, the Issuer must irrevocably deposit in trust (the “defeasance trust”) with the Trustee (or an entity designated or appointed as agent by it for this purpose) cash in U.S. dollars or U.S. dollar-denominated U.S. Government Obligations or a combination thereof (in the case of the Dollar Notes) and cash in euro or euro-denominated European Government Obligations or a combination thereof (in the case of the Euro Notes) for the payment of principal, premium, if any, and interest on the Notes to redemption or maturity, as the case may be, and must comply with certain other conditions, including delivery to the Trustee of:

- (1) an Opinion of Counsel (subject to customary exceptions and exclusions) from United States counsel to the effect that Holders of the Notes will not recognize income, gain or loss for U.S. federal income tax purposes as a result of such deposit and defeasance and will be subject to U.S. federal income tax on the same amount and in the same manner and at the same times as would have been the case if such deposit and defeasance had not occurred (and in the case of legal defeasance only, such Opinion of Counsel from United States counsel must be based on a ruling of the U.S. Internal Revenue Service or other change in applicable U.S. federal income tax law);
- (2) an Officer’s Certificate stating that the deposit was not made by the Issuer with the intent of defeating, hindering, delaying, defrauding or preferring any creditors of the Issuer;
- (3) an Officer’s Certificate stating that all conditions precedent provided for or relating to legal defeasance or covenant defeasance, as the case may be, have been complied with; and
- (4) an Opinion of Counsel to the effect that the trust resulting from the deposit does not constitute, or is qualified as, a regulated investment company under the U.S. Investment Company Act of 1940, as amended.

Satisfaction and Discharge

The Indenture, and the rights of the Trustee and the Holders under the Intercreditor Agreement, any Additional Intercreditor Agreement and the Security Documents will be discharged and cease to be of further effect (except as to surviving rights of conversion or transfer or exchange of the Notes, as expressly provided for in the Indenture) as to all outstanding Notes when (1) either (a) all the Notes previously authenticated and delivered (other than certain lost, stolen or destroyed Notes, and certain Notes for which provision for payment was previously made and thereafter the funds have been released to the Issuer) have been delivered to the relevant Paying Agent for cancellation; or (b) all Notes not previously delivered to the relevant Paying Agent for cancellation (i) have become due and payable, (ii) will become due and payable at their Stated Maturity within one year or (iii) are to be called for redemption within one year under arrangements reasonably satisfactory to the Trustee for the giving of notice of redemption by the Trustee in the name, and at the expense, of the Issuer; (2) the Issuer has deposited or caused to be deposited with the Trustee (or an entity designated or appointed as agent by it for this purpose), cash in U.S. dollars or U.S. dollar-denominated U.S. Government Obligations or a combination thereof (in the case of the Dollar Notes) and cash in euro or euro-denominated European Government Obligations or a combination thereof (in the case of the Euro Notes), in an amount sufficient to pay and discharge the entire Indebtedness on the Notes not previously delivered to the Trustee for cancellation, for principal, premium, if any, and interest to the date of deposit (in the case of Notes that have become due and payable), or to the Stated Maturity or redemption date, as the case may be; (3) the Issuer has paid or caused to be paid all other sums payable under the Indenture; and (4) the Issuer has delivered to the Trustee an Officer's Certificate to the effect that all conditions precedent under the "Satisfaction and Discharge" section of the Indenture relating to the satisfaction and discharge of the Indenture have been complied with.

No Personal Liability of Directors, Officers, Employees and Shareholders

No director, officer, employee, incorporator or shareholder of the Issuer, Altice International or any of their respective Subsidiaries or Affiliates, as such, shall have any liability for any obligations of the Issuer under the Notes Documents or for any claim based on, in respect of, or by reason of, such obligations or their creation. Each Holder by accepting a Note waives and releases all such liability. The waiver and release are part of the consideration for issuance of the Notes. Such waiver may not be effective to waive liabilities under the U.S. federal securities laws, and it is the view of the SEC that such a waiver is against public policy.

Listing and General Information

Application has been made to list the Notes on the Official List of the Luxembourg Stock Exchange and to admit the Notes to trading on the Euro MTF Market. There can be no assurance that the application to list the Notes on the Euro MTF Market of the Luxembourg Stock Exchange and to admit the Notes to trading on the Euro MTF Market will be approved, and settlement of the Notes is not conditioned on obtaining this listing.

So long as the Notes are listed on the Official List of the Luxembourg Stock Exchange and admitted to trading on its Euro MTF Market and the rules and regulations of the Luxembourg Stock Exchange shall so require, copies, current and future, of all of Altice International's annual audited consolidated financial statements, Altice International's unaudited consolidated interim quarterly financial statements and this Offering Memorandum may be obtained, free of charge, during normal business hours at the registered office of the Issuer.

Available Information

Anyone who receives this Offering Memorandum, any Holder of the Notes or holder of a beneficial interest in the Notes, following the Issue Date, may obtain a copy of the Indenture, the form of Notes, the Security Documents, the Notes Escrow Agreement and the Intercreditor Agreement without charge by writing to the Issuer, 3 Boulevard Royal L-2449 Luxembourg, Attention: Chief Financial Officer.

Concerning the Trustee and Certain Agents

Deutsche Bank AG, London Branch has been appointed as Trustee under the Indenture. The Indenture provides that, except during the continuance of an Event of Default, the Trustee will perform only such duties as are set forth specifically in the Indenture. The holders of a majority in aggregate principal amount of the then outstanding Notes will have the right to direct the time, method and place of conducting any proceeding for exercising any remedy available to the Trustee, subject to certain exceptions. During the existence of an Event of Default of which the Trustee has been notified in accordance with the provisions of the Indenture, the Trustee will exercise such of the rights and powers vested in it under the Indenture and use the same degree of care that a prudent Person would use in conducting its own affairs. The permissive rights of the Trustee to take or refrain from taking any action enumerated in the Indenture will not be construed as an obligation or duty.

The Issuer shall deliver written notice to the Trustee with thirty (30) days of becoming aware of the occurrence of a Default or Event of Default. The Indenture imposes certain limitations on the rights of the Trustee, should it become a creditor of the Issuer, to obtain payment of claims in certain cases, or to realize on certain property received in respect of any such claim as security or otherwise. The Trustee, the Paying Agents and the Registrars will be permitted to engage in other transactions with the Issuer and its Affiliates and Subsidiaries.

Any removal or resignation of the Trustee shall not become effective until the acceptance of appointment by the successor Trustee.

The Indenture contains provisions for the indemnification and/or security of the Trustee by the Issuer and the Guarantors for any loss, liability, taxes or expenses incurred without gross negligence, willful misconduct or bad faith on its part, arising out of or in connection with the acceptance or administration of the Indenture.

Notices

All notices to Holders of the Notes will be validly given if mailed to them at their respective addresses in the register of the Holders of such Notes, if any, maintained by the Registrar. In addition, for so long as any of the Notes are listed on the Euro MTF Market of the Luxembourg Stock Exchange and the rules of the Luxembourg Stock Exchange so require, notices with respect to the Notes will be published in a newspaper having a general circulation in Luxembourg (which is expected to be the Luxemburger Wort) or, to the extent and in the manner permitted by such rules, posted on the official website of the Luxembourg Stock Exchange (www.bourse.lu).

Each such notice shall be deemed to have been given on the date of such publication or, if published more than once on different dates, on the first date on which publication is made; *provided* that, if notices are mailed, such notice shall be deemed to have been given on the later of such publication and the seventh day after being so mailed. Any notice or communication mailed to a Holder shall be mailed to such Person by first-class mail or other equivalent means and shall be sufficiently given to such Holder if so mailed within the time prescribed. Failure to mail a notice or communication to a Holder or any defect in it shall not affect its sufficiency with respect to other Holders. If a notice or communication is mailed in the manner provided above, it is duly given, whether or not the addressee receives it.

For Notes which are represented by global certificates held on behalf of DTC, Euroclear or Clearstream, notices may be given by delivery of the relevant notices to DTC, Euroclear or Clearstream for communication to entitled account holders in substitution for the aforesaid mailing.

Prescription

Claims against the Issuer or any Guarantor for the payment of principal, or premium, if any, on the Notes will be prescribed ten years after the applicable due date for payment thereof. Claims against the Issuer or any Guarantor for the payment of interest on the Notes will be prescribed five years after the applicable due date for payment of interest.

Currency Indemnity

The sole currency of account and payment for all sums payable by the Issuer and the Guarantors under or in connection with the Dollar Notes and Note Guarantees thereof is U.S. dollars and the Euro Notes and Note Guarantees thereof is euro, including damages. Any amount received or recovered in a currency other than U.S. dollars or euro, whether as a result of, or the enforcement of, a judgment or order of a court of any jurisdiction, in the winding-up or dissolution of the Issuer, any Guarantor or otherwise by any Holder or by the Trustee, in respect of any sum expressed to be due to it from the Issuer or a Guarantor will only constitute a discharge to the Issuer or such Guarantor, as applicable, to the extent of the U.S. dollar or euro amount, as the case may be, which the recipient is able to purchase with the amount so received or recovered in that other currency on the date of that receipt or recovery (or, if it is not practicable to make that purchase on that date, on the first date on which it is practicable to do so).

If that U.S. dollar or euro amount is less than the U.S. dollar or euro amount expressed to be due to the recipient or the Trustee under any Note, the Issuer and the Guarantors will indemnify them against any loss sustained by such recipient or the Trustee as a result. In any event, the Issuer and the Guarantors will indemnify the recipient or the Trustee on a joint or several basis against the cost of making any such purchase. For the purposes of this currency indemnity provision, it will be *prima facie* evidence of the matter stated therein for the Holder of a Note or the Trustee to certify in a manner reasonably satisfactory to the Issuer (indicating the sources of information used) the loss it Incurred in making any such purchase. These indemnities constitute a separate and independent obligation from the Issuer's and the Guarantors' other obligations, will give rise to a separate and independent cause of action, will apply irrespective of any waiver granted by any Holder of a Note or the Trustee (other than a waiver of the indemnities set out herein) and will continue in full force and effect despite any other judgment, order, claim or proof for a liquidated amount in respect of any sum due under any Note, any Note Guarantee or to the Trustee.

Enforceability of Judgments

Since substantially all the assets of the Issuer, Altice International and the other Guarantors are located outside the United States, any judgment obtained in the United States against the Issuer or any Guarantor, including judgments with respect to the payment of principal, premium, interest, Additional Amounts, if any, and any redemption price and any purchase price with respect to the Notes or the Note Guarantees, may not be collectable within the United States.

Consent to Jurisdiction and Service

In relation to any legal action or proceedings arising out of or in connection with the Indenture, the Notes and the Note Guarantees, the Issuer and each Guarantor will, in the Indenture, appoint CT Corporation System as its agent for service of process and irrevocably submit to the jurisdiction of the federal and state courts in the Borough of Manhattan in the City of New York, County and State of New York, United States.

Governing Law

The Indenture, the Notes and the Note Guarantees, and the rights and duties of the parties thereunder shall be governed by and construed in accordance with the laws of the State of New York. The application of the provisions set out in Articles 86 to 94-8 of the Luxembourg law dated August 10, 1915 on commercial companies, as amended, is excluded. The Intercreditor Agreement is, and the rights and duties of the parties thereunder are, governed by and construed in accordance with the laws of England. The Security Documents and the HOT Security Documents are and/or shall be governed by and construed in accordance with the laws of the State of Israel, Portugal, the Dominican Republic, England, France, Switzerland, the Bahamas, and the Grand Duchy of Luxembourg, as applicable. The HOT Proceeds Note is governed by and construed in accordance with the laws of England. The OMT Proceeds Loans are governed by and construed in accordance with the laws of France.

Certain Definitions

Set forth below are certain defined terms used in the Indenture. Reference is made to the Indenture for a full disclosure of all defined terms used therein, as well as any other capitalized terms used herein for which no definition is provided.

“*2013 Revolving Credit Facility*” means the revolving credit facility agreement, dated July 1, 2013, as amended, restated, supplemented or otherwise modified from time to time, among the Issuer, as borrower, the lenders from time to time party thereto, Citibank International Plc as facility agent and Citibank, N.A., London Branch, as security agent.

“*ABO*” means Altice Blue One SAS, a société par actions simplifiée, incorporated under the laws of France.

“*Acquired Indebtedness*” means Indebtedness (1) of a Person or any of its Subsidiaries existing at the time such Person becomes a Restricted Subsidiary, (2) assumed in connection with the acquisition of assets from such Person, in each case whether or not Incurred by such Person in connection with such Person becoming a Restricted Subsidiary or such acquisition, or (3) of a Person at the time such Person merges with or into or consolidates or otherwise combines with Altice International or any Restricted Subsidiary. Acquired Indebtedness shall be deemed to have been Incurred, with respect to clause (1) of the preceding sentence, on the date such Person becomes a Restricted Subsidiary and, with respect to clause (2) of the preceding sentence, on the date of consummation of such acquisition of assets and, with respect to clause (3) of the preceding sentence, on the date of the relevant merger, consolidation or other combination.

“*Additional Assets*” means:

- (1) any property or assets (other than Indebtedness and Capital Stock) not classified as current assets under IFRS used or to be used by Altice International or a Restricted Subsidiary or otherwise useful in a Similar Business (it being understood that capital expenditures on property or assets already used in a Similar Business or to replace any property or assets that are the subject of an Asset Disposition shall be deemed an investment in Additional Assets);
- (2) the Capital Stock of a Person that is engaged in a Similar Business and becomes a Restricted Subsidiary as a result of the acquisition of such Capital Stock by Altice International or a Restricted Subsidiary; or
- (3) Capital Stock constituting a minority interest in any Person that at such time is a Restricted Subsidiary.

“*Additional Revolving Credit Facilities*” means the New Super Senior Revolving Credit Facility and the New Pari Passu Revolving Credit Facility.

“*Affiliate*” of any specified Person means any other Person, directly or indirectly, controlling or controlled by or under direct or indirect common control with such specified Person. For the purposes of this definition, “control” when used with respect to any Person means the power to direct the management and policies of such Person, directly or indirectly, whether through the ownership of voting securities, by contract or otherwise; and the terms “controlling” and “controlled” have meanings correlative to the foregoing.

“*Aggregate Portuguese Security and Guarantee Limit Amount*” refers to, as applicable, (1) €95 million, representing the maximum aggregate amount of obligations (i) guaranteed by Altice Portugal and Cabovisão and (ii) secured by the Cabovisão Security (including the pledge over the shares in the Target, to be granted by Altice Portugal within 10 Business Days following the Completion Date), which limitation applies to all indebtedness so guaranteed and/or secured on an aggregate basis; (2) €45.8 million, representing the maximum aggregate amount of obligations secured by the ONI Security and guaranteed by the ONI Group, which limitation applies to all indebtedness so secured and/or guaranteed on an aggregate basis; and (3) (i) up to €4,634.4 million for the Target and (ii) €968.4 million for PT OpCo, representing the maximum aggregate amount of obligations secured by the Target and PT OpCo, respectively, and guaranteed by the Target and PT OpCo, respectively, which limitation applies to all indebtedness so secured and/or guaranteed on an aggregate basis.

“*Agreed Security Principles*” means principles set forth in Schedule 16 to the Additional Revolving Credit Facilities, which shall be attached as a schedule to the Indenture.

“*AI Mandatory Convertible Notes*” means the mandatory convertible notes issued by Altice International for an aggregate nominal amount of up to €2,055 million and subscribed to by Altice S.A. in connection with the Transactions.

“*Altice Bahamas*” means Altice Bahamas S.à r.l., a private limited liability company (*société à responsabilité limitée*), incorporated under the laws of the Grand Duchy of Luxembourg.

“*Altice Holdings*” refers to Altice Holdings S.à r.l., a private limited liability company (*société à responsabilité limitée*), incorporated under the laws of the Grand Duchy of Luxembourg.

“*Altice Portugal*” means Altice Portugal, S.A. a public limited liability company (*sociedade anónima*) incorporated under the laws of Portugal.

“*Altice West Europe*” refers to Altice West Europe S.à r.l. a private limited liability company (*société à responsabilité limitée*) incorporated under the laws of the Grand Duchy of Luxembourg.

“*Applicable Premium*” means:

- (A) with respect to any Dollar Note the greater of:
- (i) 1% of the principal amount of such Dollar Note; and
 - (ii) the excess (to the extent positive) of:
 - (1) the present value at such redemption date of (i) the redemption price of such Dollar Note at February 15, 2018 (such redemption price (expressed in percentage of principal amount) being set forth in the table above under the first paragraph of the “—*Optional Redemption*” section described above (excluding accrued and unpaid interest)), plus (ii) all required interest payments due on such Dollar Note to and including February 15, 2018 (excluding accrued but unpaid interest), computed upon the redemption date using a discount rate equal to the Treasury Rate at such redemption date plus 50 basis points; over
 - (2) the outstanding principal amount of such Dollar Note,
- (B) with respect to any Euro Note the greater of:
- (i) 1% of the principal amount of such Euro Note; and
 - (ii) the excess (to the extent positive) of:
 - (1) the present value at such redemption date of (i) the redemption price of such Euro Note at February 15, 2018 (such redemption price (expressed in percentage of principal amount) being set forth in the table above under the first paragraph of the “—*Optional Redemption*” section

described above (excluding accrued and unpaid interest)), plus (ii) all required interest payments due on such Euro Note to and including February 15, 2018 (excluding accrued but unpaid interest), computed upon the redemption date using a discount rate equal to the Bund Rate at such redemption date plus 50 basis points; over

- (2) the outstanding principal amount of such Euro Note,

in each case, as calculated by the Issuer or on behalf of the Issuer by such Person as the Issuer shall designate. For the avoidance of doubt, calculation of the Applicable Premium shall not be an obligation or duty of the Trustee or Paying Agents.

“*Asset Disposition*” means, with respect to Altice International and the Restricted Subsidiaries (other than the Issuer), any direct or indirect sale, lease (other than an operating lease entered into in the ordinary course of business), transfer, issuance or other disposition, or a series of related sales, leases (other than operating leases entered into in the ordinary course of business), transfers, issuances or dispositions that are part of a common plan, of shares of Capital Stock of a Subsidiary (other than directors’ qualifying shares), property or other assets (each referred to for the purposes of this definition as a “disposition”) by Altice International or any of the Restricted Subsidiaries, including any disposition by means of a merger, consolidation or similar transaction; *provided* that the sale, lease, transfer, issuance or other disposition of all or substantially all of the assets of Altice International and the Restricted Subsidiaries taken as a whole will be governed by the provisions of the Indenture described above under the caption “Change of Control” and/or the provisions described above under the caption “—*Certain Covenants—Merger and Consolidation*” and not by the provisions described under the caption “—*Certain Covenants—Limitation on Sales of Assets and Subsidiary Stock*”. Notwithstanding the preceding provisions of this definition, the following items shall not be deemed to be Asset Dispositions:

- (1) a sale, lease, transfer, issuance or other disposition, or a series of related sales, leases, transfers, issuances or dispositions that are part of a common plan, by a Restricted Subsidiary to Altice International or by Altice International or a Restricted Subsidiary to a Restricted Subsidiary;
- (2) a sale, lease, transfer, issuance or other disposition, or a series of related sales, leases, transfers, issuances or dispositions that are part of a common plan, of cash, Cash Equivalents, Temporary Cash Investments or Investment Grade Securities;
- (3) a sale, lease, transfer, issuance or other disposition, or a series of related sales, leases, transfers, issuances or dispositions that are part of a common plan, of inventory, consumer equipment, trading stock, communications capacity or other assets in the ordinary course of business;
- (4) a sale, lease, transfer, issuance or other disposition, or a series of related sales, leases, transfers, issuances or dispositions that are part of a common plan, of obsolete, surplus or worn out equipment or other assets or equipment or other similar assets that are no longer useful in the conduct of the business of Altice International and its Restricted Subsidiaries;
- (5) transactions permitted under “—*Certain Covenants—Merger and Consolidation*” (other than as permitted under clause (C) of the first paragraph under “—*Certain Covenants—Merger and Consolidation—The Subsidiary Guarantors*” and clause (C) of the first paragraph under “—*Certain Covenants—Merger and Consolidation—The HOT Proceeds Note Obligors*”), or a transaction that constitutes a Change of Control;
- (6) an issuance of Capital Stock by a Restricted Subsidiary to Altice International or to another Restricted Subsidiary or as part of or pursuant to an equity incentive or compensation plan approved by the Board of Directors of Altice International;
- (7) (a) any sale, lease, transfer, issuance or other disposition, or any series of related sales, leases, transfers, issuances or dispositions that are part of a common plan, of Capital Stock, properties or assets in a single transaction or series of related transactions with a fair market value (as determined in good faith by the Issuer) not to exceed the greater of €125 million and 1.0% of Total Assets or (b) a transfer of Capital Stock of HOT pursuant to the exercise of a Minority Shareholder Call Option as in effect on December 12, 2012;
- (8) (i) any Restricted Payment that is permitted to be made under the covenant described above under “—*Certain Covenants—Limitation on Restricted Payments*” or (ii) solely for the purposes of the third paragraph under “—*Certain Covenants—Limitation on Sale of Assets and Subsidiary Stock*”, a disposition, the proceeds of which are used to make Restricted Payments permitted to be made under the covenant described above under “—*Certain Covenants—Limitation on Restricted Payments*”;

- (9) the granting of Liens not prohibited by the covenant described above under the caption “—*Certain Covenants—Limitation on Liens*”;
- (10) a sale, lease, transfer, issuance or other disposition, or a series of related sales, leases, transfers, issuances or dispositions that are part of a common plan, of receivables in connection with the compromise, settlement or collection thereof in the ordinary course of business or in bankruptcy or similar proceedings and exclusive of factoring or similar arrangements;
- (11) the licensing or sublicensing of intellectual property or other general intangibles and licenses, sublicenses, leases, subleases of other property, in each case, in the ordinary course of business;
- (12) foreclosure, condemnation or any similar action with respect to any property or other assets;
- (13) the sale or discount (with or without recourse, and on customary or commercially reasonable terms) of accounts receivable or notes receivable arising in the ordinary course of business, or the conversion or exchange of accounts receivable for notes receivable;
- (14) sales, transfers or dispositions of receivables in connection with any Qualified Receivables Financing or any factoring transaction or in the ordinary course of business;
- (15) any sale, lease, transfer, issuance or other disposition, or any series of related sales, leases, transfers, issuances or dispositions that are part of a common plan, of Capital Stock, Indebtedness or other securities of an Unrestricted Subsidiary;
- (16) any sale, lease, transfer, issuance or other disposition, or any series of related sales, leases, transfers, issuances or dispositions that are part of a common plan, of Capital Stock of a Restricted Subsidiary pursuant to an agreement or other obligation with or to a Person (other than Altice International or a Restricted Subsidiary) from whom such Restricted Subsidiary was acquired, or from whom such Restricted Subsidiary acquired its business and assets (having been newly formed in connection with such acquisition), made as part of such acquisition and in each case comprising all or a portion of the consideration in respect of such sale or acquisition;
- (17) any surrender or waiver of contract rights or the settlement, release or surrender of contract, tort or other claims of any kind;
- (18) any sale, lease, transfer, issuance or other disposition, or any series of related sales, leases, transfers, issuances or dispositions that are part of a common plan, of assets to a Person who is providing services related to such assets, the provision of which have been or are to be outsourced by Altice International or any Restricted Subsidiary to such Person; *provided, however*, that the Board of Directors of Altice International shall certify that in the opinion of the Board of Directors, the outsourcing transaction will be economically beneficial to Altice International and the Restricted Subsidiaries (considered as a whole) ;
- (19) any sale, lease, transfer, issuance or other disposition, or any series of related sales, leases, transfers, issuances or dispositions that are part of a common plan, with respect to property built, owned or otherwise acquired by Altice International or any Restricted Subsidiary pursuant to customary sale and lease-back transactions, asset securitizations and other similar financings permitted by the Indenture; *provided* that network assets of Altice International or any Restricted Subsidiary shall be excluded from this clause (19) unless the Net Cash Proceeds of such sale and leaseback transaction are applied in accordance with the second paragraph of the covenant described under “*Certain Covenants—Limitation on Sales of Assets and Subsidiary Stock*”; and
- (20) any sale, lease, transfer, conveyance or other disposition in one or a series of related transactions of any assets of Altice International and its Subsidiaries or of any Person that becomes a Restricted Subsidiary (including the Target and its Subsidiaries (including the Capital Stock of the Target or any Subsidiary of Altice International or the Target)) that is required pursuant to Competition Laws in relation to the Acquisition or is taken to avoid or eliminate any impediment under Competition Laws in relation to the Acquisition (including, without limitation, in response to any actions initiated by an administrative, regulatory or other governmental authority or private party under Competition Laws) to the extent that the fair market value of any such sold, leased, transferred, conveyed or disposed of assets does not exceed 2.0% of Total Assets (on a pro forma consolidated basis, including, without limitation, the Target and its Subsidiaries that are Restricted Subsidiaries).

“*Associate*” means (i) any Person engaged in a Similar Business of which Altice International or a Restricted Subsidiary are the legal and beneficial owners of between 20% and 50% of all outstanding Voting Stock and (ii) any joint venture engaged in a Similar Business entered into by Altice International or any Restricted Subsidiary.

“*AWE Proceeds Loans*” refers to the proceeds loans made by Altice Holdings to Altice West Europe in connection with the Transactions.

“*Beneficial Owner*” has the meaning assigned to such term in Rule 13d-3 and Rule 13d-5 under the U.S. Exchange Act, except that in calculating the beneficial ownership of any particular “person” (as that term is used in Section 13(d)(3) of the Exchange Act), such “person” will be deemed to have beneficial ownership of all securities that such “person” has the right to acquire by conversion or exercise of other securities, whether such right is currently exercisable or is exercisable only after the passage of time. The terms “Beneficially Owns” and “Beneficially Owned” have a corresponding meaning.

“*Board of Directors*” means (1) with respect to the Issuer or any corporation, the board of directors or managers, as applicable, of the corporation, or any duly authorized committee thereof; (2) with respect to any partnership, the board of directors or other governing body of the general partner of the partnership or any duly authorized committee thereof; and (3) with respect to any other Person, the board or any duly authorized committee of such Person serving a similar function. Whenever any provision of the Indenture requires any action or determination to be made by, or any approval of, a Board of Directors, such action, determination or approval shall be deemed to have been taken or made if approved by a majority of the directors on any such Board of Directors (whether or not such action or approval is taken as part of a formal board meeting or as a formal board approval).

“*Bund Rate*” means, with respect to any redemption date, the rate per annum equal to the semi-annual equivalent yield to maturity as of such date of the Comparable German Bund Issue, assuming a price for the Comparable German Bund Issue (expressed as a percentage of its principal amount) equal to the Comparable German Bund Price for such redemption date, where:

- (1) “Comparable German Bund Issue” means the German Bundesanleihe security selected by any Reference German Bund Dealer as having a fixed maturity most nearly equal to the period from such redemption date to February 15, 2018 and that would be utilized at the time of selection and in accordance with customary financial practice, in pricing new issues of euro- denominated corporate debt securities in a principal amount approximately equal to the then outstanding principal amount of the Euro Notes and of a maturity most nearly equal to February 15, 2018; *provided, however*, that, if the period from such redemption date to February 15, 2018 is not equal to the fixed maturity of the German Bundesanleihe security selected by such Reference German Bund Dealer, the Bund Rate shall be determined by linear interpolation (calculated to the nearest one-twelfth of a year) from the yields of German Bundesanleihe securities for which such yields are given, except that if the period from such redemption date to February 15, 2018, is less than one year, a fixed maturity of one year shall be used;
- (2) “Comparable German Bund Price” means, with respect to any redemption date, the average of all Reference German Bund Dealer Quotations for such date (which, in any event, must include at least two such quotations), after excluding the highest and lowest such Reference German Bund Dealer Quotations, or if the Issuer obtains fewer than four such Reference German Bund Dealer Quotations, the average of all such quotations;
- (3) “Reference German Bund Dealer” means any dealer of German Bundesanleihe securities appointed by the Issuer in good faith; and
- (4) “Reference German Bund Dealer Quotations” means, with respect to each Reference German Bund Dealer and any redemption date, the average as determined by the Issuer in good faith of the bid and offered prices for the Comparable German Bund Issue (expressed in each case as a percentage of its principal amount) quoted in writing to the Issuer by such Reference German Bund Dealer at 3:30 p.m. Frankfurt, Germany, time on the third Business Day preceding the redemption date.

“*Business Day*” means each day that is not a Saturday, Sunday or other day on which banking institutions in London, United Kingdom, the Grand Duchy of Luxembourg or New York, New York, United States are authorized or required by law to close.

“*Cabovisao*” means Cabovisão—Televisão por Cabo, S.A., a public limited liability company (*sociedade anónima*) incorporated under the laws of Portugal.

“*Cabovisão Proceeds Notes*” refers to the outstanding bonds issued by Cabovisão and subscribed for by Altice Holdings on April 23, 2013 and on July 2, 2013.

“*Cabovisão Security*” refers to the security interests governed by Portuguese law created by Altice Holdings, Altice West Europe (if applicable), Altice Portugal and Cabovisão and as amended from time to time.

“*Capital Stock*” of any Person means any and all shares of, interests, rights to purchase, warrants or options for, participation or other equivalents of, or partnership or other interests in (however designated), equity of such Person, including any Preferred Stock, but excluding any debt securities convertible into such equity.

“*Capitalized Lease Obligations*” means an obligation that is required to be classified and accounted for as a capitalized lease for financial reporting purposes on the basis of IFRS. The amount of Indebtedness will be, at the time any determination is to be made, the amount of such obligation required to be capitalized on a balance sheet (excluding any notes thereto) prepared in accordance with IFRS, and the stated maturity thereof will be the date of the last payment of rent or any other amount due under such lease prior to the first date such lease may be terminated without penalty. For the avoidance of doubt, operating leases will not be deemed Capitalized Lease Obligations.

“*Cash Equivalents*” means:

- (1) securities issued or directly and fully Guaranteed or insured by the United States Government, the State of Israel, the United Kingdom, Switzerland or any member state of the European Union, in each case, any agency or instrumentality of thereof (*provided* that the full faith and credit of such country or such member state is pledged in support thereof), having maturities of not more than two years from the date of acquisition;
- (2) certificates of deposit, time deposits, eurodollar time deposits, overnight bank deposits or bankers’ acceptances having maturities of not more than one year from the date of acquisition thereof issued by (i) any of Israel Discount Bank Ltd, Mizrahi Tefahot Bank Ltd, Bank Leumi of Israel or Bank Hapoalim Ltd or (ii) a bank or trust company (a) whose commercial paper is rated at least “A-1” or the equivalent thereof by S&P or at least “P-1” or the equivalent thereof by Moody’s (or if at the time neither is issuing comparable ratings, then a comparable rating of another Nationally Recognized Statistical Rating Organization) or (b) (in the event that such bank or trust company does not have commercial paper which is rated) having combined capital and surplus in excess of € 500 million;
- (3) repurchase obligations with a term of not more than 30 days for underlying securities of the types described in clauses (1) and (2) entered into with any bank meeting the qualifications specified in clause (2) above;
- (4) commercial paper rated at the time of acquisition thereof at least “A-2” or the equivalent thereof by S&P or “P-2” or the equivalent thereof by Moody’s or carrying an equivalent rating by a Nationally Recognized Statistical Rating Organization, if both of the two named rating agencies cease publishing ratings of investments or, if no rating is available in respect of the commercial paper, the issuer of which has an equivalent rating in respect of its long-term debt, and in any case maturing within one year after the date of acquisition thereof;
- (5) readily marketable direct obligations issued by any state of the United States of America, any member of the European Union or any political subdivision thereof, in each case, having one of the two highest rating categories obtainable from either Moody’s or S&P (or, if at the time, neither is issuing comparable ratings, then a comparable rating of another Nationally Recognized Statistical Rating Organization) with maturities of not more than two years from the date of acquisition;
- (6) Indebtedness or preferred stock issued by Persons with a rating of “BBB-” or higher from S&P or “Baa3” or higher from Moody’s (or, if at the time, neither is issuing comparable ratings, then a comparable rating of another Nationally Recognized Statistical Rating Organization) with maturities of 12 months or less from the date of acquisition;
- (7) bills of exchange issued in the United States, a member state of the European Union, eligible for rediscount at the relevant central bank and accepted by a bank (or any dematerialized equivalent); and
- (8) interests in any investment company, money market or enhanced high yield fund which invests 95% or more of its assets in instruments of the type specified in clauses (1) through (7) above.

“*Change of Control*” means:

- (1) the consummation of any transaction (including, without limitation, any merger or consolidation), the result of which is that any Person (including any “person” (as that term is used in Section 13(d)(3) of the Exchange Act)) other than one or more Permitted Holders becomes the Beneficial Owner, directly or indirectly, of more than 50% of the issued and outstanding Voting Stock of Altice International, measured by voting power rather than number of shares;
- (2) during any period of two consecutive years, individuals who at the beginning of such period constituted the majority of the directors on the Board of Directors of Altice S.A. (together with any new directors whose

election by the majority of such directors on such Board of Directors of Altice S.A. or whose nomination for election by shareholders of Altice S.A., as applicable, was approved by a vote of the majority of such directors on the Board of Directors of Altice S.A. then still in office who were either directors at the beginning of such period or whose election or nomination for election was previously so approved) ceased for any reason to constitute the majority of the directors on the Board of Directors of Altice S.A., then in office;

- (3) the direct or indirect sale, lease, transfer, conveyance or other disposition (other than by way of merger, consolidation or other business combination transaction), in one or a series of related transactions, of all or substantially all of the assets of Altice International and its Restricted Subsidiaries, taken as a whole, to a Person (including any “person” as defined above), other than a Permitted Holder; *provided* that a Change of Control shall be deemed not to have occurred as a result of the sale, lease, transfer, conveyance or other disposition in one or a series of related transactions of any assets of Altice International and its Subsidiaries or the Target and its Subsidiaries (including the Capital Stock of the Target or any Subsidiary of Altice International or the Target) that is required pursuant to Competition Laws in relation to the Acquisition or is taken to avoid or eliminate any impediment under Competition Laws in relation to the Acquisition (including, without limitation, in response to any actions initiated by an administrative, regulatory or other governmental authority or private party under Competition Laws); *provided further* that, solely to the extent Altice International is relying on this provision as an exemption from the requirement to make a Change of Control Offer, in the event the fair market value of any such sold, leased, transferred, conveyed or disposed of assets exceeds 2.0% of the Total Assets of Altice International and its Restricted Subsidiaries (on a pro forma consolidated basis, including, without limitation, the Target and its Subsidiaries that are Restricted Subsidiaries), (i) the Consolidated Net Leverage Ratio of Altice International and its Restricted Subsidiaries (on a pro forma consolidated basis, including, without limitation, the Target and its Subsidiaries that are Restricted Subsidiaries and taking into account any repayment or repurchase of Indebtedness pursuant to clause (ii)) shall not increase; and (ii) the Issuer shall promptly make an offer to all holders of the Existing Term Loans and, to the extent required by the terms of any Pari Passu Indebtedness that is not Public Debt, any such Pari Passu Indebtedness to repay or repurchase such Existing Term Loans and Pari Passu Indebtedness at a price of 100% of the principal amount thereof plus accrued and unpaid interest thereon to the date of redemption in an amount equal to the Net Cash Proceeds of such sale, lease, transfer, conveyance or other disposition (on a *pro rata* basis on the basis of the aggregate principal amount of tendered Existing Term Loans or Pari Passu Indebtedness) and in the event the principal amount of Pari Passu Indebtedness tendered is less than the amount of such Net Cash Proceeds, the Issuer shall apply any such remaining proceeds to prepay an equal principal amount of the Existing Term Loans at par on a *pro rata* basis; or
- (4) the first day on which HoldCo fails to own, directly or indirectly, 100% of the Capital Stock of the Issuer or Altice International fails to own, directly or indirectly, 100% of the Capital Stock of HoldCo.

“*Change of Control Triggering Event*” means the occurrence of both a Change of Control and a Rating Decline with respect to the Notes.

“*Coditel Holdco*” refers to Coditel Holding Lux II S.à r.l., a private limited liability company (*société à responsabilité limitée*) incorporated under the laws of Luxembourg.

“*Coditel Intercreditor Agreement*” means the intercreditor agreement, dated November 29, 2011, *inter alios*, Coditel Holding Lux S.a r.l., the companies listed therein as original debtors, ING Bank N.V. as senior agent, Wilmington Trust (London) Limited as mezzanine agent and ING Bank N.V. as security agent.

“*Coditel Security Documents*” means the security agreements, pledge agreements, collateral assignments, and any other instrument and document executed and delivered pursuant to the Coditel Senior Credit Facility or otherwise or any of the foregoing, as the same may be amended, supplemented or otherwise modified from time to time, creating the security interests in the Coditel Collateral as contemplated by the Coditel Senior Credit Facility.

“*Coditel Senior Credit Facility*” means senior facilities agreement, dated November 29, 2011, *inter alios*, Coditel Holding Lux S.a r.l. as parent, Coditel Holding as the company, GE Corporate Finance Bank S.A.S., HSBC France, ING Belgium SA/NV, KBC Bank NV and Natixis as mandated lead arrangers ING Bank N.V. as agent and security agent.

“*Commodity Hedging Agreements*” means, in respect of a Person, any commodity purchase contract, commodity futures or forward contract, commodities option contract or other similar contract (including commodities derivative agreements or arrangements), to which such Person is a party or a beneficiary.

“*Competition Laws*” means any federal, state, foreign, multinational or supranational antitrust, competition or trade regulation statutes, rules, regulations, orders, decrees, administrative and judicial doctrines and other laws that are designed or intended to prohibit, restrict or regulate actions or transactions having the purpose or effect of

monopolization or restraint of trade or lessening of competition through merger or acquisition or effectuating foreign investment.

“*Completion Date*” means the date on which the Acquisition is consummated.

“*Consolidated EBITDA*” for any period means, without duplication, the Consolidated Net Income for such period, plus the following to the extent deducted in calculating such Consolidated Net Income:

- (1) Consolidated Interest Expense and Receivables Fees;
- (2) Consolidated Income Taxes;
- (3) consolidated depreciation expense;
- (4) consolidated amortization and impairment expense;
- (5) any expenses, charges or other costs related to any Equity Offering, Investment, acquisition (including amounts paid in connection with the acquisition or retention of one or more individuals comprising part of a management team retained to manage the acquired business; *provided* that such payments are made in connection with such acquisition and are consistent with the customary practice in the industry at the time of such acquisition), disposition, recapitalization or the Incurrence of any Indebtedness permitted by the Indenture (whether or not successful) (including any such fees, expenses or charges related to the December 2013 Transactions, July 2013 Transactions, December 2012 Transactions, the Original Hot Transactions and the Transactions), in each case, as determined in good faith by the Issuer;
- (6) any minority interest expense (whether paid or not) consisting of income attributable to minority equity interests of third parties in such period or any prior period or any net earnings, income or share of profit of any Associates, associated company or undertaking;
- (7) the amount of management, monitoring, consultancy and advisory fees and related expenses paid in such period (or accruals relating to such fees and related expenses) to any Permitted Holder (whether directly or indirectly, through any Parent) to the extent permitted by the covenant described under “*Certain Covenants—Limitation on Affiliate Transactions*”; *provided* that any payments for such fees and related expense shall not be included in Consolidated EBITDA for any period to the extent they were accrued for in such period or any prior period and added back to Consolidated EBITDA in such period or any such prior period; and
- (8) other non-cash charges, write-downs or items reducing Consolidated Net Income (excluding any such non-cash charge, write-down or item to the extent it represents an accrual of or reserve for cash charges in any future period) or other non-cash items classified by Altice International as special items less other non-cash items of income increasing Consolidated Net Income (other than any non-cash items increasing such Consolidated Net Income pursuant to clauses (1) through (13) of the definition of Consolidated Net Income and excluding any such non-cash item of income to the extent it represents a receipt of cash in any future period);

provided that for purposes of clause (5)(c)(i) of the first paragraph of the covenant described under “*Certain Covenants—Limitation on Restricted Payments*” only, Consolidated EBITDA shall be the sum of the Consolidated EBITDA of (x) Cool and its Subsidiaries that are Restricted Subsidiaries for the period beginning on the first day of the first full fiscal quarter commencing prior to December 12, 2012 until the New Group Reference Date (defined below) and (y) Altice International and the Restricted Subsidiaries for the period beginning on the first day of the first full fiscal quarter commencing prior to July 2, 2013 (the “*New Group Reference Date*”) to the relevant date of determination.

“*Consolidated Income Taxes*” means taxes or other payments, including deferred Taxes, based on income, profits or capital of Altice International and the Restricted Subsidiaries whether or not paid, estimated, accrued or required to be remitted to any governmental authority.

“*Consolidated Interest Expense*” means, for any period (in each case, determined on the basis of IFRS), the consolidated net interest income/expense of Altice International and the Restricted Subsidiaries, whether paid or accrued, plus or including (without duplication) any interest, costs and charges consisting of:

- (1) interest expense attributable to Capitalized Lease Obligations;
- (2) amortization of debt discount, but excluding amortization of debt issuance costs, fees and expenses and the expensing of any bridge or other financing fees;

- (3) non-cash interest expense;
- (4) dividends or other distributions in respect of all Disqualified Stock of the Issuer and Altice International and all Preferred Stock of any Restricted Subsidiary, to the extent held by Persons other than Altice International or a Subsidiary of Altice International;
- (5) the consolidated interest expense that was capitalized during such period;
- (6) net payments and receipts (if any) pursuant to Hedging Obligations (other than Currency Agreements) (excluding unrealized mark-to-market gains and losses attributable to Hedging Obligations (other than Currency Agreements)); and
- (7) any interest actually paid by Altice International or any Restricted Subsidiary on Indebtedness of another Person that is guaranteed by Altice International or any Restricted Subsidiary or secured by a Lien on assets of Altice International or any Restricted Subsidiary;

provided that for purposes of clause (c)(i) of the first paragraph of the covenant described under “—*Certain Covenants—Limitation on Restricted Payments*” only, Consolidated Interest Expense shall be the sum of the Consolidated Interest Expense of (x) Cool and its Subsidiaries that are Restricted Subsidiaries for the period beginning on the first day of the first full fiscal quarter commencing prior to December 12, 2012 until the New Group Reference Date and (y) Altice International and the Restricted Subsidiaries for the period beginning on the New Group Reference Date to the relevant date of determination.

Notwithstanding any of the foregoing, Consolidated Interest Expense shall not include (i) any interest accrued, capitalized or paid in respect of Subordinated Shareholder Funding, (ii) any commissions, discounts, yield and other fees and charges related to a Qualified Receivables Financing, (iii) any payments on any operating leases, including without limitation any payments on any lease, concession or license of property (or Guarantee thereof) which would be considered an operating lease under IFRS as in effect on the Issue Date, (iv) net payments and receipts (if any) pursuant to Currency Agreements (excluding unrealized mark-to-market gains and losses attributable to Hedging Obligations), (v) any pension liability interest costs, and (vi) any interest expense related to a Guarantee of Indebtedness of HoldCo Incurred in compliance with the Indenture, *provided* that the interest expense of any HoldCo Proceeds Loan(s) related thereto is included in the calculation of Consolidated Interest Expense in an equal or greater amount.

“*Consolidated Net Income*” means, for any period, the net income (loss) of Altice International and the Restricted Subsidiaries determined on a consolidated basis on the basis of IFRS; *provided, however*, that there will not be included in such Consolidated Net Income:

- (1) subject to the limitations contained in clause (3) below, any net income (loss) of any Person if such Person is not a Restricted Subsidiary, except that Altice International’s equity in the net income of any such Person for such period will be included in such Consolidated Net Income up to the aggregate amount of cash or Cash Equivalents actually distributed by such Person during such period to Altice International or a Restricted Subsidiary as a dividend or other distribution or return on investment (subject, in the case of a dividend or other distribution or return on investment to a Restricted Subsidiary, to the limitations contained in clause (2) below);
- (2) solely for the purpose of determining the amount available for Restricted Payments under clause (c)(i) of the first paragraph of the covenant described under “—*Certain Covenants—Limitation on Restricted Payments*”, any net income (loss) of any Restricted Subsidiary that is not a Guarantor if such Subsidiary is subject to restrictions, directly or indirectly, on the payment of dividends or the making of distributions by such Restricted Subsidiary, directly or indirectly, to Altice International by operation of the terms of such Restricted Subsidiary’s charter or any agreement, instrument, judgment, decree, order, statute or governmental rule or regulation applicable to such Restricted Subsidiary or its shareholders (other than (a) restrictions that have been waived or otherwise released, (b) contractual or legal restrictions in effect on the Issue Date with respect to a Restricted Subsidiary (including pursuant to the agreements specified in clause (3) of the covenant described under “—*Certain Covenants—Limitation on Restrictions on Distributions from Restricted Subsidiaries*”), and other restrictions with respect to such Restricted Subsidiary that, taken as a whole, are not materially less favorable to the Holders than such restrictions in effect on the Issue Date, and (c) restrictions as in effect on the Issue Date specified in clause (12) of the second paragraph of the covenant described under “—*Certain Covenants—Limitation on Restrictions on Distributions from Restricted Subsidiaries*”) except that Altice International’s equity in the net income of any such Restricted Subsidiary for such period will be included in such Consolidated Net Income up to the aggregate amount of cash or Cash Equivalents or non-cash distributions to the extent converted into cash or Cash Equivalents actually distributed or that could have been distributed by such Restricted Subsidiary during such period to Altice International or another Restricted Subsidiary as a

dividend or other distribution (subject, in the case of a dividend to another Restricted Subsidiary, to the limitation contained in this clause);

- (3) any net gain (or loss) realized upon the sale, abandonment or other disposition of any asset or disposed operations of Altice International or any Restricted Subsidiary (including pursuant to any sale/ leaseback transaction) which is not sold or otherwise disposed of in the ordinary course of business (as determined in good faith by an Officer of the Issuer);
- (4) any extraordinary, exceptional, unusual or nonrecurring gain, loss, charge or expense or any charges, expenses or reserves in respect of any restructuring, redundancy or severance or any expenses, charges, reserves, gains or other costs related to the December 2012 Transactions, July 2013 Transactions, December 2013 Transactions or the Transactions;
- (5) the cumulative effect of a change in accounting principles;
- (6) any non-cash compensation charge or expense arising from any grant of stock, stock options or other equity based awards and any non-cash deemed finance charges in respect of any pension liabilities or other provisions;
- (7) all deferred financing costs written off and premiums paid or other expenses incurred directly in connection with any early extinguishment of Indebtedness and any net gain (loss) from any write-off or forgiveness of Indebtedness;
- (8) any unrealized gains or losses in respect of Hedging Obligations or other derivative instruments or any ineffectiveness recognized in earnings related to qualifying hedge transactions or the fair value or changes therein recognized in earnings for derivatives that do not qualify as hedge transactions, in each case, in respect of Hedging Obligations or other derivative instruments;
- (9) any unrealized foreign currency translation gains or losses in respect of Indebtedness of any Person denominated in a currency other than the functional currency of such Person and any unrealized foreign exchange gains or losses relating to translation of assets and liabilities denominated in foreign currencies;
- (10) any unrealized foreign currency translation or transaction gains or losses in respect of Indebtedness or other obligations of Altice International or any Restricted Subsidiary owing to Altice International or any Restricted Subsidiary;
- (11) any one-time non-cash charges or any increases in amortization or depreciation resulting from purchase accounting, in each case, in relation to any acquisition of another Person or business or resulting from any reorganization or restructuring involving Altice International or its Subsidiaries;
- (12) any goodwill or other intangible asset impairment charge or write-off; and
- (13) the impact of capitalized, accrued or accreting or pay-in-kind interest or principal on Subordinated Shareholder Funding.

“*Consolidated Net Leverage*” means (A) the sum, without duplication, of the aggregate outstanding Indebtedness of Altice International and its Restricted Subsidiaries on a consolidated basis (excluding (i) Hedging Obligations and (ii) other than for purposes of the covenant described under “—*Certain Covenants—Limitation on Restricted Payments*”, any Indebtedness Incurred pursuant to clause (1) under the second paragraph of the covenant described under “—*Certain Covenants—Limitation on Indebtedness*”); *provided* that any Guarantees by the Issuer and the Guarantors of Indebtedness of HoldCo permitted to be Incurred under clause (14), (15) or (16) of the second paragraph of the covenant entitled “—*Certain Covenants—Limitation on Indebtedness*” will be excluded from this definition of Consolidated Net Leverage to the extent an equal or greater aggregate amount of Indebtedness in respect of HoldCo Proceeds Loans outstanding on the relevant date of determination is included in this definition of Consolidated Net Leverage, less (B) the aggregate amount of cash and Cash Equivalents of Altice International and the Restricted Subsidiaries on a consolidated basis.

“*Consolidated Net Leverage Ratio*” means, as of any date of determination, the ratio of (x) Consolidated Net Leverage at such date to (y) the aggregate amount of Pro forma EBITDA for the period of the most recent two consecutive fiscal quarters ending prior to the date of such determination for which internal consolidated financial statements of Altice International are available multiplied by 2.0; *provided, however*, that the *pro forma* calculation of the Consolidated Net Leverage Ratio shall not give effect to (i) any Indebtedness incurred on the date of determination pursuant to the provisions described in the second paragraph under the caption “—*Certain Covenants—Limitation on Indebtedness*” or (ii) the discharge on the date of determination of any Indebtedness to the extent that such discharge results from the

proceeds incurred pursuant to the provisions described in the second paragraph under the caption “—*Certain Covenants—Limitation on Indebtedness*”.

For the avoidance of doubt, in determining Consolidated Net Leverage Ratio, no cash or Cash Equivalents shall be included that are the proceeds of Indebtedness in respect of which the calculation of the Consolidated Net Leverage Ratio is to be made.

“*Consolidated Net Senior Secured Leverage*” means (A) the sum of the aggregate outstanding Senior Secured Indebtedness of Altice International and its Restricted Subsidiaries (excluding (i) Hedging Obligations and (ii) other than for purposes of the covenant described under “—*Certain Covenants—Limitation on Restricted Payments*”, Indebtedness Incurred pursuant to clause (1) under the second paragraph of the covenant described under “—*Certain Covenants—Limitation on Indebtedness*”), less (B) the aggregate amount of cash and Cash Equivalents of Altice International and the Restricted Subsidiaries on a consolidated basis.

“*Consolidated Net Senior Secured Leverage Ratio*” means, as of any date of determination, the ratio of (x) Consolidated Net Senior Secured Leverage at such date to (y) the aggregate amount of Pro forma EBITDA for the period of the most recent two consecutive fiscal quarters ending prior to the date of such determination for which internal consolidated financial statements of Altice International are available multiplied by 2.0; *provided, however*, that the *pro forma* calculation of the Consolidated Net Senior Secured Leverage Ratio shall not give effect to (i) any Indebtedness incurred on the date of determination pursuant to the provisions described in the second paragraph under the caption “—*Certain Covenants—Limitation on Indebtedness*” or (ii) the discharge on the date of determination of any Indebtedness to the extent that such discharge results from the proceeds incurred pursuant to the provisions described in the second paragraph under the caption “—*Certain Covenants—Limitation on Indebtedness*”.

For the avoidance of doubt, in determining Consolidated Net Senior Secured Leverage Ratio, no cash or Cash Equivalents shall be included that are the proceeds of Indebtedness in respect of which the calculation of the Consolidated Net Senior Secured Leverage Ratio is to be made.

“*Contingent Obligations*” means, with respect to any Person, any obligation of such Person guaranteeing in any manner, whether directly or indirectly, any operating lease, dividend or other obligation that does not constitute Indebtedness (“primary obligations”) of any other Person (the “primary obligor”), including any obligation of such Person, whether or not contingent:

- (1) to purchase any such primary obligation or any property constituting direct or indirect security therefor;
- (2) to advance or supply funds:
 - (a) for the purchase or payment of any such primary obligation; or
 - (b) to maintain the working capital or equity capital of the primary obligor or otherwise to maintain the net worth or solvency of the primary obligor; or
- (3) to purchase property, securities or services primarily for the purpose of assuring the owner of any such primary obligation of the ability of the primary obligor to make payment of such primary obligation against loss in respect thereof.

“*Cool*” means Cool Holding Ltd., a public limited company (*société anonyme*) incorporated and existing under the laws of the State of Israel and the Grand Duchy of Luxembourg having its registered office at 3 Boulevard Royal, L-2449 Luxembourg, and registered with the Luxembourg Trade and Companies’ Register under number B152.495.

“*Cool Interest Loan*” means the interest free loan from Altice International to Cool in an amount equal to NIS 37 million.

“*Covenant Party Pledged Proceeds Loans*” has the meaning ascribed to it under “*Corporate and Financing Structure*” in this Offering Memorandum.

“*Credit Facility*” means, with respect to Altice International or any of its Subsidiaries, one or more debt facilities, arrangements, instruments, trust deeds, note purchase agreements or indentures or commercial paper facilities and overdraft facilities (including the Guarantee Facility, the Senior Credit Facilities and the Revolving Credit Facilities) with banks, institutions, funds or investors providing for revolving credit loans, term loans, receivables financing (including through the sale of receivables to such institutions or to special purpose entities formed to borrow from such institutions against such receivables), notes, bonds, debentures letters of credit or other Indebtedness, in each case, as amended, restated, modified, renewed, refunded, replaced, restructured, refinanced, repaid, increased or extended in whole or in

part from time to time (and whether in whole or in part and whether or not with the original administrative agent and lenders or another administrative agent or agents or trustees or other banks, institutions or investors and whether provided under one or more credit or other agreements, indentures, financing agreements or otherwise) and in each case including all agreements, instruments and documents executed and delivered pursuant to or in connection with the foregoing (including any notes and letters of credit issued pursuant thereto and any Guarantee and collateral agreement, patent and trademark security agreement, mortgages or letter of credit applications and other Guarantees, pledges, agreements, security agreements and collateral documents). Without limiting the generality of the foregoing, the term “Credit Facility” shall include any agreement or instrument (1) changing the maturity of any Indebtedness Incurred thereunder or contemplated thereby, (2) adding Subsidiaries of Altice International as additional borrowers or guarantors thereunder, (3) increasing the amount of Indebtedness Incurred thereunder or available to be borrowed thereunder or (4) otherwise altering the terms and conditions thereof.

“*Currency Agreement*” means, in respect of a Person, any foreign exchange contract, currency swap agreement, currency futures contract, currency option contract, cap, floor, ceiling, collar, currency derivative or other similar agreement to which such Person is a party or beneficiary.

“*December 2012 Senior Notes*” refers to the \$425 million aggregate principal amount of HoldCo’s 9⁷/₈% Senior Notes due 2020.

“*December 2012 Senior Notes Indenture*” means the indenture dated as of December 12, 2012, as amended, among, *inter alios*, HoldCo, as issuer, the guarantors party thereto and the trustee and security agent party thereto, governing the December 2012 Senior Notes.

“*December 2012 Senior Secured Notes*” refers to the \$460 million aggregate principal amount of the Issuer’s 7⁷/₈% Senior Secured Notes due 2019 and €210 million aggregate principal amount of the Issuer’s 8% Senior Secured Notes.

“*December 2012 Senior Secured Notes Indenture*” means the indenture dated as of December 12, 2012, as amended, restated, supplemented or otherwise modified from time to time, among, *inter alios*, the Issuer, as issuer, the guarantors party thereto and the trustee and the security agent party thereto, governing the December 2012 Senior Secured Notes.

“*December 2012 Transactions*” means the Take-Private Transaction and the related refinancings and financings consummated on December 27, 2012.

“*December 2013 Senior Notes*” refers to the \$400 million aggregate principal amount of HoldCo’s 8¹/₈% Senior Notes due 2024 issued on December 12, 2013.

“*December 2013 Senior Notes Indenture*” means the indenture dated as of December 12, 2013, as amended, restated, supplemented or otherwise modified from time to time, among, *inter alios*, HoldCo, as issuer, the guarantors party thereto and the trustee party thereto, governing the December 2013 Senior Notes.

“*December 2013 Senior Secured Notes*” refers to the \$900 million aggregate principal amount of the Issuer’s 6¹/₂% Senior Secured Notes due 2022 and €300 million aggregate principal amount of the Issuer’s 6¹/₂% Senior Secured Notes, in each case, issued on December 12, 2013.

“*December 2013 Senior Secured Notes Indenture*” means the indenture dated as of December 12, 2013, as amended, restated, supplemented or otherwise modified from time to time, among, *inter alios*, the Issuer, as issuer, the guarantors party thereto and the trustee and the security agent party thereto, governing the December 2013 Senior Secured Notes.

“*December 2013 Transactions*” refers to the acquisition of Orange Dominicana (which was consummated on April 9, 2014), the acquisition of the Tricom Entities (which was consummated on March 12, 2014), and the related issuance of the December 2013 Senior Notes and the December 2013 Senior Secured Notes.

“*Default*” means any event which is, or after giving notice or with the passage of time or both would be, an Event of Default.

“*Designated Non-Cash Consideration*” means the fair market value (as determined in good faith by the Issuer) of non-cash consideration received by Altice International or a Restricted Subsidiary in connection with an Asset Disposition that is so designated as Designated Non-Cash Consideration pursuant to an Officer’s Certificate, setting forth the basis of such valuation, less the amount of cash, Cash Equivalents or Temporary Cash Investments received in connection with a subsequent payment, redemption, retirement, sale or other disposition of such Designated Non-Cash Consideration. A particular item of Designated Non-Cash Consideration will no longer be considered to be outstanding when and to the extent it has been paid, redeemed or otherwise retired or sold or otherwise disposed of in compliance with the covenant described under “—*Certain Covenants—Limitation on Sales of Assets and Subsidiary Stock*”.

“*Designated Preference Shares*” means, with respect to Altice International, Preferred Stock (other than Disqualified Stock) (a) that is issued for cash (other than to Altice International or a Subsidiary of Altice International or an employee stock ownership plan or trust established by Altice International or any such Subsidiary for the benefit of their employees to the extent funded by Altice International or such Subsidiary) and (b) that is designated as “Designated Preference Shares” pursuant to an Officer’s Certificate of the Issuer at or prior to the issuance thereof, the Net Cash Proceeds of which are excluded from the calculation set forth in clause (c)(ii) of the first paragraph of the covenant described under “—*Certain Covenants—Limitation on Restricted Payments*”.

“*Direct Obligation Event*” means the HOT Direct Obligation event and/or the OMT Direct Obligation Event, as applicable.

“*Disinterested Director*” means, with respect to any Affiliate Transaction, a member of the Board of Directors of Altice International having no material direct or indirect financial interest in or with respect to such Affiliate Transaction. A member of the Board of Directors of Altice International shall be deemed not to have such a financial interest by reason of such member’s holding Capital Stock of Altice International or any Parent or any options, warrants or other rights in respect of such Capital Stock.

“*Disqualified Stock*” means, with respect to any Person, any Capital Stock of such Person which by its terms (or by the terms of any security into which it is convertible or for which it is exchangeable) or upon the happening of any event:

- (1) matures or is mandatorily redeemable for cash or in exchange for Indebtedness pursuant to a sinking fund obligation or otherwise;
- (2) is convertible or exchangeable for Indebtedness or Disqualified Stock (excluding Capital Stock which is convertible or exchangeable solely at the option of Altice International or a Restricted Subsidiary); or
- (3) is or may become (in accordance with its terms) upon the occurrence of certain events or otherwise redeemable or repurchasable for cash or in exchange for Indebtedness at the option of the holder of the Capital Stock in whole or in part,

in each case, on or prior to the earlier of (a) the Stated Maturity of the Notes or (b) the date on which there are no Notes outstanding; *provided, however*, that (i) only the portion of Capital Stock which so matures or is mandatorily redeemable, is so convertible or exchangeable or is so redeemable at the option of the holder thereof prior to such date will be deemed to be Disqualified Stock and (ii) any Capital Stock that would constitute Disqualified Stock solely because the holders thereof have the right to require Altice International to repurchase such Capital Stock upon the occurrence of a change of control or asset sale (howsoever defined or referred to) shall not constitute Disqualified Stock if any such redemption or repurchase obligation is subject to compliance by the relevant Person with the covenant described under “—*Certain Covenants—Limitation on Restricted Payments*”.

“*Equity Offering*” means a public or private sale of (x) Capital Stock of Altice International or (y) Capital Stock or other securities, the proceeds of which are contributed as Subordinated Shareholder Funding or to the equity of Altice International or any of its Restricted Subsidiaries, in each case other than:

- (1) Disqualified Stock;
- (2) Designated Preference Shares;
- (3) offerings registered on Form S-8 (or any successor form) under the Securities Act or any similar offering in other jurisdictions;
- (4) any such sale to an Affiliate of Altice International, including the Issuer, Altice International or a Restricted Subsidiary;
- (5) any such sale that constitutes an Excluded Contribution; and
- (6) the AI Mandatory Convertible Notes.

“*Escrow Agent*” means Deutsche Bank AG, London Branch.

“*Escrow Agreements*” means the New Senior Notes Escrow Agreement and the Notes Escrow Agreement.

“*Escrow Assignments*” means the grant of security interests in the Escrow Accounts and the Issuer’s rights under the Notes Escrow Agreement on the Issue Date to the Trustee for the benefit of the Holders of the relevant series of Notes.

“*Escrowed Proceeds*” means the proceeds from the offering of any debt securities or other Indebtedness paid into an escrow account with an independent escrow agent on the date of the applicable offering or Incurrence pursuant to escrow arrangements that permit the release of amounts on deposit in such escrow account upon satisfaction of certain conditions or the occurrence of certain events. The term “Escrowed Proceeds” shall include any interest earned on the amounts held in escrow.

“*euro*” or “€” means the currency introduced at the start of the third stage of the European economic and monetary union pursuant to the Treaty establishing the European Community, as amended by the Treaty on European Union.

“*Euro Equivalent*” means, with respect to any monetary amount in a currency other than euro (“*Other Currency*”), at any time of determination thereof by the Issuer or the Trustee, the amount of euros obtained by converting such Other Currency involved in such computation into euros at the spot rate for the purchase of euros with the Other Currency as published in *The Financial Times* in the “Currency Rates” section (or, if *The Financial Times* is no longer published, or if such information is no longer available in *The Financial Times*, such source as may be selected in good faith by the Issuer) on the date of such determination.

“*European Government Obligations*” means direct obligations of, or obligations guaranteed by, a member state of the European Monetary Union as of the date of the Indenture, and the payment for which such member state of the European Monetary Union pledges its full faith and credit; provided that such member state has a long-term government debt rating of “A1” or higher by Moody’s or A+ or higher by S&P or the equivalent rating category of another internationally recognized rating agency.

“*Exchange Act*” means the U.S. Securities Exchange Act of 1934, as amended, and the rules and regulations of the SEC promulgated thereunder, as amended.

“*Excluded Contribution*” means Net Cash Proceeds or property or assets received by Altice International as capital contributions to the equity (other than through the issuance of Disqualified Stock or Designated Preference Shares of Altice International) after the Issue Date or from the issuance or sale (other than to Altice International, a Restricted Subsidiary or an employee stock ownership plan or trust established by Altice International or any Subsidiary of Altice International for the benefit of its employees to the extent funded by Altice International or any Restricted Subsidiary) of Capital Stock (other than Disqualified Stock, Designated Preference Shares) or Subordinated Shareholder Funding of Altice International, in each case, to the extent designated as an Excluded Contribution pursuant to an Officer’s Certificate of the Issuer.

“*Existing ASA Notes*” refers to the \$2,900 million aggregate principal amount of Altice S.A.’s 7³/₄% Senior Notes due 2022 and €2,075 million aggregate principal amount of Altice S.A.’s 7¹/₄% Senior Notes, in each case, issued on May 8, 2013.

“*Existing ASA Revolving Credit Facility*” means the revolving credit facility agreement dated on or around May 8, 2013, as amended, restated, supplemented or otherwise modified from time to time, between, *inter alia*, Altice S.A., certain financial institutions party thereto and Deutsche Bank AG, London Branch as facility agent and Deutsche Bank AG, London Branch, as security agent.

“*Existing HOT Unsecured Notes*” refers to the NIS 825 million notes (Series A) and the NIS 675 million notes (Series B) of HOT, offered to the Israeli investors pursuant to an Israeli shelf offering report dated March 29, 2011 under an Israeli shelf prospectus dated February 28, 2011, as amended on March 29, 2011, and as shall be amended from time to time.

“*Existing Revolving Credit Facilities*” means (i) that certain agreement dated November 27, 2012, as amended, restated, supplemented or otherwise modified from time to time, between, *inter alia*, the Issuer, the Company, certain financial institutions party thereto and Citibank International plc as facility agent and security agent, as amended and (ii) the 2013 Revolving Credit Facility.

“*Existing Senior Credit Facility*” means the term loan credit agreement dated June 24, 2013 between the Issuer as borrower and the persons listed in Schedule 2.01 thereto as lenders, Goldman Sachs Lending Partners LLC as the Administrative Agent and Citibank, N.A., London Branch as Security Agent, as amended.

“*Existing Senior Notes*” means the December 2013 Senior Notes, the July 2013 Senior Notes and the December 2012 Senior Notes.

“*Existing Senior Notes Indentures*” means the December 2013 Senior Notes Indenture, the July 2013 Senior Notes Indenture and the December 2012 Senior Notes Indenture.

“*Existing Senior Secured Notes*” means the December 2013 Senior Secured Notes and the December 2012 Senior Secured Notes.

“*Existing Senior Secured Notes Indentures*” means the December 2013 Senior Secured Notes Indenture and the December 2012 Senior Secured Notes Indenture.

“*Existing Term Loans*” means the term loans extended to the Issuer pursuant to the Existing Senior Credit Facility.

“*fair market value*” wherever such term is used in this “Description of Senior Secured Notes” or the Indenture (except in relation to an enforcement action pursuant to the Intercreditor Agreement and except as otherwise specifically provided in this “Description of Senior Secured Notes” or the Indenture), may be conclusively established by means of an Officer’s Certificate or a resolution of the Board of Directors of Altice International setting out such fair market value as determined by such Officer or such Board of Directors in good faith.

“*Global Interlink*” means Global Interlink Ltd., a private limited company incorporated under the laws of the Bahamas.

“*Green*” means green.ch AG (company registration no. CHE- 112.574.742; formerly Solution25AG), a Swiss company limited by shares (*Aktiengesellschaft*), incorporated and existing under the laws of Switzerland.

“*Green Datacenter*” means Green Datacenter AG (company registration no. CHE-115.555.342), a Swiss company limited by shares (*Aktiengesellschaft*) incorporated and existing under the laws of Switzerland.

“*Group*” means Altice International and its Subsidiaries.

“*Guarantee*” means any obligation, contingent or otherwise, of any Person directly or indirectly guaranteeing any Indebtedness of any other Person, including any such obligation, direct or indirect, contingent or otherwise, of such Person:

- (1) to purchase or pay (or advance or supply funds for the purchase or payment of) such Indebtedness of such other Person (whether arising by virtue of partnership arrangements, or by agreements to keep-well, to purchase assets, goods, securities or services, to take-or-pay or to maintain financial statement conditions or otherwise); or
- (2) entered into primarily for purposes of assuring in any other manner the obligee of such Indebtedness of the payment thereof or to protect such obligee against loss in respect thereof (in whole or in part),

provided, however, that the term “Guarantee” will not include endorsements for collection or deposit in the ordinary course of business or any guarantee of performance. The term “Guarantee” used as a verb has a corresponding meaning.

“*Guarantee Facility*” means the guarantee facility agreement dated July 1, 2013, as amended, restated, supplemented or otherwise modified from time to time, among the Issuer as borrower, the lenders from time to time party thereto, Citibank International Plc as facility agent and Citibank, N.A., London Branch as Security Agent.

“*Guarantor*” means (i) as of the Completion Date, the Completion Date Guarantors, (ii) as of the Post-Completion Guarantor Accession Date, the Completion Date Guarantors and the Post-Completion Date Guarantors and (iii) each Person that executes a Note Guarantee in accordance with the provisions of the Indenture in its capacity as a guarantor of the Notes and its respective successors and assigns, until the Note Guarantee of such Person has been released in accordance with the provisions of the Indenture.

“*Hedging Obligations*” of any Person means the obligations of such Person pursuant to any Interest Rate Agreement, Currency Agreement or Commodity Hedging Agreement.

“*HoldCo*” means Altice Finco S.A., a Luxembourg public limited liability company (*société anonyme*).

“*HoldCo Proceeds Loan*” means any loan agreement entered into between HoldCo and the Issuer pursuant to which HoldCo lends to the Issuer all or substantially all of the net proceeds of any Incurrence of Indebtedness by HoldCo; *provided that* (i) the principal amount of, and interest rate on, such HoldCo Proceeds Loan will not be greater than the principal amount of, and interest rate on, the Indebtedness of HoldCo that funded such HoldCo Proceeds Loan (except to the extent a reasonable margin is required by law), (ii) a Lien over such HoldCo Proceeds Loan is granted at the time of

its Incurrence on a senior basis to secure the Notes and the Note Guarantees, (iii) any Lien over such HoldCo Proceeds Loan that secures the Indebtedness of HoldCo will be junior to the Lien over such HoldCo Proceeds Loan granted to secure the Notes and the Note Guarantees and (iv) such HoldCo Proceeds Loan shall be subject to the Intercreditor Agreement and any Additional Intercreditor Agreement.

“*Holder*” means each Person in whose name the Notes are registered.

“*HOT Credit Facility*” means the Facility Agreement dated April 25, 2013 between and made between (among others) HOT and HSBC Bank plc, Israel Discount Bank Ltd. and First International Bank of Israel Ltd. in their respective capacities as Lenders.

“*HOT Direct Obligation Event*” means the election by Altice International to cause the HOT Proceeds Note Obligors to become direct Guarantors of the Notes by causing each of them to provide a Guarantee of the Notes on a senior basis and grant an equivalent Lien over all of its assets; *provided* that where a Guarantee by a Restricted Subsidiary of HOT could reasonably be expected to give rise to or result in: (1) any violation of applicable law or regulation; (2) any liability for the officers, directors or (except in the case of a Restricted Subsidiary that is a partnership) shareholders of such Restricted Subsidiary (or, in the case of a Restricted Subsidiary that is a partnership, directors or shareholders of the partners of such partnership); (3) any cost, expense, liability or obligation (including with respect to any Taxes) other than reasonable out-of-pocket expenses and other than reasonable expenses incurred in connection with any governmental or regulatory filings required as a result of, or any measures pursuant to clause (1) hereof undertaken in connection with, such Guarantee, which in any case under any of clauses (1), (2) and (3) of this paragraph cannot be avoided through measures reasonably available to Altice International, HOT or such Restricted Subsidiary; or (4) such Restricted Subsidiary is prohibited from Incurring such Guarantee by the terms of any Indebtedness of such Restricted Subsidiary that is not prepayable without a prepayment premium (in each case, other than Indebtedness Incurred to provide all or any portion of the funds utilized to consummate the transaction or series of related transactions pursuant to which such Person became a Restricted Subsidiary) (*provided* that this clause (4) applies only for so long as such prepayment premium applies to such Indebtedness), such Restricted Subsidiary shall be excluded from the requirement to provide such Guarantee and grant a Lien over its assets as a condition to the consummation of the HOT Direct Obligation Event.

“*HOT Mobile*” means HOT Mobile Ltd., formerly known as MIRS Communications Ltd.

“*HOT Proceeds Note Obligors*” means HOT and the HOT Proceeds Note Guarantors.

“*HOT Proceeds Note*” means collectively, the proceeds term loan and the revolving facility proceeds loan made by the Issuer to HOT on December 27, 2012.

“*HOT Proceeds Note Documents*” means the HOT Proceeds Note and the HOT Security Documents.

“*HOT Proceeds Note Guarantee*” means the guarantee by each HOT Proceeds Note Guarantor of HOT’s obligations under the HOT Proceeds Note, executed pursuant to the provisions thereof and the Existing Senior Secured Notes Indenture.

“*HOT Proceeds Note Guarantor*” means each Person that accedes to the HOT Proceeds Note as a HOT Proceeds Note Guarantor in accordance with the provisions of the HOT Proceeds Notes and the Indenture in its capacity as a guarantor of the HOT Proceeds Note and its respective successors and assigns, until the HOT Proceeds Note Guarantee of such Person has been released in accordance with the provisions of the Indenture.

“*HOT Security Documents*” means the security agreements, pledge agreements, collateral assignments, and any other instrument and document executed and delivered pursuant to the HOT Proceeds Note or otherwise or any of the foregoing, as the same may be amended, supplemented or otherwise modified from time to time, creating the security interests in the HOT Proceeds Note Collateral as contemplated by the Indenture and the HOT Proceeds Note.

“*IFRS*” means International Financial Reporting Standards as issued by the International Accounting Standards Board or any successor board or agency as endorsed by the European Union and in effect on the date hereof, or, with respect to the covenant described under the caption “Reports” as in effect from time to time; *provided that* at any date after the Issue Date, Altice International may make an irrevocable election to establish that “IFRS” shall mean IFRS as in effect on a date that is on or prior to the date of such election.

“*Incur*” means issue, create, assume, enter into any Guarantee of, incur, extend or otherwise become liable for; *provided, however,* that any Indebtedness or Capital Stock of a Person existing at the time such Person becomes a Restricted Subsidiary (whether by merger, consolidation, acquisition or otherwise) will be deemed to be Incurred by Altice International or such Restricted Subsidiary at the time it becomes a Restricted Subsidiary and the terms “*Incurred*” and

“*Incurrence*” have meanings correlative to the foregoing and any Indebtedness pursuant to any Credit Facility, bridge facility, revolving credit or similar facility shall only be “Incurred” at the time any funds are borrowed thereunder.

“*Indebtedness*” means, with respect to any Person on any date of determination (without duplication):

- (1) the principal of indebtedness of such Person for borrowed money;
- (2) the principal of obligations of such Person evidenced by bonds, debentures, notes or other similar instruments;
- (3) all reimbursement obligations of such Person in respect of letters of credit, bankers’ acceptances or other similar instruments (the amount of such obligations being equal at any time to the aggregate then undrawn and unexpired amount of such letters of credit or other instruments plus the aggregate amount of drawings thereunder that have not been reimbursed) (except to the extent such reimbursement obligations relate to trade payables and such obligations are satisfied within 30 days of Incurrence), in each case only to the extent that the underlying obligation in respect of which the instrument was issued would be treated as Indebtedness;
- (4) the principal component of all obligations of such Person to pay the deferred and unpaid purchase price of assets acquired or services supplied (except trade payables), which purchase price is due more than one year after the date of placing such property in service or taking final delivery and title thereto;
- (5) [Reserved];
- (6) the principal component of all obligations, or liquidation preference, of such Person with respect to any Disqualified Stock or, with respect to any Restricted Subsidiary, any Preferred Stock (but excluding, in each case, any accrued dividends);
- (7) the principal component of all Indebtedness of other Persons secured by a Lien on any asset of such Person, whether or not such Indebtedness is assumed by such Person; *provided, however*, that the amount of such Indebtedness will be the lesser of (a) the fair market value of such asset at such date of determination (as determined in good faith by the Issuer) and (b) the amount of such Indebtedness of such other Persons;
- (8) Guarantees by such Person of the principal component of Indebtedness of other Persons to the extent Guaranteed by such Person; and
- (9) to the extent not otherwise included in this definition, net obligations of such Person under Currency Agreements, Commodity Hedging Agreements and Interest Rate Agreements (the amount of any such obligations to be equal at any time to the termination value of such agreement or arrangement giving rise to such obligation that would be payable by such Person at such time).

The term “Indebtedness” shall not include (i) Subordinated Shareholder Funding, (ii) any lease (including for avoidance of doubt, any network lease or any Operating IRU), concession or license of property (or Guarantee thereof) which would be considered an operating lease under IFRS as in effect on December 12, 2012 or the Issue Date, (iii) prepayments of deposits received from clients or customers in the ordinary course of business, (iv) any pension obligations, (v) Contingent Obligations, (vi) obligations under or in respect of Qualified Receivables Financing, (vii) obligations under any license, permit or other approval (or Guarantees given in respect of such obligations) Incurred prior to the Issue Date or in the ordinary course of business, (viii) non-interest bearing installment obligations and accrued liabilities Incurred in the ordinary course of business that are not more than 120 days past due, (ix) Indebtedness in respect of the Incurrence by Altice International or any Restricted Subsidiary of Indebtedness in respect of standby letters of credit, performance bonds or surety bonds provided by Altice International or any Restricted Subsidiary in the ordinary course of business to the extent such letters of credit or bonds are not drawn upon or, if and to the extent drawn upon are honored in accordance with their terms and if, to be reimbursed, are reimbursed no later than the fifth Business Day following receipt by such Person of a demand for reimbursement following payment on the letter of credit or bond, and (x) Indebtedness Incurred by Altice International or a Restricted Subsidiary in connection with a transaction where (A) such Indebtedness is borrowed from a bank or trust company, having a combined capital and surplus and undivided profits of not less than €250 million, whose debt has a rating immediately prior to the time such transaction is entered into, of at least A or the equivalent thereof by S&P and A2 or the equivalent thereof by Moody’s and (B) a substantially concurrent Investment is made by Altice International or a Restricted Subsidiary in the form of cash deposited with the lender of such Indebtedness, or a Subsidiary or Affiliate thereof, in amount equal to such Indebtedness. For the avoidance of doubt and notwithstanding the above, the term “Indebtedness” excludes any accrued expenses and trade payables, any obligations under guarantees issued in connection with various operating and telecommunications licenses, any obligations under the guarantee by HOT issued to the Ministry of Communications and Broadcast Council in connection with various operating and broadcasting licenses, including the bank guarantee in connection with the HOT Mobile’s winning a frequency allotment and receiving a cellular license, and any obligations of HOT Systems towards the State of

Israel under an agreement dated July 10, 2001, between HOT Systems and other cable companies and between the State of Israel, in each case, as in effect on December 12, 2012.

The amount of Indebtedness of any Person at any time in the case of a revolving credit or similar facility shall be the total amounts of funds borrowed and then outstanding. The amount of Indebtedness of any Person at any date shall be determined as set forth above or otherwise provided in the Indenture, and (other than with respect to letters of credit or Guarantees or Indebtedness specified in clause (7), (8) or (9) above) shall equal the amount thereof that would appear on a balance sheet of such Person (excluding any notes thereto) prepared on the basis of IFRS.

Notwithstanding the above provisions, in no event shall the following constitute Indebtedness:

- (i) in connection with the purchase by Altice International or any Restricted Subsidiary of any business, any post-closing payment adjustments to which the seller may become entitled to the extent such payment is determined by a final closing balance sheet or such payment depends on the performance of such business after the closing; *provided, however*, that, at the time of closing, the amount of any such payment is not determinable and, to the extent such payment thereafter becomes fixed and determined, the amount is paid within 30 days thereafter;
- (ii) for the avoidance of doubt, any obligations in respect of workers' compensation claims, early retirement or termination obligations, pension fund obligations or contributions or similar claims, obligations or contributions or social security or wage Taxes;
- (iii) parallel debt obligations, to the extent such obligations mirror other Indebtedness; or
- (iv) Capitalized Lease Obligations.

“*Independent Financial Advisor*” means an investment banking or accounting firm of international standing or any third party appraiser of international standing; *provided, however*, that such firm or appraiser is not an Affiliate of the Issuer.

“*Initial Public Offering*” means the Equity Offering of common stock or other common equity interests of Altice S.A., which was completed on February 5, 2014, as a result of which, the shares of common stock or other common equity interests of Altice S.A. in such offering are listed on the Euronext Amsterdam.

“*Intercreditor Agreement*” means the intercreditor agreement dated December 12, 2012 and made between (among others) the Issuer, HoldCo, the Guarantors, the Security Agent, the Facility Agent, the Mandated Lead Arrangers (as defined therein), certain financial institutions party thereto, the Hedging Banks (as defined therein) and the trustee for the Existing Senior Secured Notes, as amended, which the Trustee is expected to accede to on the Completion Date.

“*Interest Rate Agreement*” means, with respect to any Person, any interest rate protection agreement, interest rate future agreement, interest rate option agreement, interest rate swap agreement, interest rate cap agreement, interest rate collar agreement, interest rate hedge agreement or other similar agreement or arrangement to which such Person is party or a beneficiary.

“*Investment*” means, with respect to any Person, all investments by such Person in other Persons (including Affiliates) in the form of any direct or indirect advance, loan or other extensions of credit (other than advances or extensions of credit to customers, suppliers, directors, officers or employees of any Person in the ordinary course of business, and excluding any debt or extension of credit represented by a bank deposit other than a time deposit) or capital contribution to (by means of any transfer of cash or other property to others or any payment for property or services for the account or use of others), or the Incurrence of a Guarantee of any obligation of, or any purchase or acquisition of Capital Stock, Indebtedness or other similar instruments issued by, such other Persons and all other items that are or would be classified as investments on a balance sheet (excluding any notes thereto) prepared on the basis of IFRS; *provided, however*, that endorsements of negotiable instruments and documents in the ordinary course of business will not be deemed to be an Investment. If Altice International or any Restricted Subsidiary issues, sells or otherwise disposes of any Capital Stock of a Person that is a Restricted Subsidiary such that, after giving effect thereto, such Person is no longer a Restricted Subsidiary, any Investment by Altice International or any Restricted Subsidiary in such Person remaining after giving effect thereto will be deemed to be a new Investment equal to the fair market value of the Capital Stock of such Subsidiary not sold or disposed of in an amount determined as provided in the final paragraph of the covenant described above under the caption “—*Certain Covenants—Limitation on Restricted Payments*”.

For purposes of “—*Certain Covenants—Limitation on Restricted Payments*”:

- (1) “Investment” will include the portion (proportionate to Altice International’s equity interest in a Restricted Subsidiary to be designated as an Unrestricted Subsidiary) of the fair market value of the net assets of such

Restricted Subsidiary at the time that such Restricted Subsidiary is designated an Unrestricted Subsidiary; *provided, however*, that upon a redesignation of such Subsidiary as a Restricted Subsidiary, Altice International will be deemed to continue to have a permanent “Investment” in an Unrestricted Subsidiary in an amount (if positive) equal to (a) Altice International’s “Investment” in such Subsidiary at the time of such redesignation less (b) the portion (proportionate to Altice International’s equity interest in such Subsidiary) of the fair market value of the net assets (as conclusively determined by an Officer or the Board of Directors of Altice International in good faith) of such Subsidiary at the time that such Subsidiary is so re-designated a Restricted Subsidiary; and

- (2) any property transferred to or from an Unrestricted Subsidiary will be valued at its fair market value at the time of such transfer (or if earlier at the time of entering into an agreement to sell such property), in each case as determined in good faith by an Officer or the Board of Directors of Altice International.

The amount of any Investment outstanding at any time shall be the original cost of such Investment, reduced (at the Issuer’s option) by any dividend, distribution, interest payment, return of capital, repayment or other amount or value received in respect of such Investment.

“*Investment Grade Securities*” means:

- (1) securities issued or directly and fully Guaranteed or insured by the United States or Canadian government or any agency or instrumentality thereof (other than Cash Equivalents);
- (2) securities issued or directly and fully guaranteed or insured by a member state of the European Union, Switzerland, Norway or any agency or instrumentality thereof (other than Cash Equivalents);
- (3) debt securities or debt instruments with a rating of “A” or higher from S&P or “A3” or higher by Moody’s or the equivalent of such rating by such rating organization or, if no rating of Moody’s or S&P then exists, the equivalent of such rating by any other Nationally Recognized Statistical Ratings Organization, but excluding any debt securities or instruments constituting loans or advances among Altice International and its Subsidiaries; and
- (4) investments in any fund that invests exclusively in investments of the type described in clauses (1), (2) and (3) above which fund may also hold cash and Cash Equivalents pending investment or distribution.

“*Investment Grade Status*” shall occur when the Notes receive both of the following:

- (1) a rating of “BBB–” or higher from S&P; and
- (2) a rating of “Baa3” or higher from Moody’s,

or the equivalent of such rating by either such rating organization or, if no rating of Moody’s or S&P then exists, the equivalent of such rating by any other Nationally Recognized Statistical Ratings Organization.

“*Investor*” means the ultimate controlling shareholder of Altice S.A. on the Issue Date.

“*Investor Affiliate*” means (i) the Investor or any of his immediate family members, and any such persons’ respective Affiliates and direct and indirect Subsidiaries, (ii) any sponsor, limited partnerships or entities managed or controlled by the Investor or any of his immediate family, or any of such persons’ respective Affiliates and direct or indirect Subsidiaries, (iii) any trust of the Investor or any of his immediate family, or any of such persons’ respective Affiliates and direct or indirect Subsidiaries or any trust in respect of which any such persons is a trustee, (iv) any partnership of which the Investor or any of his immediate family, or any of such persons’ respective Affiliates or direct or indirect Subsidiaries is a partner that is managed or controlled by the Investor, any of his immediate family or any of such persons’ respective Affiliates or direct or indirect Subsidiaries, and (v) any trust, fund or other entity which is managed by, or is under the control of, the Investor or any of his immediate family, or any of such persons’ respective Affiliates or direct or indirect Subsidiaries, but excluding Altice International or any of its Subsidiaries.

“*IPO Market Capitalization*” means an amount equal to (i) the total number of issued and outstanding shares of common stock or common equity interests of Altice S.A. at the time of closing of the Initial Public Offering multiplied by (ii) the price per share at which such shares of common stock or common equity interests are sold in such Initial Public Offering.

“*Issue Date*” means February 4, 2015.

“*Issuer*” means Altice Financing S.A., a Luxembourg public limited liability company (*société anonyme*).

“*Issuer Asset Sale*” means the sale, lease, conveyance or other disposition of any rights, property or assets by the Issuer. Notwithstanding the preceding, none of the following items will be deemed to be an Issuer Asset Sale:

- (1) the granting of a Permitted Issuer Lien;
- (2) any Permitted Issuer Investment; and
- (3) the sale or other disposition of cash, Cash Equivalents, Temporary Cash Investments, or Investment Grade Securities.

“*Issuer Proceeds Loan*” means any loan agreement (including in the form of a note) entered into between the Issuer and any Guarantor pursuant to which Issuer lends to such Guarantor all or a portion of the net proceeds of any Incurrence of Indebtedness by the Issuer; *provided* that a Lien over such Issuer Proceeds Loan is granted at the time of its Incurrence on a senior basis to secure the Notes and the Guarantees.

“*July 2013 Senior Notes*” refers to the €250 million aggregate principal amount of HoldCo’s 9% Senior Notes due 2023 issued on June 19, 2013 and released from escrow on July 2, 2013.

“*July 2013 Senior Notes Indenture*” means the indenture dated as of June 19, 2013, as amended, among, *inter alios*, HoldCo, as issuer, the guarantors party thereto and the trustee and security agent party thereto, governing the July 2013 Senior Notes.

“*July 2013 Transactions*” means the transactions described under “The Transactions” in the offering memorandum dated June 19, 2013 relating to the July 2013 Senior Notes.

“*Knewon*” means Knewon, S.A., a public limited liability company (*sociedade anónima*) incorporated under the laws of Portugal.

“*Lien*” means any mortgage, pledge, security interest, encumbrance, lien or charge of any kind (including any conditional sale or other title retention agreement or lease in the nature thereof).

“*Management Advances*” means loans or advances made to, or Guarantees with respect to loans or advances made to, directors, officers, employees or consultants of any Parent, Altice International or any Restricted Subsidiary:

- (1) (a) in respect of travel, entertainment or moving related expenses Incurred in the ordinary course of business or (b) for purposes of funding any such Person’s purchase of Capital Stock or Subordinated Shareholder Funding (or similar obligations) of Altice International, its Restricted Subsidiaries or any Parent (i) not to exceed an amount (net of repayments of any such loans or advances) equal to €10 million in any calendar year (with unused amounts in any calendar year being carried over to the succeeding calendar years; *provided* that the aggregate Management Advances made under this sub-clause (b)(i) do not exceed €20 million in any fiscal year) or (ii) with the approval of the Board of Directors of Altice S.A.;
- (2) in respect of moving related expenses Incurred in connection with any closing or consolidation of any facility or office; or
- (3) (in the case of this clause (3)) not exceeding €7.5 million in the aggregate outstanding at any time.

“*Management Investors*” means the current or former officers, directors, employees and other members of the management of or consultants to any Parent, Altice International or any of their respective Subsidiaries (including, without limitation, the Target), or spouses, family members or relatives thereof, or any trust, partnership or other entity for the benefit of or the beneficial owner of which (directly or indirectly) is any of the foregoing, or any of their heirs, executors, successors and legal representatives, who at any date beneficially own or have the right to acquire, directly or indirectly, Capital Stock of Altice International, any Restricted Subsidiary or any Parent.

“*Market Capitalization*” means an amount equal to (i) the total number of issued and outstanding shares of common stock or common equity interests of Altice S.A. on the date of the declaration of the relevant dividend multiplied by (ii) the arithmetic mean of the closing prices per share of such common stock or common equity interests for the 30 consecutive trading days immediately preceding the date of declaration of such dividend.

“*Meo, S.A.*” refers to the former MEO—Serviços de Comunicações e Multimédia, S.A., a public limited liability company (*sociedade anónima*) incorporated under the laws of Portugal with registration number 502 600 268, which was merged into the former PT Comunicações, S.A. on December 29, 2014.

“*Minority Shareholder*” means each of Yedioth Communications Ltd., Fishman Family Properties Ltd., Fishman Family Properties Management (1988) Ltd. and Monitin Itonut Holdings (1985) Ltd.

“*Minority Shareholder Call Option*” means the right to purchase shares of Capital Stock of HOT pursuant to the applicable Minority Shareholder Purchase Agreement.

“*Minority Shareholder Option Exercise*” means the exercise by a Minority Shareholder of the Minority Shareholder Call Option on the terms provided in the applicable Minority Shareholder Purchase Agreement.

“*Minority Shareholder Purchase Agreements*” means each of (a) the Agreement, dated as of November 5, 2012 entered into by and between Yedioth Communications Ltd., a company incorporated in Israel with a registered address of 2 Mozes Street, Tel Aviv, Israel and the Company and (b) the Agreement dated as of November 5, 2012 entered into by and among Fishman Family Properties Ltd. and Fishman Family Properties Management (1988) Ltd., each a company incorporated in Israel with a registered address of 20 Lincoln Street, Tel Aviv, Israel, and Monitin Itonut Holdings (1985) Ltd., a company incorporated in Israel with a registered address of 53 Etzel Street, Rishon Lezion 75706, Israel and the Company, in each case providing for waiver of certain consent rights relating to the December 2012 Transactions and granting of the Minority Shareholder Call Option as consideration therefor, in each case as in effect on December 12, 2012, except for amendments that are not materially adverse to the interests of the Holders of the Notes.

“*Moody’s*” means Moody’s Investors Service, Inc. or any of its successors or assigns that is a Nationally Recognized Statistical Rating Organization.

“*Nationally Recognized Statistical Rating Organization*” shall have the same meaning as used in Section 3(a)(62) of the Exchange Act.

“*Net Available Cash*” from an Asset Disposition means cash payments received (including any cash payments received by way of deferred payment of principal pursuant to a note or installment receivable or otherwise and net proceeds from the sale or other disposition of any securities received as consideration, but only as and when received, but excluding any other consideration received in the form of assumption by the acquiring person of Indebtedness or other obligations relating to the properties or assets that are the subject of such Asset Disposition or received in any other non-cash form) therefrom, in each case net of:

- (1) all legal, accounting, investment banking, title and recording tax expenses, commissions and other fees and expenses Incurred, and all Taxes paid or required to be paid or accrued as a liability under IFRS (after taking into account any available tax credits or deductions and any Tax Sharing Agreements), as a consequence of such Asset Disposition;
- (2) all payments made on any Indebtedness which is secured by any assets subject to such Asset Disposition, in accordance with the terms of any Lien upon such assets, or which must by its terms, or in order to obtain a necessary consent to such Asset Disposition, or by applicable law, be repaid out of the proceeds from such Asset Disposition;
- (3) all distributions and other payments required to be made to minority interest holders (other than any Parent, Altice International or any of their respective Subsidiaries) in Subsidiaries or joint ventures as a result of such Asset Disposition; and
- (4) the deduction of appropriate amounts required to be provided by the seller as a reserve, on the basis of IFRS, against (a) any liabilities associated with the assets disposed in such Asset Disposition and retained by Altice International or any Restricted Subsidiary after such Asset Disposition; or (b) any purchase price adjustment or earn-out in connection with such Asset Disposition.

“*Net Cash Proceeds*”, means, with respect to any issuance or sale of Capital Stock or Subordinated Shareholder Funding, any Incurrence of any Indebtedness or any sale of any asset, the cash proceeds of such issuance or sale net of attorneys’ fees, accountants’ fees, underwriters’ or placement agents’ fees, listing fees, discounts or commissions and brokerage, consultant and other fees and charges actually Incurred in connection with such issuance or sale and net of taxes paid or payable as a result of such issuance or sale (after taking into account any available tax credit or deductions and any tax sharing arrangements).

“*New ASA Notes*” refers to the \$1,480 million aggregate principal amount of Altice S.A.’s 7.625% Senior Notes due 2025 and €750 million aggregate principal amount of Altice S.A.’s 6.250% Senior Notes due 2025, in each case, issued on the Issue Date.

“*New Pari Passu Revolving Credit Facility*” means the €501 million revolving credit facility agreement, dated on or about December 9, 2014, as amended, restated, supplemented or otherwise modified from time to time, among the Issuer, as borrower, the lenders from time to time party thereto, Citibank International Plc as facility agent and Citibank, N.A., London Branch, as security agent.

“*New Senior Credit Facility*” means the term loan credit agreement dated on or around the Issue Date between the Issuer as borrower and the persons listed in Schedule 2.01 thereto as lenders, Deutsche Bank AG, London Branch, as the Administrative Agent and Citibank, N.A., London Branch as Security Agent, as amended.

“*New Senior Notes Indenture*” means the indenture dated as of the Issue Date, as amended, among, inter alios, HoldCo, as issuer, the guarantors party thereto and the trustee and security agent party thereto, governing the New Senior Notes.

“*New Super Senior Revolving Credit Facility*” means the €330 million revolving credit facility agreement, dated on or about the Issue Date as amended, restated, supplemented or otherwise modified from time to time, among the Issuer, as borrower, the lenders from time to time party thereto, Citibank International plc as facility agent and Citibank, N.A., London Branch, as security agent.

“*New Term Loans*” means the term loans extended to the Issuer pursuant to the New Senior Credit Facility.

“*NIS*” means New Israeli Shekels, the lawful currency of the State of Israel.

“*Note Guarantee*” means the Guarantee by each Guarantor of the Issuer’s obligations under the Indenture and the Notes, executed pursuant to the provisions of the Indenture.

“*Notes Documents*” means the Notes (including Additional Notes), the Indenture, the Security Documents, the Notes Escrow Agreement, the Intercreditor Agreement, any Additional Intercreditor Agreements, the Issuer Proceeds Loans, the Hot Security Documents, the OMT Proceeds Loans and the OMT Security Documents.

“*Notes Escrow Agreement*” means the escrow agreement dated as of the Issue Date among, inter alios, the Issuer, the Trustee and the Escrow Agent.

“*ODO*” means Altice Hispaniola S.A. (formerly known as Orange Dominicana S.A.), a limited liability corporation (*sociedad anónima*) incorporated under the laws of the Dominican Republic.

“*ONI Group*” refers to Winreason, ONI S.G.P.S., Onitelecom, Knewon, and/or their subsidiaries as the context requires.

“*ONI Security*” refers to the security interests governed by Portuguese law created by Winreason, ONI, S.G.P.S. and its subsidiaries under the ONI Security Agreement and as amended from time to time.

“*ONI Security Agreement*” refers to the security agreement dated 10 November 10, 2011 among, inter alios, Winreason, ONI S.G.P.S., Onitelecom, Hubgrade, S.A., F300—Fiber Communications, S.A. and Knewon, S.A., as pledgors, and Banco Efisa, S.A., as security agent (as amended and restated on August 8, 2013).

“*ONI S.G.P.S.*” means ONI S.G.P.S., S.A., a holding company (*sociedade gestora de participações*) incorporated under the laws of Portugal.

“*Onitelecom*” means Onitelecom—Infocomunicações, S.A., a public limited liability company (*sociedade anónima*) incorporated under the laws of Portugal.

“*Onitelecom Proceeds Notes*” refers to the outstanding bonds issued by ONI and subscribed for by Altice Holdings.

“*Offering Memorandum*” means the offering memorandum in relation to the Notes to be issued on the Issue Date.

“*Officer*” means, with respect to any Person, (1) any member of the Board of Directors, the Chief Executive Officer, the President, the Chief Operating Officer, the Chief Financial Officer, any Vice President, the Treasurer or the Secretary (a) of such Person or (b) if such Person is owned or managed by a single entity, of such entity, or (2) any other individual designated as an “Officer” for the purposes of the Indenture by the Board of Directors of such Person.

“*Officer’s Certificate*” means, with respect to any Person, a certificate signed by one Officer of such Person.

“*OMT Direct Obligation Event*” means the election by Altice International to cause NewCo OMT and its Restricted Subsidiaries to become direct Guarantors of the Notes by causing each of them to provide a Guarantee of the Notes on a senior basis and grant an equivalent Lien securing the Notes over all of its assets that constitute OMT Proceeds Loans Collateral on such date; *provided* that where a Guarantee by a Restricted Subsidiary of NewCo OMT could reasonably be expected to give rise to or result in: (1) any violation of applicable law or regulation; (2) any liability for the officers, directors or (except in the case of a Restricted Subsidiary that is a partnership) shareholders of such Restricted Subsidiary (or, in the case of a Restricted Subsidiary that is a partnership, directors or shareholders of the partners of such partnership); (3) any cost, expense, liability or obligation (including with respect to any Taxes) other than reasonable out-of-pocket expenses and other than reasonable expenses incurred in connection with any governmental or regulatory filings required as a result of, or any measures pursuant to clause (1) hereof undertaken in connection with, such Guarantee, which in any case under any of clauses (1), (2) and (3) of this paragraph cannot be avoided through measures reasonably available to Altice International, NewCo OMT or such Restricted Subsidiary; or (4) such Restricted Subsidiary is prohibited from incurring such Guarantee by the terms of any Indebtedness of such Restricted Subsidiary that is not prepayable without a prepayment premium (in each case, other than Indebtedness Incurred to provide all or any portion of the funds utilized to consummate the transaction or series of related transactions pursuant to which such Person became a Restricted Subsidiary) (*provided* that this clause (4) applies only for so long as such prepayment premium applies to such Indebtedness), such Restricted Subsidiary shall be excluded from the requirement to provide such Guarantee and grant a Lien over its assets as a condition to the consummation of the OMT Direct Obligation Event.

“*OMT Proceeds Loans*” means collectively, the direct and indirect proceeds loans made by Altice Holdings to NewCo OMT and its Subsidiaries in connection with the acquisition of OMT Invest by Altice International and Altice Caribbean.

“*OMT Proceeds Loans Collateral*” means the rights, property and assets securing the OMT Proceeds Loans and any rights, property or assets over which a Lien has been granted to secure the Obligations of NewCo OMT under the applicable OMT Proceeds Loan.

“*OMT Proceeds Loan Guarantees*” means the guarantee by each OMT Proceeds Loan Guarantor of NewCo OMT’s obligations under the OMT Proceeds Loans, executed pursuant to the provisions thereof and the Existing Senior Secured Notes Indenture.

“*OMT Proceeds Loans Security Documents*” means the security agreements, pledge agreements, collateral assignments, and any other instrument and document executed and delivered pursuant to the OMT Proceeds Loans or otherwise or any of the foregoing, as the same may be amended, supplemented or otherwise modified from time to time, creating the security interests in the OMT Proceeds Loans Collateral as contemplated by the Indenture and the OMT Proceeds Loan.

“*Operating IRU*” means an indefeasible right of use of, or operating lease or payable for lit or unlit fiber optic cable or telecommunications conduit or the use of either.

“*Opinion of Counsel*” means a written opinion from legal counsel reasonably satisfactory to the Trustee, which opinion may contain customary assumptions and qualifications. The counsel may be an employee of or counsel to any Parent, the Issuer, Altice International or any of their Subsidiaries.

“*Parent*” means any Person of which Altice International at any time is or becomes a Subsidiary and any holding companies established by any Permitted Holder for purposes of holding its investment in any Parent.

“*Parent Expenses*” means:

- (1) costs (including all professional fees and expenses) Incurred by any Parent in connection with reporting obligations under or otherwise Incurred in connection with compliance with applicable laws, rules or regulations of any governmental, regulatory or self-regulatory body or stock exchange, the Indenture or any other agreement or instrument relating to Indebtedness of a Parent, Altice International or any Restricted Subsidiary, including in respect of any reports filed with respect to the Securities Act, Exchange Act or the respective rules and regulations promulgated thereunder;
- (2) customary indemnification obligations of any Parent owing to directors, officers, employees or other Persons under its charter or by-laws or pursuant to written agreements with any such Person to the extent relating to a Parent, Altice International or their respective Subsidiaries;
- (3) obligations of any Parent in respect of director and officer insurance (including premiums therefor) to the extent relating to a Parent, Altice International or their respective Subsidiaries and reasonable fees and reimbursement of expenses to, and customary indemnities and employee benefit and pension expenses provided on behalf of,

directors, officers, consultants or employees of Altice International, any Restricted Subsidiary or any Parent (whether directly or indirectly and including through any Person owned or controlled by any of such directors, officers or employees)

- (4) fees and expenses payable by any Parent in connection with the December 2012 Transactions, July 2013 Transactions, December 2013 Transactions and the Transactions;
- (5) general corporate overhead expenses, including (a) professional fees and expenses and other operational expenses of any Parent related to the ownership or operation of the business of Altice International or any of the Restricted Subsidiaries including acquisitions or dispositions by Altice International or a Subsidiary permitted hereunder (whether or not successful), in each case, to the extent such costs, obligations and/or expenses are not paid by another Subsidiary of such or (b) costs and expenses with respect to any litigation or other dispute relating to the December 2012 Transactions, July 2013 Transactions, December 2013 Transactions, and the Transactions, or the ownership, directly or indirectly, by any Parent;
- (6) any fees and expenses required to maintain any Parent's corporate existence and to provide for other ordinary course operating costs, including customary salary, bonus and other benefits payable to officers and employees of such Parent;
- (7) to reimburse out-of-pocket expenses of the Board of Directors of any Parent and payment of all reasonable out-of-pocket expenses Incurred by any Permitted Holder in connection with its direct or indirect investment in Altice International and its Subsidiaries;
- (8) other fees, expenses and costs relating directly or indirectly to activities of Altice International and its Subsidiaries or any Parent or any other Person established for purposes of or in connection with the Transactions or which holds directly or indirectly any Capital Stock or Subordinated Shareholder Funding of Altice International, in an amount not to exceed €5 million in any fiscal year;
- (9) any Public Offering Expenses; and
- (10) payments pursuant to any Tax Sharing Agreement in the ordinary course of business or as a result of the formation and maintenance of any consolidated group for tax or accounting purposes in the ordinary course of business.

“*Pari Passu Indebtedness*” means (1) with respect to the Issuer, any Indebtedness that ranks *pari passu* in right of payment to the Notes; and (2) with respect to the Guarantors, any Indebtedness that ranks *pari passu* in right of payment to such Guarantor's Guarantee of the Notes.

“*Paying Agent*” means any Person authorized by the Issuer to pay the principal of (and premium, if any) or interest on any Note on behalf of the Issuer. “*Permitted Asset Swap*” means the concurrent purchase and sale or exchange of assets used or useful in a Similar Business or a combination of such assets and cash, Cash Equivalents or Temporary Cash Investments between Altice International or any of the Restricted Subsidiaries and another Person; *provided* that any cash or Cash Equivalents received in excess of the value of any cash or Cash Equivalents sold or exchanged must be applied in accordance with the covenant described under “—*Certain Covenants—Limitation on Sales of Assets and Subsidiary Stock*”.

“*Payment Block Event*” means: (1) any Event of Default described in clause (1) or (2) of the first paragraph under the heading “—*Events of Default*” has occurred and is continuing; (2) any Event of Default described in clause (6) or (11) of the first paragraph under the heading “—*Events of Default*” has occurred and is continuing; and (3) any other Event of Default has occurred and is continuing and the Trustee or the Holders of at least 25% in aggregate principal amount of the then outstanding Notes have declared all the Notes to be due and payable immediately (and such acceleration has not been rescinded). No Payment Block Event shall be deemed to have occurred unless the Trustee has delivered notice of the occurrence of such Payment Block Event to the Issuer.

“*Permitted Collateral Liens*” means:

- (1) Liens on the Notes Collateral that are described in one or more of clauses (2), (3), (4), (5), (6), (8), (9), (11), (12), (13), (18), (20), (23), (24) and (28) of the definition of “Permitted Liens”;
- (2) Liens on the Notes Collateral (other than any Notes Collateral subject to the Escrow Assignment) to secure (a) Indebtedness that is permitted to be Incurred under the first paragraph of the covenant described under “—*Certain Covenants—Limitation on Indebtedness*”, (b) Indebtedness that is permitted to be Incurred under clauses (1) (which may be Super Priority Indebtedness), (2)(a) (in the case of (2)(a), to the extent such

Guarantee is in respect of Indebtedness otherwise permitted to be secured on the Notes Collateral and specified in this definition of Permitted Collateral Liens), (4)(a), (5)(ii), (7)(a) (to the extent relating to Currency Agreements or Interest Rate Agreements related to Indebtedness (including Indebtedness of HoldCo to the extent such Indebtedness is Guaranteed by the Issuer and the Guarantors pursuant to clause (15) of the second paragraph of the covenant described under “—*Certain Covenants—Limitation on Indebtedness*”) and which, in each case, may be Super Priority Indebtedness), (7)(b) (which may be Super Priority Indebtedness), (14) (so long as, in the case of clause (14), on the date of Incurrence of Indebtedness pursuant to such clause (14) and after giving effect thereto on a *pro forma* basis (including a *pro forma* application of the net proceeds therefrom) as if such Indebtedness had been Incurred at the beginning of the relevant period, the Consolidated Net Senior Secured Leverage Ratio is no greater than 3.0 to 1.0) and clause (16) under the second paragraph of the covenant described under “—*Certain Covenants—Limitation on Indebtedness*” and (c) any Refinancing Indebtedness in respect of Indebtedness referred to in the foregoing clause (a) or (b), *provided, however*, that (i) such Lien shall rank *pari passu* or junior to the Liens securing the Notes and the Note Guarantees (including by virtue of the Intercreditor Agreement or an Additional Intercreditor Agreement); (ii) in each case, all property and assets (including, without limitation, the Notes Collateral) securing such Indebtedness also secure the Notes or the Note Guarantees on a senior or *pari passu* basis (including by virtue of the Intercreditor Agreement or an Additional Intercreditor Agreement but no such Indebtedness (other than Super Priority Indebtedness) shall have priority to the Notes over amounts received from the sale of the Notes Collateral pursuant to an enforcement sale or other distressed disposal of such Notes Collateral); and (iii) each of the parties thereto will have entered into the Intercreditor Agreement or an Additional Intercreditor Agreement; and

- (3) Liens on the Capital Stock of the Issuer, Cool and Altice Holdings and Liens on the HoldCo Proceeds Loans and Liens on the Subordinated Shareholder Loan, in each case, that secures Indebtedness of HoldCo (and Guarantees thereof) that is Guaranteed by the Issuer and the Guarantors pursuant to clause (4)(c), (5)(ii) and clause (15) of the second paragraph of the covenant described under “—*Certain Covenants—Limitation on Indebtedness*”; *provided* that, in the case of this clause (3), (x) such Liens shall rank junior to the Liens securing the Notes and the Note Guarantees and (y) the holders of such Indebtedness (or their representative) accede to the Intercreditor Agreement or an Additional Intercreditor Agreement.

“*Permitted Holders*” means, collectively, (1) the Investor, (2) Investor Affiliates and (3) any Person who is acting as an underwriter in connection with a public or private offering of Capital Stock of any Parent or Altice International, acting in such capacity. Any person or group whose acquisition of beneficial ownership constitutes a Change of Control in respect of which a Change of Control Offer is made in accordance with the requirements of the Indenture will thereafter, together with its Affiliates, constitute an additional Permitted Holder.

“*Permitted HOT Proceeds Note Collateral Liens*” means:

- (1) Liens on HOT Proceeds Note Collateral that are described in one or more of clauses (2), (3), (4), (5), (6), (8), (9), (11), (12), (13), (18), (20), (23), (24) and (28) of the definition of “Permitted Liens”; and
- (2) Liens on the HOT Proceeds Note Collateral to secure (a) Indebtedness that is permitted to be Incurred under clauses (1) (which may be Super Priority Indebtedness), (2)(a) (in the case of (2)(a), to the extent such Guarantee is in respect of Indebtedness otherwise permitted to be secured and specified in this clause (2) of this definition of Permitted HOT Proceeds Note Collateral Liens) and clause (16) under the second paragraph of the covenant described under “—*Certain Covenants—Limitation on Indebtedness*”), (b) any Refinancing Indebtedness in respect of Indebtedness referred to in this clause (2) and (c) any Issuer Proceeds Loans Incurred in accordance with the fifth paragraph under the heading “—*Certain Covenants—Limitation on Indebtedness*” under which HOT is the borrower or issuer (and the HOT Proceeds Note Guarantees in respect thereof), *provided, however*, that (i) such Lien shall rank *pari passu* or junior to the Liens securing the HOT Proceeds Note; (ii) in each case, all property and assets (including, without limitation, the HOT Proceeds Note Collateral) securing such Indebtedness also secure the HOT Proceeds Note or the Guarantees of the HOT Proceeds Note on a senior or *pari passu* basis; and (iii) each of the parties thereto and the Issuer as lender under the HOT Proceeds Note will have entered into an intercreditor agreement containing terms not materially less favorable to such lender than the terms of the Intercreditor Agreement with respect to the Holders of the Notes.

“*Permitted Investment*” means (in each case, by Altice International or any of the Restricted Subsidiaries and subject to the covenant described under the heading “—*Certain Covenants—Limitation on Issuer Activities*”):

- (1) Investments in (a) a Restricted Subsidiary (including the Capital Stock of a Restricted Subsidiary) or Altice International (other than any Investment in a Minority Shareholder Call Option or Minority Shareholder Purchase Agreement) or (b) any Person (including the Capital Stock of any such Person) that is engaged in any Similar Business and such Person will, upon the making of such Investment, become a Restricted Subsidiary;

- (2) Investments in another Person if such Person is engaged in any Similar Business and as a result of such Investment such other Person is merged, consolidated or otherwise combined with or into, or transfers or conveys all or substantially all its assets to, Altice International or a Restricted Subsidiary;
- (3) Investments in cash, Cash Equivalents, Temporary Cash Investments or Investment Grade Securities;
- (4) Investments in receivables owing to Altice International or any Restricted Subsidiary created or acquired in the ordinary course of business and payable or dischargeable in accordance with customary trade terms; *provided, however*, that such trade terms may include such concessionary trade terms as Altice International or any such Restricted Subsidiary deems reasonable under the circumstances;
- (5) Investments in payroll, travel and similar advances to cover matters that are expected at the time of such advances ultimately to be treated as expenses for accounting purposes and that are made in the ordinary course of business;
- (6) Management Advances;
- (7) Investments in Capital Stock, obligations or securities received in settlement of debts created in the ordinary course of business and owing to Altice International or any Restricted Subsidiary (including obligations of trade creditors and customers), or as a result of foreclosure, perfection or enforcement of any Lien, or in satisfaction of judgments or pursuant to any plan of reorganization or similar arrangement including upon the bankruptcy or insolvency of a debtor or in compromise or resolution of any litigation, arbitration or other dispute;
- (8) Investments made as a result of the receipt of non-cash consideration from a sale or other disposition of property or assets, including an Asset Disposition, in each case, that was made in compliance with “—*Certain Covenants—Limitation on Sales of Assets and Subsidiary Stock*” and other Investments resulting from the disposition of assets in transactions excluded from the definition of “Asset Disposition” pursuant to the exclusions from such definition;
- (9) Investments in existence on, or made pursuant to legally binding commitments in existence on, the Issue Date and any modification, replacement, renewal or extension thereof; *provided* that the amount of any such Investment may not be increased except (a) as required by the terms of such Investment as in existing on the Issue Date or (b) as otherwise permitted by the Indenture;
- (10) Currency Agreements, Interest Rate Agreements, Commodity Hedging Agreements and related Hedging Obligations, which transactions or obligations are Incurred pursuant to clause (7) of the second paragraph of the covenant described under “—*Certain Covenants—Limitation on Indebtedness*”;
- (11) pledges or deposits with respect to leases or utilities provided to third parties in the ordinary course of business or Liens otherwise described in the definition of “Permitted Liens” or made in connection with Liens permitted under the covenant described under “—*Certain Covenants—Limitation on Liens*”;
- (12) any Investment to the extent made using Capital Stock of Altice International (other than Disqualified Stock or Designated Preference Shares), Subordinated Shareholder Funding or Capital Stock of any Parent as consideration;
- (13) any transaction to the extent constituting an Investment that is permitted and made in accordance with the provisions of the second paragraph of the covenant described under “—*Certain Covenants—Limitation on Affiliate Transactions*” (except those described in clauses (1), (3), (6), (8), (9) and (12) of that paragraph);
- (14) Guarantees not prohibited by the covenant described under “—*Certain Covenants—Limitation on Indebtedness*” and (other than with respect to Indebtedness) guarantees, keepwells and similar arrangements in the ordinary course of business;
- (15) Investments in the Notes, any Additional Notes, the Existing Senior Secured Notes, and the Term Loans or any Pari Passu Indebtedness of the Issuer;
- (16) (a) Investments acquired after the Issue Date as a result of the acquisition by Altice International or any Restricted Subsidiary of another Person, including by way of a merger, amalgamation or consolidation with or into Altice International or any of its Restricted Subsidiaries in a transaction that is not prohibited by the covenant described under “—*Certain Covenants—Merger and Consolidation*” to the extent that such Investments were not made in contemplation of such acquisition, merger, amalgamation or consolidation and

(b) Investments of a Restricted Subsidiary existing on the date such Person becomes a Restricted Subsidiary to the extent that such Investments were not made in contemplation of such Person becoming a Restricted Subsidiary;

- (17) Investments, taken together with all other Investments made pursuant to this clause (17) and at any time outstanding, in an aggregate amount at the time of such Investment not to exceed the greater of 3.0% of Total Assets and €375 million plus the amount of any distributions, dividends, payments or other returns in respect of such Investments (without duplication for purposes of the covenant described in the section “—*Certain Covenants—Limitation on Restricted Payments*”); *provided*, that, if an Investment is made pursuant to this clause in a Person that is not a Restricted Subsidiary and such Person subsequently becomes a Restricted Subsidiary, such Investment shall thereafter be deemed to have been made pursuant to clause (1) or (2) of the definition of “Permitted Investments” and not this clause;
- (18) Investments in joint ventures and similar entities and Unrestricted Subsidiaries having an aggregate fair market value, when taken together with all other Investments made pursuant to this clause that are at the time outstanding, not to exceed the greater of €375 million and 3.0% of Total Assets at the time of such Investment (with the fair market value of each Investment being measured at the time made and without giving effect to subsequent changes in value); and
- (19) Prior to the Completion Date, Investments of all or a portion of the Escrowed Proceeds permitted under the Notes Escrow Agreement.

“*Permitted Issuer Investments*” means Investments:

- (1) in cash, Cash Equivalents, Temporary Cash Investments and Investment Grade Securities;
- (2) in the Notes, the Existing Senior Secured Notes and the Term Loans;
- (3) in any other Indebtedness of the Issuer permitted to be Incurred under the Indenture;
- (4) in any Issuer Proceeds Loan and other intra-group loans; and
- (5) prior to the Completion Date, Investments of all or a portion of the Escrowed Proceeds permitted under the Notes Escrow Agreement.

“*Permitted Issuer Liens*” means:

- (1) Permitted Collateral Liens; and
- (2) Liens described in one or more of clauses (4), (5), (9), (11), (12), (13), (22), (27) (only in respect of Liens on cash, Cash Equivalents or other property arising in connection with the defeasance, discharge or redemption of Indebtedness) and (28) of the definition of Permitted Liens.

“*Permitted Liens*” means, with respect to any Person:

- (1) Liens on assets or property of a Restricted Subsidiary that is not a Guarantor securing Indebtedness of such Restricted Subsidiary or another Restricted Subsidiary that is not a Guarantor;
- (2) pledges, deposits or Liens under workmen’s compensation laws, unemployment insurance laws, social security laws or similar legislation, or insurance related obligations (including pledges or deposits securing liability to insurance carriers under insurance or self-insurance arrangements and including Liens on insurance policies and proceeds thereof, or other deposits, to secure insurance premium financings), or in connection with bids, tenders, completion guarantees, contracts (other than for borrowed money) or leases, or to secure utilities, licenses, public or statutory obligations, or to secure surety, indemnity, judgment, appeal or performance bonds, guarantees of government contracts (or other similar bonds, instruments or obligations), or as security for contested taxes or import or customs duties or for the payment of rent, or other obligations of like nature, in each case Incurred in the ordinary course of business;
- (3) Liens imposed by law, including carriers’, warehousemen’s, mechanics’, landlords’, materialmen’s and repairmen’s or other like Liens, in each case for sums not yet overdue for a period of more than 60 days or that are bonded or being contested in good faith by appropriate proceedings;

- (4) Liens for taxes, assessments or other governmental charges not yet subject to penalties for non-payment or which are being contested in good faith by appropriate proceedings; *provided* that appropriate reserves required pursuant to IFRS have been made in respect thereof;
- (5) (a) Liens in favor of issuers of surety, performance or other bonds, guarantees or letters of credit or bankers' acceptances (not issued to support Indebtedness for borrowed money) issued pursuant to the request of and for the account of Altice International or any Restricted Subsidiary in the ordinary course of its business and (b) Liens in connection with cash management programs established in the ordinary course of business;
- (6) encumbrances, ground leases, easements (including reciprocal easement agreements), survey exceptions, or reservations of, or rights of others for, licenses, rights of way, sewers, electric lines, telegraph and telephone lines and other similar purposes, or zoning, building codes or other restrictions (including minor defects or irregularities in title and similar encumbrances) as to the use of real properties or Liens incidental to the conduct of the business of Altice International and the Restricted Subsidiaries or to the ownership of its properties which do not in the aggregate materially adversely affect the value of said properties or materially impair their use in the operation of the business of Altice International and the Restricted Subsidiaries;
- (7) Liens on assets or property of Altice International or any Restricted Subsidiary securing Hedging Obligations permitted under the Indenture;
- (8) leases, licenses, subleases and sublicenses of assets (including real property and intellectual property rights), in each case entered into in the ordinary course of business;
- (9) Liens arising out of judgments, decrees, orders or awards not giving rise to an Event of Default and notices of *lis pendens* and associated rights so long as any appropriate legal proceedings which may have been duly initiated for the review of such judgment, decree, order, award or notice have not been finally terminated or the period within which such proceedings may be initiated has not expired;
- (10) Liens on assets or property of Altice International or any Restricted Subsidiary (including Capital Stock) for the purpose of securing Capitalized Lease Obligations or Purchase Money Obligations, or securing the payment of all or a part of the purchase price of, or securing other Indebtedness Incurred to finance or refinance the acquisition, improvement or construction of, assets or property acquired or constructed in the ordinary course of business; *provided* that (a) the aggregate principal amount of Indebtedness secured by such Liens is otherwise permitted to be Incurred under the Indenture (excluding Indebtedness Incurred pursuant to the first paragraph of the covenant described under "*Certain Covenants—Limitation on Indebtedness*") and (b) any such Lien may not extend to any assets or property of Altice International or any Restricted Subsidiary other than assets or property acquired, improved, constructed or leased with the proceeds of such Indebtedness and any improvements or accessions to such assets and property;
- (11) Liens arising by virtue of any statutory or common law provisions relating to banker's Liens, rights of set-off or similar rights and remedies as to deposit accounts or other funds maintained with a depository or financial institution;
- (12) Liens arising from Uniform Commercial Code financing statement filings (or similar filings in other applicable jurisdictions) regarding operating leases entered into by Altice International and the Restricted Subsidiaries in the ordinary course of business;
- (13) (a) with respect to Altice International and its Restricted Subsidiaries (other than HOT and its Subsidiaries and NewCo OMT and its Subsidiaries) Liens existing on or provided for or required to be granted under written agreements existing on the Issue Date after giving effect to the Transactions and the Issuance of the Notes and the application of the proceeds thereof (including after such proceeds are released from the Escrow Accounts); (b) with respect to HOT and its Subsidiaries, Liens existing on, or provided for or required to be granted under written agreements existing on December 12, 2012 after giving effect to the December 2012 Transactions, including, for avoidance of doubt, the second lien floating charge to secure certain payment obligations of HOT to the State of Israel pursuant to a royalty agreement as in effect on December 12, 2012 and (c) with respect to NewCo OMT and its Subsidiaries, Liens existing on, or provided for or required to be granted under written agreements existing on, July 5, 2013 after giving effect to the July 2013 Transactions;
- (14) Liens on property, other assets or shares of stock of a Person at the time such Person becomes a Restricted Subsidiary (or at the time Altice International or a Restricted Subsidiary acquires such property, other assets or shares of stock, including any acquisition by means of a merger, consolidation or other business combination transaction with or into Altice International or any Restricted Subsidiary); *provided, however*, that such Liens are not created, Incurred or assumed in anticipation of or in connection with such other Person becoming a

Restricted Subsidiary (or such acquisition of such property, other assets or stock); *provided, further*, that such Liens are limited to all or part of the same property, other assets or stock (plus improvements, accession, proceeds or dividends or distributions in connection with the original property, other assets or stock) that secured (or, under the written arrangements under which such Liens arose, could secure) the obligations to which such Liens relate;

- (15) Liens on assets or property of Altice International or any Restricted Subsidiary securing Indebtedness or other obligations of Altice International or such Restricted Subsidiary owing to Altice International or another Restricted Subsidiary, or Liens in favor of Altice International or any Restricted Subsidiary;
- (16) Liens securing Refinancing Indebtedness Incurred to refinance Indebtedness that was previously so secured, and permitted to be secured under the Indenture; *provided* that any such Lien is limited to all or part of the same property or assets (plus improvements, accessions, proceeds or dividends or distributions in respect thereof) that secured (or, under the written arrangements under which the original Lien arose, could secure) the Indebtedness being refinanced or is in respect of property that is or could be the security for or subject to a Permitted Lien hereunder;
- (17) any interest or title of a lessor under any Capitalized Lease Obligation or operating lease;
- (18) (a) mortgages, liens, security interest, restrictions, encumbrances or any other matters of record that have been placed by any government, statutory or regulatory authority, developer, landlord or other third party on property over which Altice International or any Restricted Subsidiary has easement rights or on any leased property and subordination or similar arrangements relating thereto and (b) any condemnation or eminent domain proceedings affecting any real property;
- (19) any encumbrance or restriction (including put and call arrangements) with respect to Capital Stock of, or assets owned by, any joint venture or similar arrangement pursuant to any joint venture or similar agreement;
- (20) Liens on property or assets under construction (and related rights) in favor of a contractor or developer or arising from progress or partial payments by a third party relating to such property or assets;
- (21) Liens on Receivables Assets Incurred in connection with a Qualified Receivables Financing;
- (22) Liens on Escrowed Proceeds for the benefit of the related holders of debt securities or other Indebtedness (or the underwriters or arrangers thereof) or on cash set aside at the time of the Incurrence of any Indebtedness or government securities purchased with such cash, in either case to the extent such cash or government securities prefund the payment of interest on such Indebtedness and are held in an escrow account or similar arrangement to be applied for such purpose;
- (23) bankers' Liens, Liens on specific items of inventory or other goods (and the proceeds thereof) of any Person securing such Person's obligations in respect of bankers' acceptances issued or created in the ordinary course of business of such Person to facilitate the purchase, shipment or storage of such inventory or other goods and Liens securing or arising by reason of any netting or set-off arrangement entered into in the ordinary course of banking or other trading activities;
- (24) Liens arising out of conditional sale, title retention, hire purchase, consignment or similar arrangements for the sale of goods entered into in the ordinary course of business, and pledges of goods, the related documents of title and/or other related documents arising or created in the ordinary course of business or operations as Liens only for Indebtedness to a bank or financial institution directly relating to the goods or documents on or over which the pledge exists;
- (25) Permitted Collateral Liens, Permitted HOT Proceeds Note Collateral Liens and Permitted OMT Proceeds Loans Collateral Liens;
- (26) Liens on Capital Stock or other securities or assets of any Unrestricted Subsidiary that secure Indebtedness of such Unrestricted Subsidiary;
- (27) any security granted over Cash Equivalents in connection with the disposal thereof to a third party and Liens on cash, Cash Equivalents or other property arising in connection with the defeasance, discharge or redemption of Indebtedness;

- (28) (a) Liens created for the benefit of or to secure, directly or indirectly, the Notes, (b) Liens pursuant to the Intercreditor Agreement and (c) Liens in respect of property and assets securing Indebtedness if the recovery in respect of such Liens is subject to loss-sharing or similar provisions as among the Holders of the Notes and the creditors of such Indebtedness pursuant to the Intercreditor Agreement or an Additional Intercreditor Agreement;
- (29) Liens created on any asset of Altice International or a Restricted Subsidiary established to hold assets of any stock option plan or any other management or employee benefit or incentive plan or unit trust of Altice International or a Restricted Subsidiary securing any loan to finance the acquisition of such assets; and
- (30) Liens; *provided* that the maximum amount of Indebtedness secured in the aggregate at any one time pursuant to this clause (30) does not exceed the greater of €125 million and 1% of Total Assets.

“*Permitted OMT Proceeds Loans Collateral Liens*” means:

- (1) Liens on OMT Proceeds Loans Collateral that are described in one or more of clauses (2), (3), (4), (5), (6), (8), (9), (11), (12), (13), (18), (20), (23), (24) and (28) of the definition of “Permitted Liens”; and
- (2) Liens on the OMT Proceeds Loans Collateral to secure (a) Indebtedness that is permitted to be Incurred under clauses (1) (which may be Super Priority Indebtedness), (2)(a) (in the case of (2)(a), to the extent such Guarantee is in respect of Indebtedness otherwise permitted to be secured and specified in this clause (2) of this definition of Permitted OMT Proceeds Loans Collateral Liens) and clause (16) under the second paragraph of the covenant described under “—*Certain Covenants—Limitation on Indebtedness*”), (b) any Refinancing Indebtedness in respect of Indebtedness referred to in this clause (2) and (c) any Issuer Proceeds Loans Incurred in accordance with the third paragraph under the heading “—*Certain Covenants—Limitation on Indebtedness*” under which NewCo OMT or any of its Subsidiaries is the borrower or issuer, *provided, however*, that (i) such Lien shall rank *pari passu* or junior to the Liens securing the OMT Proceeds Loans; (ii) in each case, all property and assets (including, without limitation, the OMT Proceeds Loans Collateral) securing such Indebtedness also secure the OMT Proceeds Loans on a senior or *pari passu* basis; and (iii) each of the parties thereto and the Issuer as lender under the OMT Proceeds Loan will have entered into an intercreditor agreement containing terms, as determined in good faith by an Officer of Altice International, not materially less favorable to such lender than the terms of the Intercreditor Agreement with respect to the Holders of the Notes.

“*Person*” means any individual, corporation, partnership, joint venture, association, joint-stock company, trust, unincorporated organization, limited liability company, government or any agency or political subdivision thereof or any other entity.

“*Preferred Stock*”, as applied to the Capital Stock of any Person, means Capital Stock of any class or classes (however designated) which is preferred as to the payment of dividends or as to the distribution of assets upon any voluntary or involuntary liquidation or dissolution of such Person, over shares of Capital Stock of any other class of such Person.

“*Pro forma EBITDA*” means, for any period, the Consolidated EBITDA of Altice International and the Restricted Subsidiaries, *provided* that for the purposes of calculating Pro forma EBITDA for such period, if, as of such date of determination:

- (1) since the beginning of such period Altice International or any Restricted Subsidiary has disposed of any company, any business, or any group of assets constituting an operating unit of a business or otherwise ceases to be a Restricted Subsidiary (and is not a Restricted Subsidiary at the end of such period) (any such disposition, a “Sale”) or if the transaction giving rise to the need to calculate the Consolidated Net Leverage Ratio or Consolidated Net Senior Secured Leverage Ratio is such a Sale, Pro forma EBITDA for such period will be reduced by an amount equal to the Consolidated EBITDA (if positive) attributable to the assets which are the subject of such Sale for such period or increased by an amount equal to the Consolidated EBITDA (if negative) attributable thereto for such period; *provided* that if any such sale constitutes “discontinued operations” in accordance with IFRS, Consolidated Net Income shall be reduced by an amount equal to the Consolidated Net Income (if positive) attributable to such operations for such period or increased by an amount equal to the Consolidated Net Income (if negative) attributable thereto for such period;
- (2) since the beginning of such period, a Parent, Altice International or any Restricted Subsidiary (by merger or otherwise) has made an Investment in any Person that thereby becomes a Restricted Subsidiary, or otherwise has acquired any company, any business, or any group of assets constituting an operating unit of a business or a Person otherwise becomes a Restricted Subsidiary (and remains a Restricted Subsidiary at the end of such period) (any such Investment, acquisition or designation, a “Purchase”), including any such Purchase occurring in connection with a transaction causing a calculation to be made hereunder, Pro forma EBITDA for such period

will be calculated after giving *pro forma* effect thereto as if such Purchase occurred on the first day of such period; and

- (3) since the beginning of such period, any Person (that became a Restricted Subsidiary or was merged or otherwise combined with or into Altice International or any Restricted Subsidiary since the beginning of such period) will have made any Sale or any Purchase that would have required an adjustment pursuant to clause (1) or (2) above if made by Altice International or a Restricted Subsidiary since the beginning of such period, Pro forma EBITDA for such period will be calculated after giving *pro forma* effect thereto as if such Sale or Purchase occurred on the first day of such period.

For the purposes of this definition and the definitions of Consolidated EBITDA, Consolidated Income Taxes, Consolidated Interest Expense and Consolidated Net Income, Consolidated Net Senior Secured Leverage Ratio and Consolidated Net Leverage Ratio (a) whenever *pro forma* effect is to be given to any transaction (including, without limitation, transactions listed in clauses (1)-(3) hereof) or calculation hereunder or such other definitions, the pro forma calculations will be as determined in good faith by a responsible financial or accounting officer of Altice International or an Officer of the Issuer (including in respect of anticipated expense and cost reductions and synergies (other than revenue synergies)) (calculated on a *pro forma* basis as though such expense and cost reductions and synergies had been realized on the first day of the period for which Pro forma EBITDA is being determined and as though such cost savings, operating expense reductions and synergies were realized during the entirety of such period), (b) in determining the amount of Indebtedness outstanding on any date of determination, *pro forma* effect shall be given to any Incurrence, repayment, repurchase, defeasance or other acquisition, retirement or discharge of Indebtedness as if such transaction had occurred on the first day of the relevant period and (c) if any Indebtedness bears a floating rate of interest and is being given *pro forma* effect, the interest on such Indebtedness shall be calculated as if the rate in effect on the date of determination had been the applicable rate for the entire period (taking into account any Hedging Obligations applicable to such Indebtedness if such Hedging Obligation has a remaining term in excess of 12 months).

“*PT OpCo*” refers to MEO—Serviços de Comunicações e Multimédia, S.A., a public limited liability company (*sociedade anónima*) incorporated under the laws of Portugal with registration number 504 615 947, which was formerly known as PT Comunicações, S.A. and is the surviving entity from the merger of Meo, S.A. into PT Comunicações, S.A. on December 29, 2014.

“*Public Debt*” means any Indebtedness consisting of bonds, debentures, notes or other similar debt securities issued in (1) a public offering registered under the Securities Act or (2) a private placement to institutional investors that is underwritten for resale in accordance with Rule 144A or Regulation S under the Securities Act, whether or not it includes registration rights entitling the holders of such debt securities to registration thereof with the SEC for public resale.

“*Public Offering*” means any offering, including an Initial Public Offering, of shares of common stock or other common equity interests that are listed on an exchange or publicly offered (which shall include an offering pursuant to Rule 144A and/or Regulation S under the Securities Act to professional market investors or similar persons).

“*Public Offering Expenses*” means expenses Incurred by any Parent in connection with any Public Offering or any offering of Public Debt (whether or not successful):

- (1) where the net proceeds of such offering are intended to be received by or contributed or loaned to Altice International or a Restricted Subsidiary;
- (2) in a pro-rated amount of such expenses in proportion to the amount of such net proceeds intended to be so received, contributed or loaned; or
- (3) otherwise on an interim basis prior to completion of such offering so long as any Parent shall cause the amount of such expenses to be repaid to Altice International or the relevant Restricted Subsidiary out of the proceeds of such offering promptly if completed, in each case, to the extent such expenses are not paid by another Subsidiary of such Parent.

“*Purchase Money Obligations*” means any Indebtedness Incurred to finance or refinance the acquisition, leasing, construction or improvement of property (real or personal) or assets (including Capital Stock), and whether acquired through the direct acquisition of such property or assets or the acquisition of the Capital Stock of any Person owning such property or assets, or otherwise.

“*Qualified Receivables Financing*” means any Receivables Financing of a Receivables Subsidiary that meets the following conditions: (1) an Officer or the Board of Directors of Altice International shall have determined in good faith that such Qualified Receivables Financing (including financing terms, covenants, termination events and other provisions) is in the aggregate economically fair and reasonable to Altice International and the Receivables Subsidiary,

(2) all sales of accounts receivable and related assets to the Receivables Subsidiary are made at fair market value (as determined in good faith by Altice International), and (3) the financing terms, covenants, termination events and other provisions thereof shall be on market terms (as determined in good faith by Altice International) and may include Standard Securitization Undertakings.

The grant of a security interest in any accounts receivable of Altice International or any Restricted Subsidiary (other than a Receivables Subsidiary) to secure Indebtedness under a Credit Facility or Indebtedness in respect of the Notes shall not be deemed a Qualified Receivables Financing.

“*Rating Agencies*” means Moody’s and S&P or, in the event Moody’s or S&P no longer assigns a rating to the Notes, any other Nationally Recognized Statistical Rating Organization who assigns a rating to the Notes in lieu of the ratings by Moody’s or S&P.

“*Rating Date*” means the date which is 90 days prior to the earlier of (1) a Change of Control; and (2) public notice of the occurrence of a Change of Control or of the intention of the Issuer to effect a Change of Control.

“*Rating Decline*” means the decrease in the rating of the Notes of a series by at least one of the Rating Agencies by one or more gradations (including gradations within rating categories as well as between rating categories) from its rating on the Rating Date or the withdrawal of a rating of the Notes of such series by any of the Rating Agencies on, or within 60 days after, the earlier of the date of public notice of the occurrence of a Change of Control or of the intention of the Issuer to effect a Change of Control or the occurrence of a Change of Control (which period shall be extended so long as the rating of the Notes of such series is under publicly announced consideration by any of the Rating Agencies).

If no Rating Agency announces an action with regard to its rating of the Notes of a series after the occurrence of a Change of Control, the Issuer shall request each Rating Agency to confirm its rating of the Notes of such series before the end of such 60-day period.

“*Receivable*” means a right to receive payment arising from a sale or lease of goods or services by a Person pursuant to an arrangement with another Person pursuant to which such other Person is obligated to pay for goods or services under terms that permit the purchase of such goods and services on credit, as determined on the basis of IFRS.

“*Receivables Assets*” means any assets that are or will be the subject of a Qualified Receivables Financing.

“*Receivables Fees*” means distributions or payments made directly or by means of discounts with respect to any participation interest issued or sold in connection with, and other fees paid to a Person that is not a Restricted Subsidiary in connection with, any Receivables Financing.

“*Receivables Financing*” means any transaction or series of transactions that may be entered into by Altice International or any of its Subsidiaries pursuant to which Altice International or any of its Subsidiaries may sell, convey or otherwise transfer to (a) a Receivables Subsidiary (in the case of a transfer by Altice International or any of its Subsidiaries), or (b) any other Person (in the case of a transfer by a Receivables Subsidiary), or may grant a security interest in, any accounts receivable (whether now existing or arising in the future) of Altice International or any of its Subsidiaries, and any assets related thereto, including all collateral securing such accounts receivable, all contracts and all guarantees or other obligations in respect of such accounts receivable, proceeds of such accounts receivable and other assets which are customarily transferred or in respect of which security interest are customarily granted in connection with asset securitization transactions involving accounts receivable and any Hedging Obligations entered into by Altice International or any such Subsidiary in connection with such accounts receivable.

“*Receivables Repurchase Obligation*” means any obligation of a seller of receivables in a Qualified Receivables Financing to repurchase receivables arising as a result of a breach of a representation, warranty or covenant or otherwise, including as a result of a receivable or portion thereof becoming subject to any asserted defense, dispute, off-set or counterclaim of any kind as a result of any action taken by, any failure to take action by or any other event relating to the seller.

“*Receivables Subsidiary*” means a Wholly Owned Subsidiary of Altice International (other than the Issuer) (or another Person formed for the purposes of engaging in a Qualified Receivables Financing with Altice International in which Altice International or any Subsidiary of Altice International makes an Investment and to which Altice International or any Subsidiary of Altice International transfers accounts receivable and related assets) which engages in no activities other than in connection with the financing of accounts receivable of Altice International and its Subsidiaries, all proceeds thereof and all rights (contractual or other), collateral and other assets relating thereto, and any business or activities incidental or related to such business, and which is designated by the Board of Directors of Altice International (as provided below) as a Receivables Subsidiary and:

- (1) no portion of the Indebtedness or any other obligations (contingent or otherwise) of which (i) is guaranteed by Altice International or any other Restricted Subsidiary (excluding guarantees of obligations (other than the principal of, and interest on, Indebtedness) pursuant to Standard Securitization Undertakings), (ii) is subject to terms that are substantially equivalent in effect to a guarantee of any losses on securitized or sold receivables by Altice International or any other Restricted Subsidiary, (iii) is recourse to or obligates Altice International or any other Restricted Subsidiary in any way other than pursuant to Standard Securitization Undertakings, or (iv) subjects any property or asset of Altice International or any Restricted Subsidiary, directly or indirectly, contingently or otherwise, to the satisfaction thereof, other than pursuant to Standard Securitization Undertakings;
- (2) with which neither Altice International nor any other Restricted Subsidiary has any material contract, agreement, arrangement or understanding other than on terms which Altice International reasonably believes to be no less favorable to Altice International or such Restricted Subsidiary than those that might be obtained at the time from Persons that are not Affiliates of Altice International; and
- (3) to which neither Altice International nor any other Restricted Subsidiary has any obligation to maintain or preserve such entity's financial condition or cause such entity to achieve certain levels of operating results.

Any such designation by the Board of Directors of Altice International shall be evidenced to the Trustee by filing with the Trustee a copy of the resolution of the Board of Directors of Altice International giving effect to such designation and an Officer's Certificate certifying that such designation complied with the foregoing conditions.

"*Refinance*" means refinance, refund, replace, renew, repay, modify, restate, defer, substitute, supplement, reissue, resell, extend or increase (including pursuant to any defeasance or discharge mechanism) and the terms "*refinances*", "*refinanced*" and "*refinancing*" as used for any purpose in the Indenture shall have a correlative meaning.

"*Refinancing Indebtedness*" means Indebtedness of Altice International or any Restricted Subsidiary to refund, refinance, replace, exchange, renew, repay or extend (including pursuant to any defeasance or discharge mechanism) any Indebtedness existing on the date of the Indenture or Incurred in compliance with the Indenture including Indebtedness that refinances Refinancing Indebtedness; *provided, however*, that:

- (1) if the Indebtedness being refinanced constitutes Subordinated Indebtedness, the Refinancing Indebtedness has a final stated maturity at the time such Refinancing Indebtedness is Incurred that is the same as or later than the final stated maturity of the Indebtedness being refinanced or, if shorter, the Notes;
- (2) such Refinancing Indebtedness is Incurred in an aggregate principal amount (or if issued with original issue discount, an aggregate issue price) that is equal to or less than the sum of the aggregate principal amount (or if issued with original issue discount, the aggregate accreted value) then outstanding of the Indebtedness being refinanced (plus, without duplication, any additional Indebtedness Incurred to pay interest or premiums required by the instruments governing such existing Indebtedness and costs, expenses and fees Incurred in connection therewith);
- (3) if the Indebtedness being refinanced is expressly subordinated to the Notes or any Note Guarantee, such Refinancing Indebtedness is subordinated to the Notes or such Note Guarantee, as applicable, on terms at least as favorable to the Holders as those contained in the documentation governing the Indebtedness being refinanced; and
- (4) if the Issuer or any Guarantor was the obligor on the Indebtedness being refinanced, such Indebtedness is incurred either by the Issuer or by a Guarantor.

provided, however, that Refinancing Indebtedness shall not include (i) Indebtedness of the Issuer or HoldCo that refinances Indebtedness of an Unrestricted Subsidiary, (ii) Indebtedness of the Issuer owing to and held by Altice International or any Restricted Subsidiary, Indebtedness of Altice International owing to and held by the Issuer or any Restricted Subsidiary or Indebtedness of a Restricted Subsidiary owing to and held by Altice International or any other Restricted Subsidiary or (iii) any Issuer Proceeds Loan or any HoldCo Proceeds Loan.

Refinancing Indebtedness in respect of any Credit Facility or any other Indebtedness may be Incurred from time to time after the termination, discharge, or repayment of any such Credit Facility or other Indebtedness.

"*Related Taxes*" means, without duplication (including, for the avoidance of doubt, without duplication of any amounts paid pursuant to any Tax Sharing Agreement):

- (1) any Taxes, including sales, use, transfer, rental, ad valorem, value added, stamp, property, consumption, franchise, license, capital, registration, business, customs, net worth, gross receipts, excise, occupancy, intangibles or similar Taxes (other than (x) Taxes measured by income and (y) withholding taxes), required to be paid (*provided* such Taxes are in fact paid) by any Parent by virtue of its:
 - (a) being incorporated or otherwise being established or having Capital Stock outstanding (but not by virtue of owning stock or other equity interests of any corporation or other entity other than, directly or indirectly, HoldCo, Altice International or any Subsidiary of Altice International);
 - (b) issuing or holding Subordinated Shareholder Funding;
 - (c) being a holding company parent, directly or indirectly, of Altice International or any Subsidiary of Altice International;
 - (d) receiving dividends from or other distributions in respect of the Capital Stock of, directly or indirectly, Altice International or any Subsidiary of Altice International; or
 - (e) having made any payment in respect to any of the items for which the Issuer or Altice International is permitted to make payments to any Parent pursuant to “—*Certain Covenants—Limitation on Restricted Payments*”; or
- (2) if and for so long as the Issuer or Altice International is a member of a group filing a consolidated or combined tax return with any Parent, any Taxes measured by income for which such Parent is liable up to an amount not to exceed with respect to such Taxes the amount of any such Taxes that Altice International and Subsidiaries of Altice International would have been required to pay on a separate company basis or on a consolidated basis if Altice International and the Subsidiaries of Altice International had paid tax on a consolidated, combined, group, affiliated or unitary basis on behalf of an affiliated group consisting only of Altice International and the Subsidiaries of Altice International.

“*Representative*” means any trustee, agent or representative (if any) for an issue of Indebtedness or the provider of Indebtedness (if provided on a bilateral basis), as the case may be.

“*Restricted Investment*” means any Investment other than a Permitted Investment.

“*Restricted Subsidiary*” means a Subsidiary of Altice International other than an Unrestricted Subsidiary.

“*Revolving Credit Facilities*” means the Existing Revolving Credit Facilities and the Additional Revolving Credit Facilities.

“*S&P*” means Standard & Poor’s Investors Ratings Services or any of its successors or assigns that is a Nationally Recognized Statistical Rating Organization.

“*SEC*” means the U.S. Securities and Exchange Commission.

“*Securities Act*” means the U.S. Securities Act of 1933, as amended, and the rules and regulations of the SEC promulgated thereunder, as amended.

“*Security Agent*” means Citibank, N.A., London Branch acting as security agent pursuant to the Intercreditor Agreement or such successor Security Agent or any delegate thereof as may be appointed thereunder or any such security agent, delegate or successor thereof pursuant to an Additional Intercreditor Agreement.

“*Security Documents*” means the security agreements, pledge agreements, collateral assignments, and any other instrument and document executed and delivered pursuant to the Indenture or otherwise or any of the foregoing, as the same may be amended, supplemented or otherwise modified from time to time, creating the security interests in the Notes Collateral as contemplated by the Indenture.

“*Senior Credit Facilities*” means the Existing Senior Credit Facility and the New Senior Credit Facility.

“*Senior Secured Indebtedness*” means, with respect to any Person as of any date of determination, any Indebtedness for borrowed money that is Incurred under the first paragraph of the covenant described under “*Certain Covenants—Limitation on Indebtedness*” or clauses (1), (4)(a) and (b), (5), (7), (14) or (16) of the second paragraph of the covenant described under “*Certain Covenants—Limitation on Indebtedness*” and any Refinancing Indebtedness in respect of the

foregoing; *provided* that, if such Indebtedness is Incurred by the Issuer or any Guarantor, such Indebtedness (other than Indebtedness Incurred pursuant to clause (4)(b) of the second paragraph of the covenant described under “*Certain Covenants—Limitation on Indebtedness*”) is in each case secured by a Lien on the Notes Collateral on a basis *pari passu* with or senior to the security in favor of the Notes (other than (i) Liens on the Capital Stock of the Issuer, Cool and Altice Holdings and (ii) Liens on the HoldCo Proceeds Loans and the Subordinated Shareholder Loan, if any, in each case, that secure Guarantees of Indebtedness of HoldCo Incurred pursuant clauses (4), (5)(y), (14) or (16) of the second paragraph of the covenant described under “*Certain Covenants—Limitation on Indebtedness*”).

“*Significant Subsidiary*” means any Restricted Subsidiary that meets any of the following conditions:

- (1) Altice International’s and the Restricted Subsidiaries’ investments in and advances to the Restricted Subsidiary exceed 10% of total assets of Altice International and the Restricted Subsidiaries on a consolidated basis as of the end of the most recently completed fiscal year;
- (2) Altice International’s and the Restricted Subsidiaries’ proportionate share of the total assets (after intercompany eliminations) of the Restricted Subsidiary exceeds 10% of total assets of Altice International and the Restricted Subsidiaries on a consolidated basis as of the end of the most recently completed fiscal year; or
- (3) if positive, Altice International’s and the Restricted Subsidiaries’ equity in the income from continuing operations before income taxes, extraordinary items and cumulative effect of a change in accounting principle of the Restricted Subsidiary exceeds 10% of such income of Altice International and the Restricted Subsidiaries on a consolidated basis for the most recently completed fiscal year.

“*Similar Business*” means (a) any businesses, services or activities (including marketing) engaged in by Altice International, the Target or any of their Subsidiaries on the Issue Date, (b) broadcast television, broadband and fixed and mobile telephony businesses, including the distribution, sale and for provision of mobile voice and data, fixed-line voice and internet services, transit voice traffic services and other services and equipment in relation thereto and (c) any businesses, services and activities (including marketing) engaged in by Altice International, the Target or any of their Subsidiaries that are (i) related, complementary, incidental, ancillary or similar to any of the foregoing or (ii) are reasonable extensions or developments of any thereof.

“*Standard Securitization Undertakings*” means representations, warranties, covenants, indemnities and guarantees of performance entered into by Altice International or any Subsidiary of Altice International which the Issuer has determined in good faith to be customary in a Receivables Financing, including those relating to the servicing of the assets of a Receivables Subsidiary, it being understood that any Receivables Repurchase Obligation shall be deemed to be a Standard Securitization Undertaking.

“*Stated Maturity*” means, with respect to any installment of interest or principal on any series of Indebtedness, the date on which the payment of interest or principal was scheduled to be paid in the original documentation governing such Indebtedness, and will not include any contingent obligations to repay, redeem or repurchase any such interest or principal prior to the date originally scheduled for the payment thereof.

“*Subordinated Indebtedness*” means, in the case of the Issuer, any Indebtedness (whether outstanding on the Issue Date or thereafter Incurred) which is expressly subordinated or junior in right of payment to the Notes or pursuant to a written agreement and, in the case of a Guarantor, any Indebtedness (whether outstanding on the Issue Date or thereafter Incurred) which is expressly subordinated or junior in right of payment to the Note Guarantee of such Guarantor.

“*Subordinated Shareholder Funding*” means, collectively, any funds provided to Altice International by any Parent, any Affiliate of any Parent or any Permitted Holder or any Affiliate thereof, in exchange for or pursuant to any security, instrument or agreement other than Capital Stock, in each case issued to and held by any of the foregoing Persons, together with any such security, instrument or agreement and any other security or instrument other than Capital Stock issued in payment of any obligation under any Subordinated Shareholder Funding; *provided, however*, that such Subordinated Shareholder Funding:

- (1) does not mature or require any amortization, redemption or other repayment of principal or any sinking fund payment prior to the first anniversary of the Stated Maturity of the Notes (other than through conversion or exchange of such funding into Capital Stock (other than Disqualified Stock) of Altice International or any funding meeting the requirements of this definition) or the making of any such payment prior to the first anniversary of the Stated Maturity of the Notes is restricted by the Intercreditor Agreement, an Additional Intercreditor Agreement or another intercreditor agreement;
- (2) does not require, prior to the first anniversary of the Stated Maturity of the Notes, payment of cash interest, cash withholding amounts or other cash gross-ups, or any similar cash amounts or the making of any such payment

prior to the first anniversary of the Stated Maturity of the Notes is restricted by the Intercreditor Agreement or an Additional Intercreditor Agreement;

- (3) contains no change of control or similar provisions and does not accelerate and has no right to declare a default or event of default or take any enforcement action or otherwise require any cash payment, in each case, prior to the date that is six months following the Stated Maturity of the Notes or the payment of any amount as a result of any such action or provision or the exercise of any rights or enforcement action, in each case, prior to the date that is six months following the Stated Maturity of the Notes, is restricted by the Intercreditor Agreement or an Additional Intercreditor Agreement;
- (4) does not provide for or require any security interest or encumbrance over any asset of Altice International or any of the Restricted Subsidiaries; and
- (5) pursuant to its terms or to the Intercreditor Agreement, an Additional Intercreditor Agreement or another intercreditor agreement, is fully subordinated and junior in right of payment to the Notes pursuant to subordination, payment blockage and enforcement limitation terms which are customary in all material respects for similar funding or are no less favorable in any material respect to Holders than those contained in the Intercreditor Agreement as in effect on the Issue Date.

For the avoidance of doubt, Subordinated Shareholder Funding shall include the AI Mandatory Convertible Notes so long as it satisfies the conditions set forth in (1) to (5) above.

“*Subordinated Shareholder Loan*” means the amended and restated interest free loan agreement dated January 11, 2013 between Altice International and Cool pursuant to which Altice International agreed to grant Cool a loan in a maximum aggregate amount of NIS 1.5 billion.

“*Subsidiary*” means, with respect to any Person:

- (1) any corporation, association, or other business entity (other than a partnership, joint venture, limited liability company or similar entity) of which more than 50% of the total ordinary voting power of shares of Capital Stock entitled (without regard to the occurrence of any contingency) to vote in the election of directors, managers or trustees thereof is at the time of determination owned or controlled, directly or indirectly, by such Person or one or more of the other Subsidiaries of that Person or a combination thereof; or
- (2) any partnership, joint venture, limited liability company or similar entity of which:
 - (a) more than 50% of the capital accounts, distribution rights, total equity and voting interests or general or limited partnership interests, as applicable, are owned or controlled, directly or indirectly, by such Person or one or more of the other Subsidiaries of that Person or a combination thereof whether in the form of membership, general, special or limited partnership interests or otherwise; and
 - (b) such Person or any Subsidiary of such Person is a controlling general partner or otherwise controls such entity.

“*Subsidiary Guarantor*” means any Restricted Subsidiary (other than the Issuer) that Guarantees the Notes.

“*Super Priority Indebtedness*” means any Indebtedness incurred under a Credit Facility or Hedging Obligations that is or will be secured by the same Notes Collateral that secures the Notes but has priority over amounts received from the sale of the Notes Collateral pursuant to an enforcement sale or other distressed disposal of such Notes Collateral pursuant to the Intercreditor Agreement or any Additional Intercreditor Agreement.

“*Take-Private Transaction*” refers to the acquisition by Cool and SPV1 of all the outstanding shares of HOT (other than certain share options) and the subsequent delisting from the Tel Aviv Stock Exchange of the shares of HOT, which was completed on December 27, 2012.

“*Target*” means PT Portugal SGPS, S.A., a public limited liability company (*sociedade anónima*) incorporated under the laws of Portugal.

“*Taxes*” has the meaning given to such term under “*Withholding Taxes*”.

“*Tax Sharing Agreement*” means any tax sharing or profit and loss pooling or similar agreement with customary or arm’s-length terms entered into with any Parent or Unrestricted Subsidiary, as the same may be amended, supplemented, waived or otherwise modified from time to time in accordance with the terms thereof and of the Indenture.

“*Temporary Cash Investments*” means any of the following:

- (1) any investment in
 - (a) direct obligations of, or obligations Guaranteed by, (i) the United States of America, (ii) any European Union member state, (iii) the State of Israel, (iv) any country in whose currency funds are being held specifically pending application in the making of an investment or capital expenditure by Altice International or a Restricted Subsidiary in that country with such funds or (v) any agency or instrumentality of any such country or member state, or
 - (b) direct obligations of any country recognized by the United States of America rated at least “A” by S&P or “A-1” by Moody’s (or, in either case, the equivalent of such rating by such organization or, if no rating of S&P or Moody’s then exists, the equivalent of such rating by any Nationally Recognized Statistical Rating Organization);
- (2) overnight bank deposits, and investments in time deposit accounts, certificates of deposit, bankers’ acceptances and money market deposits (or, with respect to foreign banks, similar instruments) maturing not more than one year after the date of acquisition thereof issued by:
 - (a) any institution authorized to operate as a bank in any of the countries or member states referred to in subclause (1)(a) above, or
 - (b) any bank or trust company organized under the laws of any such country or member state or any political subdivision thereof,

in each case, having capital and surplus aggregating in excess of € 250 million (or the foreign currency equivalent thereof) and whose long-term debt is rated at least “A” by S&P or “A-2” by Moody’s (or, in either case, the equivalent of such rating by such organization or, if no rating of S&P or Moody’s then exists, the equivalent of such rating by any Nationally Recognized Statistical Rating Organization) at the time such Investment is made;

- (3) repurchase obligations with a term of not more than 30 days for underlying securities of the types described in clause (1) or (2) above entered into with a Person meeting the qualifications described in clause (2) above;
- (4) Investments in commercial paper, maturing not more than 270 days after the date of acquisition, issued by a Person (other than Altice International or any of its Subsidiaries), with a rating at the time as of which any Investment therein is made of “P-2” (or higher) according to Moody’s or “A-2” (or higher) according to S&P (or, in either case, the equivalent of such rating by such organization or, if no rating of S&P or Moody’s then exists, the equivalent of such rating by any Nationally Recognized Statistical Rating Organization);
- (5) Investments in securities maturing not more than one year after the date of acquisition issued or fully Guaranteed by any state, commonwealth or territory of the United States of America, any European Union member state or by any political subdivision or taxing authority of any such state, commonwealth, territory, country or member state, and rated at least “BBB-” by S&P or “Baa3” by Moody’s (or, in either case, the equivalent of such rating by such organization or, if no rating of S&P or Moody’s then exists, the equivalent of such rating by any Nationally Recognized Statistical Rating Organization);
- (6) bills of exchange issued in the United States of America or a member state of the European Union eligible for rediscount at the relevant central bank and accepted by a bank (or any dematerialized equivalent);
- (7) any money market deposit accounts issued or offered by a commercial bank organized under the laws of a country that is a member of the Organization for Economic Co-operation and Development, in each case, having capital and surplus in excess of €250 million (or the foreign currency equivalent thereof) or whose long term debt is rated at least “A” by S&P or “A-2” by Moody’s (or, in either case, the equivalent of such rating by such organization or, if no rating of S&P or Moody’s then exists, the equivalent of such rating by any Nationally Recognized Statistical Rating Organization) at the time such Investment is made;

- (8) investment funds investing 95% of their assets in securities of the type described in clauses (1) through (7) above (which funds may also hold reasonable amounts of cash pending investment and/or distribution); and
- (9) investments in money market funds complying with the risk limiting conditions of Rule 2a-7 (or any successor rule) of the SEC under the U.S. Investment Company Act of 1940, as amended.

“*Term Loans*” means the Existing Term Loans and the New Term Loans.

“*Total Assets*” means the consolidated total assets of Altice International and the Restricted Subsidiaries as shown on the most recent consolidated balance sheet of Altice International prepared on the basis of IFRS prior to the relevant date of determination calculated to give *pro forma* effect to any Purchase and Sales that have occurred subsequent to such period, including any such Purchase to be made with the proceeds of such Indebtedness giving rise to the need to calculate Total Assets.

“*Transactions*” means the Acquisition and the other transactions described under “*The Transactions*” elsewhere in this Offering Memorandum, including the issuance of the Notes and the New Senior Notes, the entry into, and drawing of loans under, the Additional Revolving Credit Facilities and the New Senior Credit Facility.

“*Treasury Rate*” means, as of the applicable redemption date, the yield to maturity as of such redemption date of United States Treasury securities with a constant maturity (as compiled and published in the most recent Federal Reserve Statistical Release H. 15 (519) that has become publicly available at least two (2) Business Days prior to such redemption date (or, if such Statistical Release is no longer published, any publicly available source of similar market data)) most nearly equal to the period from such redemption date to February 15, 2018; *provided* that if the period from such redemption date to February 15, 2018 is less than one year, the weekly average yield on actually traded United States Treasury securities adjusted to a constant maturity of one year will be used.

“*Tricom*” means Tricom S.A., a *sociedad anónima* incorporated and existing under the laws of the Dominican Republic.

“*U.S. GAAP*” means generally accepted accounting principles in the United States of America as in effect from time to time.

“*U.S. Government Obligations*” means securities that are (a) direct obligations (or certificates representing an ownership interest in such obligations) of the United States of America, for the timely payment of which its full faith and credit is pledged or (b) obligations (or certificates representing an ownership interest in such obligations) of a Person controlled or supervised by and acting as an agency or instrumentality of the United States of America, rated at least “*A-1*” by S&P or “*P-1*” by Moody’s, and which are not callable or redeemable at the option of the issuer thereof.

“*Uniform Commercial Code*” means the New York Uniform Commercial Code.

“*Unrestricted Subsidiary*” means:

- (1) Holdco, Green Datacenter and Auberimmo SAS;
- (2) any Subsidiary of Altice International that at the time of determination is an Unrestricted Subsidiary (as designated by the Board of Directors of Altice International in the manner provided below); and
- (3) any Subsidiary of an Unrestricted Subsidiary.

The Board of Directors of Altice International may designate any Subsidiary of Altice International (including any newly acquired or newly formed Subsidiary or a Person becoming a Subsidiary through merger, consolidation or other business combination transaction, or Investment therein) to be an Unrestricted Subsidiary only if:

- (1) such Subsidiary or any of its Subsidiaries does not own any Capital Stock or Indebtedness of, or own or hold any Lien on any property of, the Issuer, Altice International or any other Subsidiary of Altice International which is not a Subsidiary of the Subsidiary to be so designated or otherwise an Unrestricted Subsidiary; and
- (2) such designation and the Investment of Altice International and the Restricted Subsidiaries in such Subsidiary complies with “—*Certain Covenants—Limitation on Restricted Payments*”.

Any such designation by the Board of Directors of Altice International shall be evidenced to the Trustee by filing with the Trustee a copy of the resolution of the Board of Directors of Altice International giving effect to such designation and an Officer’s Certificate certifying that such designation complies with the foregoing conditions.

The Board of Directors of Altice International may designate any Unrestricted Subsidiary to be a Restricted Subsidiary; *provided* that immediately after giving effect to such designation (1) no Default or Event of Default would result therefrom and (2)(x) the Issuer and the Guarantors could Incur at least €1.00 of additional Indebtedness under sub-clause (15) of the second paragraph of the covenant described under “—*Certain Covenants—Limitation on Indebtedness*” or (y) the Consolidated Net Leverage Ratio would be no higher than it was immediately prior to giving effect to such designation, in each case, on a *pro forma* basis taking into account such designation. Any such designation by the Board of Directors shall be evidenced to the Trustee by promptly filing with the Trustee a copy of the resolution of the Board of Directors giving effect to such designation or an Officer’s Certificate certifying that such designation complied with the foregoing provisions.

“*Voting Stock*” of a Person means all classes of Capital Stock of such Person then outstanding and normally entitled to vote in the election of directors.

“*Wholly Owned Subsidiary*” means a Restricted Subsidiary of a Person, all of the Capital Stock of which (other than directors’ qualifying shares or shares required by any applicable law or regulation to be held by a Person other than such Person or another Wholly Owned Subsidiary of such Person) is owned by such Person or another Wholly Owned Subsidiary of such Person.

“*Winreason*” means Winreason—S.A., a public limited liability company (*sociedade anónima*) incorporated under the laws of Portugal.

DESCRIPTION OF SENIOR NOTES

You will find definitions of certain capitalized terms used in this “Description of Senior Notes” under the heading “Certain Definitions”. Certain capitalized terms used in this “Description of Senior Notes” may have different definitions than the same term used in other sections of this Offering Memorandum, including “Description of the Senior Secured Notes.” For purposes of this “Description of Senior Notes”, references to the “Issuer” refer only to Altice Finco S.A.

Altice Finco S.A., a Luxembourg public limited liability company (*société anonyme*), with registered office at 3 Boulevard Royal, L-2449 Luxembourg (the “Issuer”) will be the issuer of the Notes offered hereby. The Issuer is the parent of Altice Financing S.A., a Luxembourg public limited liability company (*société anonyme*), with registered office at 3 Boulevard Royal, L-2449 Luxembourg (the “Senior Secured Notes Issuer”).

The Issuer has issued \$385 million aggregate principal amount of its U.S. dollar-denominated Senior Notes due 2025 (the “Notes”) under an indenture (the “Indenture”), between, *inter alios*, itself, Altice International S.à r.l. (“Altice International”) a private limited company (*société à responsabilité limitée*) incorporated under the laws of Luxembourg, registered with the Luxembourg Register of Commerce and Companies under number B143.725, Deutsche Bank AG, London Branch, as trustee (the “Trustee”), Deutsche Bank Trust Company Americas as US Paying Agent, US Transfer Agent and US Registrar and Citibank, N.A., London Branch, as security agent. The Notes were issued in a private transaction that is not subject to the registration requirements of the Securities Act. The Issuer is a wholly owned subsidiary of Altice International.

Subject to the following three paragraphs, the net proceeds of the offering of the Notes sold on the Issue Date will be loaned by the Issuer to the Senior Secured Notes Issuer. The Senior Secured Notes Issuer has issued Senior Secured Notes due 2023 (the “New Senior Secured Notes”) under an indenture (the “New Senior Secured Notes Indenture”), between, *inter alios*, itself, Altice International, Deutsche Bank AG, London Branch, as trustee (the “Senior Secured Notes Trustee”) and Citibank, N.A., London Branch, as security agent, concurrently with the issuance of the Notes. The net proceeds of the offering of the Notes sold on the Issue Date and loaned to the Senior Secured Notes Issuer, together with the net proceeds of the offering of the Senior Secured Notes sold by the Senior Secured Notes Issuer on the Issue Date, will be loaned by the Senior Secured Notes Issuer pursuant to proceeds loans (the “Finco Proceeds Loans”) to Altice Holdings to enable Altice Holdings to:

- (1) directly or indirectly to acquire (the “Acquisition”) 100% of the outstanding Capital Stock of PT Portugal SGPS, S.A. (the “Target”), together with certain entities identified in the Acquisition Agreement (as defined below) as “Companies within the Transaction Perimeter” (collectively, the “PT Portugal Group”), from Oi, S.A. (the “Seller”) pursuant to the terms of an agreement dated December 9, 2014 among Altice S.A., Altice Portugal and the Seller (the “Acquisition Agreement”); and
- (2) pay fees and expenses related to the foregoing,

(herein referred to collectively as the “Transactions”) as described in this Offering Memorandum under “The Transactions” and “Use of Proceeds”. The date on which the Acquisition is consummated is herein referred to as the “Completion Date”.

The initial purchasers have, concurrently with the closing of the offering of the Notes on the Issue Date, deposited the gross proceeds of this offering of the Notes into an escrow account (the “Escrow Account”) pursuant to the terms of an escrow agreement (the “Notes Escrow Agreement”) dated as of the Issue Date among, *inter alios*, the Issuer, the Trustee and Deutsche Bank AG, London Branch, as Escrow Agent (the “Escrow Agent”). If the Acquisition is not consummated on or prior to June 9, 2016 (the “Escrow Longstop Date”), or upon the occurrence of certain other events, the Notes will be redeemed at a price equal to 100% of the initial issue price of the Notes plus accrued and unpaid interest and Additional Amounts, if any, from the Issue Date to the Special Mandatory Redemption Date (as defined below). The initial purchasers have, concurrently with the closing of the offering of the New Senior Secured Notes on the Issue Date, deposited the gross proceeds of this offering of the New Senior Secured Notes into one or more escrow segregated accounts (the “New Senior Secured Notes Escrow Accounts”) pursuant to the terms of an escrow agreement (the “New Senior Secured Notes Escrow Agreement” and together with the Notes Escrow Agreement, the “Escrow Agreements”) dated as of the Issue Date among, *inter alios*, the Senior Secured Notes Issuer, the New Senior Secured Notes Trustee and Deutsche Bank AG, London Branch, as escrow agent.

The completion of the Acquisition is subject to the conditions set out in the Acquisition Agreement, including the separate approval by the competent regulatory authorities in Portugal and merger-control clearance by the European Commission. As a result, we are unable to predict the date on which the Acquisition will complete. The Escrow Agreements provide that, subject to the conditions in relevant Escrow Agreement, all of the proceeds of the Notes held in the Escrow Account and all of the proceeds of the New Senior Secured Notes held in the New Senior Secured Notes

Escrow Accounts will be released to consummate the Acquisition, and to pay fees and expenses related to the Transactions.

The release of the proceeds of the offering of the Notes from the Escrow Account will be subject to certain conditions. See “*General—Escrow of Proceeds; Special Mandatory Redemption*”.

As of the initial issuance of the Notes, the Notes are obligations solely of the Issuer and are not guaranteed. Although Altice International is party to the Indenture on the Issue Date for purposes of the covenants described below, the Note Guarantee of Altice International will not be effective until the Completion Date (as defined below). Assuming the Completion Date occurs on or prior to the Escrow Longstop Date, on the Completion Date, the Note Guarantee of Altice International will become effective and each of the Senior Secured Notes Issuer, Cool, H. Hadaros 2012, Ltd., Altice Holdings, Altice West Europe, Altice Caribbean, Green, Altice Bahamas, Tricom, Global Interlink, ODO and Winreason, ONI S.G.P.S., Oniteleco, Knewon, Altice Portugal and Cabovisao (subject to the applicable Aggregate Portuguese Security and Guarantee Limit Amount (as defined below)) (collectively, the “*Completion Date Guarantors*”) will execute and deliver a supplemental indenture providing for a Note Guarantee on a senior subordinated basis. Within 90 days following the Completion Date, PT Portugal and PT OpCo (the “*Post-Completion Date Guarantors*”) will execute and deliver a supplemental indenture providing for a Note Guarantee on a senior subordinated basis, subject to the applicable Aggregate Portuguese Security and Guarantee Limit (the date on which the Post-Completion Date Guarantor executes such supplemental indenture being the “*Post-Completion Guarantor Accession Date*”).

The Indenture is unlimited in aggregate principal amount and \$385 million in principal amount of Notes were issued in this offering. We may issue an unlimited principal amount of additional Notes at later dates under the same Indenture (the “*Additional Notes*”); *provided, however*, that we will only be permitted to issue Additional Notes in compliance with the covenants contained in the Indenture, including the covenants restricting the Incurrence of Indebtedness (as described below under “*—Certain Covenants—Limitation on Indebtedness*”) and the Incurrence of Liens (as described below under “*—Certain Covenants—Limitation on Liens*”). The Notes issued in this offering are and, if issued, any Additional Notes will be treated as a single class for all purposes under the Indenture, including, without limitation, with respect to waivers, amendments, redemptions and offers to purchase, except as otherwise stated in the Indenture. However, in order for any Additional Notes to have the same CUSIP number and ISIN as the Notes, such Additional Notes must be fungible with the Notes for U.S. federal income tax purposes. Unless the context otherwise requires, in this “*Description of Senior Notes*”, references to the “*Notes*” include the Notes and any Additional Notes that are actually issued. The terms of the Notes include those set forth in the Indenture. The Indenture is not qualified under, and will not incorporate by reference any of the provisions of, and is not required to be subject to, the U.S. Trust Indenture Act of 1939, as amended.

This “*Description of Senior Notes*” is intended to be an overview of the material provisions of the Notes and the Indenture, and refers to the Intercreditor Agreement, the Notes Escrow Agreement and the Security Documents (as defined below). It does not restate those agreements in their entirety. Since this description of the terms of the Notes is only a summary, you should refer to the Indenture, the form of Notes, the Intercreditor Agreement, the Notes Escrow Agreement and the Security Documents for complete descriptions of the obligations of the Issuer and your rights because they, and not this summary, define your rights as holders of the Notes. Copies of the Indenture, the form of Notes, the Security Documents, the Intercreditor Agreement and the Notes Escrow Agreement are available as set forth under “*Available Information*”. See the section entitled “*Description of Other Indebtedness—Intercreditor Agreement*” for a summary of certain material terms of the Intercreditor Agreement.

The registered holder of a Note will be treated as the owner of such Note for all purposes. Only registered holders will have rights under the Indenture.

General

The Notes

The Notes:

- are general obligations of the Issuer;
- will, prior to the Completion Date, be secured by a first ranking assignment over the Escrowed Property (as defined below) and the rights of the Issuer under the Notes Escrow Agreement;
- will, as of the Completion Date, be guaranteed by the Completion Date Guarantors and within 90 days after the Completion Date (if it occurs), the Notes will be guaranteed by the Post-Completion Date Guarantors and benefit from the security as set forth below under “*—Notes Security*”;

- rank *pari passu* in right of payment with all existing and future Indebtedness of the Issuer that is not subordinated in right of payment to the Notes, including Existing Senior Notes;
- rank senior in right of payment to all existing and future Indebtedness of the Issuer that is expressly subordinated in right of payment to the Notes; and
- are effectively subordinated to all existing and future Indebtedness of the Issuer that is secured by property and assets that do not secure the Notes, to the extent of the value of the property and assets securing such Indebtedness.

The Note Guarantees

Subject to the following paragraphs, on the Completion Date, the Notes will be guaranteed by the Completion Date Guarantors; *provided that* (i) the Note Guarantees of Cabovisao and Altice Portugal together with their guarantees of obligations under the Revolving Credit Facilities, the Guarantee Facility, the Senior Credit Facilities, the Existing Senior Secured Notes, the New Senior Secured Notes, the Existing Senior Notes, certain Hedging Obligations and certain future Indebtedness that may be incurred shall be limited to €95 million; and (ii) the Note Guarantees of the ONI Group together with their guarantees of obligations under the Revolving Credit Facilities, the Guarantee Facility, the Senior Credit Facilities, the Existing Senior Secured Notes, the New Senior Secured Notes, the Existing Senior Notes, certain Hedging Obligations and certain future Indebtedness that may be incurred shall be limited to €45.8 million. See “*Corporate and Financing Structure*”. None of HOT, Altice Blue Two SAS (“*NewCo OMT*”), ABO or any of their Subsidiaries will Guarantee the Notes.

Within 90 days after the Completion Date (if it occurs), the Notes will be Guaranteed by the Post-Completion Date Guarantors ; *provided that* (i) that the Note Guarantee of Target, together with its guarantee of obligations under the Revolving Credit Facilities, the Guarantee Facility, the Senior Credit Facilities, the Existing Senior Secured Notes, the New Senior Secured Notes, the Existing Senior Notes, certain Hedging Obligations and certain future Indebtedness that may be incurred shall be limited to €4,634.4 million; and (ii) the Note Guarantee of PT OpCo, together with its guarantee of obligations under the Revolving Credit Facilities, the Guarantee Facility, the Senior Credit Facilities, the Existing Senior Secured Notes, the New Senior Secured Notes, the Existing Senior Notes, certain Hedging Obligations and certain future Indebtedness that may be incurred shall be limited to €968.4 million. See “*Corporate and Financing Structure*”.

Although the Existing Senior Notes are guaranteed by ABO, because of applicable restrictions under French law related to corporate benefit, the Notes will not be guaranteed by ABO.

Each Note Guarantee of the Notes will:

- be a senior subordinated obligation of the relevant Guarantor;
- be subordinated in right of payment to all existing and future Senior Indebtedness of that Guarantor (including that Guarantors’ obligations under the Existing Senior Secured Notes, the New Senior Secured Notes, the Senior Credit Facilities, the Revolving Credit Facilities, the Guarantee Facility and certain Hedging Obligations);
- rank *pari passu* in right of payment with any existing and future Indebtedness of that Guarantor that is not subordinated in right of payment to such Guarantor’s Note Guarantee;
- rank senior in right of payment to any existing and future obligations of such Guarantor that is expressly subordinated in right of payment to such Note Guarantee;
- benefit from the security as set forth below under “—*Notes Security*”;
- be effectively subordinated to any existing and future secured Indebtedness of that Guarantor that are secured by Liens ranking ahead of the Liens securing the Notes or Note Guarantees or secured by property and assets that do not secure the Notes or Note Guarantees, to the extent of the value of the property and assets securing such Indebtedness (including the Existing Senior Secured Notes, the New Senior Secured Notes, any borrowings under the Senior Credit Facilities, the Revolving Credit Facilities, the Guarantee Facility and any secured Hedging Obligations); and
- be effectively subordinated to the Indebtedness and other obligations of Subsidiaries of Altice International that do not Guarantee the Notes.

Payment under the Guarantees will be expressly subordinated in right of payment to the payment when due of all Senior Indebtedness of the Guarantors (including Indebtedness Incurred under the Revolving Credit Facilities, the Senior Credit Facilities, the Senior Secured Notes, the Guarantee Facility and certain Hedging Obligations), the holders of which (or

their representatives) are party to the Intercreditor Agreement or any Additional Intercreditor Agreement. As a result of this subordination, holders of such Senior Indebtedness of any Guarantor will be entitled to receive full payment on all obligations owed to them before any payment can be made to Holders of the Notes in respect of the Guarantees.

Subordination of the Note Guarantees on the Basis of the Intercreditor Agreement

Each of the Note Guarantees is a senior subordinated Guarantee, which means that, pursuant to the terms of the Intercreditor Agreement, each such Note Guarantee ranks behind, and is expressly subordinated to, all the existing and future Senior Indebtedness of the relevant Guarantor, the holders of which (or their representatives) are party to the Intercreditor Agreement or any Additional Intercreditor Agreement, including any obligations owed by the relevant Guarantor under the Senior Credit Facilities, the Revolving Credit Facilities, the Senior Secured Notes, the Guarantee Facility and certain Hedging Obligations. The ability to take enforcement action against the Guarantors under their Note Guarantees is subject to significant restrictions imposed by the Intercreditor Agreement and the terms of the Note Guarantees, and potentially any Additional Intercreditor Agreements entered into after the Issue Date. For a description of the restrictions imposed by the Intercreditor Agreement, see “*Description of Other Indebtedness—Intercreditor Agreement.*”

Because of the foregoing subordination provisions, it is likely that holders of Senior Indebtedness and other creditors (including trade creditors) of a Guarantor would recover disproportionately more than the holders of the Notes recover in any insolvency or similar proceeding relating to such Guarantor. In any such case, there may be insufficient assets, or no assets, remaining to pay the principal of or interest on the Notes.

Further, the obligations of a Guarantor under its Note Guarantee will be limited as necessary to prevent the relevant Note Guarantee from constituting a fraudulent conveyance under applicable law, or otherwise to reflect limitations under applicable law or capital maintenance regulations. See “*Risk Factors—Risks Relating to the New Notes and the Structure—Each Guarantee will be subject to certain limitations on enforcement and may be limited by applicable laws or subject to certain defenses that may limit its validity and enforceability*” and “*Limitation on Validity and Enforceability of the Guarantees and the Security Interests*”.

As of September 30, 2014, on an as-adjusted consolidated basis after giving effect to the Transactions, including the issuance of the Notes, the New Senior Secured Notes and the amounts expected to be drawn under the Additional Revolving Credit Facilities to consummate the Acquisition, and the application of the proceeds therefrom as described under “Use of Proceeds” elsewhere in this Offering Memorandum, Altice International and its Restricted Subsidiaries would have had outstanding €7,425 million equivalent aggregate principal amount of Indebtedness if the Acquisition is consummated. As of September 30, 2014, on an as-adjusted basis after giving effect to the Transactions, including the issuance of the Notes and the application of the proceeds therefrom, the Issuer on a consolidated basis would have had €7,105 million equivalent aggregate principal amount of outstanding Indebtedness.

Each of Altice International, the Issuer, Altice Holdings S.à r.l., Altice West Europe S.à r.l., Altice Caribbean, NewCo OMT, Altice Portugal, Cool, H. Hadaros 2012, Ltd, the Target and certain other Guarantors is a holding company and does not conduct any operations and is wholly dependent on payments from its respective Subsidiaries to meet its obligations, including the Senior Secured Notes Issuer’s obligations under the Proceeds Loans and the Guarantors’ obligations under their Note Guarantees and their respective Finco Proceeds Loans.

Principal and Maturity

The Issuer issued \$385 million aggregate principal amount of Notes on the Issue Date. The Notes will mature on February 15, 2025 at which time 100% of the principal amount of the Notes shall be payable, unless redeemed prior thereto as described herein. The Notes will be issued in minimum denominations of \$200,000 and in integral multiples of \$1,000 in excess thereof.

Interest

Interest on the Notes will accrue at the rate of 7.625% per annum. Interest on the Notes will:

- accrue from the date of original issuance or, if interest has already been paid, from the date it was most recently paid;
- be payable in cash semi-annually in arrears on each April 1 and October 1, commencing on October 1, 2015;
- be payable to the holder of record of such Notes on March 15 and September 15 immediately preceding the related interest payment date; and

- be computed on the basis of a 360-day year comprised of twelve 30-day months.

Interest on overdue principal and interest, including Additional Amounts, if any, will accrue at a rate that is 1% higher than the interest rate on the Notes.

If the due date for any payment in respect of any Notes is not a Business Day at the place at which such payment is due to be paid, the Holder thereof will not be entitled to payment of the amount due until the next succeeding Business Day at such place, and will not be entitled to any further interest or other payment as a result of any such delay.

Methods of Receiving Payments on the Notes

Principal, interest and premium, if any, on the Global Notes (as defined below) will be payable at the specified office or agency of one or more Paying Agents; *provided* that all such payments with respect to Notes represented by one or more Global Notes registered in the name of or held by Common Depositary or its nominee will be made by wire transfer of immediately available funds to the account specified by the Holder or Holders thereof.

Principal, interest and premium, if any, on any certificated securities (“*Definitive Registered Notes*”) will be payable at the specified office or agency of one or more Paying Agents maintained for such purposes in London, United Kingdom and New York, New York. In addition, at the option of the Issuer, interest on the Definitive Registered Notes may be paid by check mailed to the Person entitled thereto as shown on the register for the Definitive Registered Notes. See “—*Paying Agent and Registrar for the Notes*”.

Paying Agent and Registrar for the Notes

The Issuer will maintain one or more paying agents for the Notes (each, a “Paying Agent” and, together the “Paying Agents”) in (i) the City of London, United Kingdom (the “Principal Paying Agent”) and (ii) New York, New York. The Issuer will also undertake to maintain a Paying Agent in a European Union member state that will not be obliged to withhold or deduct tax pursuant to the European Union Directive 2003/48/EC (as amended from time to time) or any other directive implementing the conclusions of the ECOFIN Council meeting of 26 and 27 November 2000 regarding the taxation of savings income (the “Directive”), or any law implementing or complying with or introduced in order to conform to such Directive. The Principal Paying Agent will be Deutsche Bank AG, London Branch in London and the U.S. Paying Agent will be Deutsche Bank Trust Company Americas in New York.

The Issuer will also maintain one or more registrars (each, a “Registrar”). The initial Registrar will be Deutsche Bank Trust Company Americas. The Issuer will also maintain a transfer agent. The initial transfer agent will be Deutsche Bank Trust Company Americas. The Registrar will maintain a register reflecting ownership of Definitive Registered Notes (as defined herein) outstanding from time to time, if any, and will facilitate transfers of Definitive Registered Notes on behalf of the Issuer. Each transfer agent shall perform the functions of a transfer agent. Each Registrar shall provide a copy of the register and any update thereof to the Issuer and the Issuer shall maintain a register of the Notes at its registered office in order to comply with Luxembourg law (the “Duplicate Register”). In case of discrepancy between any register and the Duplicate Register, the Duplicate Register shall prevail for Luxembourg law purposes.

The Issuer may change any Paying Agents, Registrars or transfer agents for the Notes without prior notice to the Holders of such Notes. However, for so long as Notes are listed on the Euro MTF Market of the Luxembourg Stock Exchange and the rules of the Luxembourg Stock Exchange so require, the Issuer will publish a notice of any change of Paying Agent, Registrar or transfer agent on the official website of the Luxembourg Stock Exchange (www.bourse.lu), to the extent and in the manner permitted by the rules and the regulations of the Luxembourg Stock Exchange. The Issuer or any of its Subsidiaries may act as Paying Agent or Registrar in respect of the Notes.

Transfer and Exchange

The Notes have been issued in the form of several registered notes in global form, without interest coupons, as follows:

- The Notes sold within the United States to qualified institutional buyers pursuant to Rule 144A under the Securities Act will initially be represented by a global note in registered form without interest coupons attached (the “144A Global Notes”).
- The 144A Global Notes were deposited with a custodian for The Depository Trust Company (“DTC”) and registered in the name of Cede & Co., as nominee of DTC on the Issue Date.

- The Notes sold outside the United States pursuant to Regulation S under the Securities Act will initially be represented by a global note in registered form without interest coupons attached (the “Regulation S Global Notes,” and together with the 144A Global Notes, the “Global Notes”).
- During the 40-day “distribution compliance period” (as such term is defined in Rule 902 of Regulation S under the Securities Act), the Regulation S Global Notes will initially be credited within DTC for the accounts of Euroclear Bank SA/NV (“Euroclear”) and Clearstream Banking, société anonyme (“Clearstream”). After the 40-day distribution compliance period ends, investors may also hold their interests in the permanent Regulation S Global Note through organizations other than Clearstream or Euroclear that are DTC participants.

During the 40-day distribution compliance period, book-entry interests in the Regulation S Global Note may be (1) held only through through DTC for the account of Euroclear and Clearstream, and (2) transferred only to non-U.S. persons under Regulation S or qualified institutional buyers under Rule 144A. Ownership of interests in the Global Notes (“Book-Entry Interests”) will be limited to persons that have accounts DTC, or persons that may hold interests through such participants. Ownership of interests in the Book-Entry Interests and transfers thereof will be subject to the restrictions on transfer and certification requirements summarized below and described more fully under “*Transfer Restrictions*”. In addition, transfers of Book-Entry Interests between participants in DTC will be effected by DTC, pursuant to customary procedures and subject to the applicable rules and procedures established by DTC and its participants.

Book-Entry Interests in the 144A Global Note may be transferred to a person who takes delivery in the form of Book-Entry Interests in the Regulation S Global Note only upon delivery by the transferor of a written certification (in the form provided in the indenture) to the effect that such transfer is being made in accordance with Regulation S under the Securities Act.

Regulation S Book-Entry Interests may be transferred to a person who takes delivery in the form of 144A Book-Entry Interests only upon delivery by the transferor of a written certification (in the form provided in the Indenture) to the effect that such transfer is being made to a person who the transferor reasonably believes is a “qualified institutional buyer” within the meaning of Rule 144A in a transaction meeting the requirements of Rule 144A or otherwise in accordance with the transfer restrictions described under “*Transfer Restrictions*” and in accordance with any applicable securities law of any other jurisdiction.

Any Book-Entry Interest that is transferred as described in the immediately preceding paragraphs will, upon transfer, cease to be a Book-Entry Interest in the Global Note from which it was transferred and will become a Book-Entry Interest in the Global Note to which it was transferred.

Accordingly, from and after such transfer, it will become subject to all transfer restrictions, if any, and other procedures applicable to Book-Entry Interests in the Global Note to which it was transferred.

If Definitive Registered Notes are issued, they will be issued only in minimum denominations of \$200,000 principal amount, as the case may be, and integral multiples of \$1,000 in excess thereof, upon receipt by the Registrar of instructions relating thereto and any certificates, opinions and other documentation required by the Indenture. It is expected that such instructions will be based upon directions received by DTC from the participant which owns the relevant Book-Entry Interests. Definitive Registered Notes issued in exchange for a Book-Entry Interest will, except as set forth in the Indenture or as otherwise determined by the Issuer to be in compliance with applicable law, be subject to, and will have a legend with respect to, the restrictions on transfer summarized below and described more fully under “*Transfer Restrictions*”.

Subject to the restrictions on transfer referred to above, Notes issued as Definitive Registered Notes may be transferred or exchanged, in whole or in part, in minimum denominations of \$200,000 in principal amount and integral multiples of \$1,000 in excess thereof. In connection with any such transfer or exchange, the Indenture requires the transferring or exchanging holder to, among other things, furnish appropriate endorsements and transfer documents, to furnish information regarding the account of the transferee at DTC to furnish certain certificates and opinions, and to pay any taxes, duties and governmental charges in connection with such transfer or exchange. Any such transfer or exchange will be made without charge to the holder, other than any taxes, duties and governmental charges payable in connection with such transfer.

Notwithstanding the foregoing, the Issuer is not required to register the transfer or exchange of any Notes:

- (1) for a period of 15 days prior to any date fixed for the redemption of the Notes;
- (2) for a period of 15 days immediately prior to the date fixed for selection of Notes to be redeemed in part;

- (3) for a period of 15 days prior to the record date with respect to any interest payment date; or
- (4) which the Holder has tendered (and not withdrawn) for repurchase in connection with a Change of Control Offer or an Asset Disposition Offer.

The Issuer, the Trustee, the Paying Agents, the transfer agents and the Registrar will be entitled to treat the registered holder of a Note as the owner of it for all purposes.

The Note Guarantees

General

The Notes have not been guaranteed as of the Issue Date. Although Altice International is a party to the Indenture on the Issue Date for the purposes of the covenants described below, Altice International's Note Guarantee will not be effective until the Completion Date occurs. Following the Completion Date, the Notes will be Guaranteed by the Completion Date Guarantors that grant a Note Guarantee on such date on a senior subordinated basis for the full and punctual payment when due, whether at Stated Maturity, by acceleration or otherwise, of all payment obligations of the Issuer under the Indenture and the Notes, whether for payment of principal of or interest on or in respect of the Notes, fees, expenses, indemnification or otherwise. The Note Guarantees of Cabovisao and Altice Portugal together with their guarantees of obligations under the Revolving Credit Facilities, the Guarantee Facility, the Senior Credit Facilities, the Existing Senior Secured Notes, the New Senior Secured Notes, the Existing Senior Notes, certain Hedging Obligations and certain future Indebtedness that may be incurred shall be limited to €95 million. The Note Guarantees of the ONI Group together with their guarantees of obligations under the Revolving Credit Facilities, the Guarantee Facility, the Senior Credit Facilities, the Existing Senior Secured Notes, the New Senior Secured Notes, the Existing Senior Notes, certain Hedging Obligations and certain future Indebtedness that may be incurred shall be limited to approximately €45.8 million.

Within 90 days after the Completion Date (if it occurs), the Notes will be guaranteed by the Post-Completion Date Guarantors. The Note Guarantee of Target, together with its guarantee of obligations under the Revolving Credit Facilities, the Guarantee Facility, the Senior Credit Facilities, the Existing Senior Secured Notes, the New Senior Secured Notes, the Existing Senior Notes, certain Hedging Obligations and certain future Indebtedness that may be incurred shall be limited to €4,634.4 million. The Note Guarantee of PT OpCo, together with its guarantee of obligations under the Revolving Credit Facilities, the Guarantee Facility, the Senior Credit Facilities, the Existing Senior Secured Notes, the New Senior Secured Notes, the Existing Senior Notes, certain Hedging Obligations and certain future Indebtedness that may be incurred shall be limited to €968.4 million.

On the Issue Date and the Completion Date, the Notes did not and will not benefit from a direct guarantee from HOT or any of its Subsidiaries, from NewCo OMT or any of its Subsidiaries, from ABO or any of its Subsidiaries, or from Coditel Holding or any of its Subsidiaries.

The obligations of each Guarantor under its Note Guarantee are or will be, as applicable, contractually limited under the applicable guarantees to reflect limitations under applicable law with respect to maintenance of share capital applicable to such Guarantor and its shareholders, directors and general partners. See "*Limitation on Validity and Enforceability of the Guarantees and the Security Interests*".

The Issuer is a special purpose finance vehicle formed for the purpose of serving as the issuer of the Existing Senior Notes and the Notes and does not conduct, and will be prohibited by the Indenture from engaging in, any operations. On the Completion Date, the Issuer's only assets will be the shares it holds in the Senior Secured Notes Issuer and the Proceeds Loans made on December 27, 2012; July 2, 2013; March 12, 2014; April 9, 2014; and the Completion Date (if it occurs). As a result, the Issuer is wholly dependent on payments from the Senior Secured Notes Issuer, including payments made by the Senior Secured Notes Issuer under the Proceeds Loans, to fund its obligations under the Notes.

The Senior Secured Notes Issuer is a special purpose finance vehicle formed for the purpose of serving as the issuer of the Senior Secured Notes and does not conduct, and is prohibited by the Indenture and the indenture governing the Senior Secured Notes from engaging in, any operations. Upon completion of the Transactions, the Senior Secured Notes Issuer's only assets will be the Finco Proceeds Loans made on December 27, 2012; July 2, 2013; July 5, 2013; August 8, 2013; March 12, 2014; April 9, 2014; and the Completion Date (if it occurs); and (ii) cash in its bank accounts. As a result, the Senior Secured Notes Issuer is wholly dependent on payments from Altice International and its Subsidiaries including payments made by the borrowers under the Finco Proceeds Loans, to fund its obligations under the Senior Secured Notes and the loans under the Senior Credit Facilities to the extent it does not otherwise have funds available to it.

The operations of each of Altice International and each of the other Guarantors that are holding companies are conducted through their respective Subsidiaries and, therefore, each of Altice International and such other Guarantors depend on the cash flow of such Subsidiaries to meet its obligations, including its obligations under its Note Guarantee and the proceeds

loan that has been Incurred by it. See “*Risk Factors—Risks Relating to the New Notes and the Structure—Altice International and most of the other Senior Notes Guarantors are holding companies and conducts no business of their own and will depend on payments from their direct and indirect subsidiaries to provide them with funds to meet their obligations under the Senior Note Guarantees.*”

Additional Note Guarantees

Altice International may from time to time designate a Restricted Subsidiary as an additional guarantor of the Notes (the “*Additional Guarantors*”) by causing it to execute and deliver to the Trustee a supplemental indenture in the form attached to the Indenture (and with such documentation relating thereto as the Trustee may reasonably require, including Opinions of Counsel as to the enforceability of such Note Guarantee), pursuant to which such Restricted Subsidiary will become a Guarantor.

Each Additional Guarantor will, jointly and severally, with the Guarantors and each other Additional Guarantor, irrevocably guarantee (each guarantee, an “*Additional Guarantee*”) on a senior subordinated basis the full and punctual payment when due, whether at Stated Maturity, by acceleration or otherwise, of all payment obligations of the Issuer under the Indenture and the Notes, whether for payment of principal of or interest on or in respect of the Notes, fees, expenses, indemnification or otherwise. The obligations of any Additional Guarantor will be contractually limited under its Additional Guarantee to reflect limitations under applicable law, including, among other things, with respect to maintenance of share capital applicable to such Additional Guarantor and its shareholders, directors and general partner. Subject to the foregoing, any Additional Guarantee issued by a Restricted Subsidiary shall be issued on substantially the same terms as the Note Guarantees of the Restricted Subsidiaries that will become Guarantors on the Completion Date. For purposes of the Indenture and this “*Description of Senior Notes*”, references to the Note Guarantees include references to any Additional Guarantees and references to the Guarantors include references to any Additional Guarantors.

Releases of the Note Guarantees

The Note Guarantee of Altice International may be released:

- upon legal defeasance, covenant defeasance or satisfaction and discharge of the Indenture, as provided in “*—Defeasance*” and “*—Satisfaction and Discharge*”;
- in accordance with the Intercreditor Agreement or any Additional Intercreditor Agreement;
- as described under “*—Amendments and Waivers*”;
- if Altice International is not the continuing or surviving Person in the relevant consolidation or merger, as a result of a transaction that complies with the provisions described under “*—Merger and Consolidation—Altice International*”; or
- upon the full and final payment and performance of all obligations of the Issuer under the Indenture and the Notes.

The Note Guarantee of a Subsidiary Guarantor will terminate:

- upon a sale or other disposition (including by way of consolidation, merger, amalgamation or combination) of the Capital Stock of the relevant Subsidiary Guarantor (whether by direct sale or sale of a holding company of such Subsidiary Guarantor) or the sale or disposition of all or substantially all the assets of the Subsidiary Guarantor (other than to Altice International or a Restricted Subsidiary), in each case if the sale or other disposition does not violate the covenant described under “*—Certain Covenants—Limitation on Sales of Assets and Subsidiary Stock*”;
- upon the designation in accordance with the Indenture of that Subsidiary Guarantor as an Unrestricted Subsidiary;
- upon legal defeasance, covenant defeasance or satisfaction and discharge of the Indenture, as provided in “*—Defeasance*” and “*—Satisfaction and Discharge*”;
- in accordance with the Intercreditor Agreement or any Additional Intercreditor Agreement;
- as described under “*—Amendments and Waivers*”;
- as described under “*—Certain Covenants—Additional Guarantors*”;

- with respect to any Subsidiary Guarantor that is not the continuing or surviving Person in the relevant consolidation or merger, as a result of a transaction that complies with the provisions described under “—*Merger and Consolidation—The Subsidiary Guarantors*”; or
- upon the full and final payment and performance of all obligations of the Issuer under the Indenture and the Notes.

The Trustee and the Security Agent (as applicable) shall each take all necessary actions, including the granting of releases or waivers under the Intercreditor Agreement or any Additional Intercreditor Agreement, to effectuate any release of a Note Guarantee in accordance with these provisions, subject to customary protections and indemnifications. Each of the releases set forth above shall be effective without the consent of the Holders or any action on the part of the Trustee. Neither the Trustee nor the Issuer will be required to make a notation on the Notes to reflect any such release, termination or discharge.

Notes Security

General

As of the Issue Date, the Notes were secured only by a security interest in the Escrowed Property. On the Completion Date, the Notes will be secured by:

- security interests granted on a first-priority basis over all of the Capital Stock of the Issuer (the “Issuer Share Pledge”);
- a second-priority security interest over the Proceeds Loans made on December 27, 2012, July 2, 2013, March 12, 2014, April 9, 2014 and on the Completion Date;
- a second-priority security interest over all of the Capital Stock of the Senior Secured Notes Issuer, Cool and Altice Holding; and
- a second-priority security interest in the Subordinated Shareholder Loan,

collectively, the “*Notes Collateral*.”

The Notes Collateral will also secure the Existing Senior Notes and (other than the Issuer Share Pledge) will also secure Indebtedness under the Revolving Credit Facilities, the Senior Secured Notes, the Senior Credit Facilities, the Guarantee Facility and certain Hedging Obligations. The pledge agreements and the other security documents in respect of the Notes Collateral entered into on December 27, 2012; July 2, 2013; July 5, 2013; August 8, 2013; March 12, 2014; April 9, 2014; and to be entered into on the Completion Date (or any other date on which security interests in the Notes Collateral were granted in connection with existing Indebtedness) in respect of the Notes Collateral are referred to as the “Security Documents”. Any other additional security interests that may in the future be granted to secure the obligations under the Notes, the Note Guarantees and the Indenture would also constitute Notes Collateral.

Subject to certain conditions, including compliance with the covenants described under “—*Certain Covenants—Limitation on Liens*” and “—*Certain Covenants—Impairment of Security Interests*”, Altice International and its Restricted Subsidiaries are permitted to incur certain additional Indebtedness in the future that may be secured on the Notes Collateral, including any Additional Notes, additional Senior Secured Notes, certain Indebtedness under Credit Facilities and certain other Hedging Obligations, in each case, permitted under the Indenture.

The proceeds from the sale of the Notes Collateral remaining after sharing with other creditors entitled to share in such proceeds may not be sufficient to satisfy the obligations owed to the Holders of the Notes. No appraisals of the Notes Collateral have been made in connection with this offering of Notes. By its nature, some or all of the Notes Collateral will be illiquid and may have no readily ascertainable market value. Accordingly, the Notes Collateral may not be able to be sold in a short period of time, or at all. In addition, the Holders of the Notes will be subject to certain standstill provisions on enforcement of the Notes Collateral (other than the Issuer Share Pledge) pursuant to the Intercreditor Agreement. Furthermore, the Intercreditor Agreement places limitations on the ability of the Security Agent to release the security interests in some of the Notes Collateral, by reference to the interests of other creditors. These limitations may include requirements that some or all of the Notes Collateral be disposed of only pursuant to public auctions or only at a price confirmed by a valuation. See “*Description of Other Indebtedness—The Intercreditor Agreement*” and “*Risk Factors—Risks Relating to the New Notes and the Structure—The value of the Collateral may not be sufficient to satisfy our obligations under the New Notes and such Collateral may be reduced or diluted under certain circumstances which may be time consuming and cumbersome*” and certain Collateral and Guarantees will be limited to a specified maximum amount.

The creditors under the Existing Senior Notes, the Senior Secured Notes, the Revolving Credit Facilities, the Senior Credit Facilities, the Guarantee Facility, the counterparties to the Hedging Obligations secured by the Notes Collateral and the Trustee have and/or will have, and by accepting a Note, each holder will be deemed to have, irrevocably appointed the Security Agent to act as its agent and security agent under the Intercreditor Agreement and the Security Documents. The creditors under the Existing Senior Notes, the Revolving Credit Facilities, the Senior Credit Facilities, the Guarantee Facility, the counterparties to the Hedging Obligations secured by the Notes Collateral and the Trustee have and/or will have, and by accepting a Note, each holder will be deemed to have, irrevocably authorized the Security Agent to (i) perform the duties and exercise the rights, powers and discretions that are specifically given to it under the Intercreditor Agreement or the Security Documents, together with any other incidental rights, power and discretions; and (ii) execute each Security Document, waiver, modification, amendment, renewal or replacement expressed to be executed by the Security Agent on its behalf.

Security Documents

Under the Security Documents, the Issuer and Altice International have granted or will grant security over the Notes Collateral to secure the payment when due of the Issuer's and the Guarantors' payment obligations under the Notes, the Note Guarantees and the Indenture. The existing Security Documents have been, and the Security Documents to be entered into on the Completion Date will be, entered into by the relevant security provider and the Security Agent as agent for the secured parties referred to therein. When entering into the Security Documents, the Security Agent has acted and will act in its own name, but also as a representative of the secured parties (including the Holders from time to time). Under the Intercreditor Agreement, the Security Agent will also act on behalf of the holders of the Existing Senior Notes and the Senior Secured Notes, the lenders under the Revolving Credit Facilities, the Senior Credit Facilities, and the Guarantee Facility, the counterparties under certain Hedging Obligations, and holders of any additional Indebtedness that is permitted to be secured by the Notes Collateral in favor of such parties.

The Indenture provides that, subject to the terms thereof and of the Security Documents and the Intercreditor Agreement, the Notes and the Note Guarantees, as applicable, will be secured by the security interest in the Notes Collateral that is created by the Security Documents and secures obligations under the Notes or the Note Guarantees and the Indenture (the "*Security Interests*"). Such Security Interests in the Notes Collateral also secure the obligations under the Existing Senior Notes and (other than the Issuer Share Pledge) also secure the obligations under the Senior Secured Notes, the Revolving Credit Facilities, the Senior Credit Facilities, the Guarantee Facility and certain Hedging Obligations and will secure certain other Indebtedness permitted by the Indenture to be Incurred in the future and secured by such Notes Collateral. The Issuer Share Pledge will also secure certain other Indebtedness permitted by the Indenture to be Incurred in the future and secured by the Issuer Share Pledge. However, the Security Interests may be released under certain circumstances as provided under "*—Release of Note Collateral*" below. See "*Risk Factors—Risks Related to the New Notes and the Structure—There are circumstances other than repayment or discharge of the New Notes under which the Collateral and the Guarantees will be released automatically, without your consent or the consent of the Trustee*".

The Security Documents provide that the rights with respect to the Notes and the Note Guarantees must be exercised by the Security Agent. Because the Holders will not be a party to the Security Documents, Holders may not, individually or collectively, take any direct action to enforce any rights in their favor under the Security Documents. The Holders may only act through the Security Agent.

In the event that the Issuer or other grantor of a security interest in the Notes Collateral enters into insolvency, bankruptcy or similar proceedings, the Security Interests created under the Security Documents or the rights and obligations enumerated in the Intercreditor Agreement could be subject to potential challenges. If any challenge to the validity of the Security Interests or the terms of the Intercreditor Agreement were successful, the Holders might not be able to recover any amounts under the Security Documents. See "*Risk Factors—Risks Relating to the New Notes and the Structure—Each Guarantee will be subject to certain limitations on enforcement and may be limited by applicable laws or subject to certain defenses that may limit its validity and enforceability*" and "*Limitation on Validity and Enforceability of the Guarantees and the Security Interests*".

Release of Notes Collateral

The Issuer and the Guarantors will be entitled to release the Security Interests in respect of the Notes Collateral securing the Notes and the Note Guarantees under any one or more of the following circumstances:

- (1) in connection with any sale or other disposition of the Notes Collateral (other than the Issuer Share Pledge) to a Person that is not Altice International or a Restricted Subsidiary (but excluding any transaction subject to "*—Certain Covenants—Merger and Consolidation*"), if such sale or other disposition does not violate the covenant described under "*—Certain Covenants—Limitation on Sales of Assets and Subsidiary Stock*", but only in respect of the Notes Collateral sold or otherwise disposed of;

- (2) in connection with the release of a Guarantor from its Note Guarantee pursuant to the terms of the Indenture, the release of the property and assets, and Capital Stock, of such Guarantor;
- (3) if Altice International designates any Restricted Subsidiary to be an Unrestricted Subsidiary in accordance with the applicable provisions of the Indenture, the release of the property, assets and Capital Stock of such Unrestricted Subsidiary;
- (4) upon legal defeasance, covenant defeasance or satisfaction and discharge of the Indenture, as provided in “—*Defeasance*” and “—*Satisfaction and Discharge*”;
- (5) in accordance with the Intercreditor Agreement or any Additional Intercreditor Agreement (see “*Description of Other Indebtedness—The Intercreditor Agreement—Restrictions on Enforcement*”);
- (6) as described under “—*Amendments and Waivers*”, “—*Certain Covenants—Impairment of Security Interests*” and the second paragraph under “—*Certain Covenants—Limitation on Liens*”;
- (7) upon the full and final payment and performance of all obligations of the Issuer under the Indenture and the Notes;
- (8) to release and re-take any Lien on any Notes Collateral to the extent not otherwise prohibited by the terms of the Indenture, the Security Documents or the Intercreditor Agreement or any Additional Intercreditor Agreement;
- (9) in connection with a transaction permitted by the covenant described below under the caption “—*Certain Covenants—Merger and Consolidation*”; or
- (10) with the consent of holders of at least 75% in aggregate principal amount of Notes (including, without limitation, consent obtained in connection with a tender offer or exchange offer for, or purchase of, the Notes);

provided that, the Security Interests created by the Escrow Assignments may only be released upon release of all of the Escrowed Property from the Escrow Account in accordance with the terms of the Notes Escrow Agreement.

Upon certification by the Issuer, the Trustee (to the extent action is required by it) and the Security Agent shall take all necessary actions, including the granting of releases or waivers under the Intercreditor Agreement, to effectuate any release in accordance with these provisions, subject to customary protections and indemnifications. The Security Agent and the Trustee (as applicable) will take all necessary action required to effectuate any release of the Notes Collateral, in accordance with the provisions of the Indenture, the Intercreditor Agreement or any Additional Intercreditor Agreement and the relevant Security Document. Each of the releases set forth above shall be effected by the Security Agent without the consent of the Holders or any action on the part of the Trustee.

The Proceeds Loans

On December 27, 2012, the Issuer made a loan to the Senior Secured Notes Issuer, pursuant to a proceeds loan in aggregate principal amount of \$425 million (the “*Initial Proceeds Loan*”). The Initial Proceeds Loan is subordinated to the Obligations of the Issuer under the Senior Secured Notes, the Revolving Credit Facilities, the Senior Credit Facilities, the Guarantee Facility and its Hedging Obligations.

On July 2, 2013, the Issuer made a loan to the Senior Secured Notes Issuer, pursuant to a proceeds loan in aggregate principal amount of €250 million (the “*July Proceeds Loan*”).

On March 9, 2014, the Issuer made a loan to the Senior Secured Notes Issuer, pursuant to a proceeds loan in aggregate principal amount of €400 million (the “*March Proceeds Loan*”).

On April 12, 2014, the Issuer made loans to the Senior Secured Notes Issuer, pursuant to proceeds loans in aggregate principal amount of €300 million and €900 million (together, the “*April Proceeds Loans*”).

On the Completion Date, the Issuer will make a loan to the Senior Secured Notes Issuer, pursuant to a proceeds loan in aggregate principal amount of €340 million (equivalent) (the “*Additional Proceeds Loan*” and, collectively with the Initial Proceeds Loan, the July Proceeds Loan, the March Proceeds Loan and the April Proceeds Loans, the “*Proceeds Loans*”). The Additional Proceeds Loan will be subordinated to the Obligations of the Issuer under the Senior Secured Notes, the Revolving Credit Facilities, the Senior Credit Facilities, the Guarantee Facility and certain Hedging Obligations.

The Initial Proceeds Loan, the July Proceeds Loan, the March Proceeds Loans and the April Proceeds Loans have been, and the Additional Proceeds Loan will be, assigned as Notes Collateral to secure the Obligations of the Issuer and the Guarantors under the Notes and the Note Guarantees on a junior basis and to secure the Obligations of the Senior Secured Notes Issuer under the Senior Secured Notes, the Revolving Credit Facilities, the Senior Credit Facilities, the Guarantee Facility and its Hedging Obligations on a senior basis.

Intercreditor Agreement

The relative priority among (a) the lenders under the Revolving Credit Facilities, (b) the lenders under the Guarantee Facility, (c) the lenders under the Senior Credit Facilities, (d) the counterparties under certain Hedging Obligations secured on the Notes Collateral, (e) the holders of the Senior Secured Notes, (f) the holders of the Existing Senior Notes and (g) the Trustee and the Holders of the Notes under the Indenture with respect to the Security Interests in the Notes Collateral is established by the terms of the Intercreditor Agreement, the Indenture, the Security Documents, and the security documents relating to the Revolving Credit Facilities, the Senior Credit Facilities, such Hedging Obligations, the Guarantee Facility, the Senior Secured Notes and the Existing Senior Notes which provide, among other things, that:

- (i) the obligations under the Senior Secured Notes, the Revolving Credit Facilities, the Senior Credit Facilities, the Guarantee Facility and certain Hedging Obligations are secured equally and ratably by a first-priority interest in the Notes Collateral; *provided* that any liabilities in respect of obligations under the Revolving Credit Facilities and such Hedging Obligations will receive priority with respect to any proceeds received from any enforcement of the security over any Notes Collateral and certain distressed disposals of the Notes Collateral; and
- (ii) the obligations under the Notes and the Note Guarantees, the Existing Senior Notes and guarantees thereof will be secured by second-priority interests in the Notes Collateral (other than the Issuer Share Pledge).

The Issuer Share Pledge will only secure the obligations under the Notes, the Note Guarantees and certain other Pari Passu Indebtedness that is permitted to be secured thereby including the Existing Senior Notes and guarantees thereof.

The Indenture and the Intercreditor Agreement restrict the ability of the Holders of the Notes or the Trustee to instruct the Security Agent to enforce the security interests over the Notes Collateral (other than the Issuer Share Pledge) and provide for the release of the Security Interests in certain circumstances upon enforcement by the lenders under the Revolving Credit Facilities, the lenders under the Guarantee Facility, the lenders under the Senior Credit Facilities or the holders of our other senior secured debt, including the Senior Secured Notes. In general, the rights of the security agent under the Intercreditor Agreement (acting on its own behalf or on behalf of the Holders) to take enforcement action under the Security Documents (other than the Issuer Share Pledge) with respect to the Notes Collateral are subject to certain standstill provisions similar to those that apply to the Note Guarantees and other limitations on enforcement.

Please see the section entitled “*Description of Other Indebtedness—The Intercreditor Agreement*”. In addition, in connection with the Incurrence of certain Indebtedness that is permitted by the Indenture to be secured on the Collateral, the Issuer will enter into Additional Intercreditor Agreements in compliance with the Indenture on substantially the same terms as the Intercreditor Agreement. See “—*Certain Covenants—Impairment of Security Interest*” and “—*Additional Intercreditor Agreements; Agreement to Be Bound*”.

Additional Intercreditor Agreements; Agreement to Be Bound

Similar provisions to those described above may be included in any Additional Intercreditor Agreement (as defined below) entered into in compliance with the covenant described under “—*Certain Covenants—Additional Intercreditor Agreements*”.

The Indenture also provides that each Holder, by accepting a Note, shall be deemed to have agreed to and accepted the terms and conditions of the Intercreditor Agreement and any Additional Intercreditor Agreement and to have authorized the Trustee and the Security Agent to enter into any such Intercreditor Agreement or any such Additional Intercreditor Agreement.

Restricted Subsidiaries and Unrestricted Subsidiaries

As of the Issue Date, all of Altice International’s Subsidiaries other than Green Datacenter and Auberimmo SAS were Restricted Subsidiaries. In addition, in the circumstances described below under “—*Certain Definitions—Unrestricted Subsidiary*”, Altice International will be permitted to designate Restricted Subsidiaries as Unrestricted Subsidiaries. Unrestricted Subsidiaries will not be subject to many of the restrictive covenants in the Indenture.

Escrow of Proceeds; Special Mandatory Redemption

Concurrently with the closing of the offering of the Notes on the Issue Date, the Issuer entered into the Notes Escrow Agreement with the Trustee and the Escrow Agent, pursuant to which the initial purchasers deposited with the Escrow Agent an amount equal to the gross proceeds of this offering of the Notes into the Escrow Account. The initial funds deposited in the Escrow Account, and all other funds, securities, interest, dividends, distributions and other property and payments credited to the Escrow Account (less any property and/or funds paid in accordance with the Notes Escrow Agreement) are referred to, collectively, as the “*Escrowed Property*”. The Escrowed Property is controlled by the Escrow Agent, and pledged on a first ranking basis in favor of the Trustee on behalf of the holders of the Notes.

Pursuant to the Notes Escrow Agreement, the Issuer will be entitled to instruct the Escrow Agent to release some or all of the cash in the Escrow Accounts to invest such cash in certain permitted investments including in cash and/or any highly-rated stable net asset value money market fund. The Notes Escrow Agreement will require that all proceeds of such investments be deposited back into the relevant Escrow Account when such investments are sold, liquidated or otherwise returned.

In order to cause the Escrow Agent to release any Escrowed Property to the Issuer for purposes of completing the PT Portugal Acquisition (any such release, the “*Release*”), the Escrow Agent and the Trustee shall have received from the Issuer, on or before the Escrow Longstop Date, an officer’s certificate, in the form attached to the Notes Escrow Agreement:

- (i) (A) the Acquisition Agreement shall not have been modified, amended or waived in any respect that is material and adverse to the holders of the Notes without the prior consent of the Holders of a majority of the outstanding Notes (it being understood and agreed that any increase or reduction in the purchase price shall not be deemed to be materially adverse to the Holders of the Notes; *provided* that any increase in the purchase price shall not be funded by indebtedness of Altice International or any of its subsidiaries (including the PT Portugal Group)); and (B) the Acquisition Agreement remains in full force and effect; and
- (ii) as of the Completion Date, there are no events of bankruptcy, insolvency or court protection with respect to the Issuer or Altice International;

provided that the release will occur promptly upon the satisfaction of the applicable conditions set forth above. Upon such release, the Escrowed Property will be paid out in accordance with the Notes Escrow Agreement and each Escrow Account will be reduced to zero.;

In the event that (a) the Completion Date does not take place on or prior to the Escrow Longstop Date; (b) the Acquisition Agreement is terminated at any time prior to the Escrow Longstop Date; or (c) there is an event of bankruptcy, insolvency or court protection with respect to the Issuer on or prior to the Escrow Longstop Date (the date of any such event being the “*Special Termination Date*”), the Issuer will redeem all of the Notes (the “*Special Mandatory Redemption*”) at a price (the “*Special Mandatory Redemption Price*”) equal to 100% of the initial issue price of such Notes, plus accrued but unpaid interest and Additional Amounts, if any, from the Issue Date to the Special Mandatory Redemption Date (as defined below and subject to the right of holders of record on the relevant record date to receive interest due on the relevant interest payment date).

Notice of the Special Mandatory Redemption will be delivered by the Issuer, no later than one Business Day following the Special Termination Date, to the Trustee and the Escrow Agent, and will provide that the Notes shall be redeemed on a date that is no later than the fifth Business Day after such notice is given by the Issuer in accordance with the terms of the Notes Escrow Agreement (the “*Special Mandatory Redemption Date*”). On or before the Special Mandatory Redemption Date, the Escrow Agent shall pay to the Principal Paying Agent under the Indenture for payment to each holder of Notes to be redeemed the Special Mandatory Redemption Price for such holder’s Notes and, concurrently with the payment to such holders, shall deliver any excess Escrowed Property (if any) to the Issuer.

On the Issue Date, Altice International entered into a guarantee agreement pursuant to which it guarantees the Issuer’s obligations under the Notes in the event the Special Mandatory Redemption Price payable upon any Special Mandatory Redemption Price exceeds the amount of the Escrowed Property.

To secure the payment of the Special Mandatory Redemption Price, the Trustee granted, for the benefit of the holders of the Notes, security interests in the Escrow Account and the rights of the Issuer under the Notes Escrow Agreement (the “*Escrow Assignments*”).

If at the time of the Special Mandatory Redemption, the Notes are listed on the Luxembourg Stock Exchange and the rules of the Luxembourg Stock Exchange so require, the Issuer will notify the Luxembourg Stock Exchange that the Special Mandatory Redemption has occurred and any relevant details relating to such special mandatory redemption.

Optional Redemption

Except as described below and except as described under “*Redemption for Changes in Withholding Taxes*”, and “*Escrow of Proceeds, Special Mandatory Redemption*”, the Notes are not redeemable until February 15, 2020. On and after February 15, 2020 the Issuer may redeem all or, from time to time, part of the Notes upon not less than 30 nor more than 60 days’ notice, at the following redemption prices (expressed as a percentage of the principal amount) plus accrued and unpaid interest and Additional Amounts (as defined below), if any, to, but not including, the applicable redemption date (subject to the right of the Holders of record on the relevant record date to receive interest due on the relevant interest payment date), if redeemed during the twelve-month period beginning on February 15 of the years indicated below:

<u>Year</u>	<u>Redemption Price</u>
2020	103.813%
2021	102.542%
2022	101.271%
2023 and thereafter	100.000%

Unless the Issuer defaults in the payment of the redemption price, interest will cease to accrue on the Notes or the portion thereof called for redemption on the applicable redemption date. Any such redemption and notice may, in the Issuer’s discretion, be subject to the satisfaction of one or more conditions precedent.

Prior to February 15, 2018, the Issuer may on any one or more occasions redeem up to 40% of the original principal amount of the Notes (including the principal amount of any Additional Notes, upon not less than 30 nor more than 60 days’ notice, with funds in an aggregate amount (the “Redemption Amount”) not exceeding the Net Cash Proceeds of one or more Equity Offerings at a redemption price of 107.625% of the principal amount thereof, plus accrued and unpaid interest and Additional Amounts, if any, to, but not including, the applicable redemption date (subject to the right of Holders of record on the relevant record date to receive interest due on the relevant interest payment date); *provided* that:

- (1) at least 60% of the original principal amount of the Notes (including the principal amount of any Additional Notes) remains outstanding after each such redemption; and
- (2) the redemption occurs within 180 days after the closing of such Equity Offering.

Any redemption notice given in respect of the redemption referred to in the preceding paragraph may be given prior to completion of the related Equity Offering, and any such redemption or notice may, at the Issuer’s discretion, be subject to the satisfaction of one or more conditions precedent, including the completion of the related Equity Offering.

In addition, prior to February 15, 2020, the Issuer may redeem all or, from time to time, a part of the Notes upon not less than 30 nor more than 60 days’ notice at a redemption price equal to 100% of the principal amount thereof plus the Applicable Premium and accrued and unpaid interest and Additional Amounts, if any, to, but not including, the applicable redemption date (subject to the right of Holders of record on the relevant record date to receive interest due on the relevant interest payment date). Any such redemption and notice may, at the Issuer’s discretion, be subject to the satisfaction of one or more conditions precedent.

If the Issuer effects an optional redemption of Notes, it will, for so long as the Notes are listed on the Euro MTF Market of the Luxembourg Stock Exchange and the rules of the Luxembourg Stock Exchange so require, inform the Luxembourg Stock Exchange of such optional redemption and confirm the aggregate principal amount of the Notes that will remain outstanding immediately after such redemption.

Sinking Fund

Except as described under “*Escrow of Proceeds; Special Mandatory Redemption*”, the Issuer will not be required to make mandatory redemption payments or sinking fund payments with respect to the Notes.

Selection and Notice

If less than all of the Notes are to be redeemed at any time, the Notes for redemption will be selected in accordance with the procedures of DTC, or if DTC prescribes no method of selection, the Issuer will instruct the Trustee or the Registrar to select the Notes for redemption in compliance with the requirements of the principal securities exchange, if any, on which the Notes are listed, as certified to the Trustee or the Registrar or if the Notes are not so listed or such exchange prescribes no method of selection, then based on a method that most nearly approximates a *pro rata* selection or by lot; *provided, however*, that no Note of \$200,000 in aggregate principal amount or less shall be redeemed in part and only

Notes in integral multiples of \$1,000 will be redeemed. Neither the Trustee nor the Registrar will be liable for any selections made by it or DTC in accordance with this paragraph.

For so long as the Notes are listed on the Euro MTF Market of the Luxembourg Stock Exchange, not less than 30 nor more than 60 days prior to the redemption date, the Issuer will (if such Notes are in certificated form) mail notice of redemption to Holders by first-class mail, postage prepaid, at their respective addresses as they appear on the registration books of the Registrar. If such Notes are in global form, notice of redemption will be delivered to DTC, for communication to the entitled account holder. Such notice of redemption may also be posted on the official website of the Luxembourg Stock Exchange (www.bourse.lu), to the extent and in the manner permitted by the rules of the Luxembourg Stock Exchange.

If any Note is to be redeemed in part only, the notice of redemption that relates to that Note shall state the portion of the principal amount thereof to be redeemed. In the case of a Definitive Registered Note, a new Definitive Registered Note in principal amount equal to the unredeemed portion of any Definitive Registered Note redeemed in part will be issued in the name of the Holder thereof upon cancellation of the original Definitive Registered Note. In the case of a Global Note, an appropriate notation will be made on such Note to decrease the principal amount thereof to an amount equal to the unredeemed portion thereof. Subject to the terms of the applicable redemption notice, Notes called for redemption become due on the date fixed for redemption. On and after the redemption date, interest ceases to accrue on Notes or portions of Notes called for redemption.

Redemption for Changes in Withholding Taxes

The Issuer may redeem the Notes, in whole but not in part, at its discretion at any time upon giving not less than 30 nor more than 60 days' prior notice to the holders of the Notes (which notice will be irrevocable and given in accordance with the procedures described in "*—Selection and Notice*"), at a redemption price equal to 100% of the aggregate principal amount thereof, together with accrued and unpaid interest, if any, to the date fixed by the Issuer for redemption (a "Tax Redemption Date") and all Additional Amounts (if any) then due and which will become due on the Tax Redemption Date as a result of the redemption or otherwise (subject to the right of holders of the Notes on the relevant record date to receive interest due on the relevant interest payment date and Additional Amounts (if any) in respect thereof), if on the next date on which any amount would be payable in respect of the Notes, the Issuer or any Guarantor is or would be required to pay Additional Amounts, and (a) the Issuer or the relevant Guarantor cannot avoid such requirement by taking reasonable measures available to it (including the designation of a different Paying Agent), (b) in the case of a Guarantor, such amounts cannot be paid by the Issuer or any other Guarantor who in turn can pay such amounts without the obligation to pay Additional Amounts and (c) the requirement arises as a result of:

- (1) any amendment to, or change in, the laws or treaties (or any regulations or rulings promulgated thereunder) of a relevant Tax Jurisdiction (as defined in "*—Withholding Taxes*" below) which change or amendment is announced and becomes effective on or after the Issue Date (or, if the applicable Tax Jurisdiction became a Tax Jurisdiction on a date after the Issue Date, such later date); or
- (2) any amendment to, or change in, an official written interpretation or application of such laws, treaties, regulations or rulings (including by virtue of a holding, judgment or order by a court of competent jurisdiction or a change in published administrative practice) which amendment or change is announced and becomes effective on or after the Issue Date (or, if the applicable Tax Jurisdiction became a Tax Jurisdiction on a date after the Issue Date, such later date).

The Issuer will not give any such notice of redemption earlier than 60 days prior to the earliest date on which the Issuer or the relevant Guarantor would be obligated to make such payment or withholding if a payment in respect of the Notes was then due, and the obligation to pay Additional Amounts must be in effect at the time such notice is given. Prior to the publication or, where relevant, mailing of any notice of redemption of the Notes pursuant to the foregoing, the Issuer will deliver to the Trustee an opinion of independent tax counsel to the effect that there has been such amendment or change which would entitle the Issuer to redeem the Notes hereunder. In addition, before the Issuer publishes or mails notice of redemption of the Notes as described above, it will deliver to the Trustee an Officer's Certificate to the effect that (a) it or the relevant Guarantor cannot avoid its obligation to pay Additional Amounts by the Issuer or the relevant Guarantor taking reasonable measures available to it and (b) in the case of a Guarantor, the amounts giving rise to such obligation cannot be paid by the Issuer or any other Guarantor without the obligation to pay Additional Amounts.

The Trustee will accept and shall be entitled to conclusively rely without further inquiry on such Officer's Certificate and opinion of counsel as sufficient evidence of the existence and satisfaction of the conditions precedent as described above, in which event it will be conclusive and binding on the holders of the Notes.

For the avoidance of doubt, the implementation of European Council Directive 2003/48/EC or any other directive implementing the conclusions of the ECOFIN Council meeting of 26 and 27 November 2000 on the taxation of savings

income or any law implementing or complying with or introduced in order to conform to, such directive will not be a change or amendment for such purposes.

The foregoing will apply *mutatis mutandis* to any jurisdiction in which any successor Person to the Issuer is incorporated or organized, engaged in business or resident for tax purposes or any jurisdiction from or through which payment is made by or on behalf of such Person on the Notes and any political subdivision thereof or therein.

Withholding Taxes

All payments made under or with respect to the Notes or any Note Guarantee will be made free and clear of and without withholding or deduction for, or on account of, any present or future tax, duty, levy, assessment or other governmental charge, including any related interest, penalties or additions to tax (“Taxes”) unless the withholding or deduction of such Taxes is then required by law or by the official interpretation or administration thereof. If any deduction or withholding for, or on account of, any Taxes imposed or levied by or on behalf of (1) any jurisdiction in which the Issuer or any Guarantor is then incorporated or organized, engaged in business for tax purposes or resident for tax purposes or any political subdivision or governmental authority thereof or therein having power to tax or (2) any jurisdiction from or through which payment is made by or on behalf of the Issuer or any Guarantor (including, without limitation, the jurisdiction of any paying agent for the Notes) or any political subdivision thereof or therein (each, a “Tax Jurisdiction”) will at any time be required to be made from any payments made under or with respect to the Notes or any Note Guarantee, including, without limitation, payments of principal, redemption price, interest or premium, the Issuer or the relevant Guarantor, as applicable, will pay such additional amounts (the “Additional Amounts”) as may be necessary in order that the net amounts received in respect of such payments by each holder of the Notes after such withholding or deduction (including any such withholding or deduction from such Additional Amounts) will equal the respective amounts that would have been received in respect of such payments in the absence of such withholding or deduction; *provided, however*, that no Additional Amounts will be payable with respect to:

- (1) any Taxes, to the extent such Taxes would not have been imposed but for the existence of any actual or deemed present or former connection between the holder (or between a fiduciary, settler, beneficiary, member or shareholder of, or possessor of a power over the relevant holder, if the relevant holder is an estate, nominee, trust, partnership, limited liability company or corporation) or the beneficial owner of the Notes and the relevant Tax Jurisdiction (including, without limitation, being or having been a citizen, resident, or national thereof or being or having been present or engaged in a trade or business therein or having had a permanent establishment therein), other than connections arising from the holding of such Note or any Note Guarantee, the enforcement of rights under such Note or under a Note Guarantee or the receipt of any payments in respect of such Note or a Note Guarantee;
- (2) any Taxes, to the extent such Taxes were imposed as a result of the presentation of a Note for payment (where Notes are in the form of Definitive Registered Notes and presentation is required) more than 30 days after the relevant payment is first made available for payment to the holder (except to the extent that the holder would have been entitled to Additional Amounts had the Note been presented on the last day of such 30 day period);
- (3) any estate, inheritance, gift, sales, transfer, personal property or similar Taxes or any excise Taxes imposed on transfers;
- (4) any Taxes withheld, deducted or imposed on a payment to an individual that are required to be made pursuant to European Council Directive 2003/48/EC or any other directive implementing the conclusions of the ECOFIN Council meeting of November 26 and 27, 2000 on the taxation of savings income, or any law implementing or complying with or introduced in order to conform to, such directive;
- (5) Taxes imposed on or with respect to a payment made to a holder or beneficial owner of Notes who would have been able to avoid such withholding or deduction by presenting the relevant Note to another Paying Agent in a member state of the European Union;
- (6) any Taxes payable other than by deduction or withholding from payments under, or with respect to, the Notes or with respect to any Note Guarantee;
- (7) any Taxes to the extent such Taxes are imposed or withheld by reason of the failure of the holder or beneficial owner of Notes, to comply with any reasonable written request of the Issuer addressed to the holder or beneficial owner and made at least 60 days before any such withholding or deduction would be payable to satisfy any certification, identification, information or other reporting requirements, whether required by statute, treaty, regulation or administrative practice of the relevant Tax Jurisdiction, as a precondition to exemption from, or reduction in the rate of deduction or withholding of, Taxes imposed by such Tax Jurisdiction (including, without limitation, a certification that the holder or beneficial owner is not resident in the Tax Jurisdiction), but in each

case, only to the extent the holder or beneficial owner is legally eligible to provide such certification or documentation;

- (8) all United States federal backup withholding taxes;
- (9) any Taxes that are imposed or withheld pursuant to Sections 1471 through 1474 of the U.S. Internal Revenue Code of 1986, as amended (the “Code”), as of the Issue Date (or any amended or successor version of such sections), any regulations promulgated thereunder, any official interpretations thereof, any similar law or regulation adopted pursuant to an intergovernmental agreement between a non-U.S. jurisdiction and the United States with respect to the foregoing or any agreements entered into pursuant to section 1471(b)(1) of the Code; or
- (10) any combination of items (1) through (9) above.

Such Additional Amounts will also not be payable where, had the beneficial owner of the Note been the holder of the Note, it would not have been entitled to payment of Additional Amounts by reason of any of clauses (1) to (10) inclusive above.

In addition to the foregoing, the Issuer and the Guarantors, as the case may be, will also pay and indemnify the holder for any present or future stamp, issue, registration, court or documentary Taxes, or any other excise or property Taxes, charges or similar levies (including penalties, interest and any other reasonable expenses related thereto) which are levied by any Tax Jurisdiction on the execution, delivery, issuance, or registration of any of the Notes, the Indenture, any Note Guarantee or any other document or instrument referred to therein, or the receipt of any payments with respect thereto, or the enforcement of, any of the Notes or any Note Guarantee (limited, solely in the case of taxes attributable to the receipt of any payments with respect thereto, to any such taxes imposed in a Tax Jurisdiction that are not excluded under clauses (1) through (5) or (7) through (9) above).

If the Issuer or any Guarantor, as the case may be, becomes aware that it will be obligated to pay Additional Amounts with respect to any payment under or with respect to the Notes or any Note Guarantee, each of the Issuer or the relevant Guarantor, as the case may be, will deliver to the Trustee on a date that is at least 30 days prior to the date of that payment (unless the obligation to pay Additional Amounts arises less than 30 days prior to that payment date, in which case the Issuer or the relevant Guarantor shall notify the Trustee promptly thereafter) an Officer’s Certificate stating the fact that Additional Amounts will be payable and the amount estimated to be so payable. The Officer’s Certificate must also set forth any other information reasonably necessary to enable the Paying Agents to pay such Additional Amounts to holders on the relevant payment date. The Trustee shall be entitled to rely solely on such Officer’s Certificate as conclusive proof that such payments are necessary.

The Issuer or the relevant Guarantor will make all withholdings and deductions required by law and will remit the full amount deducted or withheld to the relevant Tax authority in accordance with applicable law. The Issuer or the relevant Guarantor will use its reasonable efforts to obtain Tax receipts from each Tax authority evidencing the payment of any Taxes so deducted or withheld. The Issuer or the relevant Guarantor will furnish to the Trustee (or to a holder or beneficial owner upon written request), within a reasonable time after the date the payment of any Taxes so deducted or withheld is made, certified copies of Tax receipts evidencing payment by the Issuer or a Guarantor, as the case may be, or if, notwithstanding such entity’s efforts to obtain receipts, receipts are not obtained, other evidence of payments (reasonably satisfactory to the Trustee) by such entity. Upon reasonable request, copies of Tax receipts or other evidence of payments, as the case may be, will be made available by the Trustee to the holders or beneficial owners of the Notes.

Whenever in the Indenture or in this “Description of Senior Notes” there is mentioned, in any context, the payment of amounts based upon the principal amount of the Notes or of principal, interest or of any other amount payable under, or with respect to, any of the Notes or any Note Guarantee, such mention shall be deemed to include mention of the payment of Additional Amounts to the extent that, in such context, Additional Amounts are, were or would be payable in respect thereof.

The above obligations will survive any termination, defeasance or discharge of the Indenture, and any transfer by a holder or beneficial owner of its Notes, and will apply, *mutatis mutandis*, to any jurisdiction in which any successor Person to the Issuer or any Guarantor is incorporated or organized, engaged in business for tax purposes or resident for tax purposes (and any political subdivision or governmental authority thereof or therein having power to tax) and any jurisdiction from or through which payment is made by or on behalf of such Person on the Notes or any Note Guarantee and any political subdivision thereof or therein.

Change of Control

If a Change of Control Triggering Event occurs, subject to the terms of the covenant described under this heading “Change of Control”, each Holder will have the right to require the Issuer to repurchase all or any part (equal to \$200,000 or an integral multiple of \$1,000 in excess thereof) of such Holder’s Notes at a purchase price in cash equal to 101% of the principal amount of the Notes, plus accrued and unpaid interest and Additional Amounts, if any, to the date of purchase (subject to the right of Holders of record on the relevant record date to receive interest due on the relevant interest payment date); *provided, however*, that the Issuer shall not be obliged to repurchase Notes as described under this heading, “Change of Control”, in the event and to the extent that it has unconditionally exercised its right to redeem all of the Notes as described under “—*Optional Redemption*” or all conditions to such redemption have been satisfied or waived. No such purchase in part shall reduce the principal amount at maturity of the Notes held by any holder to below \$200,000.

Unless the Issuer has unconditionally exercised its right to redeem all the Notes as described under “—*Optional Redemption*” or all conditions to such redemption have been satisfied or waived, no later than the date that is 60 days after any Change of Control Triggering Event or, at the Issuer’s option, at any time prior to a Change of Control Triggering Event following the public announcement thereof or if a definitive agreement is in place for the Change of Control, the Issuer will send a notice (the “Change of Control Offer”) to each Holder of any such Notes by mail or otherwise in accordance with the procedures set forth in the Indenture, with a copy to the Trustee:

- (1) stating that a Change of Control Triggering Event has occurred or may occur and that such Holder has the right to require the Issuer to purchase all or any part of such Holder’s Notes at a purchase price in cash equal to 101% of the principal amount of such Notes plus accrued and unpaid interest and Additional Amounts, if any, to, but not including, the date of purchase (subject to the right of Holders of record on a record date to receive interest on the relevant interest payment date) (the “Change of Control Payment”);
- (2) stating the repurchase date (which shall be no earlier than 30 days nor later than 60 days from the date such notice is mailed) (the “Change of Control Payment Date”) and the record date;
- (3) stating that any Note accepted for payment pursuant to the Change of Control Offer will cease to accrue interest after the Change of Control Payment Date unless the Change of Control Payment is not paid, and that any Notes or part thereof not tendered will continue to accrue interest;
- (4) describing the circumstances and relevant facts regarding the transaction or transactions that constitute the Change of Control Triggering Event;
- (5) describing the procedures determined by the Issuer, consistent with the Indenture, that a Holder must follow in order to have its Notes repurchased;
- (6) if such notice is mailed prior to the occurrence of a Change of Control Triggering Event, stating that the Change of Control Offer is conditional on the occurrence of such Change of Control Triggering Event; and
- (7) certain other procedures that a holder of Notes must follow to accept a Change of Control Offer or to withdraw such acceptance.

The Issuer shall cause to be published the notice described above in a leading newspaper having a general circulation in London (which is expected to be the *Financial Times*) or through the newswire service of Bloomberg (or if Bloomberg does not then operate, any similar agency). In addition, if and for so long as the Notes are listed on the Official List of the Luxembourg Stock Exchange and admitted for trading on the Euro MTF Market and the rules of the Luxembourg Stock Exchange so require, the Issuer will publish a public announcement with respect to the results of any Change of Control Offer in a leading newspaper of general circulation in Luxembourg (which is expected to be the *Luxemburger Wort*) or, to the extent and in the manner permitted by such rules, post such notice on the official website of the Luxembourg Stock Exchange. The ability of the Issuer to repurchase Notes pursuant to a Change of Control Offer may be limited by a number of factors. See “*Risk Factors—Risks Relating to the New Notes and the Structure—We may not be able to obtain enough funds necessary to finance an offer to repurchase the New Notes upon the occurrence of certain events constituting a change of control triggering event (as defined in the New Indentures) as required by the New Indentures*”.

On the Change of Control Payment Date, if the Change of Control Triggering Event shall have occurred, the Issuer will, to the extent lawful:

- (1) accept for payment all Notes or portion thereof properly tendered pursuant to the Change of Control Offer;

- (2) deposit with the Paying Agent an amount equal to the Change of Control Payment in respect of all Notes so tendered;
- (3) deliver or cause to be delivered to the Trustee an Officer's Certificate stating the aggregate principal amount of Notes or portions of the Notes being purchased by the Issuer in the Change of Control Offer;
- (4) in the case of Global Notes, deliver, or cause to be delivered, to the Principal Paying Agent the Global Notes in order to reflect thereon the portion of such Notes or portions thereof that have been tendered to and purchased by the Issuer; and
- (5) in the case of Definitive Registered Notes, deliver, or cause to be delivered, to the relevant Registrar for cancellation all Definitive Registered Notes accepted for purchase by the Issuer.

If any Definitive Registered Notes have been issued, the Paying Agent will, at the Issuer's expense, promptly mail to each Holder of Definitive Registered Notes so tendered the Change of Control Payment for such Notes, and the Trustee will promptly instruct its authenticating agent to authenticate and, at the Issuer's expense, mail (or cause to be transferred by book-entry) to each Holder of Definitive Registered Notes a new Definitive Registered Note equal in principal amount to the unpurchased portion of the Notes surrendered, if any; *provided* that each such new Note will be in a principal amount that is at least \$200,000 and integral multiples of \$1,000 in excess thereof.

For so long as the Notes are listed on the Euro MTF Market of the Luxembourg Stock Exchange and the rules of such exchange so require, the Issuer will publish a notice with respect to the results of the Change of Control Offer as soon as reasonably practicable after the Change of Control Payment Date on the official website of the Luxembourg Stock Exchange (www.bourse.lu).

The Change of Control provisions described above will be applicable whether or not any other provisions of the Indenture are applicable. Except as described above with respect to a Change of Control Triggering Event, the Indenture does not contain provisions that permit the Holders to require that the Issuer repurchase or redeem the Notes in the event of a takeover, recapitalization or similar transaction. The existence of a Holder's right to require the Issuer to repurchase such Holder's Notes upon the occurrence of a Change of Control Triggering Event may deter a third party from seeking to acquire Altice International or its Subsidiaries in a transaction that would constitute a Change of Control Triggering Event.

The Issuer will not be required to make a Change of Control Offer upon a Change of Control Triggering Event if a third party makes the Change of Control Offer in the manner, at the times and otherwise in compliance with the requirements set forth in the Indenture applicable to a Change of Control Offer made by the Issuer and purchases all Notes validly tendered and not withdrawn under such Change of Control Offer. Notwithstanding anything to the contrary herein, a Change of Control Offer may be made in advance of a Change of Control Triggering Event, conditional upon such Change of Control Triggering Event, if a definitive agreement is in place for the Change of Control at the time of making of the Change of Control Offer.

If Holders of not less than 90% in aggregate principal amount of the outstanding Notes validly tender and do not withdraw such Notes in a Change of Control Offer and the Issuer, or any third party making a Change of Control Offer in lieu of the Issuer as described above, purchases all of the Notes validly tendered and not withdrawn by such Holders, the Issuer or such third party will have the right, upon not less than 10 nor more than 60 days' prior notice, given not more than 30 days following such purchase pursuant to the Change of Control Offer described above, to redeem all Notes that remain outstanding following such purchase at a price in cash equal to 101% of the principal amount thereof plus accrued and unpaid interest to but excluding the date of the delivery of the notice for such redemption.

The provisions of the Indenture do not afford holders of the Notes the right to require the Issuer to repurchase the Notes in the event of a highly leveraged transaction, certain transactions with Altice International's management or its Affiliates or certain other sale transactions, including a reorganization, restructuring, merger or similar transaction (including, in certain circumstances, an acquisition of Altice International by management or its Affiliates) involving the Issuer that may adversely affect holders of the Notes, if such transaction is not a transaction defined as a Change of Control Triggering Event.

The Issuer will comply, to the extent applicable, with the requirements of Section 14(e) of the Exchange Act and any other securities laws or regulations in connection with the repurchase of Notes pursuant to this covenant. To the extent that the provisions of any securities laws or regulations conflict with provisions of the Indenture, the Issuer will comply with the applicable securities laws and regulations and will not be deemed to have breached its obligations under the Change of Control provisions of the Indenture by virtue of the conflict.

The Issuer's ability to repurchase Notes issued by it pursuant to a Change of Control Offer may be limited by a number of factors. The existing indebtedness of the Issuer, Altice International or the Restricted Subsidiaries contains, and its respective future indebtedness may also contain prohibitions of certain events that would constitute a "change of control" or require such Indebtedness to be repurchased or repaid upon such a change of control. Moreover, the exercise by the Holders of their right to require the Issuer to repurchase the Notes could cause a default under, or require a repurchase of, such Indebtedness, even if the Change of Control Triggering Event itself does not, due to the financial effect of such repurchase on the Issuer. Finally, the Issuer's ability to pay cash to the Holders upon a repurchase may be limited by Altice International's and its Restricted Subsidiaries' then existing financial resources. There can be no assurance that sufficient funds will be available when necessary to make any required repurchases. See "*Risk Factors—Risks Relating to the New Notes and the Structure—We may not be able to obtain enough funds necessary to finance an offer to repurchase the New Notes upon the occurrence of certain events constituting a change of control triggering event (as defined in the New Indentures) as required by the New Indentures*".

The definition of "Change of Control" includes a direct or indirect sale, lease, transfer, conveyance or other disposition of all or substantially all of the property and assets of Altice International and its Restricted Subsidiaries taken as a whole to a Person (including any "person" (as that term is used in Section 13(d)(3) of the Exchange Act)), other than a Permitted Holder. Although there is a limited body of case law interpreting the phrase "substantially all", there is no precise established definition of the phrase "substantially all" under applicable law. Accordingly, in certain circumstances there may be a degree of uncertainty as to whether a particular transaction would involve a disposition of "all or substantially all" of the property or assets of a Person. As a result, it may be unclear as to whether a Change of Control has occurred and whether a Holder may require the Issuer to make an offer to repurchase the Notes as described above. However, subject to the conditions specified in sub-clause (3) of "*Certain Definitions—Change of Control*", a Change of Control shall be deemed not to have occurred as a result of the sale, lease, transfer, conveyance or other disposition in one or a series of related transactions of any assets of Altice International and its Subsidiaries or the Target and its Subsidiaries (including the Capital Stock of the Target or any Subsidiary of Altice International or the Target) that is required pursuant to Competition Laws in relation to the Acquisition or is taken to avoid or eliminate any impediment under Competition Laws in relation to the Acquisition (including, without limitation, in response to any actions initiated by an administrative, regulatory or other governmental authority or private party under Competition Laws).

The provisions of the Indenture relating to the Issuer's obligation to make an offer to repurchase the Notes as a result of a Change of Control Triggering Event may be waived or modified with the written consent of holders of a majority in outstanding principal amount of the Notes.

Offer to Repurchase with Minority Shareholder Option Proceeds

Pursuant to the Minority Shareholder Call Options granted under the Minority Shareholder Purchase Agreements, each Minority Shareholder is entitled to re-acquire all or a portion of the shares of HOT sold by it to Cool in connection with the Take-Private Transaction at an exercise price equal to NIS 48 per share (subject to customary anti-dilution rights and purchase price adjustments) during the two-year period commencing on December 27, 2013. Subject to certain limitations, each Minority Shareholder Call Option may be exercised in up to three transactions. See "*Description of our Business—HOT Minority Shareholder Agreements*". The transfer of shares of Capital Stock of HOT upon any exercise of a Minority Shareholder Call Option will not be deemed to be an Asset Disposition under the Indenture. However, to the extent such proceeds are not used by the Senior Secured Notes Issuer to redeem the Senior Secured Notes, the Issuer will be required to offer to repurchase the Notes with the Net Cash Proceeds of such exercise as described below.

Any Net Cash Proceeds received by Altice International or any Restricted Subsidiary from any Minority Shareholder Option Exercise and not otherwise applied to repay or repurchase Senior Indebtedness of the Issuer will constitute "*Minority Shareholder Option Proceeds*". When the aggregate amount of Minority Shareholder Option Proceeds exceeds NIS 100 million (the "*Minority Shareholder Option Offer Threshold*"), the Issuer will be required within 35 Business Days to make an offer (a "*Minority Shareholder Option Proceeds Offer*") to all holders of Notes and, to the extent the Issuer elects or the Issuer or a Guarantor is required by the terms of other outstanding Pari Passu Indebtedness, to all holders of such other outstanding Pari Passu Indebtedness to purchase the maximum principal amount of Notes and any such Pari Passu Indebtedness to which such Minority Shareholder Option Proceeds Offer applies that may be purchased out of the Applicable Minority Shareholder Option Proceeds Offer Amount, at an offer price in respect of the Notes in an amount equal to (and, in the case of any Pari Passu Indebtedness, an offer price of no more than) 103% of the principal amount of the Notes and 103% of the principal amount of Pari Passu Indebtedness, in each case, plus accrued and unpaid interest, if any, to, but not including, the date of purchase, in accordance with the procedures set forth in the Indenture or the agreements governing the Pari Passu Indebtedness, as applicable, and in the case of the Notes, in minimum denominations of \$200,000 principal amount and in integral multiples of \$1,000 in excess thereof, *provided* that the Minority Shareholder Option Offer Threshold shall not apply in the event that (i) at the time of receipt of such Minority Shareholder Option Proceeds, all Minority Shareholder Call Options have been exercised in full, (ii) all unexercised Minority Shareholder Call Options have expired pursuant to the terms of the relevant Minority Shareholder Purchaser Agreements or (iii) all unexercised Minority Shareholder Call Options have been terminated.

To the extent that the aggregate amount of Notes and Pari Passu Indebtedness so validly tendered and not properly withdrawn pursuant to an Minority Shareholder Option Proceeds Offer is less than the Minority Shareholder Option Proceeds, Altice International may use any remaining Minority Shareholder Option Proceeds for general corporate purposes, to the extent not prohibited by the other covenants contained in the Indenture. If the aggregate principal amount of the Notes surrendered in any Minority Shareholder Option Proceeds Offer by Holders and other Pari Passu Indebtedness surrendered by holders or lenders, collectively, exceeds the Minority Shareholder Option Proceeds, the Minority Shareholder Option Proceeds shall be allocated among the Notes and Pari Passu Indebtedness to be purchased on a *pro rata* basis on the basis of the aggregate principal amount of tendered Notes and Pari Passu Indebtedness. For the purposes of calculating the principal amount of any such Indebtedness not denominated in euro, such Indebtedness shall be calculated by converting any such principal amounts into their Euro Equivalent determined as of a date selected by the Issuer that is within the Minority Shareholder Option Proceeds Offer Period (as defined below).

To the extent that any portion of Net Available Cash payable in respect of the Notes is denominated in a currency other than the currency in which the Notes are denominated, the amount thereof payable in respect of such Notes shall not exceed the net amount of funds in the currency in which such Notes are denominated that is actually received by the Issuer upon converting such portion of the Net Available Cash into such currency.

The Minority Shareholder Option Proceeds Offer, in so far as it relates to the Notes, will remain open for a period of not less than 20 Business Days following its commencement (the “*Minority Shareholder Option Proceeds Offer Period*”). No later than five (5) Business Days after the termination of the Minority Shareholder Option Proceeds Offer Period (the “*Minority Shareholder Option Proceeds Purchase Date*”), the Issuer will purchase the principal amount of Notes and, to the extent it elects, Pari Passu Indebtedness required to be purchased by it pursuant to this covenant (the “*Minority Shareholder Option Offer Amount*”) or, if less than the Minority Shareholder Option Offer Amount has been so validly tendered, all Notes and Pari Passu Indebtedness validly tendered in response to the Minority Shareholder Option Proceeds Offer.

On or before the Minority Shareholder Option Proceeds Purchase Date, the Issuer will, to the extent lawful, accept for payment, on a *pro rata* basis to the extent necessary, the Minority Shareholder Option Offer Amount of Notes and Pari Passu Indebtedness or portions of Notes and Pari Passu Indebtedness so validly tendered and not properly withdrawn pursuant to the Minority Shareholder Option Proceeds Offer, or if less than the Minority Shareholder Option Offer Amount has been validly tendered and not properly withdrawn, all Notes and Pari Passu Indebtedness so validly tendered and not properly withdrawn and, in the case of the Notes, in minimum denominations of \$200,000 and in integral multiples of \$1,000 in excess thereof. The Issuer will deliver to the Trustee an Officer’s Certificate stating that such Notes or portions thereof were accepted for payment by the Issuer in accordance with the terms of this covenant. The Issuer or the Paying Agent, as the case may be, will promptly (but in any case not later than five (5) Business Days after termination of the Minority Shareholder Option Proceeds Offer Period) mail or deliver to each tendering Holder of Notes an amount equal to the purchase price of the Notes so validly tendered and not properly withdrawn by such Holder, and accepted by the Issuer for purchase, and the Issuer will promptly issue a new Note and in the case of Definitive Registered Notes, deliver or cause to be delivered to the relevant Registrar for cancellation all Definitive Registered Notes accepted for purchase by the Issuer (or, in the case of Global Notes, cause the Paying Agent to reduce the aggregate principal amount of the applicable Global Note), and the Trustee, upon receipt of an Officer’s Certificate from the Issuer, will authenticate and mail or deliver (or cause to be transferred by book-entry) such new Note to such Holder, in a principal amount equal to any unpurchased portion of the Note surrendered; *provided* that each such new Note will be in a principal amount with a minimum denomination of \$200,000. Any Note not so accepted will be promptly mailed or delivered (or transferred by book-entry) by the Issuer to the Holder thereof.

Certain Covenants

Limitation on Indebtedness

Altice International will not, and will not permit any of its Restricted Subsidiaries to, Incur any Indebtedness (including Acquired Indebtedness); *provided, however*, that:

- (1) the Senior Secured Notes Issuer may Incur Senior Secured Indebtedness if on the date on which such Senior Secured Indebtedness is Incurred, the Consolidated Net Senior Secured Leverage Ratio would have been no greater than 3.0 to 1.0 determined on a *pro forma* basis (including a *pro forma* application of the net proceeds therefrom), as if such Senior Secured Indebtedness had been incurred at the beginning of the relevant period; and
- (2) the Issuer may Incur Pari Passu Indebtedness if on the date of such Incurrence and after giving effect thereto on a *pro forma* basis the Consolidated Net Leverage Ratio would not exceed 4.0 to 1.0, determined on a *pro forma* basis (including a *pro forma* application of the net proceeds therefrom), as if such Pari Passu Indebtedness had been incurred at the beginning of the relevant period.

The first paragraph of this covenant will not prohibit the Incurrence of the following items of Indebtedness:

- (1) Indebtedness Incurred pursuant to any Credit Facility (including in respect of letters of credit or bankers' acceptances issued or created thereunder), and any Refinancing Indebtedness in respect thereof, in a maximum aggregate principal amount at any time outstanding not to exceed the greater of €1,500 million and 80% of Consolidated EBITDA; *plus* in the case of any refinancing of any Indebtedness permitted under this clause (1) or any portion thereof, the aggregate amount of fees, underwriting discounts, premiums and other costs and expenses Incurred in connection with such refinancing;
- (2) (a) Guarantees by Altice International or any Restricted Subsidiary of Indebtedness of Altice International or any Restricted Subsidiary to the extent such guaranteed Indebtedness was permitted to be incurred by another provision of this covenant; *provided* that (i) if such Indebtedness is subordinated in right of payment to, or *pari passu* in right of payment with, the Notes or a Note Guarantee, as applicable, then the Guarantee of such Indebtedness shall be subordinated in right of payment to, or *pari passu* in right of payment with, the Notes or such Note Guarantee, as applicable, substantially to the same extent as such guaranteed Indebtedness and (ii) if such guarantee is of Indebtedness of the Issuer or a Guarantor, such Restricted Subsidiary complies with the first paragraph of the covenant described under "*—Additional Guarantors*"; or (b) without limiting the covenant described under "*—Limitation on Liens*", Indebtedness arising by reason of any Lien granted by or applicable to Altice International or any Restricted Subsidiary securing Indebtedness of Altice International or any Restricted Subsidiary so long as the Incurrence of such Indebtedness is not prohibited by the terms of the Indenture;
- (3) Indebtedness of Altice International owing to and held by any Restricted Subsidiary or Indebtedness of a Restricted Subsidiary owing to and held by Altice International or any other Restricted Subsidiary; *provided, however,* that:
 - (a) if the Issuer or any Guarantor is the obligor on such Indebtedness and the payee is not the Issuer or a Guarantor, such Indebtedness must be unsecured and ((i) except in respect of the intercompany current liabilities incurred in connection with cash management positions of Altice International and the Restricted Subsidiaries and (ii) only to the extent legally permitted (Altice International and the Restricted Subsidiaries having completed all procedures required in the reasonable judgment of directors or officers of the obligee or obligor to protect such Persons from any penalty or civil or criminal liability in connection with the subordination of such Indebtedness)) expressly subordinated to the prior payment in full in cash of all obligations then due with respect to the Notes, in the case of the Issuer, or the Note Guarantee, in the case of a Guarantor; *provided* that:
 - (i) any subsequent issuance or transfer of Capital Stock or any other event which results in any such Indebtedness being beneficially held by a Person other than Altice International or a Restricted Subsidiary; and
 - (ii) any sale or other transfer of any such Indebtedness to a Person other than Altice International or a Restricted Subsidiary,

shall be deemed, in each case, to constitute an Incurrence of such Indebtedness not permitted by this clause (3) by Altice International or such Restricted Subsidiary, as the case may be;

- (4) (a) Indebtedness represented by the Notes (other than any Additional Notes) issued on the Issue Date and the Note Guarantees and the Indebtedness under the New Senior Credit Facility incurred on or prior to the Completion Date in an aggregate amount not to exceed €841 million (equivalent as of the date of the New Senior Credit Facility) and the Guarantees thereof, (b) any Indebtedness (other than Indebtedness described in clauses (1) and (3) of this paragraph) outstanding on the Issue Date, after giving effect to the Transactions, including the Issuance of the Notes and the application of the proceeds thereof (including after such proceeds of the Notes are released from the Escrow Account), (c) Refinancing Indebtedness Incurred in exchange for, or the net proceeds of which are used to renew, refund, refinance, replace, defease or discharge any, or otherwise Incurred in respect of any, Indebtedness described in sub-clauses (a), (b) or (c) of this clause (4) or clause (5) of this paragraph or Incurred pursuant to the first paragraph of this covenant, (d) Management Advances and (e) Indebtedness represented by the Security Documents, the HOT Security Documents and the OMT Proceeds Loans Security Documents and, including, with respect to each such Indebtedness "parallel debt" obligations created under the Intercreditor Agreement, the Security Documents, the HOT Security Documents and the OMT Proceeds Loans Security Documents;
- (5) Indebtedness of (i) any Person outstanding on the date on which such Person becomes a Restricted Subsidiary or is merged, consolidated, amalgamated or otherwise combined with (including pursuant to any acquisition of assets and assumption of related liabilities) Altice International or a Restricted Subsidiary or (ii) the Issuer or a

Guarantor Incurred to provide all or any portion of the funds utilized to consummate the transaction or series of related transactions pursuant to which a Person became a Restricted Subsidiary or was otherwise acquired by Altice International or a Restricted Subsidiary or otherwise in connection with or contemplation of such acquisition; *provided, however*, with respect to each of clause (5)(i) and (5)(ii), that immediately following the consummation of such acquisition or other transaction, (x)(i) if such Indebtedness is Senior Secured Indebtedness, the Senior Secured Notes Issuer would have been able to Incur €1.00 of additional Indebtedness pursuant to the first paragraph of this covenant after giving effect to the Incurrence of such Indebtedness pursuant to this clause (5) or (ii) the Consolidated Net Senior Secured Leverage Ratio would not be greater than it was immediately prior to giving effect to such acquisition or other transaction; and (y)(i) if such Indebtedness is not Senior Secured Indebtedness, the Issuer would have been able to Incur € 1.00 of additional Indebtedness pursuant to the first paragraph of this covenant after giving effect to the Incurrence of such Indebtedness pursuant to this clause (5) or (ii) the Consolidated Net Leverage Ratio would not be greater than it was immediately prior to giving effect to such acquisition or other transaction;

- (6) [Reserved];
- (7) (a) Indebtedness under Currency Agreements (other than Currency Agreements described in (b) below), Interest Rate Agreements and Commodity Hedging Agreements and (b) Indebtedness under Currency Agreements entered into in order to hedge any operating expenses and capital expenditures Incurred in the ordinary course of business so long as (i) such operating expenses and capital expenditures are denominated in euro or U.S. dollars and (ii) the term of any such Currency Agreement is not more than 360 days; in each case with respect to clauses (a) and (b) hereof, entered into for *bona fide* hedging purposes of Altice International or the Restricted Subsidiaries and not for speculative purposes (as determined in good faith by an Officer or the Board of Directors of Altice International);
- (8) Indebtedness consisting of (A) mortgage financings, Purchase Money Obligations or other financings Incurred for the purpose of financing all or any part of the purchase price or cost of design, construction, installation or improvement of property (real or personal), plant or equipment or other assets (including Capital Stock) used or useful in a Similar Business or (B) Indebtedness otherwise Incurred to finance the purchase, lease, rental or cost of design, construction, installation or improvement of property (real or personal), plant or equipment that is used or useful in a Similar Business, whether through the direct purchase of assets or the Capital Stock of any Person owning such assets, and any Indebtedness which refinances, replaces or refunds such Indebtedness, in an aggregate outstanding principal amount which, when taken together with the principal amount of all other Indebtedness Incurred pursuant to this clause (8) and then outstanding, will not exceed at any time outstanding the greater of €350 million and 2.8% of Total Assets;
- (9) Indebtedness in respect of (a) workers' compensation claims, self-insurance obligations, performance, indemnity, surety, judgment, appeal, advance payment, customs, VAT or other tax or other guarantees or other similar bonds, instruments or obligations and completion guarantees and warranties provided by Altice International or a Restricted Subsidiary or relating to liabilities, obligations or guarantees Incurred in the ordinary course of business or in respect of any governmental requirement, including in relation to a governmental requirement to provide a guarantee or bond, (b) letters of credit, bankers' acceptances, guarantees or other similar instruments or obligations issued or relating to liabilities or obligations Incurred in the ordinary course of business, *provided, however*, that upon the drawing of such letters of credit or other instrument, such obligations are reimbursed within 30 days following such drawing; (c) the financing of insurance premiums in the ordinary course of business; and (d) any customary cash management, cash pooling or netting or setting off arrangements in the ordinary course of business;
- (10) Indebtedness arising from agreements providing for customary guarantees, indemnification, obligations in respect of earnouts or other adjustments of purchase price or, in each case, similar obligations, in each case, Incurred or assumed in connection with the acquisition or disposition of any business or assets or Person or any Capital Stock of a Subsidiary (other than Guarantees of Indebtedness Incurred by any Person acquiring or disposing of such business or assets or such Subsidiary for the purpose of financing such acquisition or disposition); *provided* that the maximum liability of Altice International and the Restricted Subsidiaries in respect of all such Indebtedness in connection with such disposition shall at no time exceed the gross proceeds, including the fair market value of non-cash proceeds (measured at the time received and without giving effect to any subsequent changes in value), actually received by Altice International and the Restricted Subsidiaries in connection with such disposition;
- (11) Indebtedness arising from the honoring by a bank or other financial institution of a check, draft or similar instrument drawn against insufficient funds in the ordinary course of business; *provided, however*, that such Indebtedness is extinguished within 30 Business Days of Incurrence;

- (12) Indebtedness under daylight borrowing facilities incurred in connection with any refinancing of Indebtedness (including by way of set-off or exchange); *provided* that such Indebtedness does not exceed the principal amount of the Indebtedness being refinanced and the aggregate amount of fees, underwriting discounts, premiums and other costs and expenses Incurred in connection with such refinancing, so long as any such Indebtedness is repaid within three days of the date on which such Indebtedness is Incurred;
- (13) Indebtedness Incurred by a Receivables Subsidiary in a Qualified Receivables Financing;
- (14) Indebtedness Incurred by the Issuer or a Guarantor (including any Refinancing Indebtedness in respect thereof) or Disqualified Stock of Altice International in an aggregate outstanding principal amount which, when taken together with the principal amount of all other Indebtedness Incurred pursuant to this clause (14) and then outstanding, will not exceed 100% of the Net Cash Proceeds received by Altice International and the Restricted Subsidiaries from the issuance or sale (other than to Altice International or a Restricted Subsidiary) of its Subordinated Shareholder Funding (other than the AI Mandatory Convertible Notes) or Capital Stock (other than Disqualified Stock, Designated Preference Shares or an Excluded Contribution) or otherwise contributed to the equity (other than through the issuance of Disqualified Stock, Designated Preference Shares or an Excluded Contribution) of Altice International, in each case, subsequent to the Issue Date; *provided, however*, that (i) any such Net Cash Proceeds that are so received or contributed shall be excluded for purposes of making Restricted Payments under the first paragraph and clauses (1), (6) and (10) of the third paragraph of the covenant described below under “—*Certain Covenants—Limitation on Restricted Payments*” to the extent Altice International or a Restricted Subsidiary incurs Indebtedness in reliance thereon and (ii) any Net Cash Proceeds that are so received or contributed shall be excluded for purposes of Incurring Indebtedness pursuant to this clause (14) to the extent Altice International or any Restricted Subsidiary makes a Restricted Payment under the first paragraph and clauses (1), (6) and (10) of the third paragraph of the covenant described below under “—*Certain Covenants—Limitation on Restricted Payments*” in reliance thereon;
- (15) Indebtedness Incurred (including any Refinancing Indebtedness in respect thereof) in an aggregate outstanding principal amount which, when taken together with the principal amount of all other Indebtedness Incurred pursuant to this clause (15) and then outstanding, will not exceed the greater of €500 million and 4.0% of Total Assets.

Notwithstanding the foregoing, for so long as NewCo OMT is not a Guarantor, NewCo OMT and its Subsidiaries shall not be permitted to Incur more than €30 million of Indebtedness at any time outstanding excluding any Indebtedness referred to in clauses (2)(a) (to the extent the Guarantee(s) relate to Indebtedness Incurred under clause (3) above), (3), (4)(c), (5), (8), (9), (10) and (11) of the second paragraph of this covenant.

In the event the Issuer Incurs any Indebtedness pursuant to the first paragraph of this covenant or clauses (8), (14) or (15) of the second paragraph of this covenant, the Issuer will substantially concurrently with the Incurrence of such Indebtedness (or in the case of any Indebtedness the proceeds of which are deposited into an escrow account or similar arrangement pending the occurrence of one or more events, concurrently with the release of such proceeds from such escrow account or similar arrangement (other than in the case that such proceeds are returned to the holders of, or lenders under, such Indebtedness pursuant to the terms of such escrow account or similar arrangement)), make one or more Proceeds Loans to one or more Guarantors with all or substantially all of the net proceeds of the Incurrence of such Indebtedness by the Issuer.

In the event the Senior Secured Notes Issuer Incurs any Indebtedness pursuant to the first paragraph of this covenant or clauses (8), (14) or (15) of the second paragraph of this covenant, the Senior Secured Notes Issuer will substantially concurrently with the Incurrence of such Indebtedness (or in the case of any Indebtedness the proceeds of which are deposited into an escrow account or similar arrangement pending the occurrence of one or more events, concurrently with the release of such proceeds from such escrow account or similar arrangement (other than in the case that such proceeds are returned to the holders of, or lenders under, such Indebtedness pursuant to the terms of such escrow account or similar arrangement)), make one or more Finco Proceeds Loans to one or more Guarantors or (prior to the HOT Direct Obligation Event) to HOT and any of its Subsidiaries that are HOT Proceeds Note Guarantors (so long as HOT or such Subsidiary grants a Lien over its material assets and, in the case of such Subsidiary provides a HOT Proceeds Note Guarantee, in the amount of such additional Finco Proceeds Loan) with all or substantially all of the net proceeds of the Incurrence of such Indebtedness by the Senior Secured Notes Issuer.

For purposes of determining compliance with, and the outstanding principal amount of any particular Indebtedness Incurred pursuant to and in compliance with, this covenant:

- (1) in the event that Indebtedness meets the criteria of more than one of the types of Indebtedness described in the first and second paragraphs of this covenant, the Issuer, in its sole discretion, will classify, and may from time to time reclassify, such item of Indebtedness and only be required to include the amount and type of such

Indebtedness in one of the clauses of the second paragraph or the first paragraph of this covenant; *provided* that Indebtedness Incurred under clause (1) of the second paragraph of the description of this covenant cannot be reclassified;

- (2) Guarantees of, or obligations in respect of letters of credit, bankers' acceptances or other similar instruments relating to, or Liens securing, Indebtedness that is otherwise included in the determination of a particular amount of Indebtedness shall not be included;
- (3) if obligations in respect of letters of credit, bankers' acceptances or other similar instruments are Incurred pursuant to any Credit Facility and are being treated as Incurred pursuant to clause (1), (8), (14) or (15) of the second paragraph above or the first paragraph above and the letters of credit, bankers' acceptances or other similar instruments relate to other Indebtedness, then such other Indebtedness shall not be included;
- (4) the principal amount of any Disqualified Stock of Altice International or a Restricted Subsidiary, or Preferred Stock of Altice International or a Restricted Subsidiary, will be equal to the greater of the maximum mandatory redemption or repurchase price (not including, in either case, any redemption or repurchase premium) or the liquidation preference thereof;
- (5) Indebtedness permitted by this covenant need not be permitted solely by reference to one provision permitting such Indebtedness but may be permitted in part by one such provision and in part by one or more other provisions of this covenant permitting such Indebtedness; and
- (6) the amount of Indebtedness issued at a price that is less than the principal amount thereof will be equal to the amount of the liability in respect thereof determined on the basis of IFRS.

Accrual of interest, accrual of dividends, the accretion of accreted value, the accretion or amortization of original issue discount, the payment of interest in the form of additional Indebtedness, the payment of dividends in the form of additional shares of Preferred Stock or Disqualified Stock or the reclassification of commitments or obligations not treated as Indebtedness due to a change in IFRS will not be deemed to be an Incurrence of Indebtedness for purposes of this covenant. The amount of any Indebtedness outstanding as of any date shall be (a) the accreted value thereof in the case of any Indebtedness issued with original issue discount and (b) the principal amount, or liquidation preference thereof, in the case of any other Indebtedness.

If at any time an Unrestricted Subsidiary becomes a Restricted Subsidiary, any Indebtedness of such Subsidiary shall be deemed to be Incurred by a Restricted Subsidiary as of such date (and, if such Indebtedness is not permitted to be Incurred as of such date under the covenant described under this "*—Limitation on Indebtedness*", the Issuer shall be in Default of this covenant).

For purposes of determining compliance with any euro-denominated restriction on the Incurrence of Indebtedness, the Euro Equivalent of the principal amount of Indebtedness denominated in another currency shall be calculated based on the relevant currency exchange rate in effect on the date such Indebtedness was Incurred, in the case of term Indebtedness, or at the option of the Issuer, the date first committed, in the case of Indebtedness Incurred under a revolving credit facility; *provided* that (a) if such Indebtedness is Incurred to refinance other Indebtedness denominated in a currency other than euro, and such refinancing would cause the applicable euro-denominated restriction to be exceeded if calculated at the relevant currency exchange rate in effect on the date of such refinancing, such euro-denominated restriction shall be deemed not to have been exceeded so long as the principal amount of such Refinancing Indebtedness does not exceed the principal amount of such Indebtedness being refinanced; (b) the Euro Equivalent of the principal amount of any such Indebtedness outstanding on the Issue Date shall be calculated based on the relevant currency exchange rate in effect on the Issue Date; and (c) if any such Indebtedness that is denominated in a currency other than euro is subject to a Currency Agreement with respect to the currency in which such Indebtedness is denominated covering principal amount and interest payable on such Indebtedness, the amount of such Indebtedness, will be the Euro Equivalent of the principal payment required to be made under such Currency Agreement plus the Euro Equivalent of any premium which is at such time due and payable but is not covered by such Currency Agreement.

For purposes of determining compliance with the Consolidated Net Senior Secured Leverage Ratio or the Consolidated Net Leverage Ratio on the Incurrence of Indebtedness, the Euro Equivalent of the principal amount of Indebtedness denominated in another currency shall be calculated based on the relevant currency exchange rate in effect on the date such Indebtedness was Incurred, in the case of term Indebtedness, or at the option of the Issuer, the date first committed, in the case of Indebtedness Incurred under a revolving credit facility; *provided* that (a) if such Indebtedness is Incurred to refinance other Indebtedness denominated in a currency other than euro, and such refinancing would cause the applicable euro-denominated restriction to be exceeded if calculated at the relevant currency exchange rate in effect on the date of such refinancing, such euro-denominated restriction shall be deemed not to have been exceeded so long as the principal amount of such Refinancing Indebtedness does not exceed the principal amount of such Indebtedness being refinanced;

and (b) the Euro Equivalent of the principal amount of any such Indebtedness outstanding on the Issue Date shall be calculated based on the relevant currency exchange rate in effect on the Issue Date.

In addition, for purposes of calculating the Consolidated Net Senior Secured Leverage Ratio or the Consolidated Net Leverage Ratio to test compliance with any covenant in the Indenture, in determining the amount of Indebtedness outstanding in euro on any date of determination, with respect to any Indebtedness denominated in a currency other than euro (the “Foreign Currency”):

- (1) subject to a currency swap arrangement or contract, the aggregate principal amount of such Foreign Currency Indebtedness on any such date of determination shall be the euro amount of the aggregate principal amount to be paid by the Issuer or a Restricted Subsidiary on the maturity date of such currency swap arrangement or contract pursuant to the terms thereof; or
- (2) subject to a currency forward arrangement, forward accretion curve or contract, the aggregate principal amount of such Foreign Currency Indebtedness shall be converted into euro at the exchange rate specified under the terms of such currency forward arrangement, forward accretion curve or contract as applicable to such Foreign Currency Indebtedness on such date of determination.

For the avoidance of doubt, notwithstanding a Group member entering into any such arrangement or contract hedging foreign exchange exposure of any Foreign Currency Indebtedness, for the purposes of calculating the Consolidated Net Senior Secured Leverage Ratio or the Consolidated Net Leverage Ratio, the aggregate principal amount of Indebtedness subject to any such arrangement or contract shall be attributed to the total Indebtedness of the Person that originally Incurred such Indebtedness.

Notwithstanding any other provision of this covenant, the maximum amount of Indebtedness that Altice International or a Restricted Subsidiary may Incur pursuant to this covenant shall not be deemed to be exceeded solely as a result of fluctuations in the exchange rate of currencies.

Limitation on Restricted Payments

Altice International will not, and will not permit any of its Restricted Subsidiaries to, directly or indirectly:

- (1) declare or pay any dividend or make any other payment or distribution on account of or in respect of Altice International’s or any Restricted Subsidiary’s Capital Stock (including, without limitation, any payment in connection with any merger or consolidation involving Altice International or any Restricted Subsidiary) except:
 - (a) dividends or distributions payable in Capital Stock of Altice International (other than Disqualified Stock) or in options, warrants or other rights to purchase such Capital Stock of Altice International (other than Disqualified Stock) or in Subordinated Shareholder Funding; and
 - (b) dividends or distributions payable to Altice International or a Restricted Subsidiary (and, in the case of any such Restricted Subsidiary making such dividend or distribution, to holders of its Capital Stock other than Altice International or another Restricted Subsidiary on no more than a *pro rata* basis, measured by value);
- (2) purchase, redeem, retire or otherwise acquire for value (including, without limitation, any payment in connection with any merger or consolidation involving the Issuer or Altice International) any (a) Capital Stock of Altice International or any direct or indirect Parent of Altice International held by Persons other than Altice International or a Restricted Subsidiary (other than in exchange for Capital Stock of Altice International (other than Disqualified Stock)) or (b) Capital Stock of HOT (including the Minority Shareholder Call Options) held by any party to a Minority Shareholder Purchase Agreement (other than Cool);
- (3) make any principal payment on, or purchase, repurchase, redeem, defease or otherwise acquire or retire for value, prior to scheduled maturity, scheduled repayment or scheduled sinking fund payment, any Subordinated Indebtedness (other than (a) any such payment, purchase, repurchase, redemption, defeasance or other acquisition or retirement or in anticipation of satisfying a sinking fund obligation, principal installment or final maturity, in each case, due within one year of the date of payment, purchase, repurchase, redemption, defeasance or other acquisition or retirement; and (b) any Indebtedness Incurred pursuant to clause (3) of the second paragraph of the covenant described under “—*Limitation on Indebtedness*”);
- (4) make any cash payment on or with respect to, or purchase, redeem, defease or otherwise acquire or retire for value any Subordinated Shareholder Funding; or

- (5) make any Restricted Investment in any Person;

(any such dividend, distribution, payment, purchase, redemption, repurchase, defeasance, other acquisition, retirement or Restricted Investment referred to in clauses (1) through (5) are referred to herein as a “Restricted Payment”), if at the time Altice International or a Restricted Subsidiary makes such Restricted Payment:

- (a) a Default or Event of Default shall have occurred and be continuing (or would result immediately thereafter therefrom);
- (b) the Issuer is not able to Incur an additional €1.00 of Indebtedness pursuant to the first paragraph of the covenant described under “—*Limitation on Indebtedness*” after giving effect, on a *pro forma* basis, to such Restricted Payment; or
- (c) the aggregate amount of such Restricted Payment and all other Restricted Payments made by Altice International and the Restricted Subsidiaries subsequent to December 12, 2012 (and not returned or rescinded) (including Permitted Payments permitted below by clauses (5) (without duplication of amounts paid pursuant to any other clause of the immediately succeeding paragraph), (6), (10), (17) and (18) of the immediately succeeding paragraph, but excluding all other Restricted Payments permitted by the immediately succeeding paragraph) would exceed the sum of (without duplication):
- (i) an amount equal to 100% of the Consolidated EBITDA for the period beginning on the first day of the first full fiscal quarter commencing prior to December 12, 2012 to the end of Altice International’s most recently ended full fiscal quarter ending prior to the date of such Restricted Payment for which internal consolidated financial statements of Altice International are available, taken as a single accounting period, less the product of 1.5 times the Consolidated Interest Expense for such period;
- (ii) 100% of the aggregate Net Cash Proceeds, and the fair market value (as determined in accordance with the second last paragraph of this covenant) of property or assets or marketable securities, received by Altice International from the issue or sale of its Capital Stock (other than Disqualified Stock or Designated Preference Shares) or Subordinated Shareholder Funding subsequent to the Issue Date or otherwise contributed to the equity (other than through the issuance of Disqualified Stock or Designated Preference Shares) of Altice International subsequent to the Issue Date (other than (w) Net Cash Proceeds or property or assets or marketable securities received from an issuance or sale of such Capital Stock to Altice International or a Restricted Subsidiary or an employee stock ownership plan or trust established by Altice International or any Subsidiary of Altice International for the benefit of its employees to the extent funded by Altice International or any Restricted Subsidiary, (x) Net Cash Proceeds or property or assets or marketable securities to the extent that any Restricted Payment has been made from such proceeds in reliance on clause (6) of the immediately succeeding paragraph, (y) Excluded Contributions, and (z) Net Cash Proceeds received from the AI Mandatory Convertible Notes);
- (iii) 100% of the aggregate Net Cash Proceeds, and the fair market value (as determined in accordance with the second last paragraph of this covenant) of property or assets or marketable securities, received by Altice International or any Restricted Subsidiary from the issuance or sale (other than to Altice International or a Restricted Subsidiary or an employee stock ownership plan or trust established by Altice International or any Subsidiary of Altice International for the benefit of its employees to the extent funded by Altice International or any Restricted Subsidiary) by Altice International or any Restricted Subsidiary subsequent to the Issue Date of any Indebtedness that has been converted into or exchanged for Capital Stock of Altice International (other than Disqualified Stock or Designated Preference Shares) or Subordinated Shareholder Funding (plus the amount of any cash, and the fair market value (as determined in accordance with the second last paragraph of this covenant) of property or assets or marketable securities, received by Altice International or any Restricted Subsidiary upon such conversion or exchange) but excluding (x) Net Cash Proceeds or property or assets or marketable securities to the extent that any Restricted Payment has been made from such proceeds in reliance on clause (6) of the immediately succeeding paragraph, and (y) Excluded Contributions;
- (iv) the amount equal to the net reduction in Restricted Investments made by Altice International or any of the Restricted Subsidiaries resulting from repurchases, redemptions or other acquisitions or retirements of any such Restricted Investment, proceeds realized upon the sale or other disposition to a Person other than Altice International or a Restricted Subsidiary of any such Restricted Investment, repayments of loans or advances or other transfers of assets (including by way of dividend, distribution, interest payments or returns of capital) to Altice International or any Restricted Subsidiary, which amount, in each case under this clause (iv), constituted a Restricted Payment made after the Issue Date;

provided, however, that no amount will be included in Consolidated EBITDA for purposes of the preceding clause (i) to the extent that it is (at the Issuer's option) included under this clause (iv);

- (v) the amount of the cash and the fair market value (as determined in accordance with the second last paragraph of this covenant) of property, assets or marketable securities received by Altice International or any Restricted Subsidiary in connection with:
 - (A) the sale or other disposition (other than to Altice International or a Restricted Subsidiary or an employee stock ownership plan or trust established by Altice International or any Subsidiary of Altice International for the benefit of its employees to the extent funded by Altice International or any Restricted Subsidiary) of Capital Stock of an Unrestricted Subsidiary of Altice International; and
 - (B) any dividend or distribution made by an Unrestricted Subsidiary to Altice International or a Restricted Subsidiary;

which Unrestricted Subsidiary was designated as such after the Issue Date; *provided, however*, that no amount will be included in Consolidated EBITDA for purposes of the preceding clause (i) to the extent that it is (at the Issuer's option) included under this clause (v); and

- (vi) in the case of the designation of an Unrestricted Subsidiary as a Restricted Subsidiary or all of the assets of such Unrestricted Subsidiary are transferred to Altice International or a Restricted Subsidiary, or the Unrestricted Subsidiary is merged or consolidated into Altice International or a Restricted Subsidiary, 100% of such amount received in cash and the fair market value (as determined in accordance with the second last paragraph of this covenant) of any property, assets or marketable securities received by Altice International or Restricted Subsidiary in respect of such redesignation, merger, consolidation or transfer of assets, excluding any amount of any Investment in such Unrestricted Subsidiary pursuant to clause (16) of the definition of "Permitted Investment", in each case of this clause (vi), which Unrestricted Subsidiary was designated as such after the Issue Date; *provided however*, that no amount will be included in Consolidated EBITDA for purposes of the preceding clause (i) to the extent that it is (at the Issuer's option) included under this clause (vi); *provided further, however*, that such amount shall not exceed the amount included in the calculation of the amount of Restricted Payments referred to in the first sentence of this clause (c).

The foregoing provisions will not prohibit any of the following (collectively, "Permitted Payments"):

- (1) any Restricted Payment made in exchange (including any such exchange pursuant to the exercise of a conversion right or privilege in connection with which cash is paid in lieu of the issuance of fractional shares) for, or out of the Net Cash Proceeds of the substantially concurrent sale (other than to Altice International or a Subsidiary of Altice International) of, Capital Stock of Altice International (other than Disqualified Stock or Designated Preference Shares or through an Excluded Contribution), Subordinated Shareholder Funding (other than the AI Mandatory Convertible Notes) or a substantially concurrent contribution to the equity (other than through the issuance of Disqualified Stock or Designated Preference Shares or through an Excluded Contribution) of Altice International; *provided, however*, that to the extent so applied, the Net Cash Proceeds, or fair market value (as determined in accordance with the second last paragraph of this covenant) of property, assets or marketable securities, from such sale of Capital Stock or Subordinated Shareholder Funding or such contribution will be excluded from clause (c)(ii) of the preceding paragraph and for purposes of the "Optional Redemption" provisions of the Indenture;
- (2) any purchase, repurchase, redemption, defeasance or other acquisition or retirement of Subordinated Indebtedness of the Issuer or any Guarantor made by exchange for, or out of the Net Cash Proceeds of the substantially concurrent Incurrence of, Refinancing Indebtedness permitted to be Incurred pursuant to the covenant described under "*—Limitation on Indebtedness*" above;
- (3) (a) any purchase, repurchase, redemption, defeasance or other acquisition or retirement of Preferred Stock of Altice International or a Restricted Subsidiary made by exchange for or out of the Net Cash Proceeds of the substantially concurrent sale of Preferred Stock of Altice International or a Restricted Subsidiary, and (b) any purchase, repurchase, redemption, defeasance or other acquisition or retirement of Disqualified Stock of Altice International or a Restricted Subsidiary made by exchange for or out of the Net Cash Proceeds of the substantially concurrent sale of Disqualified Stock of Altice International or a Restricted Subsidiary, as the case may be, that, in each case under (a) and (b), is permitted to be Incurred pursuant to the covenant described under "*—Limitation on Indebtedness*" above, and that in each case (other than such sale of Preferred Stock of Altice International that is not Disqualified Stock), constitutes Refinancing Indebtedness;

- (4) any purchase, repurchase, redemption, defeasance or other acquisition or retirement of Subordinated Indebtedness:
- (a) (i) from Net Cash Proceeds of the Minority Shareholder Option Exercises permitted under “—*Offer to Repurchase with Minority Shareholder Option Proceeds*” above and from Net Available Cash to the extent permitted under “—*Limitation on Sales of Assets and Subsidiary Stock*” below, but only if the Issuer shall have first complied with the terms described under “—*Offer to Repurchase with Minority Shareholder Option Proceeds*” above and “—*Limitation on Sales of Assets and Subsidiary Stock*”, as applicable, and purchased all Notes tendered pursuant to any offer to repurchase all the Notes required thereby, prior to purchasing, repurchasing, redeeming, defeasing or otherwise acquiring or retiring such Subordinated Indebtedness and (ii) at a purchase price not greater than 100% of the principal amount of such Subordinated Indebtedness plus accrued and unpaid interest;
 - (b) to the extent required by the agreement governing such Subordinated Indebtedness, following the occurrence of a Change of Control (or other similar event described therein as a “change of control”), but only (i) if required, if the Issuer shall have first complied with the terms described under “Change of Control” and purchased all Notes tendered pursuant to the offer to repurchase all the Notes required thereby, prior to purchasing, repurchasing, redeeming, defeasing or otherwise acquiring or retiring such Subordinated Indebtedness and (ii) at a purchase price not greater than 101% of the principal amount of such Subordinated Indebtedness plus accrued and unpaid interest; or
 - (c) consisting of Acquired Indebtedness (other than Indebtedness Incurred (A) to provide all or any portion of the funds utilized to consummate the transaction or series of related transactions pursuant to which such Person became a Restricted Subsidiary or was otherwise acquired by Altice International or a Restricted Subsidiary or (B) otherwise in connection with or contemplation of such acquisition) and at a purchase price not greater than 100% of the principal amount of such Acquired Indebtedness plus accrued and unpaid interest and any premium required by the terms of any Acquired Indebtedness;
- (5) any dividends paid within 60 days after the date of declaration if at such date of declaration such dividend would have complied with this covenant;
- (6) the purchase, repurchase, redemption, defeasance or other acquisition, cancellation or retirement for value of Capital Stock of Altice International, any Restricted Subsidiary or any Parent (including any options, warrants or other rights in respect thereof) and loans, advances, dividends or distributions by Altice International to any Parent to permit any Parent to purchase, repurchase, redeem, defease or otherwise acquire, cancel or retire for value Capital Stock of Altice International, any Restricted Subsidiary or any Parent (including any options, warrants or other rights in respect thereof), or payments to purchase, repurchase, redeem, defease or otherwise acquire, cancel or retire for value Capital Stock of Altice International, any Restricted Subsidiary or any Parent (including any options, warrants or other rights in respect thereof), in each case from Management Investors; *provided* that such payments, loans, advances, dividends or distributions do not exceed an amount (net of repayments of any such loans or advances) equal to (1) €20 million in any calendar year (with unused amounts in any calendar year being carried over to the succeeding calendar years; *provided* that the aggregate Restricted Payments made under this clause (6) do not exceed € 20 million in any fiscal year), *plus* (2) the Net Cash Proceeds received by Altice International or the Restricted Subsidiaries since the Issue Date (including through receipt of proceeds from the issuance or sale of its Capital Stock or Subordinated Shareholder Funding to a Parent) from, or as a contribution to the equity (in each case under this clause (6), other than through the issuance of Disqualified Stock or Designated Preference Shares) of Altice International from, the issuance or sale to Management Investors of Capital Stock (including any options, warrants or other rights in respect thereof), to the extent such Net Cash Proceeds are not included in any calculation under clause (c)(ii) of the first paragraph of this covenant;
- (7) the declaration and payment of dividends to holders of any class or series of Disqualified Stock, or of any Preferred Stock of a Restricted Subsidiary, Incurred in accordance with the terms of the covenant described under “—*Limitation on Indebtedness*” above;
- (8) purchases, repurchases, redemptions, defeasances or other acquisitions or retirements of Capital Stock deemed to occur upon the exercise of stock options, warrants or other rights in respect thereof if such Capital Stock represents a portion of the exercise price thereof;
- (9) dividends, loans, advances or distributions to any Parent or other payments by Altice International or any Restricted Subsidiary in amounts equal to (without duplication) the amounts required for any Parent to pay:
- (a) any Parent Expenses or any Related Taxes; and

- (b) amounts constituting or to be used for purposes of making payments to the extent specified in clauses (2) (with respect to fees and expenses incurred in connection with the transactions described therein), (5) and (11) of the second paragraph under “—*Limitation on Affiliate Transactions;*”
- (10) so long as no Default or Event of Default has occurred and is continuing (or would result therefrom) and for so long as Altice International or any Parent is a Public Company, the declaration and payment by Altice International of, or loans, advances, dividends or distributions to any Parent to pay, dividends on the common stock or common equity interests of Altice International or any Parent, in an amount not to exceed in any fiscal year the greater of (a) 6% of the Net Cash Proceeds received by Altice International from a Public Offering (other than the Initial Public Offering) or contributed to the equity (other than through the issuance of Disqualified Stock or Designated Preference Shares or through an Excluded Contribution) of Altice International or contributed as Subordinated Shareholder Funding (other than the AI Mandatory Convertible Notes) to Altice International and (b) an amount equal to the greater of (i) 5% of the Market Capitalization and (ii) 5% of the IPO Market Capitalization; *provided* that after giving *pro forma* effect to such loans, advances, dividends or distributions, the Consolidated Net Leverage Ratio shall be equal to or less than 4.0 to 1.0; *provided, further*, that if such Public Offering was of Capital Stock of a Parent, the net proceeds of any such dividend are used to fund a corresponding dividend in equal or greater amount on the Capital Stock of such Parent;
- (11) payments by Altice International, or loans, advances, dividends or distributions to any Parent to make payments, to holders of Capital Stock of Altice International or any Parent in lieu of the issuance of fractional shares of such Capital Stock; *provided, however*, that any such payment, loan, advance, dividend or distribution shall not be for the purpose of evading any limitation of this covenant or otherwise to facilitate any dividend or other return of capital to the holders of such Capital Stock (as determined in good faith by an Officer or the Board of Directors of Altice International);
- (12) Restricted Payments in an aggregate amount outstanding at any time not to exceed the aggregate cash amount of Excluded Contributions, or consisting of non-cash Excluded Contributions, or Investments in exchange for or using as consideration Investments previously made under this clause (12);
- (13) payment of any Receivables Fees and purchases of Receivables Assets pursuant to a Receivables Repurchase Obligation in connection with a Qualified Receivables Financing;
- (14) dividends or other distributions of Capital Stock, Indebtedness or other securities of Unrestricted Subsidiaries;
- (15) so long as no Payment Block Event has occurred and is continuing, dividends or other distributions to Parent equal to the amount required by Altice S.A. for the payment of regularly scheduled interest as such amounts come due under the New ASA Notes.
- (16) the declaration and payment of dividends to holders of any class or series of Designated Preference Shares of Altice International issued after the Issue Date; *provided, however*, that the amount of all dividends declared or paid by Altice International pursuant to this clause (16) shall not exceed the Net Cash Proceeds received by Altice International from the issuance or sale of such Designated Preference Shares;
- (17) so long as no Default or Event of Default has occurred and is continuing (or would result therefrom), any Restricted Payment to the extent that, after giving *pro forma* effect to any such Restricted Payment, the Consolidated Net Leverage Ratio would be no greater than 4.0 to 1.0; and
- (18) so long as no Default or Event of Default has occurred and is continuing (or would result from), Restricted Payments in an aggregate amount outstanding at any time not to exceed the greater of €250 million and 2.0% of Total Assets.

The amount of all Restricted Payments (other than cash) shall be the fair market value on the date of such Restricted Payment of the asset(s) or securities proposed to be paid, transferred or issued by Altice International or such Restricted Subsidiary, as the case may be, pursuant to such Restricted Payment. The fair market value of any cash Restricted Payment shall be its face amount, and the fair market value of any non-cash Restricted Payment or any other property, assets or securities required to be valued by this covenant shall be determined conclusively by an Officer or the Board of Directors of Altice International acting in good faith.

For purposes of determining compliance with this covenant, in the event that a Restricted Payment meets the criteria of more than one of the categories described in clauses (1) through (18) above, or is permitted pursuant to the first paragraph of this covenant, Altice International will be entitled to classify such Restricted Payment (or portion thereof)

on the date of its payment or later reclassify such Restricted Payment (or portion thereof) in any manner that complies with this covenant.

Limitation on Liens

Altice International will not, and will not permit any of its Restricted Subsidiaries to, directly or indirectly, create, incur or suffer to exist any Lien upon any of their property or assets (including Capital Stock of a Restricted Subsidiary), whether owned on the Issue Date or acquired after that date, or any interest therein or any income or profits therefrom, which Lien is securing any Indebtedness (such Lien, the “*Initial Lien*”), except (a) in the case of any property or asset that does not constitute Notes Collateral, (i) Permitted Liens or (ii) Liens on assets that are not Permitted Liens if the Notes and the Indenture (or a Note Guarantee in the case of Liens of a Guarantor) are directly secured equally and ratably with, or prior to, in the case of Liens with respect to Subordinated Indebtedness, the Indebtedness secured by such Initial Lien for so long as such Indebtedness is so secured and (b) in the case of any property or assets that constitutes Notes Collateral, Permitted Collateral Liens.

Any such Lien created in favor of the Notes pursuant to clause (a)(ii) of the preceding paragraph will be automatically and unconditionally released and discharged upon (i) the release and discharge of the Initial Lien to which it relates, and (ii) otherwise as set forth under “—*Notes Security—Release of Note Collateral.*”

No Layering of Debt

The Issuer will not incur any Indebtedness (including any Indebtedness permitted to be incurred pursuant to the second paragraph of the covenant described under “—*Limitation on Indebtedness*”) that is contractually subordinated in right of payment to any other Indebtedness of the Issuer unless such Indebtedness is also contractually subordinated in right of payment to the Notes on substantially identical terms (as determined in good faith by the Issuer); *provided*, however, that no Indebtedness will be deemed to be contractually subordinated in right of payment to any other Indebtedness of the Issuer solely by virtue of being unsecured, by virtue of being secured with different collateral or by virtue of being secured on a junior priority basis.

No Guarantor will incur any Indebtedness (including any Indebtedness permitted to be incurred pursuant to the second paragraph of the covenant described under “—*Limitation on Indebtedness*”) that is contractually subordinated in right of payment to any Senior Indebtedness of such Guarantor and senior in right of payment to such Guarantor’s Note Guarantee; *provided*, however, that no Indebtedness will be deemed to be contractually subordinated in right of payment to any Senior Indebtedness of any Guarantor solely by virtue of being unsecured, by virtue of being secured with different collateral, by virtue of being secured on a junior priority basis or by virtue of the application of waterfall or other payment-ordering provisions affecting different tranches of Indebtedness under Credit Facilities.

Limitation on Restrictions on Distributions from Restricted Subsidiaries

Altice International will not, and will not permit any of its Restricted Subsidiaries to, create or otherwise cause or permit to exist or become effective any consensual encumbrance or consensual restriction on the ability of Altice International or any Restricted Subsidiary to:

- (A) pay dividends or make any other distributions in cash or otherwise on its Capital Stock to Altice International or any Restricted Subsidiary or pay any Indebtedness or other obligations owed to Altice International or any Restricted Subsidiary;
- (B) make any loans or advances to Altice International or any Restricted Subsidiary; or
- (C) sell, lease or transfer any of its property or assets to Altice International or any Restricted Subsidiary,

provided that (x) the priority of any Preferred Stock in receiving dividends or liquidating distributions prior to dividends or liquidating distributions being paid on common stock and (y) the subordination of (including the application of any standstill requirements to) loans or advances made to Altice International or any Restricted Subsidiary to other Indebtedness incurred by Altice International or any Restricted Subsidiary shall not be deemed to constitute such an encumbrance or restriction.

The provisions of the preceding paragraph will not prohibit:

- (1) any encumbrance or restriction pursuant to any Credit Facility or any other agreement or instrument, in each case, in effect at or entered into on the Issue Date (other than the Minority Shareholder Purchase Agreements), and any amendments, restatements, modifications, renewals, supplements, refundings, replacements or

- refinancings of such agreements; *provided* that the amendments, restatements, modifications, renewals, supplements, refundings, replacements or refinancings are not materially more restrictive, taken as a whole, with respect to such dividend and other payment restrictions than those contained in those agreements on the Issue Date (as determined in good faith by the Issuer);
- (2) the Minority Shareholder Purchase Agreements as in effect on December 12, 2012;
 - (3) encumbrances or restrictions existing under or by reason of the Indenture, the Notes, the Note Guarantees, the Senior Secured Notes Indentures, the Senior Secured Notes and the Guarantees thereof, the indenture governing the Existing ASA Notes, the Existing Senior Notes Indentures, the Existing Senior Notes and the Guarantees thereof, the Coditel Senior Credit Facility, the Coditel Intercreditor Agreement, the Intercreditor Agreement, any Additional Intercreditor Agreement, the Senior Credit Facilities, the Revolving Credit Facilities, the Existing ASA Revolving Credit Facility, the Notes Escrow Agreement, the Senior Secured Notes Escrow Agreement, the Security Documents, the Senior Secured Notes Security Documents, the HOT Proceeds Note, the Existing HOT Unsecured Notes, the HOT Security Documents, the HOT Credit Facility, the OMT Proceeds Loans and each OMT Proceeds Loans Security Document, the Finco Proceeds Loans (other than the HOT Proceeds Note) and the Proceeds Loan.
 - (4) any encumbrance or restriction pursuant to an agreement or instrument of a Person or relating to any Capital Stock or Indebtedness of a Person, entered into on or before the date on which (i) such Person was acquired by or merged, consolidated or otherwise combined with or into Altice International or any Restricted Subsidiary, (ii) such agreement or instrument is assumed by Altice International or any Restricted Subsidiary in connection with an acquisition of assets or (iii) such Person became a Restricted Subsidiary (in each case, other than Capital Stock or Indebtedness Incurred as consideration in, or to provide all or any portion of the funds utilized to consummate, the transaction or series of related transactions pursuant to which such Person became a Restricted Subsidiary or was acquired by Altice International or was merged, consolidated or otherwise combined with or into Altice International or any Restricted Subsidiary) and outstanding on such date; *provided* that, for the purposes of this clause (4), if another Person is the Successor Company (as defined under “—*Merger and Consolidation*”), or any Subsidiary thereof, any agreement or instrument of such Person or any such Subsidiary shall be deemed acquired or assumed by Altice International or any Restricted Subsidiary when such Person becomes the Successor Company;
 - (5) any encumbrance or restriction pursuant to an agreement or instrument effecting a refunding, replacement or refinancing of Indebtedness Incurred pursuant to, or that otherwise extends, renews, refunds, refinances or replaces, an agreement or instrument referred to in clause (1), (3) or (4) of this paragraph or this clause (5) (an “*Initial Agreement*”) or contained in any amendment, supplement or other modification to an agreement referred to in clause (1), (3) or (4) of this paragraph or this clause (5); *provided, however*, that the encumbrances and restrictions with respect to such Restricted Subsidiary contained in any such agreement or instrument are no less favorable in any material respect to the Holders taken as a whole than the encumbrances and restrictions contained in the Initial Agreement or Initial Agreements to which such refinancing or amendment, supplement or other modification relates (as determined in good faith by the Issuer);
 - (6) any encumbrance or restriction:
 - (a) that restricts in a customary manner the subletting, assignment or transfer of any property or asset that is subject to a lease, license or similar contract, or the assignment or transfer of any lease, license or other contract;
 - (b) contained in mortgages, pledges or other security agreements permitted under the Indenture or securing Indebtedness of Altice International or a Restricted Subsidiary permitted under the Indenture to the extent such encumbrances or restrictions restrict the transfer of the property or assets subject to such mortgages, pledges or other security agreements;
 - (c) pursuant to customary provisions restricting dispositions of real property interests set forth in any reciprocal easement agreements of Altice International or any Restricted Subsidiary; or
 - (d) pursuant to the terms of any license, authorization, concession or permit;
 - (7) any encumbrance or restriction pursuant to Purchase Money Obligations and Capitalized Lease Obligations permitted under the Indenture, in each case, that impose encumbrances or restrictions on the property so acquired or any encumbrance or restriction pursuant to a joint venture agreement that imposes restrictions on the transfer of the assets of the joint venture;

- (8) any encumbrance or restriction with respect to a Restricted Subsidiary (or any of its property or assets) imposed pursuant to an agreement entered into for the direct or indirect sale or disposition to a Person of all or substantially all the Capital Stock or assets of such Restricted Subsidiary (or the property or assets that are subject to such restriction) pending the closing of such sale or disposition;
- (9) customary provisions in leases, licenses, joint venture agreements and other similar agreements and instruments entered into in the ordinary course of business;
- (10) encumbrances or restrictions arising or existing by reason of applicable law or any applicable rule, regulation, governmental license or order, or required by any regulatory authority or stock exchange;
- (11) any encumbrance or restriction on cash or other deposits or net worth imposed by customers under agreements entered into in the ordinary course of business;
- (12) any encumbrance or restriction pursuant to Currency Agreements, Interest Rate Agreements or Commodity Hedging Agreements;
- (13) any encumbrance or restriction arising pursuant to an agreement or instrument relating to any Indebtedness permitted to be Incurred subsequent to the Issue Date pursuant to the provisions of the covenant described under “—*Limitation on Indebtedness*” if the encumbrances and restrictions contained in any such agreement or instrument taken as a whole are not materially less favorable to the Holders of the Notes than (i) the encumbrances and restrictions contained in the Revolving Credit Facilities or Senior Credit Facilities on the Issue Date, together with the security documents associated therewith, if any, and the Intercreditor Agreement as in effect on or immediately prior to the Completion Date or (ii) is customary in comparable financings (as determined in good faith by the Issuer) and where, in the case of clause (ii), the Issuer determines at the time of issuance of such Indebtedness that such encumbrances or restrictions (x) will not adversely affect, in any material respect, the Issuer’s ability to make principal or interest payments on the Notes as and when they become due or (y) such encumbrances and restrictions apply only if a default occurs in respect of a payment or financial covenant relating to such Indebtedness;
- (14) restrictions effected in connection with a Qualified Receivables Financing that, in the good faith determination of an Officer or the Board of Directors of Altice International, are necessary or advisable to effect such Qualified Receivables Financing; or
- (15) any encumbrance or restriction existing by reason of any Lien permitted under “—*Limitation on Liens*”.

Limitation on Sales of Assets and Subsidiary Stock

The Issuer will not, and will not permit the Senior Secured Notes Issuer to make any Finco Asset Sale.

Subject to the immediately preceding paragraph, Altice International will not, and will not permit any of its Restricted Subsidiaries to, make any Asset Disposition unless:

- (1) Altice International or such Restricted Subsidiary, as the case may be, receives consideration (including by way of relief from, or by any other Person assuming responsibility for, any liabilities, contingent or otherwise) at least equal to the fair market value (such fair market value to be determined on the date of contractually agreeing to such Asset Disposition), as determined in good faith by an Officer or the Board of Directors of Altice International, of the shares and assets subject to such Asset Disposition (including, for the avoidance of doubt, if such Asset Disposition is a Permitted Asset Swap); and
- (2) in any such Asset Disposition, or series of related Asset Dispositions (except to the extent the Asset Disposition is a Permitted Asset Swap), at least 75% of the consideration from such Asset Disposition or such series of related Asset Dispositions (excluding any consideration by way of relief from, or by any other Person assuming responsibility for, any liabilities, contingent or otherwise, other than Indebtedness) received by Altice International or such Restricted Subsidiary, as the case may be, is in the form of cash, Cash Equivalents or Temporary Cash Investments.

After the receipt of Net Available Cash from an Asset Disposition, Altice International or a Restricted Subsidiary, as the case may be, may apply such Net Available Cash directly or indirectly (at the option of Altice International or such Restricted Subsidiary):

- (a) (i) to prepay, repay, purchase or redeem any Senior Indebtedness within 395 days from the later of (A) the date of such Asset Disposition and (B) the receipt of such Net Available Cash; *provided, however*, that, in connection with any prepayment, repayment or purchase of Indebtedness pursuant to this clause (a)(i), Altice International or such Restricted Subsidiary will retire such Indebtedness and will cause the related commitment (if any) (except in the case of any revolving Indebtedness) to be permanently reduced in an amount equal to the principal amount so prepaid, repaid, purchased or redeemed; (ii) to prepay, repay, purchase or redeem any Pari Passu Indebtedness of the Issuer that is secured in whole or in part by a Lien on the Notes Collateral, which Lien ranks *pari passu* with the Liens securing the Notes, at a price of no more than 100% of the principal amount of such Pari Passu Indebtedness plus accrued and unpaid interest to the date of such prepayment, repayment, purchase or redemption; *provided* that the Issuer shall prepay, redeem, repay or repurchase Pari Passu Indebtedness pursuant to this clause (ii) only if the Issuer makes an offer to the holders of the Notes to purchase their Notes in accordance with the provisions set forth below for an Asset Disposition Offer for an aggregate principal amount of Notes at least equal to the proportion that (x) the total aggregate principal amount of Notes outstanding bears to (y) the sum of the total aggregate principal amount of Notes outstanding plus the total aggregate principal amount outstanding of such Pari Passu Indebtedness; (iii) to prepay, repay, purchase or redeem any Indebtedness of a Restricted Subsidiary that is not a Guarantor; (iv) to purchase the Notes pursuant to an offer to all holders of Notes at a purchase price in cash equal to at least 100% of the principal amount of the Notes, plus accrued and unpaid interest to, but not including, the date of purchase (subject to the right of Holders of record on the relevant record date to receive interest due on the relevant interest payment date); or (v) in the manner specified under sub-clause (3) of the definition of “*Change of Control*”;
- (b) to the extent Altice International or such Restricted Subsidiary elects, to invest in or purchase or commit to invest in or purchase Additional Assets (including by means of an investment in Additional Assets by a Restricted Subsidiary with Net Available Cash received by Altice International or another Restricted Subsidiary) within 395 days from the later of (i) the date of such Asset Disposition and (ii) the receipt of such Net Available Cash; *provided, however*, that any such reinvestment in Additional Assets made pursuant to a definitive binding agreement or a commitment approved by the Board of Directors of Altice International that is executed or approved within such time will satisfy this requirement, so long as such investment or commitment to invest is consummated within 180 days of such 395th day;
- (c) to make a capital expenditure within 395 days from the later of (A) the date of such Asset Disposition and (B) the receipt of such Net Available Cash; *provided, however*, that any such capital expenditure made pursuant to a definitive binding agreement or a commitment approved by the Board of Directors of Altice International that is executed or approved within such time will satisfy this requirement, so long as such investment is consummated within 180 days of such 395th day; or
- (d) any combination of the foregoing.

provided that, pending the final application of any such Net Available Cash in accordance with clause (a), (b), (c) or (d) above, Altice International and the Restricted Subsidiaries may temporarily reduce Indebtedness or otherwise invest such Net Available Cash in any manner not prohibited by the Indenture.

Any Net Available Cash from Asset Dispositions that is not applied or invested or committed to be applied or invested as provided in the preceding paragraph will be deemed to constitute “Excess Proceeds”. On the 396th day (or the 576th day, in the case of any Net Available Cash committed to be used pursuant to a definitive binding agreement or commitment approved by the Board of Directors of Altice International pursuant to clauses (b) or (c) of the third paragraph of this covenant) after the later of (A) the date of such Asset Disposition and (B) the receipt of such Net Available Cash, if the aggregate amount of Excess Proceeds exceeds €25 million, the Issuer will be required within ten (10) Business Days thereof to make an offer (“*Asset Disposition Offer*”) to all holders of Notes and, to the extent the Issuer elects or the Issuer or a Guarantor is required by the terms of other outstanding Pari Passu Indebtedness, to all holders of such other outstanding Pari Passu Indebtedness to purchase the maximum principal amount of Notes and any such Pari Passu Indebtedness to which the Asset Disposition Offer applies that may be purchased out of the Excess Proceeds, at an offer price in respect of the Notes in an amount equal to (and, in the case of any Pari Passu Indebtedness, an offer price of no more than) 100% of the principal amount of the Notes and 100% of the principal amount of Pari Passu Indebtedness, in each case, plus accrued and unpaid interest, if any, to, but not including, the date of purchase, in accordance with the procedures set forth in the Indenture or the agreements governing the Pari Passu Indebtedness, as applicable, and in the case of the Notes, in minimum denominations of \$200,000 and in integral multiples of \$1,000 in excess thereof.

To the extent that the aggregate amount of Notes and Pari Passu Indebtedness so validly tendered and not properly withdrawn pursuant to an Asset Disposition Offer is less than the Excess Proceeds, the Issuer, the Senior Secured Notes Issuer, Altice International and the Restricted Subsidiaries may use any remaining Excess Proceeds for general corporate purposes, to the extent not prohibited by the other covenants contained in the Indenture. If the aggregate principal amount of the Notes surrendered in any Asset Disposition Offer by Holders and other Pari Passu Indebtedness surrendered by

holders or lenders, collectively, exceeds the amount of Excess Proceeds, the Excess Proceeds shall be allocated among the Notes and Pari Passu Indebtedness to be purchased on a *pro rata* basis on the basis of the aggregate principal amount of tendered Notes and Pari Passu Indebtedness. For the purposes of calculating the principal amount of any such Indebtedness not denominated in euro, such Indebtedness shall be calculated by converting any such principal amounts into their Euro Equivalent determined as of a date selected by the Issuer that is within the Asset Disposition Offer Period (as defined below). Upon completion of any Asset Disposition Offer, the amount of Excess Proceeds shall be reset at zero.

To the extent that any portion of Net Available Cash payable in respect of the Notes is denominated in a currency other than the currency in which the relevant Notes are denominated, the amount thereof payable in respect of such Notes shall not exceed the net amount of funds in the currency in which such Notes are denominated that is actually received by the Issuer upon converting such portion of the Net Available Cash into such currency.

The Asset Disposition Offer, in so far as it relates to the Notes, will remain open for a period of not less than 20 Business Days following its commencement (the "Asset Disposition Offer Period"). No later than five (5) Business Days after the termination of the Asset Disposition Offer Period (the "Asset Disposition Purchase Date"), the Issuer will purchase the principal amount of Notes and, to the extent it elects, Pari Passu Indebtedness required to be purchased by it pursuant to this covenant (the "Asset Disposition Offer Amount") or, if less than the Asset Disposition Offer Amount has been so validly tendered, all Notes and Pari Passu Indebtedness validly tendered in response to the Asset Disposition Offer.

On or before the Asset Disposition Purchase Date, the Issuer will, to the extent lawful, accept for payment, on a *pro rata* basis to the extent necessary, the Asset Disposition Offer Amount of Notes and Pari Passu Indebtedness or portions of Notes and Pari Passu Indebtedness so validly tendered and not properly withdrawn pursuant to the Asset Disposition Offer, or if less than the Asset Disposition Offer Amount has been validly tendered and not properly withdrawn, all Notes and Pari Passu Indebtedness so validly tendered and not properly withdrawn and, in the case of the Notes, in minimum denominations of \$200,000 and in integral multiples of \$1,000 in excess thereof. The Issuer will deliver to the Trustee an Officer's Certificate stating that such Notes or portions thereof were accepted for payment by the Issuer in accordance with the terms of this covenant. The Issuer or the Paying Agent, as the case may be, will promptly (but in any case not later than five (5) Business Days after termination of the Asset Disposition Offer Period) mail or deliver to each tendering Holder of Notes an amount equal to the purchase price of the Notes so validly tendered and not properly withdrawn by such Holder, and accepted by the Issuer for purchase, and the Issuer will promptly issue a new Note (or amend the applicable Global Note), and the Trustee, upon delivery of an Officer's Certificate from the Issuer, will, via an authenticating agent, authenticate and mail or deliver (or cause to be transferred by book-entry) such new Note to such Holder, in a principal amount equal to any unpurchased portion of the Note surrendered; *provided* that each such new Note will be in a principal amount with a minimum denomination of \$200,000. Any Note not so accepted will be promptly mailed or delivered (or transferred by book-entry) by the Issuer to the Holder thereof.

For the purposes of clause (2) of the first paragraph of this covenant, the following will be deemed to be cash:

- (1) the assumption by the transferee of Indebtedness of Altice International or any Restricted Subsidiary (other than Subordinated Indebtedness of the Issuer or a Guarantor) and the release of Altice International or such Restricted Subsidiary from all liability on such Indebtedness in connection with such Asset Disposition;
- (2) securities, notes or other obligations received by Altice International or any Restricted Subsidiary from the transferee that are converted by Altice International or such Restricted Subsidiary into cash or Cash Equivalents within 180 days following the closing of such Asset Disposition, to the extent of the cash received;
- (3) Indebtedness of any Restricted Subsidiary that is no longer a Restricted Subsidiary as a result of such Asset Disposition, to the extent that Altice International and each other Restricted Subsidiary (as applicable) are released from any Guarantee of payment of such Indebtedness in connection with such Asset Disposition;
- (4) consideration consisting of Indebtedness of the Issuer or a Guarantor (other than Subordinated Indebtedness) received after the Issue Date from Persons who are not Altice International or any Restricted Subsidiary; and
- (5) any Designated Non-Cash Consideration received by Altice International or any Restricted Subsidiary in such Asset Dispositions having an aggregate fair market value, taken together with all other Designated Non-Cash Consideration received pursuant to this covenant that is at that time outstanding, not to exceed the greater of €185 million and 1.5% of Total Assets (with the fair market value of each item of Designated Non-Cash Consideration being measured at the time received and without giving effect to subsequent changes in value).

The Issuer will comply, to the extent applicable, with the requirements of Section 14(e) of the Exchange Act and any other securities laws or regulations in connection with the repurchase of Notes pursuant to the Indenture. To the extent that the provisions of any securities laws or regulations conflict with provisions of this covenant, the Issuer will comply

with the applicable securities laws and regulations and will not be deemed to have breached its obligations under the Indenture by virtue of any conflict.

Limitation on Affiliate Transactions

Altice International will not, and will not permit any of its Restricted Subsidiaries to, directly or indirectly, enter into or conduct any transaction or series of related transactions (including the purchase, sale, lease or exchange of any property or the rendering of any service) with any Affiliate of Altice International (any such transaction or series of related transactions being “Affiliate Transactions”) involving aggregate value in excess of €5 million unless:

- (1) the terms of such Affiliate Transaction taken as a whole are not materially less favorable to Altice International or such Restricted Subsidiary, as the case may be, than those that could be obtained in a comparable transaction at the time of such transaction or the execution of the agreement providing for such transaction in arm’s-length dealings with a Person who is not such an Affiliate; and
- (2) in the event such Affiliate Transaction involves an aggregate value in excess of €25 million, the terms of such transaction or series of related transactions have been approved by a resolution of the majority of the members of the Board of Directors of Altice International resolving that such transaction complies with clause (1) above; *provided* that an Affiliate Transaction shall be deemed to have satisfied the requirements set forth in this clause (2) of this paragraph if such Affiliate Transaction is approved by a majority of the Disinterested Directors. If there are no Disinterested Directors, any Affiliate Transaction shall also be deemed to have satisfied the requirements set forth in this covenant if Altice International or any of its Restrictions Subsidiaries, as the case may be, delivers to the Trustee a letter from an Independent Financial Advisor stating that such transaction is fair to Altice International or such Restricted Subsidiary from a financial point of view or stating that the terms are not materially less favorable to Altice International or its relevant Restricted Subsidiary than those that would have been obtained in a comparable transaction by Altice International or such Restricted Subsidiary with an unrelated Person on arm’s length basis.

The provisions of the preceding paragraph will not apply to:

- (1) any Restricted Payment permitted to be made pursuant to the covenant described under “—*Limitation on Restricted Payments*”, any Permitted Payments (other than pursuant to clause (9)(b) of the third paragraph of the covenant described under “—*Limitation on Restricted Payments*”) or any Permitted Investment (other than Permitted Investments as defined in paragraphs (1)(b), (2) and (17) of the definition thereof);
- (2) any issuance or sale of Capital Stock, options, other equity-related interests or other securities, or other payments, awards or grants in cash, securities or otherwise pursuant to, or the funding of, or entering into, or maintenance of, any employment, consulting, collective bargaining or benefit plan, program, agreement or arrangement, related trust or other similar agreement and other compensation arrangements, options, warrants or other rights to purchase Capital Stock of Altice International, any Restricted Subsidiary or any Parent, restricted stock plans, long-term incentive plans, stock appreciation rights plans, participation plans or similar employee benefits or consultants’ plans (including valuation, health, insurance, deferred compensation, severance, retirement, savings or similar plans, programs or arrangements) or indemnities provided on behalf of officers, employees, directors or consultants approved by the Board of Directors of Altice International, in each case in the ordinary course of business;
- (3) any Management Advances and any waiver or transaction with respect thereto;
- (4) any transaction between or among Altice International and any Restricted Subsidiary (or entity that becomes a Restricted Subsidiary as a result of such transaction), or between or among Altice International, Restricted Subsidiaries or any Receivables Subsidiary;
- (5) the payment of reasonable fees and reimbursement of expenses to, and customary indemnities and employee benefit and pension expenses provided on behalf of, directors, officers, consultants or employees of Altice International, any Restricted Subsidiary or any Parent (whether directly or indirectly and including through any Person owned or controlled by any of such directors, officers or employees);
- (6) the Transactions and the entry into and performance of obligations of Altice International or any of its Restricted Subsidiaries under the terms of any transaction arising out of, and any payments pursuant to or for purposes of funding, any agreement or instrument in effect as of or on the Issue Date, as these agreements and instruments may be amended, modified, supplemented, extended, renewed or refinanced from time to time (including, without limitation, to add additional Persons in connection with any such Person becoming a Restricted Subsidiary) in accordance with the other terms of this covenant or to the extent not more disadvantageous to the

Holders in any material respect and the entry into and performance of any registration rights or other listing agreement in connection with any Public Offering (including the Initial Public Offering);

- (7) execution, delivery and performance of any Tax Sharing Agreement or the formation and maintenance of any consolidated group for tax, accounting or management purposes in the ordinary course of business;
- (8) transactions with customers, clients, suppliers or purchasers or sellers of goods or services and Associates, in each case in the ordinary course of business (including, without limitation, pursuant to joint venture arrangements), which are fair to Altice International or the relevant Restricted Subsidiary in the reasonable determination of the Board of Directors or an officer of Altice International or the relevant Restricted Subsidiary, or are on terms no less favorable than those that could reasonably have been obtained at such time from an unaffiliated party;
- (9) any transaction in the ordinary course of business between or among Altice International or any Restricted Subsidiary and any Affiliate of Altice International or an Associate or similar entity (in each case, other than an Unrestricted Subsidiary) that would constitute an Affiliate Transaction solely because Altice International or a Restricted Subsidiary or any Affiliate of Altice International or a Restricted Subsidiary or any Affiliate of any Permitted Holder owns an equity interest in or otherwise controls such Affiliate, Associate or similar entity;
- (10) (a) issuances or sales of Capital Stock (other than Disqualified Stock or Designated Preference Shares) of Altice International or options, warrants or other rights to acquire such Capital Stock or Subordinated Shareholder Funding; *provided* that the interest rate and other financial terms of such Subordinated Shareholder Funding are approved by a majority of the members of the Board of Directors of Altice International in their reasonable determination and (b) any amendment, waiver or other transaction with respect to any Subordinated Shareholder Funding in compliance with the other provisions of the Indenture, the Intercreditor Agreement or any Additional Intercreditor Agreement, as applicable;
- (11) without duplication in respect of payments made pursuant to the definition of Parent Expenses, (a) payments by Altice International or any Restricted Subsidiary to any Permitted Holder (whether directly or indirectly, including through any Parent) of annual management, consulting, monitoring or advisory fees and related expenses in an aggregate amount not to exceed an amount equal to the greater of €20 million or 1.0% of Consolidated EBITDA (as reported by Altice International in the financial statements delivered pursuant to clause (1) of the covenant under “*Reports*” for the most recent fiscal year ended prior to the date of determination) per year; (b) customary payments by Altice International or any Restricted Subsidiary to any Permitted Holder (whether directly or indirectly, including through any Parent) for financial advisory, financing, underwriting or placement services or in respect of other investment banking activities, including in connection with acquisitions or divestitures, which payments in respect of this clause (b) are approved by a majority of the Board of Directors of Altice International in good faith; and (c) payments of all fees and expenses related to the Transactions;
- (12) any transaction effected as part of a Qualified Receivables Financing; and
- (13) any participation in a rights offer or public tender or exchange offers for securities or debt instruments issued by Altice International or any of its Subsidiaries that are conducted on arm’s length terms and provide for the same price or exchange ratio, as the case may be, to all holders accepting such rights, tender or exchange offer.

Maintenance of Listing

The Issuer will use its commercially reasonable efforts to maintain the listing of the Notes on the Official List of the Luxembourg Stock Exchange and the admission to trading on its Euro MTF Market for so long as such Notes are outstanding; *provided* that if at any time the Issuer determines that it will not maintain such listing, it will obtain prior to the delisting of the Notes from the Euro MTF Market of the Luxembourg Stock Exchange, and thereafter use its best efforts to maintain, a listing of such Notes on another recognized stock exchange.

Reports

For so long as any Notes are outstanding, Altice International will provide to the Trustee the following reports:

- (1) within 120 days after the end of Altice International’s fiscal year beginning with the fiscal year ending December 31, 2014, annual reports containing, to the extent applicable, and in a level of detail that is comparable in all material respects to the annual report of Altice International for the year ended December 31, 2013, the following information: audited consolidated balance sheet of Altice International as of the end of the most recent fiscal year (and comparative information as of the end of the prior fiscal year) and audited

consolidated income statements and statements of cash flow of Altice International for the most recent fiscal year (and comparative information as of the end of the prior fiscal year), including complete footnotes to such financial statements and the report of the independent auditors on the financial statements (*provided* that for any fiscal year ended prior to the Issue Date, Altice International can provide *pro forma* or aggregated financial statements prepared on a basis consistent with the *pro forma* information contained in “Pro Forma” section of this Offering Memorandum to meet the requirements set forth above); unaudited *pro forma* income statement information and balance sheet information of Altice International (which, for the avoidance of doubt, shall not include the provision of a full income statement or balance sheet to the extent not reasonably available), together with explanatory footnotes, for (i) any acquisition or disposition by Altice International or a Restricted Subsidiary that, individually or in the aggregate when considered with all other acquisitions or dispositions that have occurred since the beginning of the most recently completed fiscal year as to which such annual report relates, represent greater than 20% of the consolidated revenues, EBITDA, or assets of Altice International on a *pro forma* consolidated basis or (ii) recapitalizations by Altice International or a Restricted Subsidiary, in each case, that have occurred since the beginning of the most recently completed fiscal year (unless such *pro forma* information has been provided in a prior report pursuant to clause (2) or (3) below); (c) an operating and financial review of the audited financial statements, including a discussion of the results of operations, financial condition, and liquidity and capital resources of Altice International, and a discussion of material commitments and contingencies and critical accounting policies; (d) description of the business, management and shareholders of Altice International, all material affiliate transactions and a description of all material contractual arrangements, including material debt instruments; and (e) a description of material risk factors and material recent developments (to the extent not previously reported pursuant to clause (2) or (3) below).

- (2) within 60 days following the end of the first three fiscal quarters in each fiscal year of Altice International beginning with the fiscal quarter ending March 31, 2015 (*provided* that, if the Completion Date occurs in any such fiscal quarter, the foregoing reference to 60 days shall be deemed to be 90 days for such fiscal quarter), all quarterly reports of Altice International containing the following information in a level of detail comparable in all material respects to the quarterly report of Altice International for the nine months ended September 30, 2014: (a) an unaudited condensed consolidated balance sheet as of the end of such quarter and unaudited condensed consolidated statements of income and cash flow for the most recent quarter year-to-date period ending on the date of the unaudited condensed balance sheet, and the comparable prior year periods, together with condensed footnote disclosure; (b) unaudited *pro forma* income statement information and balance sheet information (which, for the avoidance of doubt, shall not include the provision of a full income statement or balance sheet to the extent not reasonably available), together with explanatory footnotes, for any acquisition or disposition by Altice International or a Restricted Subsidiary that, individually or in the aggregate when considered with all other acquisitions or dispositions that have occurred since the beginning of the relevant quarter, represent greater than 20% of the consolidated revenues, EBITDA, or assets of Altice International on a *pro forma* consolidated basis (unless such *pro forma* information has been provided in a prior report pursuant to clause (3) below); (c) a summary operating and financial review of the unaudited financial statements, including a discussion of revenues, EBITDA, capital expenditures, operating cash flow, and material changes in liquidity and capital resources, and a discussion of material changes not in the ordinary course of business in commitments and contingencies since the most recent report; and (d) material recent developments (to the extent not previously reported pursuant to clause (3) below); and
- (3) promptly after the occurrence of such event, information with respect to (a) any change in the independent public accountants of Altice International, (b) any material acquisition, disposal, merger or similar transaction or (c) any development determined by an Officer of Altice International to be material to the business of Altice International and its Restricted Subsidiaries (taken as a whole).

All financial statement information shall be prepared in accordance with IFRS as in effect on the date of such report or financial statement (or otherwise on the basis of IFRS as then in effect) and on a consistent basis for the periods presented; *provided, however*, that the reports set forth in clauses (1), (2) and (3) above may in the event of a change in IFRS, present earlier periods on a basis that applied to such periods. Except as provided for above, no report need include separate financial statements for Altice International or Subsidiaries of Altice International or any disclosure with respect to the results of operations or any other financial or statistical disclosure not of a type included in the Offering Memorandum and in no event shall U.S. GAAP information or reconciliation to U.S. GAAP be required.

At any time if any Subsidiary of Altice International is an Unrestricted Subsidiary and any such Unrestricted Subsidiary or group of Unrestricted Subsidiaries, if taken together as one Subsidiary, constitutes a Significant Subsidiary, then the quarterly and annual financial information required by the first paragraph of this covenant will include a reasonably detailed presentation, either on the face of the financial statements or in the footnotes thereto, of the financial condition and results of operations of Altice International and its Restricted Subsidiaries separate from the financial condition and results of operations of the Unrestricted Subsidiaries of Altice International.

Substantially concurrently with the issuance to the Trustee of the reports specified in (1), (2) and (3) of the first paragraph of this covenant, Altice International shall also (a) use its commercially reasonable efforts (i) to post copies of such reports on such website as may be then maintained by the Issuer, Altice International and its Subsidiaries or (ii) otherwise to provide substantially comparable public availability of such reports (as determined by Altice International in good faith) or (b) to the extent Altice International determines in good faith that such reports cannot be made available in the manner described in the preceding clause (a) owing to applicable law or after the use of its commercially reasonable efforts, furnish such reports to the Holders and, upon their request, prospective purchasers of the Notes. Altice International will also make available copies of all reports required by clauses (1) through (3) of the first paragraph of this covenant, if and so long as the Notes are listed on the Euro MTF Market of the Luxembourg Stock Exchange and the rules of the Luxembourg Stock Exchange so require, at the Issuer's registered office in Luxembourg or, to the extent and in the manner permitted by such rules, post such reports on the official website of the Luxembourg Stock Exchange (www.bourse.lu).

In addition, so long as the Notes remain outstanding and during any period during which the Issuer is not subject to Section 13 or 15(d) of the Exchange Act nor exempt therefrom pursuant to Rule 12g3-2(b), the Issuer shall furnish to the Holders and holders of beneficial interests in the Notes and, upon their request, prospective purchasers of the Notes or prospective and purchasers of beneficial interests in the Notes, the information required to be delivered pursuant to Rule 144A(d)(4) under the Securities Act.

Merger and Consolidation

The Issuer

The Issuer will not directly or indirectly: (1) consolidate or merge with or into another Person (whether or not the Issuer is the surviving corporation) or (2) sell, assign, transfer, lease, convey or otherwise dispose of all or substantially all of the properties or assets of the Issuer taken as a whole in one or more related transactions, to another Person.

Senior Secured Notes Issuer

The Senior Secured Notes Issuer will not directly or indirectly: (1) consolidate or merge with or into another Person (whether or not the Senior Secured Notes Issuer is the surviving corporation) or (2) sell, assign, transfer, lease, convey or otherwise dispose of all or substantially all of the properties or assets of the Senior Secured Notes Issuer taken as a whole in one or more related transactions, to another Person.

Altice International

Altice International will not consolidate with or merge with or into, or assign, convey, transfer, lease or otherwise dispose of all or substantially all its assets as an entirety or substantially as an entirety, in one transaction or a series of related transactions to, any Person, unless:

- (1) the resulting, surviving or transferee Person (the "Successor Company") (if not Altice International) will be a Person organized and existing under the laws of any member state of the European Union, Switzerland, Canada, the State of Israel or the United States of America, any State of the United States or the District of Columbia and the Successor Company (if not Altice International) will expressly assume, (a) by supplemental indenture, executed and delivered to the Trustee, in form reasonably satisfactory to the Trustee, all the obligations of Altice International under the Notes and the Indenture and (b) all obligations of Altice International under the Intercreditor Agreement and the Security Documents, as applicable;
- (2) immediately after giving effect to such transaction (and treating any Indebtedness that becomes an obligation of the Successor Company or any Subsidiary of the Successor Company as a result of such transaction as having been Incurred by the Successor Company or such Subsidiary at the time of such transaction), no Default or Event of Default shall have occurred and be continuing;
- (3) immediately after giving *pro forma* effect to such transaction and any related financing transactions, as if such transactions had occurred at the beginning of applicable four-quarter period, either (a) the Successor Company would be able to Incur at least an additional €1.00 of Indebtedness pursuant to the first paragraph of the covenant described under "*—Limitation on Indebtedness*" or (b) the Consolidated Net Leverage Ratio would not be greater than it was immediately prior to giving effect to such transaction; and
- (4) the Issuer shall have delivered to the Trustee an Officer's Certificate and an Opinion of Counsel, each to the effect that such consolidation, merger or transfer and such supplemental indenture (if any) comply with the Indenture and an Opinion of Counsel to the effect that such supplemental indenture (if any) has been duly authorized, executed and delivered and is a legal, valid and binding agreement enforceable against the Successor

Company (in each case, in form and substance reasonably satisfactory to the Trustee); *provided* that in giving an Opinion of Counsel, counsel may rely on an Officer's Certificate as to any matters of fact.

Subject to the last paragraph of the covenant "*Merger and Consolidation—The Subsidiary Guarantors*", for purposes of this covenant, the sale, lease, conveyance, assignment, transfer, or other disposition of all or substantially all of the properties and assets of one or more Subsidiaries of Altice International, which properties and assets, if held by Altice International instead of such Subsidiaries, would constitute all or substantially all of the properties and assets of Altice International on a consolidated basis, shall be deemed to be the transfer of all or substantially all of the properties and assets of Altice International.

The Successor Company will succeed to, and be substituted for, and may exercise every right and power of, Altice International under the Indenture but in the case of a lease of all or substantially all its assets, the predecessor company will not be released from its obligations under the Indenture or the Notes.

Notwithstanding the preceding clauses (2) and (3) (which do not apply to transactions referred to in this sentence) and clause (4) of the second paragraph of this covenant (which does not apply to transactions referred to in this sentence in which Altice International is the Successor Company), (a) any Restricted Subsidiary may consolidate or otherwise combine with, merge into or transfer all or part of its properties and assets to Altice International (so long as Altice International is a Guarantor); and (b) any Restricted Subsidiary that is not a Guarantor may consolidate or otherwise combine with, merge into or transfer all or part of its properties and assets to any other Restricted Subsidiary or Altice International. Notwithstanding the preceding clause (3) (which does not apply to the transactions referred to in this sentence) of the second paragraph of this covenant, Altice International may consolidate or otherwise combine with or merge into an Affiliate incorporated or organized for the purpose of changing the legal domicile of Altice International, reincorporating Altice International in another jurisdiction or changing the legal form of Altice International.

There is no precise established definition of the phrase "substantially all" under applicable law. Accordingly, in certain circumstances there may be a degree of uncertainty as to whether a particular transaction would involve "all or substantially all" of the property or assets of a Person.

The foregoing provisions (other than the requirements of clause (2) of the second paragraph of this "Merger and Consolidation" covenant) shall not apply to the creation of a new Subsidiary as a Restricted Subsidiary.

The Subsidiary Guarantors

None of the Subsidiary Guarantors (other than the Senior Secured Notes Issuer and a Guarantor whose Note Guarantee is to be released in accordance with the terms of the Indenture or the Intercreditor Agreement) may:

- (1) consolidate with or merge with or into any Person (whether or not such Guarantor is the surviving Person);
- (2) sell, assign, convey, transfer, lease or otherwise dispose of, all or substantially all its assets as an entirety or substantially as an entirety, in one transaction or a series of related transactions, to any Person; or
- (3) permit any Person to merge with or into it;

unless:

- (A) the other Person is Altice International or a Restricted Subsidiary that is a Guarantor or becomes a Guarantor as a result of such transaction; or
- (B) (1) either (x) a Guarantor is the surviving Person or (y) the resulting, surviving or transferee Person expressly assumes all of the obligations of the Guarantor under its Note Guarantee and the Indenture (pursuant to a supplemental indenture executed and delivered in a form reasonably satisfactory to the Trustee) and all obligations of the Guarantor under the Intercreditor Agreement and Security Documents, as applicable; and
(2) immediately after giving effect to the transaction, no Default or Event of Default shall have occurred and is continuing; or
- (C) the transaction constitutes a sale or other disposition (including by way of consolidation or merger) of a Guarantor or the sale or disposition of all or substantially all the assets of a Guarantor (in each case other than to Altice International or a Restricted Subsidiary) otherwise permitted by the Indenture and the proceeds therefrom are applied as required by the Indenture.

Notwithstanding the preceding clause (B)(2) (which does not apply to transactions referred to in this sentence), (a) any Restricted Subsidiary may consolidate or otherwise combine with, merge into or transfer all or part of its properties and assets to a Guarantor and (b) any Guarantor may consolidate or otherwise combine with, merge into or transfer all or part of its properties and assets to any other Guarantor. Notwithstanding the preceding clause (B)(2) (which does not apply to the transactions referred to in this sentence), a Guarantor may consolidate or otherwise combine with or merge into an Affiliate incorporated or organized for the purpose of changing the legal domicile of the Guarantor reincorporating the Guarantor in another jurisdiction, or changing the legal form of the Guarantor.

There is no precise established definition of the phrase “substantially all” under applicable law. Accordingly, in certain circumstances there may be a degree of uncertainty as to whether a particular transaction would involve “all or substantially all” of the property or assets of a Person.

The provisions under this covenant “*Merger and Consolidation—Altice International*” and “*Merger and Consolidation—The Subsidiary Guarantors*” shall not apply to (1) any sale, lease, transfer, conveyance or other disposition in one or a series of related transactions of any assets of Altice International and its Subsidiaries or the Target and its Subsidiaries (including the Capital Stock of the Target or any Subsidiary of Altice International or the Target) that is required pursuant to Competition Laws in relation to the Acquisition or is taken to avoid or eliminate any impediment under Competition Laws in relation to the Acquisition (including, without limitation, in response to any actions initiated by an administrative, regulatory or other governmental authority or private party under Competition Laws); *provided that*, solely to the extent Altice International is relying on the foregoing exception, in the event the fair market value of any such sold, leased, transferred, conveyed or disposed of assets exceeds 2.0% of the Total Assets (on a pro forma consolidated basis, including, without limitation, the Target and its Subsidiaries that are Restricted Subsidiaries), (i) the Consolidated Net Leverage Ratio of Altice International and its Restricted Subsidiaries (on a pro forma consolidated basis, including, without limitation, the Target and its Subsidiaries that are Restricted Subsidiaries) shall not increase; and (ii) Altice International shall promptly make an offer to all holders of the Existing Term Loans and, to the extent required by the terms of any Pari Passu Indebtedness that is not Public Debt, any such Pari Passu Indebtedness to repay or repurchase such Existing Term Loans and Pari Passu Indebtedness at a price of 100% of the principal amount thereof plus accrued and unpaid interest thereon to the date of redemption in an amount equal to the Net Cash Proceeds of such sale, lease, transfer, conveyance or other disposition (on a *pro rata* basis on the basis of the aggregate principal amount of tendered Existing Term Loans and Pari Passu Indebtedness) and in the event the principal amount of such Pari Passu Indebtedness tendered is less than the amount of such Net Cash Proceeds, Altice International shall apply any such remaining proceeds to prepay an equal principal amount of Existing Term Loans at par on a pro rata basis. There is no precise established definition of the phrase “substantially all” under applicable law. Accordingly, in certain circumstances there may be a degree of uncertainty as to whether a particular transaction would involve “all or substantially all” of the property or assets of a Person.

Limitation on Issuer and Senior Secured Notes Issuer Activities

Notwithstanding anything contained in the Indenture:

- (1) The Issuer will not, and will not permit the Senior Secured Notes Issuer to, engage in any business activity or undertake any other activity, except any such activity:
 - (a) reasonably relating to the offering, sale, issuance, Incurrence, servicing, purchase, redemption, amendment, exchange, refinancing or retirement of or Investment in the Notes, the Existing Senior Notes, the Senior Secured Notes, the Senior Credit Facilities, the Revolving Credit Facilities, the Guarantee Facility any Additional Notes or other Indebtedness (including any Refinancing Indebtedness in respect of any of the foregoing) permitted to be Incurred by the terms of the Indenture, the Existing Senior Notes Indenture or the Senior Secured Notes Indentures (including the lending, directly or indirectly, of the proceeds of such sale of the Notes, the Senior Secured Notes any Additional Notes or other Indebtedness permitted by the terms of the Indenture, the Existing Senior Notes Indenture or the Senior Secured Notes Indentures pursuant to the Finco Proceeds Loans and the Proceeds Loan or borrowing directly or indirectly from Altice International or any Restricted Subsidiary);
 - (b) undertaken with the purpose of, directly or indirectly, fulfilling its obligations or exercising its rights under the Notes, the Existing Senior Notes, the Senior Secured Notes, the Senior Credit Facilities, the Revolving Credit Facilities, the Guarantee Facility, any Additional Notes, the Finco Proceeds Loans, the Proceeds Loan, any Additional Notes or other Indebtedness, Hedging Obligations or any other obligations (including any Refinancing Indebtedness in respect of any of the foregoing), in each case, permitted to be Incurred by the terms of the Indenture, the Senior Secured Indentures, the New Senior Secured Notes Indenture, the Existing Senior Notes Indentures, any Security Document or Senior Secured Notes Security Document to which it is a party, the Intercreditor Agreement (or any Additional

Intercreditor Agreement entered into pursuant to the terms of the Intercreditor Agreement or the Indenture) or the Notes Escrow Agreement;

- (c) directly related or reasonably incidental to the establishment and/or maintenance of the Issuer's and Senior Secured Notes Issuer's corporate existence, the acquisition, holding or disposition of assets permitted to be held by it under the Indenture, the Existing Senior Notes Indenture, or the Senior Secured Notes Indentures, as the case may be;
 - (d) directly related to investing amounts received by the Issuer (other than amounts not corresponding to required payments under the Notes) or the Senior Secured Notes Issuer (other than amounts not corresponding to required payments under the Senior Secured Notes) in such manner not otherwise prohibited by the Indenture, the Existing Senior Notes Indenture, or the Senior Secured Notes Indentures, as the case may be;
 - (e) in the case of the Issuer, making Permitted Issuer Investments and Incurring Permitted Issuer Liens and, in the case of the Senior Secured Notes Issuer, making Permitted Senior Secured Notes Issuer Investments and Incurring Permitted Senior Secured Notes Issuer Liens;
 - (f) in the case of the Senior Secured Notes Issuer, related to cash management activities on behalf of the Issuer, Altice International and the Restricted Subsidiaries; or
 - (g) (i) any transaction or activity not to exceed €5 million in the aggregate and (ii) other activities not specifically enumerated above that are immaterial in nature.
- (2) The Issuer shall not:
- (a) issue any Capital Stock (other than to Altice International);
 - (b) take any action which would cause it to no longer satisfy the requirements of an available exemption from the provisions of the U.S. Investment Company Act of 1940, as amended;
 - (c) commence or take any action or facilitate a winding-up, liquidation, dissolution or other analogous proceeding;
 - (d) amend its constitutive documents in any manner which would adversely affect the rights of Holders in any material respect;
 - (e) transfer or assign the Proceeds Loan (or rights thereunder) except pursuant to the Security Documents; or
 - (f) amend any provision of, or waive any default or event of default under, any Proceeds Loan except in accordance with "*—Amendments and Waivers*".
- (3) The Senior Secured Notes Issuer shall not:
- (a) issue any Capital Stock (other than to the Issuer);
 - (b) take any action which would cause it to no longer satisfy the requirements of an available exemption from the provisions of the U.S. Investment Company Act of 1940, as amended;
 - (c) commence or take any action or facilitate a winding-up, liquidation, dissolution or other analogous proceeding;
 - (d) amend its constitutive documents in any manner which would adversely affect the rights of Holders in any material respect;
 - (e) transfer or assign any Finco Proceeds Loan (or rights thereunder) except pursuant to the Security Documents; or
 - (f) amend any Finco Proceeds Loan except in accordance with "*—Amendments and Waivers*" provisions of the Senior Secured Notes Indentures;

- (4) Except as otherwise provided in the Indenture, the Issuer will take all actions necessary and within its power to prohibit the transfer of the issued ordinary shares and management share in the Issuer by Altice International, other than pursuant to the Issuer Share Pledge or the enforcement of such Issuer Share Pledge.
- (5) Whenever the Issuer receives a payment or prepayment under any Proceeds Loan, it shall use the funds received solely to satisfy its obligations (to the extent of the amount owing in respect of such obligations) under the Indenture (including any premium paid to holders of the Notes) or any other Indebtedness of the Issuer.
- (6) Whenever the Senior Secured Notes Issuer receives a payment or prepayment under a Finco Proceeds Loan, it shall use the funds received solely to satisfy its obligations (to the extent of the amount owing in respect of such obligations) under the Senior Secured Notes Indentures (including any premium paid to holders of the Senior Secured Notes) or any other Indebtedness of the Senior Secured Notes Issuer (including Indebtedness under any Proceeds Loans); *provided* that to the extent the Senior Secured Notes Issuer receives cash payment in respect of interest on a Finco Proceeds Loan previously paid in-kind and the amount of such cash payment exceeds the obligations of the Senior Secured Notes Issuer then due and payable (or due and payable within five Business Days of such receipt) under the Senior Secured Notes, the New Senior Secured Notes, the Proceeds Loan or any other Indebtedness of the Senior Secured Notes Issuer, the Senior Secured Notes Issuer may use such excess amount for any purpose not prohibited by the Indenture.

Lines of Business

Altice International will not, and will not permit any of its Restricted Subsidiaries to, engage in any business other than a Similar Business, except to such extent as would not be material to Altice International and the Restricted Subsidiaries, taken as a whole.

Additional Guarantors

Altice International will not permit any of its Restricted Subsidiaries (other than a Guarantor) to Guarantee any Indebtedness of the Issuer or any Guarantor (other than Indebtedness Incurred under clause (8) of the second paragraph of the covenant described under “—*Limitation on Indebtedness*”, except Indebtedness Incurred under Credit Facilities or Public Debt pursuant to such clause (8)) unless such Restricted Subsidiary is or becomes a Guarantor on the date on which the Guarantee is Incurred and, if applicable, executes and delivers to the Trustee a supplemental indenture in the form attached to the Indenture pursuant to which such Restricted Subsidiary will provide a Note Guarantee, which Guarantee will be subordinated to Senior Indebtedness of such Restricted Subsidiary and senior to or *pari passu* with such Restricted Subsidiary’s Guarantee of such other Indebtedness.

Note Guarantees granted after the Issue Date pursuant to this covenant shall be released as set forth under “—*Releases of the Note Guarantees*”. Note Guarantees granted after the Issue Date pursuant to the first paragraph of this covenant may be released at the option of the Issuer if, at the date of such release, (i) the Indebtedness which required such Note Guarantee has been released or discharged in full, (ii) no Event of Default would arise as a result of such release, and (iii) there is no other Indebtedness of such Guarantor outstanding that was Incurred after the Issue Date and that could not have been Incurred in compliance with the Indenture as of the date Incurred if such Guarantor were not a Guarantor as at that date. The Trustee and the Security Agent (to the extent action is required by it) shall each take all necessary actions requested by the Issuer, including the granting of releases or waivers under the Intercreditor Agreement or any Additional Intercreditor Agreement, to effectuate any release of a Note Guarantee in accordance with these provisions, subject to customary protections and indemnifications.

Each additional Note Guarantee will be limited as necessary to recognize certain defenses generally available to guarantors (including those that relate to fraudulent conveyance or transfer, voidable preference, financial assistance, corporate purpose, thin capitalization, distributable reserves, capital maintenance or similar laws, regulations or defenses affecting the rights of creditors generally) or other considerations under applicable law.

Notwithstanding the foregoing, Altice International shall not be obligated to cause such Restricted Subsidiary to become a Guarantor to the extent and for so long as the Incurrence of such Guarantee could reasonably be expected to give rise to or result in: (1) any violation of applicable law or regulation; (2) any liability for the officers, directors or (except in the case of a Restricted Subsidiary that is a partnership) shareholders of such Restricted Subsidiary (or, in the case of a Restricted Subsidiary that is a partnership, directors or shareholders of the partners of such partnership); (3) any cost, expense, liability or obligation (including with respect to any Taxes) other than reasonable out-of-pocket expenses and other than reasonable expenses incurred in connection with any governmental or regulatory filings required as a result of, or any measures pursuant to clause (1) of this paragraph undertaken in connection with, such Guarantee, which in any case under any of clauses (1), (2) and (3) of this paragraph cannot be avoided through measures reasonably available to Altice International or such Restricted Subsidiary; or (4) such Restricted Subsidiary is prohibited from Incurring such Guarantee by the terms of any Indebtedness of such Restricted Subsidiary that is not prepayable without a prepayment

premium (in each case, other than Indebtedness Incurred to provide all or any portion of the funds utilized to consummate the transaction or series of related transactions pursuant to which such Person became a Restricted Subsidiary); provided that this clause (4) applies only for so long as such prepayment premium applies to such Indebtedness.

Suspension of Covenants on Achievement of Investment Grade Status

If on any date following the Issue Date, the Notes have achieved Investment Grade Status and no Default or Event of Default has occurred and is continuing (a "Suspension Event"), then, the Issuer shall notify the Trustee of these events and beginning on that day and continuing until such time, if any, at which the Notes cease to have Investment Grade Status (the "Reversion Date"), the provisions of the Indenture summarized under the following captions will not apply to the Notes: "*—Limitation on Indebtedness*", "*—Limitation on Restricted Payments*", "*—Limitation on Restrictions on Distributions from Restricted Subsidiaries*", "*—Limitation on Sales of Assets and Subsidiary Stock*", "*—Limitation on Affiliate Transactions*" and "*—Impairment of Security Interests*", the provisions of clause (3) of the first paragraph of the covenant described under "*—Merger and Consolidation—Altice International*" and, in each case, any related default provision of the Indenture will cease to be effective and will not be applicable to the Issuer, Altice International and the Restricted Subsidiaries. Such covenants and any related default provisions will again apply according to their terms from the first day on which a Suspension Event ceases to be in effect. Such covenants will not, however, be of any effect with regard to actions of the Issuer properly taken during the continuance of the Suspension Event, and the "*—Limitation on Restricted Payments*" covenant will be interpreted as if it has been in effect since the date of the Indenture except that no Default will be deemed to have occurred solely by reason of a Restricted Payment made while that covenant was suspended. On the Reversion Date, all Indebtedness Incurred during the continuance of the Suspension Event will be classified, at the Issuer's option, as having been Incurred pursuant to the first paragraph of the covenant described under "*—Limitation on Indebtedness*" or one of the clauses set forth in the second paragraph of such covenant (to the extent such Indebtedness would be permitted to be Incurred thereunder as of the Reversion Date and after giving effect to Indebtedness Incurred prior to the Suspension Event and outstanding on the Reversion Date). To the extent such Indebtedness would not be so permitted to be Incurred under the first two paragraphs of the covenant described under "*—Limitation on Indebtedness*", such Indebtedness will be deemed to have been outstanding on the Issue Date, so that it is classified as permitted under clause (4)(b) of the second paragraph of the covenant described under "*—Limitation on Indebtedness*".

Impairment of Security Interests

The Issuer shall not, Altice International shall not and shall not permit any Restricted Subsidiary to, take or omit to take any action that would have the result of materially impairing the security interest with respect to the Notes Collateral (it being understood that the Incurrence of Permitted Collateral Liens, subject to the proviso in the second sentence of the next succeeding paragraph, shall under no circumstances be deemed to materially impair the security interest with respect to the Notes Collateral) for the benefit of the Trustee and the Holders, and the Issuer shall not, Altice International shall not and shall not permit any Restricted Subsidiary to, grant to any Person other than the Security Agent (or its delegate), for the benefit of the Trustee and the Holders and the other beneficiaries described in the Security Documents, the Intercreditor Agreement or any Additional Intercreditor Agreement, any Lien over any of the Notes Collateral; *provided*, that, subject to the proviso in the second sentence of the next succeeding paragraph, (x) the Issuer, Altice International and the Restricted Subsidiaries may Incur Permitted Collateral Liens, (y) the Notes Collateral may be discharged, amended, extended, renewed, restated, supplemented, released, modified or replaced in accordance with the Indenture, the Intercreditor Agreement, any Additional Intercreditor Agreement or the applicable Security Documents and (z) and Altice International and its Restricted Subsidiaries may consummate any other transaction permitted under "*—Merger and Consolidation*".

Notwithstanding the above, nothing in this covenant shall restrict the discharge and release of any Lien over the Notes Collateral in accordance with the Indenture, the Intercreditor Agreement or any Additional Intercreditor Agreement. Subject to the foregoing, the Security Documents may be amended, extended, renewed, restated, supplemented or otherwise modified or released (followed by an immediate retaking of a Lien of at least equivalent ranking over the same assets) to (i) cure any ambiguity, omission, defect or inconsistency therein; (ii) provide for Permitted Collateral Liens; (iii) make any change reasonably necessary or desirable in the good faith determination of the Issuer in order to implement transactions permitted under "*—Merger and Consolidation*;" (iv) add to the Notes Collateral; (v) provide for the release of any Lien on any properties or assets constituting Notes Collateral from the Lien of the Security Documents; *provided* that such release is followed by the substantially concurrent re-taking of a Lien of at least equivalent priority over the same properties and assets securing the Notes or any Note Guarantee; or (vi) make any other change thereto that does not adversely affect the Holders in any material respect; provided, however, that, contemporaneously with any such action in clauses (ii), (iii), (iv), (v), and (vi) the Issuer delivers to the Trustee, either (1) a solvency opinion, in form and substance reasonably satisfactory to the Trustee, from an independent financial advisor or appraiser or investment bank of international standing which confirms the solvency of Altice International and its Subsidiaries, taken as a whole, after giving effect to any transactions related to such amendment, extension, renewal, restatement, supplement, modification or

replacement, (2) a certificate from the chief financial officer or the Board of Directors of the relevant Person which confirms the solvency of the Person granting the Lien after giving effect to any transactions related to such amendment, extension, renewal, restatement, supplement, modification or replacement, or (3) an opinion of counsel (subject to any qualifications customary for this type of opinion of counsel), in form and substance reasonably satisfactory to the Trustee, confirming that, after giving effect to any transactions related to such amendment, extension, renewal, restatement, supplement, modification or replacement, the Lien or Liens created under the Security Documents so amended, extended, renewed, restated, supplemented, modified or replaced are valid Liens not otherwise subject to any limitation, imperfection or new hardening period, in equity or at law, that such Lien or Liens were not otherwise subject to immediately prior to such amendment, extension, renewal, restatement, supplement, modification or replacement.

In the event that the Issuer, Altice International and the Restricted Subsidiaries comply with the requirements of this covenant, the Trustee and the Security Agent shall (subject to customary protections and indemnifications) consent to such amendments without the need for instructions from the Holders.

Payments for Consents

Altice International will not, and will not permit any of its Restricted Subsidiaries to, directly or indirectly, pay or cause to be paid any consideration to or for the benefit of any Holder for or as an inducement to any consent, waiver or amendment of any of the terms of the provisions of the Indenture or the Notes unless such consideration is offered to be paid and is paid to all holders of Notes that consent, waive or agree to amend in the time frame set forth in the solicitation documents relating to such consent, waiver or agreement. Notwithstanding the foregoing, Altice International and the Restricted Subsidiaries shall be permitted, in any offer or payment of consideration for, or as an inducement to, any consent, waiver or amendment of any of the terms or provisions of the Indenture, to exclude holders of Notes in any jurisdiction where (i) the solicitation of such consent, waiver or amendment, including in connection with an exchange offer or an offer to purchase for cash, or (ii) the payment of the consideration therefor would require Altice International or any Restricted Subsidiary to file a registration statement, prospectus or similar document under any applicable securities laws (including, but not limited to, the United States federal securities laws and the laws of the European Union or its member states or the State of Israel), which the Issuer in its sole discretion determine (acting in good faith) (A) would be materially burdensome (it being understood that it would not be materially burdensome to file the consent document(s) used in other jurisdictions, any substantially similar documents or any summary thereof with the securities or financial services authorities in such jurisdiction) or (B) such solicitation would otherwise not be permitted under applicable law in such jurisdiction.

Additional Intercreditor Agreements

The Indenture provides that, at the request of the Issuer, in connection with the Incurrence by Altice International or a Restricted Subsidiary of any Indebtedness that is permitted to share the Notes Collateral pursuant to the definition of Permitted Collateral Liens, Altice International or Restricted Subsidiary, the Trustee and the Security Agent shall enter into with the holders of such Indebtedness (or their duly authorized Representatives) an intercreditor agreement (an “*Additional Intercreditor Agreement*”) or a restatement, amendment or other modification of the existing Intercreditor Agreement on substantially the same terms as the Intercreditor Agreement (or terms not materially less favorable to the Holders), including containing substantially the same terms with respect to release of Note Guarantees and priority and release of the Liens over the Notes Collateral (or terms not materially less favorable to the Holders); *provided* that only one payment blockage notice (a “*Stop Notice*”) can be given by Designated Senior Indebtedness in any 360-day period or in respect of the same event or circumstances regardless of the number of Credit Facilities or other instruments constituting “*Designated Senior Indebtedness*” of a Guarantor or the number of intercreditor agreements; *provided further* that except in the event of a payment default in respect of Senior Indebtedness is outstanding, in no event may the total number of days for which a Stop Notice is in effect exceed 179 days in respect of any Stop Notice in the aggregate during any consecutive 365-day period; *provided further however provided* that such Additional Intercreditor Agreement will not impose any personal obligations on the Trustee or Security Agent or, in the opinion of the Trustee or Security Agent, as applicable, adversely affect the rights, duties, liabilities or immunities of the Trustee or Security Agent under the Indenture or the Intercreditor Agreement; *provided further* that only Designated Senior Indebtedness shall be entitled to instruct the Security Agent to enforce Collateral (other than the Issuer Share Pledge) or initiate a payment blockage. For the avoidance of doubt, subject to the foregoing and the succeeding paragraph, any such Additional Intercreditor Agreement may provide for senior, *pari passu* or subordinated security interests in respect of any such Indebtedness (to the extent such Indebtedness is permitted to share the Notes Collateral pursuant to the definition of Permitted Collateral Lien).

The Indenture provides that, at the direction of the Issuer and without the consent of Holders, the Trustee and the Security Agent shall from time to time enter into one or more amendments to any Intercreditor Agreement to: (1) cure any ambiguity, omission, defect or inconsistency of any such agreement, (2) increase the amount or types of Indebtedness covered by any such agreement that may be Incurred by the Issuer or a Guarantor that is subject to any such agreement (including with respect to any Intercreditor Agreement or Additional Intercreditor Agreement, the addition of

provisions relating to new Indebtedness ranking junior in right of payment to the Notes), (3) add Restricted Subsidiaries to the Intercreditor Agreement or an Additional Intercreditor Agreement, (4) further secure the Notes (including Additional Notes), (5) make provision for equal and ratable pledges of the Notes Collateral to secure Additional Notes, (6) implement any Permitted Collateral Liens, (7) amend the Intercreditor Agreement or any Additional Intercreditor Agreement in accordance with the terms thereof; (8) make any change reasonably necessary, in the good faith determination of the Issuer in order to implement any transaction that is subject to the covenants described under the caption “—*Merger and Consolidation*”; or (9) implement any transaction in connection with the renewal extension, refinancing, replacement or increase of Indebtedness that is not prohibited by the Indenture or make any other change to any such agreement that does not adversely affect the Holders in any material respect; *provided* that no such changes shall be permitted to the extent they affect the ranking of any Note or Note Guarantee, enforcement of Liens over the Notes Collateral, the application of proceeds from the enforcement of Notes Collateral or the release of any Note Guarantees or Lien over the Notes Collateral in a manner than would adversely affect the rights of the holders of the Notes in any material respect except as otherwise permitted by the Indenture, the Intercreditor Agreement or any Additional Intercreditor Agreement immediately prior to such change. The Issuer shall not otherwise direct the Trustee or the Security Agent to enter into any amendment to any Intercreditor Agreement without the consent of the Holders of the majority in aggregate principal amount of the Notes then outstanding, except as otherwise permitted below under “—*Amendments and Waivers*”, and the Issuer may only direct the Trustee and the Security Agent to enter into any amendment to the extent such amendment does not impose any personal obligations on the Trustee or Security Agent or, in the opinion of the Trustee or Security Agent, adversely affect their respective rights, duties, liabilities or immunities under the Indenture or the Intercreditor Agreement or any Additional Intercreditor Agreement.

The Indenture also provides that, in relation to any Intercreditor Agreement or Additional Intercreditor Agreement, at the request of the Issuer, the Trustee (and Security Agent, if applicable) shall consent on behalf of the Holders to the payment, repayment, purchase, repurchase, defeasance, acquisition, retirement or redemption of any obligations subordinated to the Notes thereby; *provided, however*, that such transaction would comply with the covenant described under “—*Limitation on Restricted Payments*”.

The Indenture also provides that each Holder, by accepting a Note, shall be deemed to have agreed to and accepted the terms and conditions of the Intercreditor Agreement or any Additional Intercreditor Agreement (whether then entered into or entered into in the future pursuant to the provisions described herein), and to have directed the Trustee and the Security Agent to enter into any such Additional Intercreditor Agreement.

Completion Date and Post-Completion Date Guarantees and Security

Subject to the Agreed Security Principles:

On the Completion Date:

- (1) Altice International will cause each Completion Date Guarantor to execute a supplemental indenture Guaranteeing the Notes on a senior subordinated basis; and
- (2) the Issuer will make the Additional Proceeds Loan with the proceeds of the offering of the Notes to the Senior Secured Notes Issuer and the Issuer will grant second-ranking Lien over such Additional Proceeds Loan for the benefit of the holders of the Notes; and
- (3) each of the Issuer and Altice International will and/or will cause each of the relevant Restricted Subsidiaries or security grantor to grant first-ranking or second-ranking Liens, as applicable, over the property and asset described above under “*Note Security*”.

Within 90 days following the Completion Date (if it occurs), Altice International will cause each Post-Completion Date Guarantor to execute (i) a supplemental indenture Guaranteeing the Notes on a senior subordinated basis and (ii) a supplemental indenture to each Existing Senior Notes Indenture Guaranteeing the Existing Senior Notes on a senior subordinated basis.

Completion of Transactions

The Issuer and Altice International shall cause the Acquisition to be consummated promptly upon the release of the Escrowed Property following delivery by the Issuer to the Escrow Agent of a release officer’s certificate under the Notes Escrow Agreement.

Events of Default

Each of the following is an “Event of Default” under the Indenture:

- (1) default in any payment of interest or Additional Amounts, if any, on any Note issued under the Indenture when due and payable, continued for 30 days;
- (2) default in the payment of the principal amount of or premium, if any, on any Note issued under the Indenture when due at its Stated Maturity, upon optional redemption, upon required repurchase, upon declaration or otherwise;
- (3) failure by Altice International or any Restricted Subsidiary to comply for 30 days after notice by the Trustee or the Holders of at least 25% in principal amount of the outstanding Notes with any of its obligations under the covenants described under “Change of Control” above or under the covenants described under “—*Certain Covenants*” above (in each case, other than (i) a failure to purchase Notes, which will constitute an Event of Default under clause (2) above; (ii) a failure to comply with the covenant described under “—*Certain Covenants—Completion Date and Post-Completion Date Guarantees and Security*”, which shall be governed by clause (10) below, (iii) a failure to comply with the Notes Escrow Agreement and (iv) a failure to comply with the covenant described under “—*Certain Covenants—Completion of the Transactions*”, which shall be governed by clause (12) below);
- (4) failure by Altice International, any Restricted Subsidiary or any other grantor of a Lien over the Notes Collateral to comply for 60 days after notice by the Trustee or the Holders of at least 25% in principal amount of the outstanding Notes with its other agreements contained in the Indenture, the Intercreditor Agreement, any Additional Intercreditor Agreement or the Security Documents;
- (5) default under any mortgage, indenture or instrument under which there may be issued or by which there may be secured or evidenced any Indebtedness for money borrowed by Altice International or any Restricted Subsidiary (or the payment of which is Guaranteed by Altice International or any Restricted Subsidiary) other than Indebtedness owed to Altice International or a Restricted Subsidiary whether such Indebtedness or Guarantee now exists, or is created after the Issue Date, which default:
 - (a) is caused by the failure to pay principal of such Indebtedness at the Stated Maturity thereof prior to the expiration of the grace period provided in such Indebtedness on the date of such default (“payment default”); or
 - (b) results in the acceleration of such Indebtedness prior to its maturity (the “cross-acceleration provision”),

and, in each case, the principal amount of any such Indebtedness, together with the principal amount of any other such Indebtedness under which there has been a payment default or the maturity of which has been so accelerated, aggregates €25 million or more;

- (6) certain events of bankruptcy, insolvency or court protection of the Issuer, Altice International or a Significant Subsidiary or group of Restricted Subsidiaries that, taken together, would constitute a Significant Subsidiary (the “bankruptcy provisions”);
- (7) failure by the Issuer, Altice International or a Significant Subsidiary or group of Restricted Subsidiaries that, taken together, would constitute a Significant Subsidiary to pay final judgments aggregating in excess of €25 million exclusive of any amounts that a solvent insurance company has acknowledged liability for, which judgments are not paid, discharged or stayed for a period of 60 days after the judgment becomes final (the “judgment default provision”);
- (8) any security interest under the Security Documents shall, at any time, cease to be in full force and effect (other than in accordance with the terms of the relevant Security Document, the Intercreditor Agreement, any Additional Intercreditor Agreement and the Indenture) with respect to Notes Collateral having a fair market value in excess of €10 million for any reason other than the satisfaction in full of all obligations under the Indenture or the release of any such security interest in accordance with the terms of the Indenture, the Intercreditor Agreement, any Additional Intercreditor Agreement or the Security Documents or any such security interest created thereunder shall be declared invalid or unenforceable and the Issuer shall assert in writing that any such security interest is invalid or unenforceable and any such Default continues for 10 days (the “security default provisions”);
- (9) any Note Guarantee by Altice International or a Subsidiary Guarantor that is a Significant Subsidiary or any group of Subsidiary Guarantors that taken together would constitute a Significant Subsidiary ceases to be in full force and effect (other than in accordance with the terms of such Note Guarantee or the Indenture) or is declared invalid or unenforceable in a judicial proceeding or any Guarantor denies or disaffirms in writing its obligations

under its Note Guarantee and any such Default continues for 10 days after the notice specified in the Indenture (the “guarantee provisions”);

- (10) failure by Altice International or any Restricted Subsidiary to comply for 30 days with any of the provisions of the covenant described under “—*Certain Covenants—Completion Date and Post-Completion Date Guarantees and Security*”;
- (11) failure by the Issuer to consummate the Special Mandatory Redemption as described under the caption “—*Escrow of Proceeds; Special Mandatory Redemption*,” and
- (12) failure by the Issuer to comply with the covenant described under “—*Certain Covenants—Completion of the Transactions*” for more than 5 Business Days following the date on which the Escrowed Property are released from the Notes Escrow Account.

However, a default under clauses (3), (4), (5), (7) or (10) of this paragraph will not constitute an Event of Default until the Trustee or the Holders of 25% in principal amount of the outstanding Notes under the Indenture notify the Issuer of the default and, with respect to clauses (3), (4), (5), (7) and (10) the Issuer does not cure such default within the time specified in clauses (3), (4), (5), (7) or (10), as applicable, of this paragraph after receipt of such notice.

If an Event of Default described in clause (6) or (11) above occurs and is continuing, the principal of, premium, if any, and accrued and unpaid interest on all the Notes, and any additional amounts, if any, will become and be immediately due and payable without any declaration or other act on the part of the Trustee or any Holders. If any other Event of Default occurs and is continuing, the Trustee or the Holders of at least 25% in aggregate principal amount of the then outstanding Notes may and, if directed by holders of at least 25% in aggregate principal amount of the then outstanding Notes, the Trustee shall, declare all the Notes to be due and payable immediately. In the event of a declaration of acceleration of the Notes because an Event of Default described in clause (5) under “Events of Default” has occurred and is continuing, the declaration of acceleration of the Notes shall be automatically annulled if the event of default or payment default triggering such Event of Default pursuant to clause (5) shall be remedied or cured, or waived by the holders of the relevant Indebtedness, or the relevant Indebtedness that gave rise to such Event of Default shall have been discharged in full, within 30 days after the declaration of acceleration with respect thereto and if (i) the annulment of the acceleration of the Notes would not conflict with any judgment or decree of a court of competent jurisdiction and (ii) all existing Events of Default, except nonpayment of principal, premium or interest, including Additional Amounts, if any, on the Notes that became due solely because of the acceleration of the Notes, have been cured or waived.

Holders of the Notes may not enforce the Indenture or the Notes except as provided in the Indenture and may not enforce the Security Documents except as provided in such Security Documents and the Intercreditor Agreement or any Additional Intercreditor Agreement.

The Holders of a majority in principal amount of the outstanding Notes under the Indenture may waive all past or existing Defaults or Events of Default (except with respect to nonpayment of principal, premium, interest or Additional Amounts, if any) and rescind any such acceleration with respect to such Notes and its consequences if rescission would not conflict with any judgment or decree of a court of competent jurisdiction.

Subject to the provisions of the Indenture relating to the duties of the Trustee, if an Event of Default occurs and is continuing, the Trustee will be under no obligation to exercise any of the rights or powers under the Indenture at the request or direction of any of the Holders unless such Holders have offered to the Trustee, and the Trustee has received, indemnity and/or security satisfactory to the Trustee against any loss, liability or expense. Except to enforce the right to receive payment of principal or interest when due, no Holder may pursue any remedy with respect to the Indenture or the Notes unless:

- (1) such Holder has previously given the Trustee notice that an Event of Default is continuing;
- (2) Holders of at least 25% in aggregate principal amount of the outstanding Notes have requested the Trustee to pursue the remedy;
- (3) such Holders have offered the Trustee, and the Trustee has received, security and/or indemnity satisfactory to it against any loss, liability or expense;
- (4) the Trustee has not complied with such request within 60 days after the receipt of the request and the offer of security and/or indemnity; and
- (5) the Holders of a majority in aggregate principal amount of the outstanding Notes have not given the Trustee a direction that, in the opinion of the Trustee, is inconsistent with such request within such 60-day period.

Subject to certain restrictions, the Holders of a majority in principal amount of the outstanding Notes are given the right to direct the time, method and place of conducting any proceeding for any remedy available to the Trustee (on behalf of the Holders) or of exercising any trust or power conferred on the Trustee (on behalf of the Holders).

The Indenture provides that, in the event an Event of Default has occurred and is continuing of which a responsible officer of the Trustee is aware, the Trustee will be required in the exercise of its powers to use the degree of care that a prudent person would use in the conduct of its own affairs. The Trustee, however, may refuse to follow any direction that conflicts with law or the Indenture or that the Trustee determines is unduly prejudicial to the rights of any other Holder or that would involve the Trustee in personal liability. Prior to taking any action under the Indenture, the Trustee will be entitled to indemnification and/or security satisfactory to it in its sole discretion against all losses and expenses caused by taking or not taking such action. The Indenture provides that if a Default occurs and is continuing and a responsible officer of the Trustee is informed of such occurrence by the Issuer, the Trustee must give notice of the Default to the Holders within 60 days after being notified by the Issuer. Except in the case of a Default in the payment of principal of, or premium, if any, or interest on any Note, the Trustee may withhold notice if and so long as a committee of trust officers of the Trustee in good faith determines that withholding notice is in the interests of the Holders. The Issuer is required to deliver to the Trustee, within 120 days after the end of each fiscal year, an Officer's Certificate indicating whether the signers thereof know of any Default that occurred during the previous year. The Issuer is required to deliver to the Trustee, within 30 days after the occurrence thereof, written notice of any events of which it is aware which would constitute certain Defaults, their status and what action the Issuer is taking or proposes to take in respect thereof.

The Notes provide for the Trustee to take action on behalf of the Holders in certain circumstances, but only if the Trustee is indemnified and/or secured to its satisfaction. It may not be possible for the Trustee to take certain actions in relation to the Notes and, accordingly, in such circumstances the Trustee will be unable to take action, notwithstanding the provision of an indemnity to it, and it will be for Holders to take action directly.

Amendments and Waivers

Subject to certain exceptions, the Notes Documents may be amended, supplemented or otherwise modified with the consent of the Holders of a majority in principal amount of the Notes then outstanding (including consents obtained in connection with a purchase of, or tender offer or exchange offer for, Notes) and, subject to certain exceptions, any default or compliance with any provisions thereof may be waived with the consent of the Holders of a majority in principal amount of the Notes then outstanding (including consents obtained in connection with a purchase of, or tender offer or exchange offer for, Notes). However, without the consent of Holders holding not less than 90% of the then outstanding principal amount of Notes affected (including consents obtained in connection with a purchase of, or tender offer or exchange offer for, Notes), an amendment or waiver may not, with respect to any Notes held by a non-consenting Holder:

- (1) reduce the principal amount of Notes whose Holders must consent to an amendment, waiver, supplement or modification;
- (2) reduce the stated rate of or extend the stated time for payment of interest on any Note (other than, for the avoidance of doubt, any payment pursuant to a Change of Control Offer or pursuant to the provisions of the covenant described under the caption "*—Limitation on Sales of Assets and Subsidiary Stock*");
- (3) reduce the principal of, or extend the Stated Maturity of, any Note;
- (4) reduce the premium payable upon the redemption of any Note or change the time at which any Note may be redeemed, in each case as described above under "*—Optional Redemption*" (other than, for the avoidance of doubt, any payment pursuant to a Change of Control Offer or pursuant to the provisions of the covenant described under the caption "*—Limitation on Sales of Assets and Subsidiary Stock*");
- (5) make any Note payable in money other than that stated in the Note (except to the extent the currency stated in the Notes has been succeeded or replaced pursuant to applicable law);
- (6) impair the right of any Holder to receive payment of principal of and interest or Additional Amounts, if any, on such Holder's Notes on or after the due dates therefor or to institute suit for the enforcement of any such payment on or with respect to such Holder's Notes (it being understood that this clause (6) will not apply to provisions under the caption "*Change of Control*" and "*Limitation on Sales of Assets and Subsidiary Stock*" except to the extent payments thereunder are at such time due and payable);
- (7) make any change in the provision of the Indenture described under "*Withholding Taxes*" that adversely affects the right of any Holder of such Notes in any material respect or amends the terms of such Notes in a way that would result in a loss of an exemption from any of the Taxes described thereunder or an exemption from any

obligation to withhold or deduct Taxes so described thereunder unless the payor agrees to pay Additional Amounts, if any, in respect thereof;

- (8) waive a Default or Event of Default with respect to the nonpayment of principal, premium or interest or Additional Amounts, if any, on the Notes (except pursuant to a rescission of acceleration of the Notes by the Holders of at least a majority in aggregate principal amount of such Notes and a waiver of the payment default that resulted from such acceleration); or
- (9) make any change in the amendment or waiver provisions which require the Holders' consent described in this sentence.

In addition, (A) without the consent of at least 75% in aggregate principal amount of Notes then outstanding, no amendment or supplement may: (1) release any Guarantor from any of its obligations under its Note Guarantee or the Indenture, except in accordance with the terms of the Indenture and the Intercreditor Agreement; or (2) release any of the security interests granted for the benefit of the Holders in the Notes Collateral, (to the extent any Notes Collateral so released in any transactions or series of transactions has a fair market value in excess of €25 million) other than in accordance with the terms of, as applicable, the Security Documents, the Intercreditor Agreement, any applicable Additional Intercreditor Agreement, and the Indenture, as applicable. Notwithstanding the foregoing, without the consent of any Holder, the Issuer, the Trustee, the Security Agent and the other parties thereto, as applicable, may amend or supplement any Notes Documents to:

- (1) cure any ambiguity, omission, defect, error or inconsistency;
- (2) provide for the assumption by a successor Person of the obligations of the Issuer or any Guarantor under any Notes Document;
- (3) add to the covenants or provide for a Guarantee for the benefit of the Holders or surrender any right or power conferred upon Altice International or any Restricted Subsidiary;
- (4) make any change that would provide additional rights or benefits to the Trustee or the Holders or does not adversely affect the rights or benefits to the Trustee or any of the Holders in any material respect under the Notes Documents;
- (5) make such provisions as necessary (as determined in good faith by the Issuer) for the issuance of Additional Notes Incurred in accordance with the terms of the Indenture;
- (6) provide for Altice International or a Restricted Subsidiary to provide a Note Guarantee in accordance with the Indenture, to add Guarantees with respect to the Notes, to add security to or for the benefit of the Notes, or to effectuate or confirm and evidence the release, termination, discharge or retaking of any Note Guarantee or Lien (including the Notes Collateral and the Security Documents) or any amendment in respect thereof with respect to or securing the Notes when such release, termination, discharge or retaking or amendment is provided for under the Indenture, the Security Documents, the Intercreditor Agreement or any Additional Intercreditor Agreement;
- (7) conform the text of the Indenture, the Note Guarantees, the Security Documents or the Notes to any provision of this Description of Senior Notes to the extent that such provision in this Description of Senior Notes was intended to be a verbatim recitation of a provision of the Indenture, a Note Guarantee, the Security Documents or the Notes;
- (8) evidence and provide for the acceptance and appointment under the Indenture or the Intercreditor Agreement or any Additional Intercreditor Agreement of a successor Trustee or Security Agent pursuant to the requirements thereof or to provide for the accession by the Trustee or Security Agent to any Notes Document;
- (9) as provided in "*Certain Covenants—Additional Intercreditor Agreements*";
- (10) provide for the assumption of a successor Person of the obligations of HOT or any HOT Proceeds Note Guarantor under any HOT Proceeds Note Document;
- (11) add to the covenants or provide for a HOT Proceeds Note Guarantee for the benefit of the Issuer or surrender any right or power conferred upon HOT, a HOT Proceeds Note Guarantor or any Restricted Subsidiary of HOT;

- (12) make any change that would provide additional rights or benefits to the Issuer or does not adversely affect the rights or benefits to the Issuer in any material respect, in each case, under the HOT Proceeds Note Documents or any other Finco Proceeds Loan;
- (13) provide for to add Guarantees with respect to the HOT Proceeds Note, to add security to or for the benefit of the HOT Proceeds Note, or to effectuate or confirm and evidence the release, termination, discharge or retaking of any HOT Proceeds Note Guarantee or Lien (including the HOT Proceeds Note Collateral and the HOT Security Documents) or any amendment in respect thereof with respect to or securing the HOT Proceeds Note when such release, termination, discharge or retaking or amendment is provided for under the Indenture, the HOT Security Documents or any intercreditor agreement relating to the HOT Proceeds Note; or
- (14) after a HOT Direct Obligation Event, amend, extend, renew, restate, supplement or otherwise modify or release the HOT Proceeds Note and the HOT Security Documents, as the case may be, to give effect to a repayment or reduction in the aggregate principal amount of the HOT Proceeds Note.

In formulating its decision on such matters, the Trustee shall be entitled to require and rely absolutely on such evidence as it deems necessary, including Officer's Certificates and Opinions of Counsel.

The consent of the Holders is not necessary under the Indenture to approve the particular form of any proposed amendment. It is sufficient if such consent approves the substance of the proposed amendment. A consent to any amendment or waiver under the Indenture by any Holder of Notes given in connection with a tender of such Holder's Notes will not be rendered invalid by such tender.

For the avoidance of doubt, the provisions of articles 86 to 94-8 of the Luxembourg act dated 10 August 1915 on commercial companies, as amended, shall not apply in respect of the Notes.

For so long as the Notes are listed on the Euro MTF Market of the Luxembourg Stock Exchange and the rules of such exchange so require, the Issuer will publish notice of any amendment, supplement and waiver in Luxembourg in a daily newspaper with general circulation in Luxembourg (which is expected to be the *Luxemburger Wort*). Such notice of any amendment, supplement and waiver may also be published on the website of the Luxembourg Stock Exchange (www.bourse.lu), to the extent and in the manner permitted by the rules of the Luxembourg Stock Exchange.

Acts by Holders

In determining whether the Holders of the required principal amount of the Notes have concurred in any direction, waiver or consent, the Notes owned by Altice International or by any Person directly or indirectly controlling, or controlled by, or under direct or indirect common control with Altice International will be disregarded and deemed not to be outstanding.

Defeasance

The Issuer at any time may terminate all obligations of the Issuer under the Notes and the Indenture ("legal defeasance") and cure all then existing Defaults and Events of Default, except for certain obligations, including those respecting the right to receive payment, defeasance trust, the rights, powers, trusts, duties, immunities and indemnities of the Trustee and the obligations of the Issuer in connection therewith and obligations concerning issuing temporary Notes, registration of Notes, mutilated, destroyed, lost or stolen Notes and the maintenance of an office or agency for payment and money for security payments held in trust. Subject to the foregoing, if the Issuer exercises its legal defeasance option, the Security Documents and the rights of the Trustee and the Holders under the Intercreditor Agreement or any Additional Intercreditor Agreement in effect at such time will terminate (other than with respect to the defeasance trust).

The Issuer at any time may terminate its obligations under certain covenants described under "*Certain Covenants*" and "*Change of Control*" and the default provisions relating to such covenants described under "*Events of Default*" above, the operation of the cross-default upon a payment default, the cross-acceleration provisions, the bankruptcy provisions with respect to the Issuer, Altice International and Significant Subsidiaries, the judgment default provision, the guarantee provision and the security default provision described under "*Events of Default*" above ("covenant defeasance").

The Issuer at its option at any time may exercise its legal defeasance option notwithstanding its prior exercise of its covenant defeasance option. If the Issuer exercises its legal defeasance option, payment of the Notes may not be accelerated because of an Event of Default with respect to such Notes. If the Issuer exercises its covenant defeasance option with respect to the Notes, payment of the Notes may not be accelerated because of an Event of Default specified in clause (3) (other than with respect to the first paragraph and clauses (1) and (2) of the second paragraph of the covenant described under "*Certain Covenants—Merger and Consolidation*"), (4), (5), (6) (with respect only to Altice International and Significant Subsidiaries), (7), (8) or (9) under "*Events of Default*" above.

In order to exercise either defeasance option, the Issuer must irrevocably deposit in trust (the “defeasance trust”) with the Trustee (or an entity designated or appointed as agent by it for this purpose) cash in U.S. dollars or U.S. dollar-denominated U.S. Government Obligations or a combination thereof for the payment of principal, premium, if any, and interest on the Notes to redemption or maturity, as the case may be, and must comply with certain other conditions, including delivery to the Trustee of:

- (1) an Opinion of Counsel (subject to customary exceptions and exclusions) from United States counsel to the effect that Holders of the Notes will not recognize income, gain or loss for U.S. federal income tax purposes as a result of such deposit and defeasance and will be subject to U.S. federal income tax on the same amount and in the same manner and at the same times as would have been the case if such deposit and defeasance had not occurred (and in the case of legal defeasance only, such Opinion of Counsel from United States counsel must be based on a ruling of the U.S. Internal Revenue Service or other change in applicable U.S. federal income tax law);
- (2) an Officer’s Certificate stating that the deposit was not made by the Issuer with the intent of defeating, hindering, delaying, defrauding or preferring any creditors of the Issuer;
- (3) an Officer’s Certificate stating that all conditions precedent provided for or relating to legal defeasance or covenant defeasance, as the case may be, have been complied with; and
- (4) an Opinion of Counsel to the effect that the trust resulting from the deposit does not constitute, or is qualified as, a regulated investment company under the U.S. Investment Company Act of 1940, as amended.

Satisfaction and Discharge

The Indenture, and the rights of the Trustee and the Holders under the Intercreditor Agreement, any Additional Intercreditor Agreement and the Security Documents will be discharged and cease to be of further effect (except as to surviving rights of conversion or transfer or exchange of the Notes, as expressly provided for in the Indenture) as to all outstanding Notes when (1) either (a) all the Notes previously authenticated and delivered (other than certain lost, stolen or destroyed Notes, and certain Notes for which provision for payment was previously made and thereafter the funds have been released to the Issuer) have been delivered to the relevant Paying Agent for cancellation; or (b) all Notes not previously delivered to the relevant Paying Agent for cancellation (i) have become due and payable, (ii) will become due and payable at their Stated Maturity within one year or (iii) are to be called for redemption within one year under arrangements reasonably satisfactory to the Trustee for the giving of notice of redemption by the Trustee in the name, and at the expense, of the Issuer; (2) the Issuer has deposited or caused to be deposited with the Trustee (or an entity designated or appointed as agent by it for this purpose), cash in U.S. dollars or U.S. dollar-denominated U.S. Government Obligations or a combination thereof, in an amount sufficient to pay and discharge the entire Indebtedness on the Notes not previously delivered to the Trustee for cancellation, for principal, premium, if any, and interest to the date of deposit (in the case of Notes that have become due and payable), or to the Stated Maturity or redemption date, as the case may be; (3) the Issuer has paid or caused to be paid all other sums payable under the Indenture; and (4) the Issuer has delivered to the Trustee an Officer’s Certificate to the effect that all conditions precedent under the “Satisfaction and Discharge” section of the Indenture relating to the satisfaction and discharge of the Indenture have been complied with.

No Personal Liability of Directors, Officers, Employees and Shareholders

No director, officer, employee, incorporator or shareholder of the Issuer, Altice International or any of their respective Subsidiaries or Affiliates, as such, shall have any liability for any obligations of the Issuer under the Notes Documents or for any claim based on, in respect of, or by reason of, such obligations or their creation. Each Holder by accepting a Note waives and releases all such liability. The waiver and release are part of the consideration for issuance of the Notes. Such waiver may not be effective to waive liabilities under the U.S. federal securities laws, and it is the view of the SEC that such a waiver is against public policy.

Listing and general information

Application has been made to list the Notes on the Official List of the Luxembourg Stock Exchange and to admit the Notes to trading on the Euro MTF Market. There can be no assurance that the application to list the Notes on the Euro MTF Market of the Luxembourg Stock Exchange and to admit the Notes to trading on the Euro MTF Market will be approved, and settlement of the Notes is not conditioned on obtaining this listing. So long as the Notes are listed on the Official List of the Luxembourg Stock Exchange and admitted to trading on its Euro MTF Market and the rules and regulations of the Luxembourg Stock Exchange shall so require, copies, current and future, of all of Altice International’s annual audited consolidated financial statements, Altice International’s unaudited consolidated interim quarterly financial statements and this Offering Memorandum may be obtained, free of charge, during normal business hours at the registered office of the Issuer.

Available Information

Anyone who receives this Offering Memorandum, any Holder of the Notes or holder of a beneficial interest in the Notes, following the Issue Date, may obtain a copy of the Indenture, the form of Notes, the Security Documents, the Notes Escrow Agreement and the Intercreditor Agreement without charge by writing to the Issuer, 3 Boulevard Royal, L-2449 Luxembourg, Attention: Chief Financial Officer.

Concerning the Trustee and Certain Agents

Deutsche Bank AG, London Branch has been appointed as Trustee under the Indenture. The Indenture provides that, except during the continuance of an Event of Default, the Trustee will perform only such duties as are set forth specifically in the Indenture. The holders of a majority in aggregate principal amount of the then outstanding Notes will have the right to direct the time, method and place of conducting any proceeding for exercising any remedy available to the Trustee, subject to certain exceptions. During the existence of an Event of Default of which the Trustee has been notified in accordance with the provisions of the Indenture, the Trustee will exercise such of the rights and powers vested in it under the Indenture and use the same degree of care that a prudent Person would use in conducting its own affairs. The permissive rights of the Trustee to take or refrain from taking any action enumerated in the Indenture will not be construed as an obligation or duty.

The Issuer shall deliver written notice to the Trustee with thirty (30) days of becoming aware of the occurrence of a Default or Event of Default. The Indenture imposes certain limitations on the rights of the Trustee, should it become a creditor of the Issuer, to obtain payment of claims in certain cases, or to realize on certain property received in respect of any such claim as security or otherwise. The Trustee, the Paying Agents and the Registrars will be permitted to engage in other transactions with the Issuer and its Affiliates and Subsidiaries.

Any removal or resignation of the Trustee shall not become effective until the acceptance of appointment by the successor Trustee.

The Indenture contains provisions for the indemnification and/or security of the Trustee by the Issuer and the Guarantors for any loss, liability, taxes or expenses incurred without gross negligence, willful misconduct or bad faith on its part, arising out of or in connection with the acceptance or administration of the Indenture.

Notices

All notices to Holders of the Notes will be validly given if mailed to them at their respective addresses in the register of the Holders of such Notes, if any, maintained by the Registrar. In addition, for so long as any of the Notes are listed on the Euro MTF Market of the Luxembourg Stock Exchange and the rules of the Luxembourg Stock Exchange so require, notices with respect to the Notes will be published in a newspaper having a general circulation in Luxembourg (which is expected to be the *Luxemburger Wort*) or, to the extent and in the manner permitted by such rules, posted on the official website of the Luxembourg Stock Exchange (www.bourse.lu).

Each such notice shall be deemed to have been given on the date of such publication or, if published more than once on different dates, on the first date on which publication is made; *provided* that, if notices are mailed, such notice shall be deemed to have been given on the later of such publication and the seventh day after being so mailed. Any notice or communication mailed to a Holder shall be mailed to such Person by first-class mail or other equivalent means and shall be sufficiently given to such Holder if so mailed within the time prescribed. Failure to mail a notice or communication to a Holder or any defect in it shall not affect its sufficiency with respect to other Holders. If a notice or communication is mailed in the manner provided above, it is duly given, whether or not the addressee receives it.

For Notes which are represented by global certificates held on behalf of DTC, notices may be given by delivery of the relevant notices to DTC, for communication to entitled account holders in substitution for the aforesaid mailing.

Prescription

Claims against the Issuer or any Guarantor for the payment of principal, or premium, if any, on the Notes will be prescribed ten years after the applicable due date for payment thereof. Claims against the Issuer or any Guarantor for the payment of interest on the Notes will be prescribed five years after the applicable due date for payment of interest.

Currency Indemnity

U.S. dollars are the sole currency of account and payment for all sums payable by the Issuer and the Guarantors under or in connection with the Notes and the Note Guarantees, as the case may be, including damages. Any amount received or

recovered in a currency other than U.S. dollars, whether as a result of, or the enforcement of, a judgment or order of a court of any jurisdiction, in the winding-up or dissolution of the Issuer, any Guarantor or otherwise by any Holder or by the Trustee, in respect of any sum expressed to be due to it from the Issuer or a Guarantor will only constitute a discharge to the Issuer or such Guarantor, as applicable, to the extent of the U.S. dollars amount, which the recipient is able to purchase with the amount so received or recovered in that other currency on the date of that receipt or recovery (or, if it is not practicable to make that purchase on that date, on the first date on which it is practicable to do so).

If that U.S. dollars amount is less than the U.S. dollars amount expressed to be due to the recipient or the Trustee under any Note, the Issuer and the Guarantors will indemnify them against any loss sustained by such recipient or the Trustee as a result. In any event, the Issuer and the Guarantors will indemnify the recipient or the Trustee on a joint or several basis against the cost of making any such purchase. For the purposes of this currency indemnity provision, it will be *prima facie* evidence of the matter stated therein for the Holder of a Note or the Trustee to certify in a manner reasonably satisfactory to the Issuer (indicating the sources of information used) the loss it Incurred in making any such purchase. These indemnities constitute a separate and independent obligation from the Issuer's and the Guarantors' other obligations, will give rise to a separate and independent cause of action, will apply irrespective of any waiver granted by any Holder of a Note or the Trustee (other than a waiver of the indemnities set out herein) and will continue in full force and effect despite any other judgment, order, claim or proof for a liquidated amount in respect of any sum due under any Note, any Note Guarantee or to the Trustee.

Enforceability of Judgments

Since substantially all the assets of the Issuer, Altice International and the other Guarantors are located outside the United States, any judgment obtained in the United States against the Issuer or any Guarantor, including judgments with respect to the payment of principal, premium, interest, Additional Amounts, if any, and any redemption price and any purchase price with respect to the Notes or the Note Guarantees, may not be collectable within the United States.

Consent to Jurisdiction and Service

In relation to any legal action or proceedings arising out of or in connection with the Indenture, the Notes and the Note Guarantees, the Issuer and each Guarantor will, in the Indenture, appoint CT Corporation System as its agent for service of process and irrevocably submit to the jurisdiction of the federal and state courts in the Borough of Manhattan in the City of New York, County and State of New York, United States.

Governing Law

The Indenture, the Notes and the Note Guarantees, and the rights and duties of the parties thereunder shall be governed by and construed in accordance with the laws of the State of New York. The application of the provisions set out in Articles 86 to 94-8 of the Luxembourg law dated August 10, 1915 on commercial companies, as amended, is excluded. The Intercreditor Agreement is, and the rights and duties of the parties thereunder are, governed by and construed in accordance with the laws of England. The Security Documents shall be governed by and construed in accordance with the laws of the State of Israel and the Grand Duchy of Luxembourg, as applicable.

Certain Definitions

Set forth below are certain defined terms used in the Indenture. Reference is made to the Indenture for a full disclosure of all defined terms used therein, as well as any other capitalized terms used herein for which no definition is provided.

“*2013 Revolving Credit Facility*” means the revolving credit facility agreement, dated July 1, 2013, as amended, restated, supplemented or otherwise modified from time to time, among the Senior Secured Notes Issuer, as borrower, the lenders from time to time party thereto, Citibank International Plc as facility agent and Citibank, N.A., London Branch, as security agent.

“*ABO*” means Altice Blue One SAS, a société par actions simplifiée, incorporated under the laws of France.

“*Acquired Indebtedness*” means Indebtedness (1) of a Person or any of its Subsidiaries existing at the time such Person becomes a Restricted Subsidiary, (2) assumed in connection with the acquisition of assets from such Person, in each case whether or not Incurred by such Person in connection with such Person becoming a Restricted Subsidiary or such acquisition, or (3) of a Person at the time such Person merges with or into or consolidates or otherwise combines with Altice International or any Restricted Subsidiary. Acquired Indebtedness shall be deemed to have been Incurred, with respect to clause (1) of the preceding sentence, on the date such Person becomes a Restricted Subsidiary and, with respect to clause (2) of the preceding sentence, on the date of consummation of such acquisition of assets and, with respect to clause (3) of the preceding sentence, on the date of the relevant merger, consolidation or other combination.

“Additional Assets” means:

- (1) any property or assets (other than Indebtedness and Capital Stock) not classified as current assets under IFRS used or to be used by Altice International or a Restricted Subsidiary or otherwise useful in a Similar Business (it being understood that capital expenditures on property or assets already used in a Similar Business or to replace any property or assets that are the subject of an Asset Disposition shall be deemed an investment in Additional Assets);
- (2) the Capital Stock of a Person that is engaged in a Similar Business and becomes a Restricted Subsidiary as a result of the acquisition of such Capital Stock by Altice International or a Restricted Subsidiary; or
- (3) Capital Stock constituting a minority interest in any Person that at such time is a Restricted Subsidiary.

“Additional Revolving Credit Facilities” means the New Super Senior Revolving Credit Facility and the New Pari Passu Revolving Credit Facility.

“Affiliate” of any specified Person means any other Person, directly or indirectly, controlling or controlled by or under direct or indirect common control with such specified Person. For the purposes of this definition, “control” when used with respect to any Person means the power to direct the management and policies of such Person, directly or indirectly, whether through the ownership of voting securities, by contract or otherwise; and the terms “controlling” and “controlled” have meanings correlative to the foregoing.

“Aggregate Portuguese Security and Guarantee Limit Amount” refers to, as applicable, (1) €95 million, representing the maximum aggregate amount of obligations (i) guaranteed and/or secured by Altice Portugal and Cabovisão, which limitation applies to all indebtedness so guaranteed and/or secured on an aggregate basis; (2) €45.8 million, representing the maximum aggregate amount of obligations guaranteed and/or secured by the ONI Group, which limitation applies to all indebtedness so secured and/or guaranteed on an aggregate basis; and (3) (i) up to €4,634.4 million for the Target and (ii) €968.4 million for PT OpCo, representing the maximum aggregate amount of obligations secured by the Target and PT OpCo, respectively, and guaranteed by the Target and PT OpCo, respectively, which limitation applies to all indebtedness so guaranteed and/or secured on an aggregate basis.

“Agreed Security Principles” means principles set forth in Schedule 16 to the Additional Revolving Credit Facilities, which shall be attached as a schedule to the Indenture.

“AI Mandatory Convertible Notes” means the mandatory convertible notes issue by Altice International for an aggregate nominal amount of up to €2,055 million and subscribed to by Altice S.A. in connection with the Transactions.

“Altice Bahamas” means Altice Bahamas S.à r.l., a private limited liability company (*société à responsabilité limitée*), incorporated under the laws of the Grand Duchy of Luxembourg.

“Altice Holdings” refers to Altice Holdings S.à r.l., a private limited liability company (*société à responsabilité limitée*), incorporated under the laws of the Grand Duchy of Luxembourg.

“Altice Portugal” means Altice Portugal, S.A. a public limited liability company (*sociedade anónima*) incorporated under the laws of Portugal.

“Altice West Europe” refers to Altice West Europe S.à r.l. a private limited liability company (*société à responsabilité limitée*) incorporated under the laws of the Grand Duchy of Luxembourg.

“Applicable Premium” means, with respect to any Note the greater of:

- (A) 1% of the principal amount of such Note; and
- (B) the excess (to the extent positive) of:
 - (i) the present value at such redemption date of (i) the redemption price of such Note at February 15, 2020 (such redemption price (expressed in percentage of principal amount) being set forth in the table above under the first paragraph of the “—Optional Redemption” section described above (excluding accrued and unpaid interest)), plus (ii) all required interest payments due on such Note to and including February 15, 2020 (excluding accrued but unpaid interest), computed upon the redemption date using a discount rate equal to the Treasury Rate at such redemption date plus 50 basis points; over

- (ii) the outstanding principal amount of such Note,

as calculated by the Issuer or on behalf of the Issuer by such Person as the Issuer shall designate. For the avoidance of doubt, calculation of the Applicable Premium shall not be an obligation or duty of the Trustee or Paying Agents.

“*Asset Disposition*” means, with respect to Altice International and the Restricted Subsidiaries (other than the Issuer and the Senior Secured Notes Issuer), any direct or indirect sale, lease (other than an operating lease entered into in the ordinary course of business), transfer, issuance or other disposition, or a series of related sales, leases (other than operating leases entered into in the ordinary course of business), transfers, issuances or dispositions that are part of a common plan, of shares of Capital Stock of a Subsidiary (other than directors’ qualifying shares), property or other assets (each referred to for the purposes of this definition as a “disposition”) by Altice International or any of the Restricted Subsidiaries, including any disposition by means of a merger, consolidation or similar transaction; *provided* that the sale, lease, transfer, issuance or other disposition of all or substantially all of the assets of Altice International and the Restricted Subsidiaries taken as a whole will be governed by the provisions of the Indenture described above under the caption “Change of Control” and/or the provisions described above under the caption “—*Certain Covenants—Merger and Consolidation*” and not by the provisions described under the caption “—*Certain Covenants—Limitation on Sales of Assets and Subsidiary Stock*”. Notwithstanding the preceding provisions of this definition, the following items shall not be deemed to be Asset Dispositions:

- (1) a sale, lease, transfer, issuance or other disposition, or a series of related sales, leases, transfers, issuances or dispositions that are part of a common plan, by a Restricted Subsidiary to Altice International or by Altice International or a Restricted Subsidiary to a Restricted Subsidiary;
- (2) a sale, lease, transfer, issuance or other disposition, or a series of related sales, leases, transfers, issuances or dispositions that are part of a common plan, of cash, Cash Equivalents, Temporary Cash Investments or Investment Grade Securities;
- (3) a sale, lease, transfer, issuance or other disposition, or a series of related sales, leases, transfers, issuances or dispositions that are part of a common plan, of inventory, consumer equipment, trading stock, communications capacity or other assets in the ordinary course of business;
- (4) a sale, lease, transfer, issuance or other disposition, or a series of related sales, leases, transfers, issuances or dispositions that are part of a common plan, of obsolete, surplus or worn out equipment or other assets or equipment or other similar assets that are no longer useful in the conduct of the business of Altice International and its Restricted Subsidiaries;
- (5) transactions permitted under “—*Certain Covenants—Merger and Consolidation*” (other than as permitted under clause (C) of the first paragraph under “—*Certain Covenants—Merger and Consolidation—The Subsidiary Guarantors*”), or a transaction that constitutes a Change of Control;
- (6) an issuance of Capital Stock by a Restricted Subsidiary to Altice International or to another Restricted Subsidiary or as part of or pursuant to an equity incentive or compensation plan approved by the Board of Directors of Altice International;
- (7) (a) any sale, lease, transfer, issuance or other disposition, or any series of related sales, leases, transfers, issuances or dispositions that are part of a common plan, of Capital Stock, properties or assets in a single transaction or series of related transactions with a fair market value (as determined in good faith by the Issuer) not to exceed the greater of €125 million and 1.0% of Total Assets or (b) a transfer of Capital Stock of HOT pursuant to the exercise of a Minority Shareholder Call Option as in effect on December 12, 2012;
- (8) (i) any Restricted Payment that is permitted to be made under the covenant described above under “—*Certain Covenants—Limitation on Restricted Payments*” or (ii) solely for the purposes of the third paragraph under “—*Certain Covenants—Limitation on Sale of Assets and Subsidiary Stock*”, a disposition, the proceeds of which are used to make Restricted Payments permitted to be made under the covenant described above under “—*Certain Covenants—Limitation on Restricted Payments*”;
- (9) the granting of Liens not prohibited by the covenant described above under the caption “—*Certain Covenants—Limitation on Liens*”;
- (10) a sale, lease, transfer, issuance or other disposition, or a series of related sales, leases, transfers, issuances or dispositions that are part of a common plan, of receivables in connection with the compromise, settlement or collection thereof in the ordinary course of business or in bankruptcy or similar proceedings and exclusive of factoring or similar arrangements;

- (11) the licensing or sublicensing of intellectual property or other general intangibles and licenses, sublicenses, leases, subleases of other property, in each case, in the ordinary course of business;
- (12) foreclosure, condemnation or any similar action with respect to any property or other assets;
- (13) the sale or discount (with or without recourse, and on customary or commercially reasonable terms) of accounts receivable or notes receivable arising in the ordinary course of business, or the conversion or exchange of accounts receivable for notes receivable;
- (14) sales, transfers or dispositions of receivables in connection with any Qualified Receivables Financing or any factoring transaction or in the ordinary course of business;
- (15) any sale, lease, transfer, issuance or other disposition, or any series of related sales, leases, transfers, issuances or dispositions that are part of a common plan, of Capital Stock, Indebtedness or other securities of an Unrestricted Subsidiary;
- (16) any sale, lease, transfer, issuance or other disposition, or any series of related sales, leases, transfers, issuances or dispositions that are part of a common plan, of Capital Stock of a Restricted Subsidiary pursuant to an agreement or other obligation with or to a Person (other than Altice International or a Restricted Subsidiary) from whom such Restricted Subsidiary was acquired, or from whom such Restricted Subsidiary acquired its business and assets (having been newly formed in connection with such acquisition), made as part of such acquisition and in each case comprising all or a portion of the consideration in respect of such sale or acquisition;
- (17) any surrender or waiver of contract rights or the settlement, release or surrender of contract, tort or other claims of any kind;
- (18) any sale, lease, transfer, issuance or other disposition, or any series of related sales, leases, transfers, issuances or dispositions that are part of a common plan, of assets to a Person who is providing services related to such assets, the provision of which have been or are to be outsourced by Altice International or any Restricted Subsidiary to such Person; *provided, however*, that the Board of Directors of Altice International shall certify that in the opinion of the Board of Directors, the outsourcing transaction will be economically beneficial to Altice International and the Restricted Subsidiaries (considered as a whole);
- (19) any sale, lease, transfer, issuance or other disposition, or any series of related sales, leases, transfers, issuances or dispositions that are part of a common plan, with respect to property built, owned or otherwise acquired by Altice International or any Restricted Subsidiary pursuant to customary sale and lease-back transactions, asset securitizations and other similar financings permitted by the Indenture; *provided* that network assets of Altice International or any Restricted Subsidiary shall be excluded from this clause (19) unless the Net Cash Proceeds of such sale and leaseback transaction are applied in accordance with the third paragraph of the covenant described under “*Certain Covenants—Limitation on Sales of Assets and Subsidiary Stock*”; and
- (20) any sale, lease, transfer, conveyance or other disposition in one or a series of related transactions of any assets of Altice International and its Subsidiaries or of any Person that becomes a Restricted Subsidiary (including the Target and its Subsidiaries (including the Capital Stock of the Target or any Subsidiary of Altice International or the Target)) that is required pursuant to Competition Laws in relation to the Acquisition or is taken to avoid or eliminate any impediment under Competition Laws in relation to the Acquisition (including, without limitation, in response to any actions initiated by an administrative, regulatory or other governmental authority or private party under Competition Laws) to the extent that the fair market value of any such sold, leased, transferred, conveyed or disposed of assets does not exceed 2.0% of Total Assets (on a pro forma consolidated basis, including, without limitation, the Target and its Subsidiaries that are Restricted Subsidiaries).

“*Associate*” means (i) any Person engaged in a Similar Business of which Altice International or a Restricted Subsidiary are the legal and beneficial owners of between 20% and 50% of all outstanding Voting Stock and (ii) any joint venture engaged in a Similar Business entered into by Altice International or any Restricted Subsidiary.

“*Beneficial Owner*” has the meaning assigned to such term in Rule 13d-3 and Rule 13d-5 under the U.S. Exchange Act, except that in calculating the beneficial ownership of any particular “person” (as that term is used in Section 13(d)(3) of the Exchange Act), such “person” will be deemed to have beneficial ownership of all securities that such “person” has the right to acquire by conversion or exercise of other securities, whether such right is currently exercisable or is exercisable only after the passage of time. The terms “Beneficially Owns” and “Beneficially Owned” have a corresponding meaning.

“*Board of Directors*” means (1) with respect to the Issuer or any corporation, the board of directors or managers, as applicable, of the corporation, or any duly authorized committee thereof; (2) with respect to any partnership, the board of directors or other governing body of the general partner of the partnership or any duly authorized committee thereof; and (3) with respect to any other Person, the board or any duly authorized committee of such Person serving a similar function. Whenever any provision of the Indenture requires any action or determination to be made by, or any approval of, a Board of Directors, such action, determination or approval shall be deemed to have been taken or made if approved by a majority of the directors on any such Board of Directors (whether or not such action or approval is taken as part of a formal board meeting or as a formal board approval).

“*Business Day*” means each day that is not a Saturday, Sunday or other day on which banking institutions in London, United Kingdom, the Grand Duchy of Luxembourg or New York, New York, United States are authorized or required by law to close.

“*Cabovisao*” means Cabovisão—Televisão por Cabo, S.A., a public limited liability company (sociedade anónima) incorporated under the laws of Portugal.

“*Capital Stock*” of any Person means any and all shares of, interests, rights to purchase, warrants or options for, participation or other equivalents of, or partnership or other interests in (however designated), equity of such Person, including any Preferred Stock, but excluding any debt securities convertible into such equity.

“*Capitalized Lease Obligations*” means an obligation that is required to be classified and accounted for as a capitalized lease for financial reporting purposes on the basis of IFRS. The amount of Indebtedness will be, at the time any determination is to be made, the amount of such obligation required to be capitalized on a balance sheet (excluding any notes thereto) prepared in accordance with IFRS, and the stated maturity thereof will be the date of the last payment of rent or any other amount due under such lease prior to the first date such lease may be terminated without penalty. For the avoidance of doubt, operating leases will not be deemed Capitalized Lease Obligations.

“*Cash Equivalents*” means:

- (1) securities issued or directly and fully Guaranteed or insured by the United States Government, the State of Israel, the United Kingdom, Switzerland or any member state of the European Union, in each case, any agency or instrumentality of thereof (*provided* that the full faith and credit of such country or such member state is pledged in support thereof), having maturities of not more than two years from the date of acquisition;
- (2) certificates of deposit, time deposits, eurodollar time deposits, overnight bank deposits or bankers’ acceptances having maturities of not more than one year from the date of acquisition thereof issued by (i) any of Israel Discount Bank Ltd, Mizrahi Tefahot Bank Ltd, Bank Leumi of Israel or Bank Hapoalim Ltd or (ii) a bank or trust company (a) whose commercial paper is rated at least “A-1” or the equivalent thereof by S&P or at least “P-1” or the equivalent thereof by Moody’s (or if at the time neither is issuing comparable ratings, then a comparable rating of another Nationally Recognized Statistical Rating Organization) or (b) (in the event that such bank or trust company does not have commercial paper which is rated) having combined capital and surplus in excess of €500 million;
- (3) repurchase obligations with a term of not more than 30 days for underlying securities of the types described in clauses (1) and (2) entered into with any bank meeting the qualifications specified in clause (2) above;
- (4) commercial paper rated at the time of acquisition thereof at least “A-2” or the equivalent thereof by S&P or “P-2” or the equivalent thereof by Moody’s or carrying an equivalent rating by a Nationally Recognized Statistical Rating Organization, if both of the two named rating agencies cease publishing ratings of investments or, if no rating is available in respect of the commercial paper, the issuer of which has an equivalent rating in respect of its long-term debt, and in any case maturing within one year after the date of acquisition thereof;
- (5) readily marketable direct obligations issued by any state of the United States of America, any member of the European Union or any political subdivision thereof, in each case, having one of the two highest rating categories obtainable from either Moody’s or S&P (or, if at the time, neither is issuing comparable ratings, then a comparable rating of another Nationally Recognized Statistical Rating Organization) with maturities of not more than two years from the date of acquisition;
- (6) Indebtedness or preferred stock issued by Persons with a rating of “BBB-” or higher from S&P or “Baa3” or higher from Moody’s (or, if at the time, neither is issuing comparable ratings, then a comparable rating of another Nationally Recognized Statistical Rating Organization) with maturities of 12 months or less from the date of acquisition;

- (7) bills of exchange issued in the United States, a member state of the European Union, eligible for rediscount at the relevant central bank and accepted by a bank (or any dematerialized equivalent); and
- (8) interests in any investment company, money market or enhanced high yield fund which invests 95% or more of its assets in instruments of the type specified in clauses (1) through (7) above.

“*Change of Control*” means:

- (1) the consummation of any transaction (including, without limitation, any merger or consolidation), the result of which is that any Person (including any “person” (as that term is used in Section 13(d)(3) of the Exchange Act)) other than one or more Permitted Holders becomes the Beneficial Owner, directly or indirectly, of more than 50% of the issued and outstanding Voting Stock of Altice International, measured by voting power rather than number of shares;
- (2) during any period of two consecutive years, individuals who at the beginning of such period constituted the majority of the directors on the Board of Directors of Altice S.A. (together with any new directors whose election by the majority of such directors on such Board of Directors of Altice S.A. or whose nomination for election by shareholders of Altice S.A., as applicable, was approved by a vote of the majority of such directors on the Board of Directors of Altice S.A. then still in office who were either directors at the beginning of such period or whose election or nomination for election was previously so approved) ceased for any reason to constitute the majority of the directors on the Board of Directors of Altice S.A., then in office;
- (3) the direct or indirect sale, lease, transfer, conveyance or other disposition (other than by way of merger, consolidation or other business combination transaction), in one or a series of related transactions, of all or substantially all of the assets of Altice International and its Restricted Subsidiaries, taken as a whole, to a Person (including any “person” as defined above), other than a Permitted Holder; *provided* that a Change of Control shall be deemed not to have occurred as a result of the sale, lease, transfer, conveyance or other disposition in one or a series of related transactions of any assets of Altice International and its Subsidiaries or the Target and its Subsidiaries (including the Capital Stock of the Target or any Subsidiary of Altice International or the Target) that is required pursuant to Competition Laws in relation to the Acquisition or is taken to avoid or eliminate any impediment under Competition Laws in relation to the Acquisition (including, without limitation, in response to any actions initiated by an administrative, regulatory or other governmental authority or private party under Competition Laws); *provided further* that, solely to the extent Altice International is relying on this provision as an exemption from the requirement to make a Change of Control Offer, in the event the fair market value of any such sold, leased, transferred, conveyed or disposed of assets exceeds 2.0% of the Total Assets of Altice International and its Restricted Subsidiaries (on a pro forma consolidated basis, including, without limitation, the Target and its Subsidiaries that are Restricted Subsidiaries), (i) the Consolidated Net Leverage Ratio of Altice International and its Restricted Subsidiaries (on a pro forma consolidated basis, including, without limitation, the Target and its Subsidiaries that are Restricted Subsidiaries and taking into account any repayment or repurchase of Indebtedness pursuant to clause (ii)) shall not increase; and (ii) the Issuer shall promptly make an offer to all holders of the Existing Term Loans, and, to the extent required by the terms of any Pari Passu Indebtedness that is not Public Debt, any such Pari Passu Indebtedness to repay or repurchase such Existing Term Loans and Pari Passu Indebtedness at a price of 100% of the principal amount thereof plus accrued and unpaid interest thereon to the date of redemption in an amount equal to the Net Cash Proceeds of such sale, lease, transfer, conveyance or other disposition (on a *pro rata* basis on the basis of the aggregate principal amount of tendered Existing Term Loans or Pari Passu Indebtedness) and in the event the principal amount Pari Passu Indebtedness tendered is less than the amount of such Net Cash Proceeds, the Issuer shall apply any such remaining proceeds to prepay an equal principal amount of Existing Term Loans at par on a *pro rata* basis; or
- (4) the first day on which the Issuer fails to own, directly or indirectly, 100% of the Capital Stock of the Senior Secured Notes Issuer or Altice International fails to own, directly or indirectly, 100% of the Capital Stock of the Issuer.

“*Change of Control Triggering Event*” means the occurrence of both a Change of Control and a Rating Decline with respect to the Notes.

“*Coditel Holdco*” refers to Coditel Holding Lux II S.à r.l., a private limited liability company (société à responsabilité limitée) incorporated under the laws of Luxembourg.

“*Coditel Intercreditor Agreement*” means the intercreditor agreement, dated November 29, 2011, inter alios, Coditel Holding Lux S.a r.l., Coditel Holding, the companies listed therein as original debtors, ING Bank N.V. as senior agent, Wilmington Trust (London) Limited as mezzanine agent and ING Bank N.V. as security agent.

“*Coditel Senior Credit Facility*” means senior facilities agreement, dated November 29, 2011, inter alios, Coditel Holding Lux S.a r.l. as parent, Coditel Holding as the company, GE Corporate Finance Bank S.A.S., HSBC France, ING Belgium SA/NV, KBC Bank NV and Natixis as mandated lead arrangers ING Bank N.V. as agent and security agent.

“*Commodity Hedging Agreements*” means, in respect of a Person, any commodity purchase contract, commodity futures or forward contract, commodities option contract or other similar contract (including commodities derivative agreements or arrangements), to which such Person is a party or a beneficiary.

“*Competition Laws*” means any federal, state, foreign, multinational or supranational antitrust, competition or trade regulation statutes, rules, regulations, orders, decrees, administrative and judicial doctrines and other laws that are designed or intended to prohibit, restrict or regulate actions or transactions having the purpose or effect of monopolization or restraint of trade or lessening of competition through merger or acquisition or effectuating foreign investment.

“*Completion Date*” means the date on which the Acquisition is consummated.

“*Consolidated EBITDA*” for any period means, without duplication, the Consolidated Net Income for such period, plus the following to the extent deducted in calculating such Consolidated Net Income:

- (1) Consolidated Interest Expense and Receivables Fees;
- (2) Consolidated Income Taxes;
- (3) consolidated depreciation expense;
- (4) consolidated amortization and impairment expense;
- (5) any expenses, charges or other costs related to any Equity Offering, Investment, acquisition (including amounts paid in connection with the acquisition or retention of one or more individuals comprising part of a management team retained to manage the acquired business; *provided* that such payments are made in connection with such acquisition and are consistent with the customary practice in the industry at the time of such acquisition), disposition, recapitalization or the Incurrence of any Indebtedness permitted by the Indenture (whether or not successful) (including any such fees, expenses or charges related to the Original HOT Transactions, the July 2013 Transactions, the December 2013 Transactions and the Transactions), in each case, as determined in good faith by the Issuer;
- (6) any minority interest expense (whether paid or not) consisting of income attributable to minority equity interests of third parties in such period or any prior period or any net earnings, income or share of profit of any Associates, associated company or undertaking;
- (7) the amount of management, monitoring, consultancy and advisory fees and related expenses paid in such period (or accruals relating to such fees and related expenses) to any Permitted Holder (whether directly or indirectly, through any Parent) to the extent permitted by the covenant described under “*Certain Covenants—Limitation on Affiliate Transactions*”; *provided* that any payments for such fees and related expense shall not be included in Consolidated EBITDA for any period to the extent they were accrued for in such period or any prior period and added back to Consolidated EBITDA in such period or any such prior period; and
- (8) other non-cash charges, write-downs or items reducing Consolidated Net Income (excluding any such non-cash charge, write-down or item to the extent it represents an accrual of or reserve for cash charges in any future period) or other non-cash items classified by Altice International as special items less other non-cash items of income increasing Consolidated Net Income (other than any non-cash items increasing such Consolidated Net Income pursuant to clauses (1) through (13) of the definition of Consolidated Net Income and excluding any such non-cash item of income to the extent it represents a receipt of cash in any future period);

provided that for purposes of clause (5)(c)(i) of the first paragraph of the covenant described under “*Certain Covenants—Limitation on Restricted Payments*” only, Consolidated EBITDA shall be the sum of the Consolidated EBITDA of (x) Cool and its Subsidiaries that are Restricted Subsidiaries for the period beginning on the first day of the first full fiscal quarter commencing prior to December 12, 2012 until the New Group Reference Date (defined below) and (y) Altice International and the Restricted Subsidiaries for the period beginning on the first day of the first full fiscal quarter commencing prior to July 2, 2013 (the “New Group Reference Date”) to the relevant date of determination.

“*Consolidated Income Taxes*” means taxes or other payments, including deferred Taxes, based on income, profits or capital of Altice International and the Restricted Subsidiaries whether or not paid, estimated, accrued or required to be remitted to any governmental authority.

“*Consolidated Interest Expense*” means, for any period (in each case, determined on the basis of IFRS), the consolidated net interest income/expense of Altice International and the Restricted Subsidiaries, whether paid or accrued, plus or including (without duplication) any interest, costs and charges consisting of:

- (1) interest expense attributable to Capitalized Lease Obligations;
- (2) amortization of debt discount, but excluding amortization of debt issuance costs, fees and expenses and the expensing of any bridge or other financing fees;
- (3) non-cash interest expense;
- (4) dividends or other distributions in respect of all Disqualified Stock of the Issuer and Altice International and all Preferred Stock of any Restricted Subsidiary, to the extent held by Persons other than Altice International or a Subsidiary of Altice International;
- (5) the consolidated interest expense that was capitalized during such period;
- (6) net payments and receipts (if any) pursuant to Hedging Obligations (other than Currency Agreements) (excluding unrealized mark-to-market gains and losses attributable to Hedging Obligations (other than Currency Agreements)); and
- (7) any interest actually paid by Altice International or any Restricted Subsidiary on Indebtedness of another Person that is guaranteed by Altice International or any Restricted Subsidiary or secured by a Lien on assets of Altice International or any Restricted Subsidiary,

provided that for purposes of clause (c)(i) of the first paragraph of the covenant described under “—*Certain Covenants—Limitation on Restricted Payments*” only, Consolidated Interest Expense shall be the sum of the Consolidated Interest Expense of (x) Cool and its Subsidiaries that are Restricted Subsidiaries for the period beginning on the first day of the first full fiscal quarter commencing prior to the Original Issuer Notes Issue Date until the New Group Reference Date and (y) Altice International and the Restricted Subsidiaries for the period beginning on the New Group Reference Date to the relevant date of determination.

Notwithstanding any of the foregoing, Consolidated Interest Expense shall not include (i) any interest accrued, capitalized or paid in respect of Subordinated Shareholder Funding, (ii) any commissions, discounts, yield and other fees and charges related to a Qualified Receivables Financing, (iii) any payments on any operating leases, including without limitation any payments on any lease, concession or license of property (or Guarantee thereof) which would be considered an operating lease under IFRS as in effect on the Issue Date, (iv) net payments and receipts (if any) pursuant to Currency Agreements (excluding unrealized mark-to-market gains and losses attributable to Hedging Obligations) and (v) any pension liability interest costs.

“*Consolidated Net Income*” means, for any period, the net income (loss) of Altice International and the Restricted Subsidiaries determined on a consolidated basis on the basis of IFRS; *provided, however*, that there will not be included in such Consolidated Net Income:

- (1) subject to the limitations contained in clause (3) below, any net income (loss) of any Person if such Person is not a Restricted Subsidiary, except that Altice International’s equity in the net income of any such Person for such period will be included in such Consolidated Net Income up to the aggregate amount of cash or Cash Equivalents actually distributed by such Person during such period to Altice International or a Restricted Subsidiary as a dividend or other distribution or return on investment (subject, in the case of a dividend or other distribution or return on investment to a Restricted Subsidiary, to the limitations contained in clause (2) below);
- (2) solely for the purpose of determining the amount available for Restricted Payments under clause (c)(i) of the first paragraph of the covenant described under “—*Certain Covenants—Limitation on Restricted Payments*”, any net income (loss) of any Restricted Subsidiary that is not a Guarantor if such Subsidiary is subject to restrictions, directly or indirectly, on the payment of dividends or the making of distributions by such Restricted Subsidiary, directly or indirectly, to Altice International by operation of the terms of such Restricted Subsidiary’s charter or any agreement, instrument, judgment, decree, order, statute or governmental rule or regulation applicable to such Restricted Subsidiary or its shareholders (other than (a) restrictions that have been waived or otherwise released, (b) contractual or legal restrictions in effect on the Issue Date with respect to a

Restricted Subsidiary (including pursuant to the agreements specified in clause (3) of the covenant described under “—*Certain Covenants—Limitation on Restrictions on Distributions from Restricted Subsidiaries*”), and other restrictions with respect to such Restricted Subsidiary that, taken as a whole, are not materially less favorable to the Holders than such restrictions in effect on the Issue Date, and (d) restrictions as in effect on the Issue Date specified in clause (12) of the second paragraph of the covenant described under “—*Certain Covenants—Limitation on Restrictions on Distributions from Restricted Subsidiaries*”) except that Altice International’s equity in the net income of any such Restricted Subsidiary for such period will be included in such Consolidated Net Income up to the aggregate amount of cash or Cash Equivalents or non-cash distributions to the extent converted into cash or Cash Equivalents actually distributed or that could have been distributed by such Restricted Subsidiary during such period to Altice International or another Restricted Subsidiary as a dividend or other distribution (subject, in the case of a dividend to another Restricted Subsidiary, to the limitation contained in this clause);

- (3) any net gain (or loss) realized upon the sale, abandonment or other disposition of any asset or disposed operations of Altice International or any Restricted Subsidiary (including pursuant to any sale/ leaseback transaction) which is not sold or otherwise disposed of in the ordinary course of business (as determined in good faith by an Officer of the Issuer);
- (4) any extraordinary, exceptional, unusual or nonrecurring gain, loss, charge or expense or any charges, expenses or reserves in respect of any restructuring, redundancy or severance or any expenses, charges, reserves, gains or other costs related to the Original HOT Transactions, the July 2013 Transactions, December 2013 Transactions, or the Transactions;
- (5) the cumulative effect of a change in accounting principles;
- (6) any non-cash compensation charge or expense arising from any grant of stock, stock options or other equity based awards and any non-cash deemed finance charges in respect of any pension liabilities or other provisions;
- (7) all deferred financing costs written off and premiums paid or other expenses incurred directly in connection with any early extinguishment of Indebtedness and any net gain (loss) from any write-off or forgiveness of Indebtedness;
- (8) any unrealized gains or losses in respect of Hedging Obligations or other derivative instruments or any ineffectiveness recognized in earnings related to qualifying hedge transactions or the fair value or changes therein recognized in earnings for derivatives that do not qualify as hedge transactions, in each case, in respect of Hedging Obligations or other derivative instruments;
- (9) any unrealized foreign currency translation gains or losses in respect of Indebtedness of any Person denominated in a currency other than the functional currency of such Person and any unrealized foreign exchange gains or losses relating to translation of assets and liabilities denominated in foreign currencies;
- (10) any unrealized foreign currency translation or transaction gains or losses in respect of Indebtedness or other obligations of Altice International or any Restricted Subsidiary owing to Altice International or any Restricted Subsidiary;
- (11) any one-time non-cash charges or any increases in amortization or depreciation resulting from purchase accounting, in each case, in relation to any acquisition of another Person or business or resulting from any reorganization or restructuring involving Altice International or its Subsidiaries;
- (12) any goodwill or other intangible asset impairment charge or write-off; and
- (13) the impact of capitalized, accrued or accreting or pay-in-kind interest or principal on Subordinated Shareholder Funding.

“*Consolidated Net Leverage*” means (A) the sum, without duplication, of the aggregate outstanding Indebtedness of Altice International and its Restricted Subsidiaries on a consolidated basis (excluding (i) Hedging Obligations and (ii) other than for purposes of the covenant described under “—*Certain Covenants—Limitation on Restricted Payments*”, any Indebtedness Incurred pursuant to clause (1) under the second paragraph of the covenant described under “—*Certain Covenants—Limitation on Indebtedness*”), less (B) the aggregate amount of cash and Cash Equivalents of Altice International and the Restricted Subsidiaries on a consolidated basis.

“*Consolidated Net Leverage Ratio*” means, as of any date of determination, the ratio of (x) Consolidated Net Leverage at such date to (y) the aggregate amount of Pro forma EBITDA for the period of the most recent two consecutive fiscal

quarters ending prior to the date of such determination for which internal consolidated financial statements of Altice International are available multiplied by 2.0; *provided, however*, that the *pro forma* calculation of the Consolidated Net Leverage Ratio shall not give effect to (i) any Indebtedness incurred on the date of determination pursuant to the provisions described in the second paragraph under the caption “—*Certain Covenants—Limitation on Indebtedness*” or (ii) the discharge on the date of determination of any Indebtedness to the extent that such discharge results from the proceeds incurred pursuant to the provisions described in the second paragraph under the caption “—*Certain Covenants—Limitation on Indebtedness*”.

For the avoidance of doubt, in determining Consolidated Net Leverage Ratio, no cash or Cash Equivalents shall be included that are the proceeds of Indebtedness in respect of which the calculation of the Consolidated Net Leverage Ratio is to be made.

“*Consolidated Net Senior Secured Leverage*” means (A) the sum of the aggregate outstanding Senior Secured Indebtedness of Altice International and its Restricted Subsidiaries (excluding (i) Hedging Obligations and (ii) other than for purposes of the covenant described under “—*Certain Covenants—Limitation on Restricted Payments*”, Indebtedness Incurred pursuant to clause (1) under the second paragraph of the covenant described under “—*Certain Covenants—Limitation on Indebtedness*”), less (B) the aggregate amount of cash and Cash Equivalents of Altice International and the Restricted Subsidiaries on a consolidated basis.

“*Consolidated Net Senior Secured Leverage Ratio*” means, as of any date of determination, the ratio of (x) Consolidated Net Senior Secured Leverage at such date to (y) the aggregate amount of Pro forma EBITDA for the period of the most recent two consecutive fiscal quarters ending prior to the date of such determination for which internal consolidated financial statements of Altice International are available multiplied by 2.0; *provided, however*, that the *pro forma* calculation of the Consolidated Net Senior Secured Leverage Ratio shall not give effect to (i) any Indebtedness incurred on the date of determination pursuant to the provisions described in the second paragraph under the caption “—*Certain Covenants—Limitation on Indebtedness*” or (ii) the discharge on the date of determination of any Indebtedness to the extent that such discharge results from the proceeds incurred pursuant to the provisions described in the second paragraph under the caption “—*Certain Covenants—Limitation on Indebtedness*”.

For the avoidance of doubt, in determining Consolidated Net Senior Secured Leverage Ratio, no cash or Cash Equivalents shall be included that are the proceeds of Indebtedness in respect of which the calculation of the Consolidated Net Senior Secured Leverage Ratio is to be made.

“*Contingent Obligations*” means, with respect to any Person, any obligation of such Person guaranteeing in any manner, whether directly or indirectly, any operating lease, dividend or other obligation that does not constitute Indebtedness (“primary obligations”) of any other Person (the “primary obligor”), including any obligation of such Person, whether or not contingent:

- (1) to purchase any such primary obligation or any property constituting direct or indirect security therefor;
- (2) to advance or supply funds:
 - (a) for the purchase or payment of any such primary obligation; or
 - (b) to maintain the working capital or equity capital of the primary obligor or otherwise to maintain the net worth or solvency of the primary obligor; or
- (3) to purchase property, securities or services primarily for the purpose of assuring the owner of any such primary obligation of the ability of the primary obligor to make payment of such primary obligation against loss in respect thereof.

“*Cool*” means Cool Holding Ltd., a public limited company (société anonyme) incorporated and existing under the laws of the State of Israel and the Grand Duchy of Luxembourg having its registered office at 3 Boulevard Royal, L-2449 Luxembourg and registered with the Luxembourg Trade and Companies’ Register under number B152.495.

“*Cool Interest Loan*” means the interest free loan from Altice International to Cool in an amount equal to NIS 37 million.

“*Credit Facility*” means, with respect to Altice International or any of its Subsidiaries, one or more debt facilities, arrangements, instruments, trust deeds, note purchase agreements or indentures or commercial paper facilities and overdraft facilities (including the Guarantee Facility, the Senior Credit Facilities and Revolving Credit Facilities) with banks, institutions, funds or investors providing for revolving credit loans, term loans, receivables financing (including through the sale of receivables to such institutions or to special purpose entities formed to borrow from such institutions against such receivables), notes, bonds, debentures letters of credit or other Indebtedness, in each case, as amended,

restated, modified, renewed, refunded, replaced, restructured, refinanced, repaid, increased or extended in whole or in part from time to time (and whether in whole or in part and whether or not with the original administrative agent and lenders or another administrative agent or agents or trustees or other banks, institutions or investors and whether provided under one or more credit or other agreements, indentures, financing agreements or otherwise) and in each case including all agreements, instruments and documents executed and delivered pursuant to or in connection with the foregoing (including any notes and letters of credit issued pursuant thereto and any Guarantee and collateral agreement, patent and trademark security agreement, mortgages or letter of credit applications and other Guarantees, pledges, agreements, security agreements and collateral documents). Without limiting the generality of the foregoing, the term “Credit Facility” shall include any agreement or instrument (1) changing the maturity of any Indebtedness Incurred thereunder or contemplated thereby, (2) adding Subsidiaries of Altice International as additional borrowers or guarantors thereunder, (3) increasing the amount of Indebtedness Incurred thereunder or available to be borrowed thereunder or (4) otherwise altering the terms and conditions thereof.

“*Currency Agreement*” means, in respect of a Person, any foreign exchange contract, currency swap agreement, currency futures contract, currency option contract, cap, floor, ceiling, collar, currency derivative or other similar agreement to which such Person is a party or beneficiary.

“*December 2013 Senior Notes*” refers to the \$400 million aggregate principal amount of the Issuer’s 8¹/₈% Senior Notes due 2024 issued on December 12, 2013.

“*December 2013 Senior Notes Indenture*” means the indenture dated as of December 12, 2013, as amended, restated, supplemented or otherwise modified from time to time, among, inter alios, the Issuer, as issuer, the guarantors party thereto and the trustee party thereto, governing the December 2013 Senior Notes.

“*December 2013 Transactions*” refers to the acquisition of Orange Dominicana (which was consummated on April 9, 2014), the acquisition of the Tricom Entities (which was consummated on March 12, 2014), and the related issuance of the December 2013 Senior Notes and Existing Senior Secured Notes issued on December 12, 2013.

“*Default*” means any event which is, or after giving notice or with the passage of time or both would be, an Event of Default.

“*Designated Non-Cash Consideration*” means the fair market value (as determined in good faith by the Issuer) of non-cash consideration received by Altice International or a Restricted Subsidiary in connection with an Asset Disposition that is so designated as Designated Non-Cash Consideration pursuant to an Officer’s Certificate, setting forth the basis of such valuation, less the amount of cash, Cash Equivalents or Temporary Cash Investments received in connection with a subsequent payment, redemption, retirement, sale or other disposition of such Designated Non-Cash Consideration. A particular item of Designated Non-Cash Consideration will no longer be considered to be outstanding when and to the extent it has been paid, redeemed or otherwise retired or sold or otherwise disposed of in compliance with the covenant described under “—*Certain Covenants—Limitation on Sales of Assets and Subsidiary Stock*”.

“*Designated Preference Shares*” means, with respect to Altice International, Preferred Stock (other than Disqualified Stock) (a) that is issued for cash (other than to Altice International or a Subsidiary of Altice International or an employee stock ownership plan or trust established by Altice International or any such Subsidiary for the benefit of their employees to the extent funded by Altice International or such Subsidiary) and (b) that is designated as “Designated Preference Shares” pursuant to an Officer’s Certificate of the Issuer at or prior to the issuance thereof, the Net Cash Proceeds of which are excluded from the calculation set forth in clause (c)(ii) of the first paragraph of the covenant described under “—*Certain Covenants—Limitation on Restricted Payments*”.

“*Designated Senior Debt*” means (1) any Senior Indebtedness permitted to be Incurred under the Indenture that has, at the time of designation, an aggregate principal amount outstanding of at least € 40.0 million (including the amount of all undrawn commitments and matured and contingent reimbursement obligations pursuant to letters of credit thereunder) and that has been designated by the Issuer in an instrument evidencing such Senior Indebtedness and in an Officer’s Certificate delivered to the Trustee as “Designated Senior Indebtedness” for purposes of the Indenture, (2) all Indebtedness arising under the Revolving Credit Facilities, (3) all Indebtedness arising under the Senior Secured Notes Indentures and the Senior Secured Notes and Guarantees thereof, (4) all Indebtedness arising under the Senior Credit Facilities, the loans thereunder and Guarantees thereof and (5) all Indebtedness arising under the Guarantee Facility.

“*Disinterested Director*” means, with respect to any Affiliate Transaction, a member of the Board of Directors of Altice International having no material direct or indirect financial interest in or with respect to such Affiliate Transaction. A member of the Board of Directors of Altice International shall be deemed not to have such a financial interest by reason of such member’s holding Capital Stock of Altice International or any Parent or any options, warrants or other rights in respect of such Capital Stock.

“*Disqualified Stock*” means, with respect to any Person, any Capital Stock of such Person which by its terms (or by the terms of any security into which it is convertible or for which it is exchangeable) or upon the happening of any event:

- (1) matures or is mandatorily redeemable for cash or in exchange for Indebtedness pursuant to a sinking fund obligation or otherwise;
- (2) is convertible or exchangeable for Indebtedness or Disqualified Stock (excluding Capital Stock which is convertible or exchangeable solely at the option of Altice International or a Restricted Subsidiary); or
- (3) is or may become (in accordance with its terms) upon the occurrence of certain events or otherwise redeemable or repurchasable for cash or in exchange for Indebtedness at the option of the holder of the Capital Stock in whole or in part,

in each case, on or prior to the earlier of (a) the Stated Maturity of the Notes or (b) the date on which there are no Notes outstanding; *provided, however*, that (i) only the portion of Capital Stock which so matures or is mandatorily redeemable, is so convertible or exchangeable or is so redeemable at the option of the holder thereof prior to such date will be deemed to be Disqualified Stock and (ii) any Capital Stock that would constitute Disqualified Stock solely because the holders thereof have the right to require Altice International to repurchase such Capital Stock upon the occurrence of a change of control or asset sale (howsoever defined or referred to) shall not constitute Disqualified Stock if any such redemption or repurchase obligation is subject to compliance by the relevant Person with the covenant described under “—*Certain Covenants—Limitation on Restricted Payments*”.

“*Equity Offering*” means a public or private sale of (x) Capital Stock of Altice International or (y) Capital Stock or other securities, the proceeds of which are contributed as Subordinated Shareholder Funding or to the equity of Altice International or any of its Restricted Subsidiaries, in each case other than:

- (1) Disqualified Stock;
- (2) Designated Preference Shares;
- (3) offerings registered on Form S-8 (or any successor form) under the Securities Act or any similar offering in other jurisdictions;
- (4) any such sale to an Affiliate of Altice International, including the Issuer, Altice International or a Restricted Subsidiary;
- (5) any such sale that constitutes an Excluded Contribution; and
- (6) the AI Mandatory Convertible Notes.

“*Escrow Agent*” means Deutsche Bank AG, London Branch.

“*Escrow Agreements*” means the New Senior Notes Escrow Agreement and the Notes Escrow Agreement.

“*Escrow Assignments*” means the grant of security interests in the Escrow Account and the Issuer’s rights under the Notes Escrow Agreement on the Issue Date to the Trustee for the benefit of the Holders of the relevant series of Notes.

“*Escrowed Proceeds*” means the proceeds from the offering of any debt securities or other Indebtedness paid into an escrow account with an independent escrow agent on the date of the applicable offering or Incurrence pursuant to escrow arrangements that permit the release of amounts on deposit in such escrow account upon satisfaction of certain conditions or the occurrence of certain events. The term “*Escrowed Proceeds*” shall include any interest earned on the amounts held in escrow.

“*euro*” or “*€*” means the currency introduced at the start of the third stage of the European economic and monetary union pursuant to the Treaty establishing the European Community, as amended by the Treaty on European Union.

“*Euro Equivalent*” means, with respect to any monetary amount in a currency other than euro (“*Other Currency*”), at any time of determination thereof by the Issuer or the Trustee, the amount of euros obtained by converting such Other Currency involved in such computation into euros at the spot rate for the purchase of euros with the Other Currency as published in *The Financial Times* in the “*Currency Rates*” section (or, if *The Financial Times* is no longer published, or if such information is no longer available in *The Financial Times*, such source as may be selected in good faith by the Issuer) on the date of such determination.

“*European Government Obligations*” means direct obligations of, or obligations guaranteed by, a member state of the European Monetary Union as of the date of the Indenture, and the payment for which such member state of the European Monetary Union pledges its full faith and credit; provided that such member state has a long-term government debt rating of “A1” or higher by Moody’s or “A+” or higher by S&P or the equivalent rating category of another internationally recognized rating agency.

“*Exchange Act*” means the U.S. Securities Exchange Act of 1934, as amended, and the rules and regulations of the SEC promulgated thereunder, as amended.

“*Excluded Contribution*” means Net Cash Proceeds or property or assets received by Altice International as capital contributions to the equity (other than through the issuance of Disqualified Stock or Designated Preference Shares of Altice International) after the Issue Date or from the issuance or sale (other than to Altice International, a Restricted Subsidiary or an employee stock ownership plan or trust established by Altice International or any Subsidiary of Altice International for the benefit of its employees to the extent funded by Altice International or any Restricted Subsidiary) of Capital Stock (other than Disqualified Stock, Designated Preference Shares) or Subordinated Shareholder Funding of Altice International, in each case, to the extent designated as an Excluded Contribution pursuant to an Officer’s Certificate of the Issuer.

“*Existing ASA Notes*” refers to the \$2,900 million aggregate principal amount of Altice S.A.’s 7³/₄% Senior Notes due 2022 and €2,075 million aggregate principal amount of Altice S.A.’s 7¹/₄% Senior Notes, in each case, issued on May 8, 2013.

“*Existing ASA Revolving Credit Facility*” means the revolving credit facility agreement dated on or around May 8, 2013, as amended, restated, supplemented or otherwise modified from time to time, between, *inter alia*, Altice S.A., certain financial institutions party thereto and Deutsche Bank AG, London Branch as facility agent and Deutsche Bank AG, London Branch, as security agent.

“*Existing HOT Unsecured Notes*” refers to the NIS 825 million notes (Series A) and the NIS 675 million notes (Series B) of HOT, offered to the Israeli investors pursuant to an Israeli shelf offering report dated March 29, 2011 under an Israeli shelf prospectus dated February 28, 2011, as amended on March 29, 2011, and as shall be amended from time to time.

“*Existing Revolving Credit Facilities*” means (i) that certain agreement dated November 27, 2012, as amended, restated, supplemented or otherwise modified from time to time, between, *inter alia*, the Issuer, the Company, certain financial institutions party thereto and Citibank International plc as facility agent and security agent, as amended and (ii) the 2013 Revolving Credit Facility.

“*Existing Senior Credit Facility*” means the term loan credit agreement dated June 24, 2013 between the Senior Secured Notes Issuer as borrower and the persons listed in Schedule 2.01 thereto as lenders, Goldman Sachs Lending Partners LLC as the Administrative Agent and Citibank, N.A., London Branch as Security Agent, as amended.

“*Existing Senior Notes*” means, collectively, the December 2013 Senior Notes, the July 2013 Issuer Notes, and the Original Issuer Notes.

“*Existing Senior Notes Indentures*” means, collectively, the December 2013 Senior Notes Indenture, the July 2013 Issuer Notes Indenture and the Original Issuer Notes Indenture.

“*Existing Senior Secured Notes*” means, collectively, the € 210 million aggregate principal amount of 8% senior secured notes due 2019, the \$460 million aggregate principal amount of 7⁷/₈% senior secured notes due 2019, the \$900 million aggregate principal amount of 6¹/₂% Senior Secured Notes due 2022, and €300 million aggregate principal amount of 6¹/₂% Senior Secured Notes, each issued by the Senior Secured Notes Issuer.

“*Existing Senior Secured Notes Indentures*” means, collectively, the indenture dated as of December 12, 2012 and the indenture dated as of December 12, 2013, each as amended, among, *inter alios*, the Senior Secured Notes Issuer, as Issuer, the guarantors party thereto and the trustee and security agent party thereto, governing the applicable Existing Senior Secured Notes.

“*Existing Term Loans*” means the term loans extended to the Issuer pursuant to the Existing Senior Credit Facility.

“*fair market value*” wherever such term is used in this “Description of Senior Notes” or the Indenture (except in relation to an enforcement action pursuant to the Intercreditor Agreement and except as otherwise specifically provided in this “Description of Senior Notes” or the Indenture), may be conclusively established by means of an Officer’s Certificate or a resolution of the Board of Directors of Altice International setting out such fair market value as determined by such Officer or such Board of Directors in good faith.

“*Finco Asset Disposition*” means the sale, lease, conveyance or other disposition of any rights, property or assets by the Issuer or the Senior Secured Notes Issuer. Notwithstanding the preceding, none of the following items will be deemed to be a Finco Asset Disposition:

- (1) the granting of a Permitted Issuer Lien or a Permitted Senior Secured Notes Issuer Lien;
- (2) any Permitted Issuer Investment or a Permitted Senior Secured Notes Issuer Investment; and
- (3) the sale or other disposition of cash or Cash Equivalents.

“*Global Interlink*” means Global Interlink Ltd., a private limited company incorporated under the laws of the Bahamas.

“*Green*” means green.ch AG (company registration no. CHE-112.574.742; formerly Solution25 AG), a Swiss company limited by shares (*Aktiengesellschaft*), incorporated and existing under the laws of Switzerland.

“*Green Datacenter*” means Green Datacenter AG (company registration no. CHE-115.555.342), a Swiss company limited by shares (*Aktiengesellschaft*) incorporated and existing under the laws of Switzerland.

“*Group*” means Altice International and its Subsidiaries.

“*Guarantee*” means any obligation, contingent or otherwise, of any Person directly or indirectly guaranteeing any Indebtedness of any other Person, including any such obligation, direct or indirect, contingent or otherwise, of such Person:

- (1) to purchase or pay (or advance or supply funds for the purchase or payment of) such Indebtedness of such other Person (whether arising by virtue of partnership arrangements, or by agreements to keep-well, to purchase assets, goods, securities or services, to take-or-pay or to maintain financial statement conditions or otherwise); or
- (2) entered into primarily for purposes of assuring in any other manner the obligee of such Indebtedness of the payment thereof or to protect such obligee against loss in respect thereof (in whole or in part),

provided, however, that the term “Guarantee” will not include endorsements for collection or deposit in the ordinary course of business or any guarantee of performance. The term “Guarantee” used as a verb has a corresponding meaning.

“*Guarantee Facility*” means the guarantee facility agreement dated July 1, 2013, as amended, restated, supplemented or otherwise modified from time to time, among the Senior Secured Notes Issuer as borrower, the lenders from time to time party thereto, Citibank International Plc as facility agent and Citibank, N.A., London Branch as Security Agent.

“*Guarantors*” means (i) as of the Completion Date, the Completion Date Guarantors, (ii) as of the Post-Completion Guarantor Accession Date, the Completion Date Guarantors and the Post-Completion Date Guarantors and (iii) each Person that executes a Note Guarantee in accordance with the provisions of the Indenture in its capacity as a guarantor of the Notes and its respective successors and assigns, until the Note Guarantee of such Person has been released in accordance with the provisions of the Indenture.

“*Hedging Obligations*” of any Person means the obligations of such Person pursuant to any Interest Rate Agreement, Currency Agreement or Commodity Hedging Agreement.

“*Holder*” means each Person in whose name the Notes are registered.

“*HOT Credit Facility*” means the Facility Agreement dated April 25, 2013 between and made between (among others) HOT and HSBC Bank plc, Israel Discount Bank Ltd. and First International Bank of Israel Ltd. in their respective capacities as Lenders.

“*HOT Direct Obligation Event*” means the election by Altice International to cause HOT and the HOT Proceeds Note Obligors to become direct Guarantors of the Senior Secured Notes by causing each of them to provide a Guarantee of the Senior Secured Notes on a senior basis and grant an equivalent Lien over all of its assets; *provided* that where a Guarantee by a Restricted Subsidiary of HOT could reasonably be expected to give rise to or result in: (1) any violation of applicable law or regulation; (2) any liability for the officers, directors or (except in the case of a Restricted Subsidiary that is a partnership) shareholders of such Restricted Subsidiary (or, in the case of a Restricted Subsidiary that is a partnership, directors or shareholders of the partners of such partnership); (3) any cost, expense, liability or obligation (including with respect to any Taxes) other than reasonable out-of-pocket expenses and other than reasonable expenses

incurred in connection with any governmental or regulatory filings required as a result of, or any measures pursuant to clause (1) hereof undertaken in connection with, such Guarantee, which in any case under any of clauses (1), (2) and (3) of this paragraph cannot be avoided through measures reasonably available to Altice International, HOT or such Restricted Subsidiary; or (4) such Restricted Subsidiary is prohibited from Incurring such Guarantee by the terms of any Indebtedness of such Restricted Subsidiary that is not prepayable without a prepayment premium (in each case, other than Indebtedness Incurred to provide all or any portion of the funds utilized to consummate the transaction or series of related transactions pursuant to which such Person became a Restricted Subsidiary) (*provided* that this clause (4) applies only for so long as such prepayment premium applies to such Indebtedness), such Restricted Subsidiary shall be excluded from the requirement to provide such Guarantee and grant a Lien over its assets as a condition to the consummation of the HOT Direct Obligation Event.

“*HOT Mobile*” means HOT Mobile Ltd., formerly known as MIRS Communications Ltd.

“*HOT Proceeds Note*” means collectively, the proceeds term loan and the revolving facility proceeds loan made by the Senior Secured Notes Issuer to HOT on December 27, 2012.

“*HOT Proceeds Note Collateral*” means the rights, property and assets securing the HOT Proceeds Note and the HOT Proceeds Note Guarantees and any rights, property or assets over which a Lien has been granted to secure the Obligations of HOT and the HOT Proceeds Note Guarantors under the HOT Proceeds Note.

“*HOT Proceeds Note Documents*” means the HOT Proceeds Note and the HOT Security Documents.

“*HOT Proceeds Note Guarantee*” means the guarantee by each HOT Proceeds Note Guarantor of the HOT’s obligations under the HOT Proceeds Note, executed pursuant to the provisions thereof and the Senior Secured Notes Indentures.

“*HOT Proceeds Note Guarantor*” means each Person that accedes to the HOT Proceeds Note as a HOT Proceeds Note Guarantor in accordance with the provisions of the HOT Proceeds Note and the Indenture in its capacity as a guarantor of the HOT Proceeds Note and its respective successors and assigns, until the HOT Proceeds Note Guarantee of such Person has been released in accordance with the provisions of the Indenture.

“*HOT Proceeds Note Obligor*” means HOT and the HOT Proceeds Notes Guarantors.

“*HOT Security Documents*” means the security agreements, pledge agreements, collateral assignments, and any other instrument and document executed and delivered pursuant to the HOT Proceeds Note or otherwise or any of the foregoing, as the same may be amended, supplemented or otherwise modified from time to time, creating the security interests in the HOT Proceeds Note Collateral as contemplated by the Indenture and the HOT Proceeds Note.

“*IFRS*” means International Financial Reporting Standards as issued by the International Accounting Standards Board or any successor board or agency as endorsed by the European Union and in effect on the date hereof, or, with respect to the covenant described under the caption “Reports” as in effect from time to time; *provided that* at any date after the Issue Date, Altice International may make an irrevocable election to establish that “IFRS” shall mean IFRS as in effect on a date that is on or prior to the date of such election.

“*Incur*” means issue, create, assume, enter into any Guarantee of, incur, extend or otherwise become liable for; *provided, however,* that any Indebtedness or Capital Stock of a Person existing at the time such Person becomes a Restricted Subsidiary (whether by merger, consolidation, acquisition or otherwise) will be deemed to be Incurred by Altice International or such Restricted Subsidiary at the time it becomes a Restricted Subsidiary and the terms “*Incurred*” and “*Incurrence*” have meanings correlative to the foregoing and any Indebtedness pursuant to any Credit Facility, bridge facility, revolving credit or similar facility shall only be “*Incurred*” at the time any funds are borrowed thereunder.

“*Indebtedness*” means, with respect to any Person on any date of determination (without duplication):

- (1) the principal of indebtedness of such Person for borrowed money;
- (2) the principal of obligations of such Person evidenced by bonds, debentures, notes or other similar instruments;
- (3) all reimbursement obligations of such Person in respect of letters of credit, bankers’ acceptances or other similar instruments (the amount of such obligations being equal at any time to the aggregate then undrawn and unexpired amount of such letters of credit or other instruments plus the aggregate amount of drawings thereunder that have not been reimbursed) (except to the extent such reimbursement obligations relate to trade payables and such obligations are satisfied within 30 days of Incurrence), in each case only to the extent that the underlying obligation in respect of which the instrument was issued would be treated as Indebtedness;

- (4) the principal component of all obligations of such Person to pay the deferred and unpaid purchase price of assets acquired or services supplied (except trade payables), which purchase price is due more than one year after the date of placing such property in service or taking final delivery and title thereto;
- (5) [Reserved];
- (6) the principal component of all obligations, or liquidation preference, of such Person with respect to any Disqualified Stock or, with respect to any Restricted Subsidiary, any Preferred Stock (but excluding, in each case, any accrued dividends);
- (7) the principal component of all Indebtedness of other Persons secured by a Lien on any asset of such Person, whether or not such Indebtedness is assumed by such Person; *provided, however*, that the amount of such Indebtedness will be the lesser of (a) the fair market value of such asset at such date of determination (as determined in good faith by the Issuer) and (b) the amount of such Indebtedness of such other Persons;
- (8) Guarantees by such Person of the principal component of Indebtedness of other Persons to the extent Guaranteed by such Person; and
- (9) to the extent not otherwise included in this definition, net obligations of such Person under Currency Agreements, Commodity Hedging Agreements and Interest Rate Agreements (the amount of any such obligations to be equal at any time to the termination value of such agreement or arrangement giving rise to such obligation that would be payable by such Person at such time),

The term “Indebtedness” shall not include (i) Subordinated Shareholder Funding, (ii) any lease (including for avoidance of doubt, any network lease or any Operating IRU), concession or license of property (or Guarantee thereof) which would be considered an operating lease under IFRS as in effect on December 12, 2012 or the Issue Date, (iii) prepayments of deposits received from clients or customers in the ordinary course of business, (iv) any pension obligations, (v) Contingent Obligations, (vi) obligations under or in respect of Qualified Receivables Financing, (vii) obligations under any license, permit or other approval (or Guarantees given in respect of such obligations) Incurred prior to the Issue Date or in the ordinary course of business, (viii) non-interest bearing installment obligations and accrued liabilities Incurred in the ordinary course of business that are not more than 120 days past due, (ix) Indebtedness in respect of the Incurrence by Altice International or any Restricted Subsidiary of Indebtedness in respect of standby letters of credit, performance bonds or surety bonds provided by Altice International or any Restricted Subsidiary in the ordinary course of business to the extent such letters of credit or bonds are not drawn upon or, if and to the extent drawn upon are honored in accordance with their terms and if, to be reimbursed, are reimbursed no later than the fifth Business Day following receipt by such Person of a demand for reimbursement following payment on the letter of credit or bond, and (x) Indebtedness Incurred by Altice International or a Restricted Subsidiary in connection with a transaction where (A) such Indebtedness is borrowed from a bank or trust company, having a combined capital and surplus and undivided profits of not less than €250 million, whose debt has a rating immediately prior to the time such transaction is entered into, of at least A or the equivalent thereof by S&P and A2 or the equivalent thereof by Moody’s and (B) a substantially concurrent Investment is made by Altice International or a Restricted Subsidiary in the form of cash deposited with the lender of such Indebtedness, or a Subsidiary or Affiliate thereof, in amount equal to such Indebtedness. For the avoidance of doubt and notwithstanding the above, the term “Indebtedness” excludes any accrued expenses and trade payables, any obligations under guarantees issued in connection with various operating and telecommunications licenses, any obligations under the guarantee by HOT issued to the Ministry of Communications and Broadcast Council in connection with various operating and broadcasting licenses, including the bank guarantee in connection with the HOT Mobile’s winning a frequency allotment and receiving a cellular license, and any obligations of HOT Systems towards the State of Israel under an agreement dated July 10, 2001, between HOT Systems and other cable companies and between the State of Israel, in each case, as in effect on December 12, 2012.

The amount of Indebtedness of any Person at any time in the case of a revolving credit or similar facility shall be the total amounts of funds borrowed and then outstanding. The amount of Indebtedness of any Person at any date shall be determined as set forth above or otherwise provided in the Indenture, and (other than with respect to letters of credit or Guarantees or Indebtedness specified in clause (7), (8) or (9) above) shall equal the amount thereof that would appear on a balance sheet of such Person (excluding any notes thereto) prepared on the basis of IFRS.

Notwithstanding the above provisions, in no event shall the following constitute Indebtedness:

- (i) in connection with the purchase by Altice International or any Restricted Subsidiary of any business, any post-closing payment adjustments to which the seller may become entitled to the extent such payment is determined by a final closing balance sheet or such payment depends on the performance of such business after the closing; *provided, however*, that, at the time of closing, the amount of any such payment is not determinable

and, to the extent such payment thereafter becomes fixed and determined, the amount is paid within 30 days thereafter;

- (ii) for the avoidance of doubt, any obligations in respect of workers' compensation claims, early retirement or termination obligations, pension fund obligations or contributions or similar claims, obligations or contributions or social security or wage Taxes;
- (iii) parallel debt obligations, to the extent such obligations mirror other Indebtedness; or
- (iv) Capitalized Lease Obligations.

“*Independent Financial Advisor*” means an investment banking or accounting firm of international standing or any third party appraiser of international standing; *provided, however*, that such firm or appraiser is not an Affiliate of the Issuer.

“*Initial Public Offering*” means the Equity Offering of common stock or other common equity interests of Altice S.A., which was completed on February 5, 2014, as a result of which, the shares of common stock or other common equity interests of Altice S.A. in such offering are listed on the Euronext Amsterdam.

“*Intercreditor Agreement*” means the intercreditor agreement dated December 12, 2012 and made between (among others) the Issuer, the Senior Secured Notes Issuer, the Guarantors, the Security Agent, the Facility Agent, the Mandated Lead Arrangers (as defined therein), certain financial institutions party thereto, the Hedging Banks (as defined therein) and the trustee for the Existing Senior Notes, as amended, and to which the Trustee is expected to accede to on the Completion Date.

“*Interest Rate Agreement*” means, with respect to any Person, any interest rate protection agreement, interest rate future agreement, interest rate option agreement, interest rate swap agreement, interest rate cap agreement, interest rate collar agreement, interest rate hedge agreement or other similar agreement or arrangement to which such Person is party or a beneficiary.

“*Investment*” means, with respect to any Person, all investments by such Person in other Persons (including Affiliates) in the form of any direct or indirect advance, loan or other extensions of credit (other than advances or extensions of credit to customers, suppliers, directors, officers or employees of any Person in the ordinary course of business, and excluding any debt or extension of credit represented by a bank deposit other than a time deposit) or capital contribution to (by means of any transfer of cash or other property to others or any payment for property or services for the account or use of others), or the Incurrence of a Guarantee of any obligation of, or any purchase or acquisition of Capital Stock, Indebtedness or other similar instruments issued by, such other Persons and all other items that are or would be classified as investments on a balance sheet (excluding any notes thereto) prepared on the basis of IFRS; *provided, however*, that endorsements of negotiable instruments and documents in the ordinary course of business will not be deemed to be an Investment. If Altice International or any Restricted Subsidiary issues, sells or otherwise disposes of any Capital Stock of a Person that is a Restricted Subsidiary such that, after giving effect thereto, such Person is no longer a Restricted Subsidiary, any Investment by Altice International or any Restricted Subsidiary in such Person remaining after giving effect thereto will be deemed to be a new Investment equal to the fair market value of the Capital Stock of such Subsidiary not sold or disposed of in an amount determined as provided in the final paragraph of the covenant described above under the caption “—*Certain Covenants—Limitation on Restricted Payments*”.

For purposes of “—*Certain Covenants—Limitation on Restricted Payments*”:

- (1) “Investment” will include the portion (proportionate to Altice International’s equity interest in a Restricted Subsidiary to be designated as an Unrestricted Subsidiary) of the fair market value of the net assets of such Restricted Subsidiary at the time that such Restricted Subsidiary is designated an Unrestricted Subsidiary; *provided, however*, that upon a redesignation of such Subsidiary as a Restricted Subsidiary, Altice International will be deemed to continue to have a permanent “Investment” in an Unrestricted Subsidiary in an amount (if positive) equal to (a) Altice International’s “Investment” in such Subsidiary at the time of such redesignation less (b) the portion (proportionate to Altice International’s equity interest in such Subsidiary) of the fair market value of the net assets (as conclusively determined by an Officer or the Board of Directors of Altice International in good faith) of such Subsidiary at the time that such Subsidiary is so re-designated a Restricted Subsidiary; and
- (2) any property transferred to or from an Unrestricted Subsidiary will be valued at its fair market value at the time of such transfer (or if earlier at the time of entering into an agreement to sell such property), in each case as determined in good faith by an Officer or the Board of Directors of Altice International.

The amount of any Investment outstanding at any time shall be the original cost of such Investment, reduced (at the Issuer's option) by any dividend, distribution, interest payment, return of capital, repayment or other amount or value received in respect of such Investment.

“*Investment Grade Securities*” means:

- (1) securities issued or directly and fully Guaranteed or insured by the United States or Canadian government or any agency or instrumentality thereof (other than Cash Equivalents);
- (2) securities issued or directly and fully guaranteed or insured by a member state of the European Union, Switzerland, Norway or any agency or instrumentality thereof (other than Cash Equivalents);
- (3) debt securities or debt instruments with a rating of “A” or higher from S&P or “A3” or higher by Moody’s or the equivalent of such rating by such rating organization or, if no rating of Moody’s or S&P then exists, the equivalent of such rating by any other Nationally Recognized Statistical Ratings Organization, but excluding any debt securities or instruments constituting loans or advances among Altice International and its Subsidiaries; and
- (4) investments in any fund that invests exclusively in investments of the type described in clauses (1), (2) and (3) above which fund may also hold cash and Cash Equivalents pending investment or distribution.

“*Investment Grade Status*” shall occur when the Notes receive both of the following:

- (1) a rating of “BBB–” or higher from S&P; and
- (2) a rating of “Baa3” or higher from Moody’s,

or the equivalent of such rating by either such rating organization or, if no rating of Moody’s or S&P then exists, the equivalent of such rating by any other Nationally Recognized Statistical Ratings Organization.

“*Investor*” means the ultimate controlling shareholder of Altice S.A. on the Issue Date.

“*Investor Affiliate*” means (i) the Investor or any of his immediate family members, and any such persons’ respective Affiliates and direct and indirect Subsidiaries, (ii) any sponsor, limited partnerships or entities managed or controlled by the Investor or any of his immediate family, or any of such persons’ respective Affiliates and direct or indirect Subsidiaries, (iii) any trust of the Investor or any of his immediate family, or any of such persons’ respective Affiliates and direct or indirect Subsidiaries or any trust in respect of which any such persons is a trustee, (iv) any partnership of which the Investor or any of his immediate family, or any of such persons’ respective Affiliates or direct or indirect Subsidiaries is a partner that is managed or controlled by the Investor, any of his immediate family or any of such persons’ respective Affiliates or direct or indirect Subsidiaries, and (v) any trust, fund or other entity which is managed by, or is under the control of, the Investor or any of his immediate family, or any of such persons’ respective Affiliates or direct or indirect Subsidiaries, but excluding Altice International or any of its Subsidiaries.

“*IPO Market Capitalization*” means an amount equal to (i) the total number of issued and outstanding shares of common stock or common equity interests of Altice S.A. at the time of closing of the Initial Public Offering multiplied by (ii) the price per share at which such shares of common stock or common equity interests are sold in such Initial Public Offering.

“*Issue Date*” means February 4, 2015.

“*Issuer*” means Altice Finco S.A., a Luxembourg public limited liability company (*société anonyme*) with registered office at 3 Boulevard Royal, L-2449 Luxembourg and registered with the Luxembourg Trade and Companies’ Register under number B171.151.

“*July 2013 Issuer Notes*” refers to the €250 million aggregate principal amount of the Issuer’s 9% Senior Notes due 2023 issued on June 14, 2013 and released from escrow on July 2, 2013.

“*July 2013 Issuer Notes Indenture*” means the indenture dated as of June 19, 2013, as amended, among, *inter alios*, HoldCo, as issuer, the guarantors party thereto and the trustee and security agent party thereto, governing the July 2013 Issuer Notes.

“*July 2013 Transactions*” means the transactions described under “The Transactions” in the offering memorandum dated June 19, 2013 relating to the July 2013 Issuer Notes.

“*Knewon*” means Knewon, S.A., a public limited liability company (*sociedade anónima*) incorporated under the laws of Portugal.

“*Lien*” means any mortgage, pledge, security interest, encumbrance, lien or charge of any kind (including any conditional sale or other title retention agreement or lease in the nature thereof).

“*Management Advances*” means loans or advances made to, or Guarantees with respect to loans or advances made to, directors, officers, employees or consultants of any Parent, Altice International or any Restricted Subsidiary:

- (1) (a) in respect of travel, entertainment or moving related expenses Incurred in the ordinary course of business or (b) for purposes of funding any such Person’s purchase of Capital Stock or Subordinated Shareholder Funding (or similar obligations) of Altice International, its Restricted Subsidiaries or any Parent (i) not to exceed an amount (net of repayments of any such loans or advances) equal to €10 million in any calendar year (with unused amounts in any calendar year being carried over to the succeeding calendar years; *provided* that the aggregate Management Advances made under this sub-clause (b)(i) do not exceed €20 million in any fiscal year) or (ii) with the approval of the Board of Directors of Altice S.A.;
- (2) in respect of moving related expenses Incurred in connection with any closing or consolidation of any facility or office; or
- (3) (in the case of this clause (3)) not exceeding €7.5 million in the aggregate outstanding at any time.

“*Management Investors*” means the current or former officers, directors, employees and other members of the management of or consultants to any Parent, Altice International or any of their respective Subsidiaries (including, without limitation, the Target), or spouses, family members or relatives thereof, or any trust, partnership or other entity for the benefit of or the beneficial owner of which (directly or indirectly) is any of the foregoing, or any of their heirs, executors, successors and legal representatives, who at any date beneficially own or have the right to acquire, directly or indirectly, Capital Stock of Altice International, any Restricted Subsidiary or any Parent.

“*Market Capitalization*” means an amount equal to (i) the total number of issued and outstanding shares of common stock or common equity interests of Altice S.A. on the date of the declaration of the relevant dividend multiplied by (ii) the arithmetic mean of the closing prices per share of such common stock or common equity interests for the 30 consecutive trading days immediately preceding the date of declaration of such dividend.

“*Meo, S.A.*” refers to the former MEO—Serviços de Comunicações e Multimédia, S.A., a public limited liability company (*sociedade anónima*) incorporated under the laws of Portugal with registration number 502 600 268, which was merged into the former PT Comunicações, S.A. on December 29, 2014.

“*Minority Shareholder*” means each of Yedioth Communications Ltd., Fishman Family Properties Ltd., Fishman Family Properties Management (1988) Ltd. and Monitin Itonut Holdings (1985) Ltd.

“*Minority Shareholder Call Option*” means the right to purchase shares of Capital Stock of HOT pursuant to the applicable Minority Shareholder Purchase Agreement.

“*Minority Shareholder Option Exercise*” means the exercise by a Minority Shareholder of the Minority Shareholder Call Option on the terms provided in the applicable Minority Shareholder Purchase Agreement.

“*Minority Shareholder Purchase Agreements*” means each of (a) the Agreement, dated as of November 5, 2012 entered into by and between Yedioth Communications Ltd., a company incorporated in Israel with a registered address of 2 Mozes Street, Tel Aviv, Israel and the Company and (b) the Agreement dated as of November 5, 2012 entered into by and among Fishman Family Properties Ltd. and Fishman Family Properties Management (1988) Ltd., each a company incorporated in Israel with a registered address of 20 Lincoln Street, Tel Aviv, Israel, and Monitin Itonut Holdings (1985) Ltd., a company incorporated in Israel with a registered address of 53 Etzel Street, Rishon Lezion 75706, Israel and the Company, in each case providing for waiver of certain consent rights relating to the Original HOT Transactions and granting of the Minority Shareholder Call Option as consideration therefor, in each case as in effect on December 12, 2012 except for amendments that are not materially adverse to the interests of the Holders of the Notes.

“*Moody’s*” means Moody’s Investors Service, Inc. or any of its successors or assigns that is a Nationally Recognized Statistical Rating Organization.

“*Nationally Recognized Statistical Rating Organization*” shall have the same meaning as used in Section 3(a)(62) of the Exchange Act.

“*Net Available Cash*” from an Asset Disposition means cash payments received (including any cash payments received by way of deferred payment of principal pursuant to a note or installment receivable or otherwise and net proceeds from the sale or other disposition of any securities received as consideration, but only as and when received, but excluding any other consideration received in the form of assumption by the acquiring person of Indebtedness or other obligations relating to the properties or assets that are the subject of such Asset Disposition or received in any other non-cash form) therefrom, in each case net of:

- (1) all legal, accounting, investment banking, title and recording tax expenses, commissions and other fees and expenses Incurred, and all Taxes paid or required to be paid or accrued as a liability under IFRS (after taking into account any available tax credits or deductions and any Tax Sharing Agreements), as a consequence of such Asset Disposition;
- (2) all payments made on any Indebtedness which is secured by any assets subject to such Asset Disposition, in accordance with the terms of any Lien upon such assets, or which must by its terms, or in order to obtain a necessary consent to such Asset Disposition, or by applicable law, be repaid out of the proceeds from such Asset Disposition;
- (3) all distributions and other payments required to be made to minority interest holders (other than any Parent, Altice International or any of their respective Subsidiaries) in Subsidiaries or joint ventures as a result of such Asset Disposition; and
- (4) the deduction of appropriate amounts required to be provided by the seller as a reserve, on the basis of IFRS, against (a) any liabilities associated with the assets disposed in such Asset Disposition and retained by Altice International or any Restricted Subsidiary after such Asset Disposition; or (b) any purchase price adjustment or earn-out in connection with such Asset Disposition.

“*Net Cash Proceeds*”, means, with respect to any issuance or sale of Capital Stock or Subordinated Shareholder Funding, any Incurrence of any Indebtedness or any sale of any asset, the cash proceeds of such issuance or sale net of attorneys’ fees, accountants’ fees, underwriters’ or placement agents’ fees, listing fees, discounts or commissions and brokerage, consultant and other fees and charges actually Incurred in connection with such issuance or sale and net of taxes paid or payable as a result of such issuance or sale (after taking into account any available tax credit or deductions and any tax sharing arrangements).

“*New ASA Notes*” refers to the \$1,480 million aggregate principal amount of Altice S.A.’s 7.625% Senior Notes due 2025 and €750 million aggregate principal amount of Altice S.A.’s 6.250% Senior Notes due 2025, in each case, issued on the Issue Date.

“*New Pari Passu Revolving Credit Facility*” means the € 501 million revolving credit facility agreement, dated on or about December 9, 2014, as amended, restated, supplemented or otherwise modified from time to time, among the Senior Secured Notes Issuer, as borrower, the lenders from time to time party thereto, Citibank International Plc as facility agent and Citibank, N.A., London Branch, as security agent.

“*New Senior Credit Facility*” means the term loan credit agreement dated on or around the Issue Date between the Senior Secured Notes Issuer as borrower and the persons listed in Schedule 2.01 thereto as lenders, Deutsche Bank AG, London Branch as the Administrative Agent and Citibank, N.A., London Branch as Security Agent, as amended.

“*New Senior Secured Notes Indenture*” means the indenture dated as of the Issue Date, as amended, among, inter alios, the Senior Secured Notes Issuer, as issuer, the guarantors party thereto and the trustee and security agent party thereto, governing the New Senior Secured Notes.

“*New Super Senior Revolving Credit Facility*” means the € 330 million revolving credit facility agreement, dated on or about the Issue Date as amended, restated, supplemented or otherwise modified from time to time, among the Senior Secured Notes Issuer, as borrower, the lenders from time to time party thereto, Citibank International plc as facility agent and Citibank, N.A., London Branch, as security agent.

“*New Term Loans*” means the term loans extended to the Issuer pursuant to the New Senior Credit Facility.

“*NIS*” means New Israeli Shekels, the lawful currency of the State of Israel.

“*Notes Documents*” means the Notes (including Additional Notes), the Indenture, the Security Documents, the Notes Escrow Agreement, the Intercreditor Agreement, any Additional Intercreditor Agreements and the Proceeds Loans.

“*Note Guarantee*” means the Guarantee by each Guarantor of the Issuer’s obligations under the Indenture and the Notes, executed pursuant to the provisions of the Indenture.

“*Notes Escrow Agreement*” means the escrow agreement dated as of the Issue Date among, *inter alios*, the Issuer, the Trustee and the Escrow Agent.

“*ODO*” means Altice Hispaniola S.A. (formerly known as Orange Dominicana S.A.), a limited liability corporation (*sociedad anónima*) incorporated under the laws of the Dominican Republic.

“*ONI Group*” refers to Winreason, ONI S.G.P.S., Onitelecom, Knewon, and/or their subsidiaries as the context requires.

“*ONI S.G.P.S.*” means ONI S.G.P.S., S.A., a holding company (*sociedade gestora de participações*) incorporated under the laws of Portugal.

“*Onitelecom*” means Onitelecom—Infocomunicações, S.A., a public limited liability company (*sociedade anónima*) incorporated under the laws of Portugal.

“*Offering Memorandum*” means the offering memorandum in relation to the Notes to be issued on the Issue Date.

“*Officer*” means, with respect to any Person, (1) any member of the Board of Directors, the Chief Executive Officer, the President, the Chief Operating Officer, the Chief Financial Officer, any Vice President, the Treasurer or the Secretary (a) of such Person or (b) if such Person is owned or managed by a single entity, of such entity, or (2) any other individual designated as an “Officer” for the purposes of the Indenture by the Board of Directors of such Person.

“*Officer’s Certificate*” means, with respect to any Person, a certificate signed by one Officer of such Person.

“*OMT Proceeds Loans*” means collectively, the direct and indirect proceeds loans made by Altice Holdings to NewCo OMT and its Subsidiaries in connection with the OMT Invest by Altice International and Altice Caribbean.

“*OMT Proceeds Loans Security Documents*” means the security agreements, pledge agreements, collateral assignments, and any other instrument and document executed and delivered pursuant to the OMT Proceeds Loans or otherwise or any of the foregoing, as the same may be amended, supplemented or otherwise modified from time to time, creating the security interests in the OMT Proceeds Loan Collateral as contemplated by the Indenture and the OMT Proceeds Loan.

“*Operating IRU*” means an indefeasible right of use of, or operating lease or payable for lit or unlit fiber optic cable or telecommunications conduit or the use of either.

“*Opinion of Counsel*” means a written opinion from legal counsel reasonably satisfactory to the Trustee, which opinion may contain customary assumptions and qualifications. The counsel may be an employee of or counsel to any Parent, Altice International or any of their Subsidiaries.

“*Original HOT Transactions*” the transactions consummated on December 27, 2012 pursuant to which Cool acquired all of the remaining shares of HOT and repaid certain indebtedness of Cool and HOT.

“*Original Issuer Notes*” means, collectively, the \$425 million aggregate principal amount of 9⁷/₈% Senior Notes due 2020 issued by the Issuer under the Original Issuer Notes Indenture.

“*Original Issuer Notes Indenture*” means the indenture dated as of December 12, 2012, as amended, among, *inter alios*, the Issuer, as issuer, the guarantors party thereto and the trustee and security agent party thereto, governing the Original Issuer Notes.

“*Original Issuer Notes Issue Date*” means December 12, 2012.

“*Parent*” means any Person of which Altice International at any time is or becomes a Subsidiary and any holding companies established by any Permitted Holder for purposes of holding its investment in any Parent.

“*Parent Expenses*” means:

- (1) costs (including all professional fees and expenses) Incurred by any Parent in connection with reporting obligations under or otherwise Incurred in connection with compliance with applicable laws, rules or regulations of any governmental, regulatory or self-regulatory body or stock exchange, the Indenture or any other agreement or instrument relating to Indebtedness of a Parent, Altice International or any Restricted Subsidiary, including in

respect of any reports filed with respect to the Securities Act, Exchange Act or the respective rules and regulations promulgated thereunder;

- (2) customary indemnification obligations of any Parent owing to directors, officers, employees or other Persons under its charter or by-laws or pursuant to written agreements with any such Person to the extent relating to a Parent, Altice International or their respective Subsidiaries;
- (3) obligations of any Parent in respect of director and officer insurance (including premiums therefor) to the extent relating to a Parent, Altice International or their respective Subsidiaries and reasonable fees and reimbursement of expenses to, and customary indemnities and employee benefit and pension expenses provided on behalf of, directors, officers, consultants or employees of Altice International, any Restricted Subsidiary or any Parent (whether directly or indirectly and including through any Person owned or controlled by any of such directors, officers or employees)
- (4) fees and expenses payable by any Parent in connection with the Original HOT Transaction, July 2013 Transactions, the December 2013 Transactions, and the Transactions;
- (5) general corporate overhead expenses, including (a) professional fees and expenses and other operational expenses of any Parent related to the ownership or operation of the business of Altice International or any of the Restricted Subsidiaries including acquisitions or dispositions by Altice International or a Subsidiary permitted hereunder (whether or not successful), in each case, to the extent such costs, obligations and/or expenses are not paid by another Subsidiary of such or (b) costs and expenses with respect to any litigation or other dispute relating to the Original HOT Transactions, the July 2013 Transactions, the December 2013 Transactions, and the Transactions or the ownership, directly or indirectly, by any Parent;
- (6) any fees and expenses required to maintain any Parent's corporate existence and to provide for other ordinary course operating costs, including customary salary, bonus and other benefits payable to officers and employees of such Parent to reimburse out-of-pocket expenses of the Board of Directors of any Parent and payment of all reasonable out-of-pocket expenses Incurred by any Permitted Holder in connection with its direct or indirect investment in Altice International and its Subsidiaries;
- (7) other fees, expenses and costs relating directly or indirectly to activities of Altice International and its Subsidiaries or any Parent or any other Person established for purposes of or in connection with the Original HOT Transaction, the July 2013 Transactions or the Transactions or which holds directly or indirectly any Capital Stock or Subordinated Shareholder Funding of Altice International, in an amount not to exceed €5 million in any fiscal year;
- (8) any Public Offering Expenses; and
- (9) payments pursuant to any Tax Sharing Agreement in the ordinary course of business or as a result of the formation and maintenance of any consolidated group for tax or accounting purposes in the ordinary course of business.

“*Pari Passu Indebtedness*” means (1) with respect to the Issuer, any Indebtedness that ranks *pari passu* in right of payment to the Notes; and (2) with respect to the Guarantors, any Indebtedness that ranks *pari passu* in right of payment to such Guarantor's Guarantee of the Notes.

“*Paying Agent*” means any Person authorized by the Issuer to pay the principal of (and premium, if any) or interest on any Note on behalf of the Issuer.

“*Permitted Asset Swap*” means the concurrent purchase and sale or exchange of assets used or useful in a Similar Business or a combination of such assets and cash, Cash Equivalents or Temporary Cash Investments between Altice International or any of the Restricted Subsidiaries and another Person; *provided* that any cash or Cash Equivalents received in excess of the value of any cash or Cash Equivalents sold or exchanged must be applied in accordance with the covenant described under “—*Certain Covenants—Limitation on Sales of Assets and Subsidiary Stock*”.

“*Payment Block Event*” means: (1) any Event of Default described in clause (1) or (2) of the first paragraph under the heading “—*Events of Default*” has occurred and is continuing; (2) any Event of Default described in clause (6) or (11) of the first paragraph under the heading “—*Events of Default*” has occurred and is continuing; and (3) any other Event of Default has occurred and is continuing and the Trustee or the Holders of at least 25% in aggregate principal amount of the then outstanding Notes have declared all the Notes to be due and payable immediately (and such acceleration has not been rescinded). No Payment Block Event shall be deemed to have occurred unless the Trustee has delivered notice of the occurrence of such Payment Block Event to the Issuer.

“*Permitted Collateral Liens*” means:

- (1) Liens on the Notes Collateral that are described in one or more of clauses (2), (3), (4), (5), (6), (8), (9), (11), (12), (13), (18), (20), (23), (24) and (28) of the definition of “*Permitted Liens*”;
- (2) Liens on the Notes Collateral (other than any Notes Collateral subject to the Escrow Assignments and the Issuer Share Pledge) to secure (a) Indebtedness that is permitted to be Incurred under the first paragraph of the covenant described under “—*Certain Covenants—Limitation on Indebtedness*”, (b) Indebtedness that is permitted to be Incurred under clauses (1), (2)(a) (in the case of (2)(a), to the extent such Guarantee is in respect of Indebtedness otherwise permitted to be secured on the Notes Collateral and specified in this definition of *Permitted Collateral Liens*), (4)(a), 4(b), (5)(ii), (7)(a) (to the extent relating to Currency Agreements or Interest Rate Agreements related to Indebtedness), (7)(b), (14) (so long as, in the case of the Incurrence of Senior Secured Indebtedness under clause (14), on the date of Incurrence of Indebtedness pursuant to such clause (14) and after giving effect thereto on a *pro forma* basis (including a *pro forma* application of the net proceeds therefrom) as if such Indebtedness had been Incurred at the beginning of the relevant period, the Consolidated Net Senior Secured Leverage Ratio is no greater than 3.0 to 1.0 and, in the case of Incurrence of Indebtedness that is not Senior Secured Indebtedness under clause (14), only if on the date of Incurrence of such Indebtedness and after giving effect thereto on a *pro forma* basis (including a *pro forma* application of the net proceeds therefrom) as if such Indebtedness had been Incurred at the beginning of the relevant period, the Consolidated Net Leverage Ratio is no greater than 4.0 to 1.0) and clause (15) under the second paragraph of the covenant described under “—*Certain Covenants—Limitation on Indebtedness*” and (c) any Refinancing Indebtedness in respect of Indebtedness referred to in the foregoing clause (a) or (b), *provided, however*, that (i) such Lien shall rank (x) equal to all other Liens on such Notes Collateral securing Senior Indebtedness of the Issuer and the Guarantors, if such Indebtedness is Senior Indebtedness of the Issuer or the Guarantors (as applicable), or (y) *pari passu* with or junior to the Liens securing the Notes and the Note Guarantees (including by virtue of the Intercreditor Agreement or an Additional Intercreditor Agreement); and (ii) each of the parties thereto will have entered into the Intercreditor Agreement or an Additional Intercreditor Agreement; and
- (3) Liens on the Issuer Share Pledge to secure *Pari Passu* Indebtedness of the Issuer that is permitted to be Incurred under covenant described under “—*Certain Covenants—Limitation on Indebtedness*” (other than clauses (3), (4)(a), (5), (7), (9), (10), (11), (12) and (13) of the second paragraph thereof); *provided, however*, that (i) such Lien shall rank *pari passu* or junior to the Liens securing the Notes; (ii) in each case, all property and assets of the Issuer securing such Indebtedness also secure the Notes on a senior or *pari passu* basis; and (iii) each of the parties thereto will have entered into the Intercreditor Agreement or an Additional Intercreditor Agreement.

“*Permitted Holders*” means, collectively, (1) the Investor, (2) Investor Affiliates and (3) any Person who is acting as an underwriter in connection with a public or private offering of Capital Stock of any Parent or Altice International, acting in such capacity. Any person or group whose acquisition of beneficial ownership constitutes a Change of Control in respect of which a Change of Control Offer is made in accordance with the requirements of the Indenture will thereafter, together with its Affiliates, constitute an additional *Permitted Holder*.

“*Permitted Investment*” means (in each case, by Altice International or any of the Restricted Subsidiaries and subject to the covenant described under the heading “—*Certain Covenants—Limitation on Issuer and Senior Secured Notes Issuer Activities*”):

- (1) Investments in (a) a Restricted Subsidiary (including the Capital Stock of a Restricted Subsidiary), Altice International (other than any Investment in a Minority Shareholder Call Option or Minority Shareholder Purchase Agreement) or (b) any Person (including the Capital Stock of any such Person) that is engaged in any Similar Business and such Person will, upon the making of such Investment, become a Restricted Subsidiary;
- (2) Investments in another Person if such Person is engaged in any Similar Business and as a result of such Investment such other Person is merged, consolidated or otherwise combined with or into, or transfers or conveys all or substantially all its assets to, Altice International or a Restricted Subsidiary;
- (3) Investments in cash, Cash Equivalents, Temporary Cash Investments or Investment Grade Securities;
- (4) Investments in receivables owing to Altice International or any Restricted Subsidiary created or acquired in the ordinary course of business and payable or dischargeable in accordance with customary trade terms; *provided, however*, that such trade terms may include such concessionary trade terms as Altice International or any such Restricted Subsidiary deems reasonable under the circumstances;

- (5) Investments in payroll, travel and similar advances to cover matters that are expected at the time of such advances ultimately to be treated as expenses for accounting purposes and that are made in the ordinary course of business;
- (6) Management Advances;
- (7) Investments in Capital Stock, obligations or securities received in settlement of debts created in the ordinary course of business and owing to Altice International or any Restricted Subsidiary (including obligations of trade creditors and customers), or as a result of foreclosure, perfection or enforcement of any Lien, or in satisfaction of judgments or pursuant to any plan of reorganization or similar arrangement including upon the bankruptcy or insolvency of a debtor or in compromise or resolution of any litigation, arbitration or other dispute;
- (8) Investments made as a result of the receipt of non-cash consideration from a sale or other disposition of property or assets, including an Asset Disposition, in each case, that was made in compliance with “—*Certain Covenants—Limitation on Sales of Assets and Subsidiary Stock*” and other Investments resulting from the disposition of assets in transactions excluded from the definition of “Asset Disposition” pursuant to the exclusions from such definition;
- (9) Investments in existence on, or made pursuant to legally binding commitments in existence on, the Issue Date and any modification, replacement, renewal or extension thereof; *provided* that the amount of any such Investment may not be increased except (a) as required by the terms of such Investment as in existing on the Issue Date or (b) as otherwise permitted by the Indenture;
- (10) Currency Agreements, Interest Rate Agreements, Commodity Hedging Agreements and related Hedging Obligations, which transactions or obligations are Incurred pursuant to clause (7) of the second paragraph of the covenant described under “—*Certain Covenants—Limitation on Indebtedness*”;
- (11) pledges or deposits with respect to leases or utilities provided to third parties in the ordinary course of business or Liens otherwise described in the definition of “Permitted Liens” or made in connection with Liens permitted under the covenant described under “—*Certain Covenants—Limitation on Liens*”;
- (12) any Investment to the extent made using Capital Stock of Altice International (other than Disqualified Stock or Designated Preference Shares), Subordinated Shareholder Funding or Capital Stock of any Parent as consideration;
- (13) any transaction to the extent constituting an Investment that is permitted and made in accordance with the provisions of the second paragraph of the covenant described under “—*Certain Covenants—Limitation on Affiliate Transactions*” (except those described in clauses (1), (3), (6), (8), (9) and (12) of that paragraph);
- (14) Guarantees not prohibited by the covenant described under “—*Certain Covenants—Limitation on Indebtedness*” and (other than with respect to Indebtedness) guarantees, keepwells and similar arrangements in the ordinary course of business;
- (15) Investments in the Notes, the Existing Senior Notes, any Additional Notes, the Existing Senior Secured Notes, the New Senior Secured Notes and loans under the Senior Credit Facilities;
- (16) (a) Investments acquired after the Issue Date as a result of the acquisition by Altice International or any Restricted Subsidiary of another Person, including by way of a merger, amalgamation or consolidation with or into Altice International or any of its Restricted Subsidiaries in a transaction that is not prohibited by the covenant described under “—*Certain Covenants—Merger and Consolidation*” to the extent that such Investments were not made in contemplation of such acquisition, merger, amalgamation or consolidation and (b) Investments of a Restricted Subsidiary existing on the date such Person becomes a Restricted Subsidiary to the extent that such Investments were not made in contemplation of such Person becoming a Restricted Subsidiary;
- (17) Investments, taken together with all other Investments made pursuant to this clause (17) and at any time outstanding, in an aggregate amount at the time of such Investment not to exceed the greater of 3% of Total Assets and €375 million plus the amount of any distributions, dividends, payments or other returns in respect of such Investments (without duplication for purposes of the covenant described in the section “—*Certain Covenants—Limitation on Restricted Payments*”); *provided*, that, if an Investment is made pursuant to this clause in a Person that is not a Restricted Subsidiary and such Person subsequently becomes a Restricted Subsidiary, such Investment shall thereafter be deemed to have been made pursuant to clause (1) or (2) of the definition of “Permitted Investments” and not this clause;

- (18) Investments in joint ventures and similar entities and Unrestricted Subsidiaries having an aggregate fair market value, when taken together with all other Investments made pursuant to this clause that are at the time outstanding, not to exceed the greater of €375 million and 3.0% of Total Assets at the time of such Investment (with the fair market value of each Investment being measured at the time made and without giving effect to subsequent changes in value); and
- (19) prior to the Completion Date, Investments of all or a portion of the Escrowed Proceeds permitted under the Notes Escrow Agreement.

“*Permitted Issuer Investments*” means Investments in:

- (1) cash, Cash Equivalents, Temporary Cash Investments and Investment Grade Securities;
- (2) the Notes and the Existing Senior Notes;
- (3) any other Indebtedness of the Issuer permitted to be Incurred under the Indenture;
- (4) any Proceeds Loan; and
- (5) prior to the Completion Date, Investments of all or a portion of the Escrowed Proceeds permitted under the Notes Escrow Agreement.

“*Permitted Issuer Liens*” means:

- (1) Permitted Collateral Liens; and
- (2) Liens described in one or more of clauses (4), (5), (9), (11), (12), (13), (22), (27) (only in respect of Liens on cash, Cash Equivalents or other property arising in connection with the defeasance, discharge or redemption of Indebtedness) and (28) of the definition of Permitted Liens.

“*Permitted Liens*” means, with respect to any Person:

- (1) Liens on assets or property of a Restricted Subsidiary that is not a Guarantor securing Indebtedness of such Restricted Subsidiary or another Restricted Subsidiary that is not a Guarantor;
- (2) pledges, deposits or Liens under workmen’s compensation laws, unemployment insurance laws, social security laws or similar legislation, or insurance related obligations (including pledges or deposits securing liability to insurance carriers under insurance or self-insurance arrangements and including Liens on insurance policies and proceeds thereof, or other deposits, to secure insurance premium financings), or in connection with bids, tenders, completion guarantees, contracts (other than for borrowed money) or leases, or to secure utilities, licenses, public or statutory obligations, or to secure surety, indemnity, judgment, appeal or performance bonds, guarantees of government contracts (or other similar bonds, instruments or obligations), or as security for contested taxes or import or customs duties or for the payment of rent, or other obligations of like nature, in each case Incurred in the ordinary course of business;
- (3) Liens imposed by law, including carriers’, warehousemen’s, mechanics’, landlords’, materialmen’s and repairmen’s or other like Liens, in each case for sums not yet overdue for a period of more than 60 days or that are bonded or being contested in good faith by appropriate proceedings;
- (4) Liens for taxes, assessments or other governmental charges not yet subject to penalties for non-payment or which are being contested in good faith by appropriate proceedings; *provided* that appropriate reserves required pursuant to IFRS have been made in respect thereof;
- (5) (a) Liens in favor of issuers of surety, performance or other bonds, guarantees or letters of credit or bankers’ acceptances (not issued to support Indebtedness for borrowed money) issued pursuant to the request of and for the account of Altice International or any Restricted Subsidiary in the ordinary course of its business and (b) Liens in connection with cash management programs established in the ordinary course of business;
- (6) encumbrances, ground leases, easements (including reciprocal easement agreements), survey exceptions, or reservations of, or rights of others for, licenses, rights of way, sewers, electric lines, telegraph and telephone lines and other similar purposes, or zoning, building codes or other restrictions (including minor defects or irregularities in title and similar encumbrances) as to the use of real properties or Liens incidental to the conduct

of the business of Altice International and the Restricted Subsidiaries or to the ownership of its properties which do not in the aggregate materially adversely affect the value of said properties or materially impair their use in the operation of the business of Altice International and the Restricted Subsidiaries;

- (7) Liens on assets or property of Altice International or any Restricted Subsidiary securing Hedging Obligations permitted under the Indenture;
- (8) leases, licenses, subleases and sublicenses of assets (including real property and intellectual property rights), in each case entered into in the ordinary course of business;
- (9) Liens arising out of judgments, decrees, orders or awards not giving rise to an Event of Default and notices of *lis pendens* and associated rights so long as any appropriate legal proceedings which may have been duly initiated for the review of such judgment, decree, order, award or notice have not been finally terminated or the period within which such proceedings may be initiated has not expired;
- (10) Liens on assets or property of Altice International or any Restricted Subsidiary (including Capital Stock) for the purpose of securing Capitalized Lease Obligations or Purchase Money Obligations, or securing the payment of all or a part of the purchase price of, or securing other Indebtedness Incurred to finance or refinance the acquisition, improvement or construction of, assets or property acquired or constructed in the ordinary course of business; *provided* that (a) the aggregate principal amount of Indebtedness secured by such Liens is otherwise permitted to be Incurred under the Indenture (excluding Indebtedness Incurred pursuant to the first paragraph of the covenant described under “*Certain Covenants—Limitation on Indebtedness*”) and (b) any such Lien may not extend to any assets or property of Altice International or any Restricted Subsidiary other than assets or property acquired, improved, constructed or leased with the proceeds of such Indebtedness and any improvements or accessions to such assets and property;
- (11) Liens arising by virtue of any statutory or common law provisions relating to banker’s Liens, rights of set-off or similar rights and remedies as to deposit accounts or other funds maintained with a depository or financial institution;
- (12) Liens arising from Uniform Commercial Code financing statement filings (or similar filings in other applicable jurisdictions) regarding operating leases entered into by Altice International and the Restricted Subsidiaries in the ordinary course of business;
- (13) (a) with respect to Altice International and its Restricted Subsidiaries (other than HOT and its Subsidiaries and NewCo OMT and its Subsidiaries), Liens existing on or provided for or required to be granted under written agreements existing on the Issue Date after giving effect to the Transactions, including the Issuance of the Notes and the application of the proceeds thereof (including after such proceeds are released from the Escrow Account); (b) with respect to HOT and its Subsidiaries, Liens existing on, or provided for or required to be granted under written agreements existing on, December 12, 2012 after giving effect to the Original HOT Transactions, including, for avoidance of doubt, the second lien floating charge to secure certain payment obligations of HOT to the State of Israel pursuant to a royalty agreement as in effect on December 12, 2012; and (c) with respect to NewCo OMT and its Subsidiaries, Liens existing on, or provided for or required to be granted under written agreements existing on July 5, 2013 after giving effect to the July 2013 Transactions;
- (14) Liens on property, other assets or shares of stock of a Person at the time such Person becomes a Restricted Subsidiary (or at the time Altice International or a Restricted Subsidiary acquires such property, other assets or shares of stock, including any acquisition by means of a merger, consolidation or other business combination transaction with or into Altice International or any Restricted Subsidiary); *provided, however*, that such Liens are not created, Incurred or assumed in anticipation of or in connection with such other Person becoming a Restricted Subsidiary (or such acquisition of such property, other assets or stock); *provided, further*, that such Liens are limited to all or part of the same property, other assets or stock (plus improvements, accession, proceeds or dividends or distributions in connection with the original property, other assets or stock) that secured (or, under the written arrangements under which such Liens arose, could secure) the obligations to which such Liens relate;
- (15) Liens on assets or property of Altice International or any Restricted Subsidiary securing Indebtedness or other obligations of Altice International or such Restricted Subsidiary owing to Altice International or another Restricted Subsidiary, or Liens in favor of Altice International or any Restricted Subsidiary;
- (16) Liens securing Refinancing Indebtedness Incurred to refinance Indebtedness that was previously so secured, and permitted to be secured under the Indenture; *provided* that any such Lien is limited to all or part of the same property or assets (plus improvements, accessions, proceeds or dividends or distributions in respect thereof) that

secured (or, under the written arrangements under which the original Lien arose, could secure) the Indebtedness being refinanced or is in respect of property that is or could be the security for or subject to a Permitted Lien hereunder;

- (17) any interest or title of a lessor under any Capitalized Lease Obligation or operating lease;
- (18) (a) mortgages, liens, security interest, restrictions, encumbrances or any other matters of record that have been placed by any government, statutory or regulatory authority, developer, landlord or other third party on property over which Altice International or any Restricted Subsidiary has easement rights or on any leased property and subordination or similar arrangements relating thereto and (b) any condemnation or eminent domain proceedings affecting any real property;
- (19) any encumbrance or restriction (including put and call arrangements) with respect to Capital Stock of, or assets owned by, any joint venture or similar arrangement pursuant to any joint venture or similar agreement;
- (20) Liens on property or assets under construction (and related rights) in favor of a contractor or developer or arising from progress or partial payments by a third party relating to such property or assets;
- (21) Liens on Receivables Assets Incurred in connection with a Qualified Receivables Financing;
- (22) Liens on Escrowed Proceeds for the benefit of the related holders of debt securities or other Indebtedness (or the underwriters or arrangers thereof) or on cash set aside at the time of the Incurrence of any Indebtedness or government securities purchased with such cash, in either case to the extent such cash or government securities prefund the payment of interest on such Indebtedness and are held in an escrow account or similar arrangement to be applied for such purpose;
- (23) bankers' Liens, Liens on specific items of inventory or other goods (and the proceeds thereof) of any Person securing such Person's obligations in respect of bankers' acceptances issued or created in the ordinary course of business of such Person to facilitate the purchase, shipment or storage of such inventory or other goods and Liens securing or arising by reason of any netting or set-off arrangement entered into in the ordinary course of banking or other trading activities;
- (24) Liens arising out of conditional sale, title retention, hire purchase, consignment or similar arrangements for the sale of goods entered into in the ordinary course of business, and pledges of goods, the related documents of title and/or other related documents arising or created in the ordinary course of business or operations as Liens only for Indebtedness to a bank or financial institution directly relating to the goods or documents on or over which the pledge exists;
- (25) Permitted Collateral Liens;
- (26) Liens on Capital Stock or other securities or assets of any Unrestricted Subsidiary that secure Indebtedness of such Unrestricted Subsidiary;
- (27) any security granted over Cash Equivalents in connection with the disposal thereof to a third party and Liens on cash, Cash Equivalents or other property arising in connection with the defeasance, discharge or redemption of Indebtedness;
- (28) (a) Liens created for the benefit of or to secure, directly or indirectly, the Notes, (b) Liens pursuant to the Intercreditor Agreement and (c) Liens in respect of property and assets securing Indebtedness if the recovery in respect of such Liens is subject to loss-sharing or similar provisions as among the Holders of the Notes and the creditors of such Indebtedness pursuant to the Intercreditor Agreement or an Additional Intercreditor Agreement;
- (29) Liens created on any asset of Altice International or a Restricted Subsidiary established to hold assets of any stock option plan or any other management or employee benefit or incentive plan or unit trust of Altice International or a Restricted Subsidiary securing any loan to finance the acquisition of such assets;
- (30) subject to the covenant described under the heading "*Certain Covenants—Limitation on Issuer and Senior Secured Notes Issuer Activities*", Liens on the property and assets of Altice International and the Restricted Subsidiaries to secure (a) Indebtedness that is permitted to be Incurred under the clause (1) of the first paragraph of the covenant described under "*Certain Covenants—Limitation on Indebtedness*", (b) Indebtedness that is permitted to be Incurred under clauses (1), (2)(a) (in the case of (2)(a), to the extent such Guarantee is in respect

of Indebtedness otherwise specified in this clause (30)), (4)(b), (5), (7)(a) (to the extent relating to Currency Agreements or Interest Rate Agreements related to Indebtedness), (7)(b), (14) (so long as, in the case of clause (14), on the date of Incurrence of Indebtedness pursuant to such clause (14) and after giving effect thereto on a pro forma basis, the Senior Secured Notes Issuer could have incurred €1.00 of Indebtedness pursuant to clause (1) the first paragraph of the covenant described under “—Certain Covenants—Limitation on Indebtedness”) and clause (15) under the second paragraph of the covenant described under “—*Certain Covenants—Limitation on Indebtedness*” and (c) any Refinancing Indebtedness in respect of Indebtedness referred to in the foregoing clause (a) or (b), *provided, however*, that such Indebtedness (other than Indebtedness Incurred under clauses (1), (5) and (15) under the second paragraph of the covenant described under “—*Certain Covenants—Limitation on Indebtedness*”) is Senior Indebtedness of the Guarantors; and

- (31) Liens; *provided* that the maximum amount of Indebtedness secured in the aggregate at any one time pursuant to this clause (31) does not exceed the greater of €125 million and 1% of Total Assets.

“*Permitted Senior Secured Notes Issuer Investments*” means Investments in:

- (1) cash and Cash Equivalents;
- (2) the Senior Secured Notes and loans under the Senior Credit Facilities;
- (3) any other Indebtedness of the Senior Secured Notes Issuer permitted to be Incurred under the Indenture; and
- (4) any Finco Proceeds Loan.

“*Permitted Senior Secured Notes Issuer Liens*” means:

- (1) Permitted Collateral Liens; and
- (2) Liens described in one or more of clauses (4), (5), (9), (11), (12), (13), (22), (27) (only in respect of Liens on cash, Cash Equivalents or other property arising in connection with the defeasance, discharge or redemption of Indebtedness), (28) of the definition of Permitted Liens and (30).

“*Person*” means any individual, corporation, partnership, joint venture, association, joint-stock company, trust, unincorporated organization, limited liability company, government or any agency or political subdivision thereof or any other entity.

“*Preferred Stock*”, as applied to the Capital Stock of any Person, means Capital Stock of any class or classes (however designated) which is preferred as to the payment of dividends or as to the distribution of assets upon any voluntary or involuntary liquidation or dissolution of such Person, over shares of Capital Stock of any other class of such Person.

“*Pro forma EBITDA*” means, for any period, the Consolidated EBITDA of Altice International and the Restricted Subsidiaries, *provided* that for the purposes of calculating Pro forma EBITDA for such period, if, as of such date of determination:

- (1) since the beginning of such period Altice International or any Restricted Subsidiary has disposed of any company, any business, or any group of assets constituting an operating unit of a business or otherwise ceases to be a Restricted Subsidiary (and is not a Restricted Subsidiary at the end of such period) (any such disposition, a “*Sale*”) or if the transaction giving rise to the need to calculate the Consolidated Net Leverage Ratio or Consolidated Net Senior Secured Leverage Ratio is such a Sale, Pro forma EBITDA for such period will be reduced by an amount equal to the Consolidated EBITDA (if positive) attributable to the assets which are the subject of such Sale for such period or increased by an amount equal to the Consolidated EBITDA (if negative) attributable thereto for such period; *provided* that if any such sale constitutes “discontinued operations” in accordance with IFRS, Consolidated Net Income shall be reduced by an amount equal to the Consolidated Net Income (if positive) attributable to such operations for such period or increased by an amount equal to the Consolidated Net Income (if negative) attributable thereto for such period;
- (2) since the beginning of such period, a Parent, Altice International or any Restricted Subsidiary (by merger or otherwise) has made an Investment in any Person that thereby becomes a Restricted Subsidiary, or otherwise has acquired any company, any business, or any group of assets constituting an operating unit of a business or a Person otherwise becomes a Restricted Subsidiary (and remains a Restricted Subsidiary at the end of such period) (any such Investment, acquisition or designation, a “*Purchase*”), including any such Purchase occurring in connection with a transaction causing a calculation to be made hereunder, Pro forma EBITDA for such period

will be calculated after giving *pro forma* effect thereto as if such Purchase occurred on the first day of such period; and

- (3) since the beginning of such period, any Person (that became a Restricted Subsidiary or was merged or otherwise combined with or into Altice International or any Restricted Subsidiary since the beginning of such period) will have made any Sale or any Purchase that would have required an adjustment pursuant to clause (1) or (2) above if made by Altice International or a Restricted Subsidiary since the beginning of such period, Pro forma EBITDA for such period will be calculated after giving *pro forma* effect thereto as if such Sale or Purchase occurred on the first day of such period.

For the purposes of this definition and the definitions of Consolidated EBITDA, Consolidated Income Taxes, Consolidated Interest Expense, Consolidated Net Income, Consolidated Net Senior Secured Leverage Ratio and Consolidated Net Leverage Ratio (a) whenever *pro forma* effect is to be given to any transaction (including, without limitation, transactions listed in clauses (1)-(3) hereof) or calculation hereunder or such other definitions, the pro forma calculations will be as determined in good faith by a responsible financial or accounting officer of Altice International or an Officer of the Issuer (including in respect of anticipated expense and cost reductions and synergies (other than revenue synergies)) (calculated on a *pro forma* basis as though such expense and cost reductions and synergies had been realized on the first day of the period for which Pro forma EBITDA is being determined and as though such cost savings, operating expense reductions and synergies were realized during the entirety of such period), (b) in determining the amount of Indebtedness outstanding on any date of determination, *pro forma* effect shall be given to any Incurrence, repayment, repurchase, defeasance or other acquisition, retirement or discharge of Indebtedness as if such transaction had occurred on the first day of the relevant period and (c) if any Indebtedness bears a floating rate of interest and is being given *pro forma* effect, the interest on such Indebtedness shall be calculated as if the rate in effect on the date of determination had been the applicable rate for the entire period (taking into account any Hedging Obligations applicable to such Indebtedness if such Hedging Obligation has a remaining term in excess of 12 months).

“*Proceeds Loan*” means any loan agreement entered into between the Issuer and the Senior Secured Notes Issuer pursuant to which the Issuer lends to the Senior Secured Notes Issuer all or substantially all of the net proceeds of any Incurrence of Indebtedness by the Issuer; *provided* that (i) the principal amount of, and interest rate on, such Proceeds Loan will not be less than the principal amount of, and interest rate on, the Indebtedness of the Issuer that funded such Proceeds Loan, (ii) a Lien over such Proceeds Loan is granted at the time of its Incurrence on a junior basis to secure the Notes and the Note Guarantees and (iii) such Proceeds Loan shall be subject to the Intercreditor Agreement and any Additional Intercreditor Agreement.

“*PT OpCo*” refers to MEO—Serviços de Comunicações e Multimédia, S.A., a public limited liability company (*sociedade anónima*) incorporated under the laws of Portugal with registration number 504 615 947, which was formerly known as PT Comunicações, S.A. and is the surviving entity from the merger of Meo, S.A. into PT Comunicações, S.A. on December 29, 2014.

“*Public Debt*” means any Indebtedness consisting of bonds, debentures, notes or other similar debt securities issued in (1) a public offering registered under the Securities Act or (2) a private placement to institutional investors that is underwritten for resale in accordance with Rule 144A or Regulation S under the Securities Act, whether or not it includes registration rights entitling the holders of such debt securities to registration thereof with the SEC for public resale.

“*Public Offering*” means any offering, including an Initial Public Offering, of shares of common stock or other common equity interests that are listed on an exchange or publicly offered (which shall include an offering pursuant to Rule 144A and/or Regulation S under the Securities Act to professional market investors or similar persons).

“*Public Offering Expenses*” means expenses Incurred by any Parent in connection with any Public Offering or any offering of Public Debt (whether or not successful):

- (1) where the net proceeds of such offering are intended to be received by or contributed or loaned to Altice International or a Restricted Subsidiary;
- (2) in a pro-rated amount of such expenses in proportion to the amount of such net proceeds intended to be so received, contributed or loaned; or
- (3) otherwise on an interim basis prior to completion of such offering so long as any Parent shall cause the amount of such expenses to be repaid to Altice International or the relevant Restricted Subsidiary out of the proceeds of such offering promptly if completed, in each case, to the extent such expenses are not paid by another Subsidiary of such Parent.

“*Purchase Money Obligations*” means any Indebtedness Incurred to finance or refinance the acquisition, leasing, construction or improvement of property (real or personal) or assets (including Capital Stock), and whether acquired through the direct acquisition of such property or assets or the acquisition of the Capital Stock of any Person owning such property or assets, or otherwise.

“*Qualified Receivables Financing*” means any Receivables Financing of a Receivables Subsidiary that meets the following conditions: (1) an Officer or the Board of Directors of Altice International shall have determined in good faith that such Qualified Receivables Financing (including financing terms, covenants, termination events and other provisions) is in the aggregate economically fair and reasonable to Altice International and the Receivables Subsidiary, (2) all sales of accounts receivable and related assets to the Receivables Subsidiary are made at fair market value (as determined in good faith by Altice International), and (3) the financing terms, covenants, termination events and other provisions thereof shall be on market terms (as determined in good faith by Altice International) and may include Standard Securitization Undertakings.

The grant of a security interest in any accounts receivable of Altice International or any Restricted Subsidiary (other than a Receivables Subsidiary) to secure Indebtedness under a Credit Facility or Indebtedness in respect of the Notes shall not be deemed a Qualified Receivables Financing.

“*Rating Agencies*” means Moody’s and S&P or, in the event Moody’s or S&P no longer assigns a rating to the Notes, any other Nationally Recognized Statistical Rating Organization who assigns a rating to the Notes in lieu of the ratings by Moody’s or S&P.

“*Rating Date*” means the date which is 90 days prior to the earlier of (1) a Change of Control; and (2) public notice of the occurrence of a Change of Control or of the intention of the Issuer to effect a Change of Control.

“*Rating Decline*” means the decrease in the rating of the Notes of a series by at least one of the Rating Agencies by one or more gradations (including gradations within rating categories as well as between rating categories) from its rating on the Rating Date or the withdrawal of a rating of the Notes of such series by any of the Rating Agencies on, or within 60 days after, the earlier of the date of public notice of the occurrence of a Change of Control or of the intention of the Issuer to effect a Change of Control or the occurrence of a Change of Control (which period shall be extended so long as the rating of the Notes of such series is under publicly announced consideration by any of the Rating Agencies).

If no Rating Agency announces an action with regard to its rating of the Notes of a series after the occurrence of a Change of Control, the Issuer shall request each Rating Agency to confirm its rating of the Notes of such series before the end of such 60-day period.

“*Receivable*” means a right to receive payment arising from a sale or lease of goods or services by a Person pursuant to an arrangement with another Person pursuant to which such other Person is obligated to pay for goods or services under terms that permit the purchase of such goods and services on credit, as determined on the basis of IFRS.

“*Receivables Assets*” means any assets that are or will be the subject of a Qualified Receivables Financing.

“*Receivables Fees*” means distributions or payments made directly or by means of discounts with respect to any participation interest issued or sold in connection with, and other fees paid to a Person that is not a Restricted Subsidiary in connection with, any Receivables Financing.

“*Receivables Financing*” means any transaction or series of transactions that may be entered into by Altice International or any of its Subsidiaries pursuant to which Altice International or any of its Subsidiaries may sell, convey or otherwise transfer to (a) a Receivables Subsidiary (in the case of a transfer by Altice International or any of its Subsidiaries), or (b) any other Person (in the case of a transfer by a Receivables Subsidiary), or may grant a security interest in, any accounts receivable (whether now existing or arising in the future) of Altice International or any of its Subsidiaries, and any assets related thereto, including all collateral securing such accounts receivable, all contracts and all guarantees or other obligations in respect of such accounts receivable, proceeds of such accounts receivable and other assets which are customarily transferred or in respect of which security interest are customarily granted in connection with asset securitization transactions involving accounts receivable and any Hedging Obligations entered into by Altice International or any such Subsidiary in connection with such accounts receivable.

“*Receivables Repurchase Obligation*” means any obligation of a seller of receivables in a Qualified Receivables Financing to repurchase receivables arising as a result of a breach of a representation, warranty or covenant or otherwise, including as a result of a receivable or portion thereof becoming subject to any asserted defense, dispute, off-set or counterclaim of any kind as a result of any action taken by, any failure to take action by or any other event relating to the seller.

“*Receivables Subsidiary*” means a Wholly Owned Subsidiary of Altice International (or another Person formed for the purposes of engaging in a Qualified Receivables Financing with Altice International in which Altice International or any Subsidiary of Altice International (other than the Issuer and the Senior Secured Notes Issuer) makes an Investment and to which Altice International or any Subsidiary of Altice International transfers accounts receivable and related assets) which engages in no activities other than in connection with the financing of accounts receivable of Altice International and its Subsidiaries, all proceeds thereof and all rights (contractual or other), collateral and other assets relating thereto, and any business or activities incidental or related to such business, and which is designated by the Board of Directors of Altice International (as provided below) as a Receivables Subsidiary and:

- (1) no portion of the Indebtedness or any other obligations (contingent or otherwise) of which (i) is guaranteed by Altice International or any other Restricted Subsidiary (excluding guarantees of obligations (other than the principal of, and interest on, Indebtedness) pursuant to Standard Securitization Undertakings), (ii) is subject to terms that are substantially equivalent in effect to a guarantee of any losses on securitized or sold receivables by Altice International or any other Restricted Subsidiary, (iii) is recourse to or obligates Altice International or any other Restricted Subsidiary in any way other than pursuant to Standard Securitization Undertakings, or (iv) subjects any property or asset of Altice International or any Restricted Subsidiary, directly or indirectly, contingently or otherwise, to the satisfaction thereof, other than pursuant to Standard Securitization Undertakings;
- (2) with which neither Altice International nor any other Restricted Subsidiary has any material contract, agreement, arrangement or understanding other than on terms which Altice International reasonably believes to be no less favorable to Altice International or such Restricted Subsidiary than those that might be obtained at the time from Persons that are not Affiliates of Altice International; and
- (3) to which neither Altice International nor any other Restricted Subsidiary has any obligation to maintain or preserve such entity’s financial condition or cause such entity to achieve certain levels of operating results.

Any such designation by the Board of Directors of Altice International shall be evidenced to the Trustee by filing with the Trustee a copy of the resolution of the Board of Directors of Altice International giving effect to such designation and an Officer’s Certificate certifying that such designation complied with the foregoing conditions.

“*Refinance*” means refinance, refund, replace, renew, repay, modify, restate, defer, substitute, supplement, reissue, resell, extend or increase (including pursuant to any defeasance or discharge mechanism) and the terms “*refinances*”, “*refinanced*” and “*refinancing*” as used for any purpose in the Indenture shall have a correlative meaning.

“*Refinancing Indebtedness*” means Indebtedness of Altice International or any Restricted Subsidiary to refund, refinance, replace, exchange, renew, repay or extend (including pursuant to any defeasance or discharge mechanism) any Indebtedness existing on the date of the Indenture or Incurred in compliance with the Indenture including Indebtedness that refinances Refinancing Indebtedness; *provided, however*, that:

- (1) if the Indebtedness being refinanced constitutes Subordinated Indebtedness, the Refinancing Indebtedness has a final stated maturity at the time such Refinancing Indebtedness is Incurred that is the same as or later than the final stated maturity of the Indebtedness being refinanced or, if shorter, the Notes;
- (2) such Refinancing Indebtedness is Incurred in an aggregate principal amount (or if issued with original issue discount, an aggregate issue price) that is equal to or less than the sum of the aggregate principal amount (or if issued with original issue discount, the aggregate accreted value) then outstanding of the Indebtedness being refinanced (plus, without duplication, any additional Indebtedness Incurred to pay interest or premiums required by the instruments governing such existing Indebtedness and costs, expenses and fees Incurred in connection therewith);
- (3) if the Indebtedness being refinanced is expressly subordinated to the Notes or any Note Guarantee, such Refinancing Indebtedness is subordinated to the Notes or such Note Guarantee, as applicable, on terms at least as favorable to the Holders as those contained in, the documentation governing the Indebtedness being refinanced; and
- (4) if the Issuer or any Guarantor was the obligor on the Indebtedness being refinanced, such Indebtedness is incurred either by the Issuer or by a Guarantor,

provided, however, that Refinancing Indebtedness shall not include (i) Indebtedness of the Issuer or the Senior Secured Notes Issuer that refinances Indebtedness of an Unrestricted Subsidiary, (ii) Indebtedness of the Issuer owing to and held by Altice International or any Restricted Subsidiary, Indebtedness of Altice International owing to and held by the Issuer,

Altice International or any Restricted Subsidiary or Indebtedness of a Restricted Subsidiary owing to and held by Altice International or any other Restricted Subsidiary or (iii) any Finco Proceeds Loan or any Proceeds Loan.

Refinancing Indebtedness in respect of any Credit Facility or any other Indebtedness may be Incurred from time to time after the termination, discharge, or repayment of any such Credit Facility or other Indebtedness.

“*Related Taxes*” means, without duplication (including, for the avoidance of doubt, without duplication of any amounts paid pursuant to any Tax Sharing Agreement):

- (1) any Taxes, including sales, use, transfer, rental, ad valorem, value added, stamp, property, consumption, franchise, license, capital, registration, business, customs, net worth, gross receipts, excise, occupancy, intangibles or similar Taxes (other than (x) Taxes measured by income and (y) withholding taxes), required to be paid (*provided* such Taxes are in fact paid) by any Parent by virtue of its:
 - (a) being incorporated or otherwise being established or having Capital Stock outstanding (but not by virtue of owning stock or other equity interests of any corporation or other entity other than, directly or indirectly, Altice International or any Subsidiary of Altice International);
 - (b) issuing or holding Subordinated Shareholder Funding;
 - (c) being a holding company parent, directly or indirectly, of Altice International or any Subsidiary of Altice International;
 - (d) receiving dividends from or other distributions in respect of the Capital Stock of, directly or indirectly, Altice International or any Subsidiary of Altice International; or
 - (e) having made any payment in respect to any of the items for which Altice International is permitted to make payments to any Parent pursuant to “—*Certain Covenants—Limitation on Restricted Payments*”; or
- (2) if and for so long as the Issuer or Altice International is a member of a group filing a consolidated or combined tax return with any Parent, any Taxes measured by income for which such Parent is liable up to an amount not to exceed with respect to such Taxes the amount of any such Taxes that Altice International and Subsidiaries of Altice International would have been required to pay on a separate company basis or on a consolidated basis if Altice International and the Subsidiaries of Altice International had paid tax on a consolidated, combined, group, affiliated or unitary basis on behalf of an affiliated group consisting only of Altice International and the Subsidiaries of Altice International.

“*Representative*” means any trustee, agent or representative (if any) for an issue of Indebtedness or the provider of Indebtedness (if provided on a bilateral basis), as the case may be.

“*Restricted Investment*” means any Investment other than a Permitted Investment.

“*Restricted Subsidiary*” means a Subsidiary of Altice International other than an Unrestricted Subsidiary.

“*Revolving Credit Facilities*” means the Existing Revolving Credit Facilities and the Additional Revolving Credit Facilities.

“*S&P*” means Standard & Poor’s Investors Ratings Services or any of its successors or assigns that is a Nationally Recognized Statistical Rating Organization.

“*SEC*” means the U.S. Securities and Exchange Commission.

“*Securities Act*” means the U.S. Securities Act of 1933, as amended, and the rules and regulations of the SEC promulgated thereunder, as amended.

“*Security Agent*” means Citibank, N.A., London Branch acting as security agent pursuant to the Intercreditor Agreement or such successor Security Agent or any delegate thereof as may be appointed thereunder or any such security agent, successor or delegate thereof pursuant to an Additional Intercreditor Agreement.

“*Security Documents*” means the security agreements, pledge agreements, collateral assignments, and any other instrument and document executed and delivered pursuant to the Indenture or otherwise or any of the foregoing, as the

same may be amended, supplemented or otherwise modified from time to time, creating the security interests in the Notes Collateral as contemplated by the Indenture.

“*Senior Credit Facilities*” means the Existing Senior Credit Facility and the New Senior Credit Facility.

“*Senior Indebtedness*” means, whether outstanding on the Issue Date or thereafter Incurred:

- (1) all Indebtedness of the Issuer or any Guarantor outstanding under the Revolving Credit Facilities, Senior Credit Facilities, the Guarantee Facility, all Hedging Obligations and all Obligations with respect to any of the foregoing;
- (2) the Senior Secured Notes, the New Senior Secured Notes and Guarantees thereof; and
- (3) any other Indebtedness of the Issuer or any Guarantor permitted to be incurred under the terms of the Indenture, unless the instrument under which such Indebtedness is Incurred (or the Intercreditor Agreement or any Additional Intercreditor Agreement to which such Indebtedness is subject) expressly provides, in the case of the Issuer, that it is subordinated in right of payment to the Notes, or in the case of any Guarantor, that it is on a parity with or subordinated in right of payment to the Note Guarantee of such Guarantor, including, without limitation, any Subordinated Indebtedness, and all Obligations with respect to any of the foregoing.

Notwithstanding anything to the contrary in the preceding, Senior Indebtedness will not include:

- (1) any liability for national, state, local or other taxes owed or owing by Altice International or any Restricted Subsidiary;
- (2) any (i) Indebtedness of Altice International owing to and held by any Restricted Subsidiary, (ii) Indebtedness of a Restricted Subsidiary owing to and held by Altice International or any other Restricted Subsidiary or (iii) any Indebtedness of Altice International or any Restricted Subsidiary owing to any of Affiliate of Altice International;
- (3) any trade payables;
- (4) the portion of any Indebtedness that is incurred in violation of the Indenture; or
- (5) Indebtedness which is classified as non-recourse in accordance with IFRS or any unsecured claim arising in respect of any insolvency proceedings.

“*Senior Secured Indebtedness*” means, with respect to any Person as of any date of determination, any Indebtedness for borrowed money that is Incurred by Altice International or any Restricted Subsidiary (other than the Issuer) under clause (1) of the first paragraph of the covenant described under “*Certain Covenants—Limitation on Indebtedness*” or clauses (1), (4)(b), (5), (7), (14) or (15) of the second paragraph of the covenant described under “*Certain Covenants—Limitation on Indebtedness*” and any Refinancing Indebtedness in respect of the foregoing; *provided* that, if such Indebtedness is Incurred by the Issuer or any Guarantor, such Indebtedness (other than Indebtedness Incurred pursuant to clause (4)(b) of the second paragraph of the covenant described under “*Certain Covenants—Limitation on Indebtedness*”) is in each case secured by a Lien (other than (i) Liens on the Capital Stock of the Senior Secured Notes Issuer, Cool and Altice Holding and (ii) Liens on the Proceeds Loans and Subordinated Shareholder Loan, if any, in each case, that secure *Pari Passu* Indebtedness of the Guarantors that also secure the Notes and the Guarantees thereof).

“*Senior Secured Notes*” means the Existing Senior Secured Notes and the New Senior Secured Notes.

“*Senior Secured Notes Indentures*” means the Existing Senior Secured Notes Indenture and the New Senior Secured Notes Indenture.

“*Senior Secured Notes Issuer*” means Altice Financing S.A., a Luxembourg public limited liability company (*société anonyme*) with registered office at 3 Boulevard Royal, L-2449 Luxembourg.

“*Senior Secured Notes Security Documents*” means the security agreements, pledge agreements, collateral assignments, and any other instrument and document executed and delivered pursuant to the Indenture or otherwise or any of the foregoing, as the same may be amended, supplemented or otherwise modified from time to time, creating the security interests in the collateral securing the Senior Secured Notes as contemplated by the Senior Secured Notes Indentures.

“*Significant Subsidiary*” means any Restricted Subsidiary that meets any of the following conditions:

- (1) Altice International's and the Restricted Subsidiaries' investments in and advances to the Restricted Subsidiary exceed 10% of the total assets of Altice International on a consolidated basis as of the end of the most recently completed fiscal year;
- (2) Altice International's and the Restricted Subsidiaries' proportionate share of the total assets (after intercompany eliminations) of the Restricted Subsidiary exceeds 10% of the total assets of Altice International on a consolidated basis as of the end of the most recently completed fiscal year; or
- (3) if positive, Altice International's and the Restricted Subsidiaries' equity in the income from continuing operations before income taxes, extraordinary items and cumulative effect of a change in accounting principle of the Restricted Subsidiary exceeds 10% of such income of Altice International on a consolidated basis for the most recently completed fiscal year.

“*Similar Business*” means (a) any businesses, services or activities (including marketing) engaged in by Altice International, the Target or any of their Subsidiaries on the Issue Date, (b) broadcast television, broadband and fixed and mobile telephony businesses, including the distribution, sale and for provision of mobile voice and data, fixed-line voice and internet services, transit voice traffic services and other services and equipment in relation thereto and (c) any businesses, services and activities (including marketing) engaged in by Altice International, the Target or any of their Subsidiaries that are (i) related, complementary, incidental, ancillary or similar to any of the foregoing or (ii) are reasonable extensions or developments of any thereof.

“*Standard Securitization Undertakings*” means representations, warranties, covenants, indemnities and guarantees of performance entered into by Altice International or any Subsidiary of Altice International which the Issuer has determined in good faith to be customary in a Receivables Financing, including those relating to the servicing of the assets of a Receivables Subsidiary, it being understood that any Receivables Repurchase Obligation shall be deemed to be a Standard Securitization Undertaking.

“*Stated Maturity*” means, with respect to any installment of interest or principal on any series of Indebtedness, the date on which the payment of interest or principal was scheduled to be paid in the original documentation governing such Indebtedness, and will not include any contingent obligations to repay, redeem or repurchase any such interest or principal prior to the date originally scheduled for the payment thereof.

“*Subordinated Indebtedness*” means, in the case of the Issuer, any Indebtedness (whether outstanding on the Issue Date or thereafter Incurred) which is expressly subordinated or junior in right of payment to the Notes or pursuant to a written agreement and, in the case of a Guarantor, any Indebtedness (whether outstanding on the Issue Date or thereafter Incurred) which is expressly subordinated or junior in right of payment to the Note Guarantee of such Guarantor.

“*Subordinated Shareholder Funding*” means, collectively, any funds provided to Altice International by any Parent, any Affiliate of any Parent or any Permitted Holder or any Affiliate thereof, in exchange for or pursuant to any security, instrument or agreement other than Capital Stock, in each case issued to and held by any of the foregoing Persons, together with any such security, instrument or agreement and any other security or instrument other than Capital Stock issued in payment of any obligation under any Subordinated Shareholder Funding; *provided, however*, that such Subordinated Shareholder Funding:

- (1) does not mature or require any amortization, redemption or other repayment of principal or any sinking fund payment prior to the first anniversary of the Stated Maturity of the Notes (other than through conversion or exchange of such funding into Capital Stock (other than Disqualified Stock) of Altice International or any funding meeting the requirements of this definition) or the making of any such payment prior to the first anniversary of the Stated Maturity of the Notes is restricted by the Intercreditor Agreement, an Additional Intercreditor Agreement or another intercreditor agreement;
- (2) does not require, prior to the first anniversary of the Stated Maturity of the Notes, payment of cash interest, cash withholding amounts or other cash gross-ups, or any similar cash amounts or the making of any such payment prior to the first anniversary of the Stated Maturity of the Notes is restricted by the Intercreditor Agreement or an Additional Intercreditor Agreement;
- (3) contains no change of control or similar provisions and does not accelerate and has no right to declare a default or event of default or take any enforcement action or otherwise require any cash payment, in each case, prior to the date that is six months following the Stated Maturity of the Notes or the payment of any amount as a result of any such action or provision or the exercise of any rights or enforcement action, in each case, prior to the date that is six months following the Stated Maturity of the Notes, is restricted by the Intercreditor Agreement or an Additional Intercreditor Agreement;

- (4) does not provide for or require any security interest or encumbrance over any asset of Altice International or any of the Restricted Subsidiaries; and
- (5) pursuant to its terms or to the Intercreditor Agreement, an Additional Intercreditor Agreement or another intercreditor agreement, is fully subordinated and junior in right of payment to the Notes pursuant to subordination, payment blockage and enforcement limitation terms which are customary in all material respects for similar funding or are no less favorable in any material respect to Holders than those contained in the Intercreditor Agreement as in effect on the Issue Date.

For the avoidance of doubt, Subordinated Shareholder Funding shall include the AI Mandatory Convertible Notes so long as it satisfies the conditions set forth in (1) to (5) above.

“*Subordinated Shareholder Loan*” means the amended and restated interest free loan agreement dated January 11, 2013 between Altice International and Cool pursuant to which Altice International agreed to grant Cool a loan in a maximum aggregate amount of NIS 1.5 billion.

“*Subsidiary*” means, with respect to any Person:

- (1) any corporation, association, or other business entity (other than a partnership, joint venture, limited liability company or similar entity) of which more than 50% of the total ordinary voting power of shares of Capital Stock entitled (without regard to the occurrence of any contingency) to vote in the election of directors, managers or trustees thereof is at the time of determination owned or controlled, directly or indirectly, by such Person or one or more of the other Subsidiaries of that Person or a combination thereof; or
- (2) any partnership, joint venture, limited liability company or similar entity of which:
 - (a) more than 50% of the capital accounts, distribution rights, total equity and voting interests or general or limited partnership interests, as applicable, are owned or controlled, directly or indirectly, by such Person or one or more of the other Subsidiaries of that Person or a combination thereof whether in the form of membership, general, special or limited partnership interests or otherwise; and
 - (b) such Person or any Subsidiary of such Person is a controlling general partner or otherwise controls such entity.

“*Subsidiary Guarantor*” means any Restricted Subsidiary (other than the Issuer and the Senior Secured Notes Issuer) that Guarantees the Notes.

“*Target*” means PT Portugal SGPS, S.A., a public limited liability company (*sociedade anónima*) incorporated under the laws of Portugal.

“*Taxes*” has the meaning given to such term under “*Withholding Taxes*”.

“*Tax Sharing Agreement*” means any tax sharing or profit and loss pooling or similar agreement with customary or arm’s-length terms entered into with any Parent or Unrestricted Subsidiary, as the same may be amended, supplemented, waived or otherwise modified from time to time in accordance with the terms thereof and of the Indenture.

“*Temporary Cash Investments*” means any of the following:

- (1) any investment in
 - (a) direct obligations of, or obligations Guaranteed by, (i) the United States of America, (ii) any European Union member state, (iii) the State of Israel, (iv) any country in whose currency funds are being held specifically pending application in the making of an investment or capital expenditure by Altice International or a Restricted Subsidiary in that country with such funds or (v) any agency or instrumentality of any such country or member state, or
 - (b) direct obligations of any country recognized by the United States of America rated at least “A” by S&P or “A-1” by Moody’s (or, in either case, the equivalent of such rating by such organization or, if no rating of S&P or Moody’s then exists, the equivalent of such rating by any Nationally Recognized Statistical Rating Organization);

- (2) overnight bank deposits, and investments in time deposit accounts, certificates of deposit, bankers' acceptances and money market deposits (or, with respect to foreign banks, similar instruments) maturing not more than one year after the date of acquisition thereof issued by:
 - (a) any institution authorized to operate as a bank in any of the countries or member states referred to in subclause (1)(a) above, or
 - (b) any bank or trust company organized under the laws of any such country or member state or any political subdivision thereof,

in each case, having capital and surplus aggregating in excess of €250 million (or the foreign currency equivalent thereof) and whose long-term debt is rated at least "A" by S&P or "A-2" by Moody's (or, in either case, the equivalent of such rating by such organization or, if no rating of S&P or Moody's then exists, the equivalent of such rating by any Nationally Recognized Statistical Rating Organization) at the time such Investment is made;

- (3) repurchase obligations with a term of not more than 30 days for underlying securities of the types described in clause (1) or (2) above entered into with a Person meeting the qualifications described in clause (2) above;
- (4) Investments in commercial paper, maturing not more than 270 days after the date of acquisition, issued by a Person (other than Altice International or any of its Subsidiaries), with a rating at the time as of which any Investment therein is made of "P-2" (or higher) according to Moody's or "A-2" (or higher) according to S&P (or, in either case, the equivalent of such rating by such organization or, if no rating of S&P or Moody's then exists, the equivalent of such rating by any Nationally Recognized Statistical Rating Organization);
- (5) Investments in securities maturing not more than one year after the date of acquisition issued or fully Guaranteed by any state, commonwealth or territory of the United States of America, any European Union member state or by any political subdivision or taxing authority of any such state, commonwealth, territory, country or member state, and rated at least "BBB-" by S&P or "Baa3" by Moody's (or, in either case, the equivalent of such rating by such organization or, if no rating of S&P or Moody's then exists, the equivalent of such rating by any Nationally Recognized Statistical Rating Organization);
- (6) bills of exchange issued in the United States of America or a member state of the European Union eligible for rediscount at the relevant central bank and accepted by a bank (or any dematerialized equivalent);
- (7) any money market deposit accounts issued or offered by a commercial bank organized under the laws of a country that is a member of the Organization for Economic Co-operation and Development, in each case, having capital and surplus in excess of €250 million (or the foreign currency equivalent thereof) or whose long term debt is rated at least "A" by S&P or "A-2" by Moody's (or, in either case, the equivalent of such rating by such organization or, if no rating of S&P or Moody's then exists, the equivalent of such rating by any Nationally Recognized Statistical Rating Organization) at the time such Investment is made;
- (8) investment funds investing 95% of their assets in securities of the type described in clauses (1) through (7) above (which funds may also hold reasonable amounts of cash pending investment and/or distribution); and
- (9) investments in money market funds complying with the risk limiting conditions of Rule 2a-7 (or any successor rule) of the SEC under the U.S. Investment Company Act of 1940, as amended.

"*Total Assets*" means the consolidated total assets of Altice International and the Restricted Subsidiaries as shown on the most recent consolidated balance sheet of Altice International prepared on the basis of IFRS prior to the relevant date of determination calculated to give *pro forma* effect to any Purchase and Sales that have occurred subsequent to such period, including any such Purchase to be made with the proceeds of such Indebtedness giving rise to the need to calculate Total Assets.

"*Treasury Rate*" means, as of the applicable redemption date, the yield to maturity as of such redemption date of United States Treasury securities with a constant maturity (as compiled and published in the most recent Federal Reserve Statistical Release H. 15 (519) that has become publicly available at least two (2) Business Days prior to such redemption date (or, if such Statistical Release is no longer published, any publicly available source of similar market data)) most nearly equal to the period from such redemption date to February 15, 2020; *provided* that if the period from such redemption date to February 15, 2020 is less than one year, the weekly average yield on actually traded United States Treasury securities adjusted to a constant maturity of one year will be used.

"*Tricom*" means Tricom S.A., a *sociedad anónima* incorporated and existing under the laws of the Dominican Republic.

“U.S. GAAP” means generally accepted accounting principles in the United States of America as in effect from time to time.

“Uniform Commercial Code” means the New York Uniform Commercial Code.

“Unrestricted Subsidiary” means:

- (1) Green Datacenter and Auberimmo SAS;
- (2) any Subsidiary of Altice International that at the time of determination is an Unrestricted Subsidiary (as designated by the Board of Directors of Altice International in the manner provided below); and
- (3) any Subsidiary of an Unrestricted Subsidiary.

The Board of Directors of Altice International may designate any Subsidiary of Altice International (other than the Issuer or the Senior Secured Notes Issuer) (including any newly acquired or newly formed Subsidiary or a Person becoming a Subsidiary through merger, consolidation or other business combination transaction, or Investment therein) to be an Unrestricted Subsidiary only if:

- (1) such Subsidiary or any of its Subsidiaries does not own any Capital Stock or Indebtedness of, or own or hold any Lien on any property of, Altice International or any other Subsidiary of Altice International which is not a Subsidiary of the Subsidiary to be so designated or otherwise an Unrestricted Subsidiary; and
- (2) such designation and the Investment of Altice International and the Restricted Subsidiaries in such Subsidiary complies with “—*Certain Covenants—Limitation on Restricted Payments*”.

Any such designation by the Board of Directors of Altice International shall be evidenced to the Trustee by filing with the Trustee a copy of the resolution of the Board of Directors of Altice International giving effect to such designation and an Officer’s Certificate certifying that such designation complies with the foregoing conditions.

The Board of Directors of Altice International may designate any Unrestricted Subsidiary to be a Restricted Subsidiary; *provided* that immediately after giving effect to such designation (1) no Default or Event of Default would result therefrom and (2) (x) the Issuer could Incur at least €1.00 of additional Indebtedness under the first paragraph of the covenant described under “—*Certain Covenants—Limitation on Indebtedness*” or (y) the Consolidated Net Leverage Ratio would be no higher than it was immediately prior to giving effect to such designation, in each case, on a *pro forma* basis taking into account such designation. Any such designation by the Board of Directors shall be evidenced to the Trustee by promptly filing with the Trustee a copy of the resolution of the Board of Directors giving effect to such designation or an Officer’s Certificate certifying that such designation complied with the foregoing provisions.

“*Voting Stock*” of a Person means all classes of Capital Stock of such Person then outstanding and normally entitled to vote in the election of directors.

“*Wholly Owned Subsidiary*” means a Restricted Subsidiary of a Person, all of the Capital Stock of which (other than directors’ qualifying shares or shares required by any applicable law or regulation to be held by a Person other than such Person or another Wholly Owned Subsidiary of such Person) is owned by such Person or another Wholly Owned Subsidiary of such Person.

“*Winreason*” means Winreason—S.A., a public limited liability company (*sociedade anónima*) incorporated under the laws of Portugal.

BOOK-ENTRY, DELIVERY AND FORM

General

Each series of the New Notes sold outside the United States pursuant to Regulation S will initially be represented by one or more global notes in registered form without interest coupons attached (the “Regulation S Global Notes”). The Regulation S Global Notes representing the Dollar Senior Secured Notes and the New Senior Notes (the “Dollar Regulation S Global Notes”) were deposited upon issuance with Deutsche Bank Trust Company Americas, as custodian for DTC and registered in the name of Cede & Co., as nominee of DTC. The Regulation S Global Notes representing the Euro Senior Secured Notes (the “Euro Regulation S Global Notes”) were deposited, on the Issue Date, with a common depository and registered in the name of the nominee of the common depository for the accounts of Euroclear and Clearstream.

Each series of the New Notes sold within the United States to “qualified institutional buyers” pursuant to Rule 144A will initially be represented by one or more global notes in registered form without interest coupons attached (the “144A Global Notes” and, together with the Regulation S Global Notes, the “Global Notes”). The 144A Global Notes representing the Dollar Senior Secured Notes and the New Senior Notes (the “Dollar 144A Global Notes”) were deposited upon issuance with Deutsche Bank Trust Company Americas, as custodian for DTC and registered in the name of Cede & Co., as nominee of DTC. The 144A Global Notes representing the Euro Senior Secured Notes (the “Euro 144A Global Notes”) were deposited, on the Issue Date, with a common depository and registered in the name of the nominee of the common depository for the accounts of Euroclear and Clearstream.

The Dollar 144A Global Notes and the Dollar Regulation S Global Notes are collectively referred to herein as the “Dollar Global Notes”. The Euro 144A Global Notes and the Euro Regulation S Global Notes are collectively referred to herein as the “Euro Global Notes”.

Ownership of interests in the 144A Global Notes (the “144A Book-Entry Interests”) and ownership of interests in the Regulation S Global Notes (the “Regulation S Book-Entry Interests” and, together with the 144A Book-Entry Interests, the “Book-Entry Interests”) will be limited to persons that have accounts with DTC, Euroclear and/or Clearstream or persons that may hold interests through such participants. Book-Entry Interests will be shown on, and transfers thereof will be effected only through, records maintained in book-entry form by DTC, Euroclear and Clearstream and their participants. The Book-Entry Interests in the Euro Global Notes will be issued only in denominations of €100,000 and in integral multiples of €1,000 in excess thereof and the Book-Entry Interests in the Dollar Global Notes will be issued only in denominations of \$200,000 and integral multiples of \$1,000 in excess thereof.

The Book-Entry Interests will not be held in definitive form. Instead, DTC, Euroclear and/or Clearstream, as applicable, will credit on their respective book-entry registration and transfer systems a participant’s account with the interest beneficially owned by such participant. The laws of some jurisdictions, including certain states of the United States, may require that certain purchasers of securities take physical delivery of such securities in definitive form. The foregoing limitations may impair the ability to own, transfer or pledge Book-Entry Interests. In addition, while the New Notes are in global form, owners of interest in the Global Notes will not have the New Notes registered in their names, will not receive physical delivery of the New Notes in certificated form and will not be considered the registered owners or “holders” of the New Notes, under each of the New Indentures for any purpose.

So long as the New Notes are held in global form, the common depositories for DTC, Euroclear and/or Clearstream (or their respective nominees), as applicable, will be considered the sole holders of Global Notes for all purposes under each of the New Indentures. As such, participants must rely on the procedures of DTC, Euroclear and/or Clearstream, as applicable, and indirect participants must rely on the procedures of DTC, Euroclear and/or Clearstream, as applicable, and the participants through which they own Book-Entry Interests in order to exercise any rights of holders under each of the New Indentures.

Neither we, the Registrar, Deutsche Bank Trust Company Americas, as custodian for DTC the common depository for the accounts of Euroclear and Clearstream nor the Trustee under each of the New Indentures nor any of our or their respective agents will have any responsibility or be liable for any aspect of the records relating to the Book-Entry Interests.

Issuance of Definitive Registered Notes

Under the terms of each of the New Indentures, owners of Book-Entry Interests will receive definitive New Notes in registered form (the “Definitive Registered Notes”):

- if DTC (with respect to the Dollar Global Notes), or Euroclear and Clearstream (with respect to the Euro Global Notes) notify the applicable Issuer that it is unwilling or unable to continue to act as depositary and a successor depositary is not appointed by the applicable Issuer within 120 days,
- if DTC (with respect to the Dollar Global Notes), or Euroclear or Clearstream (with respect to the Euro Global Notes) so requests following an event of default under the relevant Indenture, or
- if the owner of a Book-Entry Interest requests such exchange in writing delivered through DTC, Euroclear and/or Clearstream, as applicable, following an event of default under the applicable New Indenture.

In such an event, the Registrar will issue Definitive Registered Notes, registered in the name or names and issued in any approved denominations, requested by or on behalf of DTC, Euroclear and/or Clearstream, as applicable, or the applicable Issuer, as applicable (in accordance with their respective customary procedures and based upon directions received from participants reflecting the beneficial ownership of Book-Entry Interests), and such Definitive Registered Notes will bear the restrictive legend referred to in “*Transfer Restrictions*”, unless that legend is not required by the applicable New Indenture or applicable law.

To the extent permitted by law, we, the Trustee, the Paying Agents, the transfer agent and the Registrar shall be entitled to treat the registered holder of any Global Note as the absolute owner thereof and no person will be liable for treating the registered holder as such.

We will not impose any fees or other charges in respect of the New Notes, however, owners of the Book-Entry Interests may incur fees normally payable in respect of the maintenance and operation of accounts in DTC, Euroclear and/or Clearstream, as applicable.

Redemption of the Global Notes

In the event any Global Note, or any portion thereof, is redeemed, DTC, Euroclear and/or Clearstream, as applicable, will distribute the amount received by it in respect of the Global Note so redeemed to the holders of the Book-Entry Interests in such Global Note from the amount received by it in respect of the redemption of such Global Note. The redemption price payable in connection with the redemption of such Book-Entry Interests will be equal to the amount received by DTC, Euroclear or Clearstream, as applicable, in connection with the redemption of such Global Note (or any portion thereof). We understand that under existing practices of DTC, Euroclear and Clearstream, if fewer than all of the New Notes are to be redeemed at any time, DTC, Euroclear and Clearstream will credit their respective participants’ accounts on a proportionate basis (with adjustments to prevent fractions) or on such other basis as they deem fair and appropriate, *provided, however*, that no Book-Entry Interest of less than €100,000, in the case of the Euro Global Notes, or \$200,000, in the case of the Dollar Global Notes, principal amount at maturity, or less, may be redeemed in part.

Payments on Global Notes

Payments of any amounts owing in respect of the Global Notes (including principal, premium, interest, additional interest and additional amounts) will be made by each of the Issuers to the Principal Paying Agent. The Principal Paying Agent will, in turn, make such payments to Euroclear and Clearstream (in the case of the Euro Global Notes) and to DTC or its nominee (in the case of the Dollar Global Notes), which will distribute such payments to participants in accordance with their respective procedures.

Under the terms of each of the New Indentures, the Issuers, the Trustee the Registrar, the transfer agents and the Paying Agents will treat the registered holder of the Global Notes (for example, DTC, Euroclear or Clearstream (or their respective nominees)) as the owner thereof for the purpose of receiving payments and for all other purposes. Consequently, neither we, the Trustee, the Registrar the transfer agents nor the Paying Agents or any of their respective agents has or will have any responsibility or liability for:

- any aspects of the records of DTC, Euroclear, Clearstream or any participant or indirect participant relating to or payments made on account of a Book-Entry Interest, for any such payments made by DTC, Euroclear, Clearstream or any participant or indirect participant, or for maintaining, supervising or reviewing the records of DTC, Euroclear, Clearstream or any participant or indirect participant relating to, or payments made on account of, a Book-Entry Interest, or
- payments made by DTC, Euroclear, Clearstream or any participant or indirect participant, or for maintaining, supervising or reviewing the records of DTC, Euroclear, Clearstream or any participant or indirect participant relating to or payments made on account of a Book-Entry Interest, or
- DTC, Euroclear, Clearstream or any participant or indirect participant.

Payments by participants to owners of Book-Entry Interests held through participants are the responsibility of such participants, as is now the case with securities held for the accounts of subscribers registered in “street name”.

Currency and Payment for the Global Notes

The principal of, premium, if any, and interest on, and all other amounts payable in respect of, the Euro Global Notes will be paid to holders of interest in such New Notes (each a “Euroclear/Clearstream Holder” and together, the “Euroclear/Clearstream Holders”) through Euroclear and/or Clearstream, as applicable, in euro. The principal of, premium, if any, and interest on, and all other amounts payable in respect of, the Dollar Global Notes will be paid to holders of interest in such Notes (each a “DTC Holder” and together, the “DTC Holders”) through DTC in U.S. dollars.

Notwithstanding the payment provisions described above, Euroclear/Clearstream Holders may elect to receive payments in respect of the Euro Global Notes in U.S. dollars and DTC Holders may elect to receive payments in respect of the Dollar Global Notes in euro.

If so elected, a Euroclear/Clearstream Holder may receive payments of amounts payable in respect of its interest in the Euro Global Notes in U.S. dollars in accordance with Euroclear or Clearstream’s customary procedures, which include, among other things, giving to Euroclear or Clearstream, as appropriate, a notice of such holder’s election. All costs of conversion resulting from any such election will be borne by such Euroclear/Clearstream Holder.

If so elected, a DTC Holder may receive payment of amounts payable in respect of its interest in the Dollar Global Notes in euro in accordance with DTC’s customary procedures, which include, among other things, giving to DTC a notice of such holder’s election to receive payments in euro. All costs of conversion resulting from any such election will be borne by such DTC Holder.

Action by Owners of Book-Entry Interests

DTC, Euroclear and Clearstream have advised the Issuers that they will take any action permitted to be taken by a holder of the New Notes only at the direction of one or more participants to whose account the Book-Entry Interests in the Global Notes are credited and only in respect of such portion of the aggregate principal amount of the New Notes as to which such participant or participants has or have given such direction. DTC, Euroclear and Clearstream will not exercise any discretion in the granting of consents, waivers or the taking of any other action in respect of the Global Notes. However, if there is an event of default under any of the New Indentures, each of DTC, Euroclear and Clearstream reserves the right to exchange the Global Notes for Definitive Registered Notes in certificated form, and to distribute such Definitive Registered Notes to their respective participants.

Transfers

Transfers between participants in DTC will be done in accordance with DTC rules and will be settled in immediately available funds. If a holder requires physical delivery of Definitive Registered Notes for any reason, including to sell the New Notes to persons in states which require physical delivery of such securities or to pledge such securities, such holder must transfer its interest in the Global Notes in accordance with the normal procedures of DTC and in accordance with the provisions of each of the Indentures.

The Global Notes will bear a legend to the effect set forth in “*Transfer Restrictions*”. Book-Entry Interests in the Global Notes will be subject to the restrictions on transfer discussed in “*Transfer Restrictions*”.

Through and including the 40th day after the later of the commencement of the offering of the New Notes and the closing of the offering (the “40-day Period”), beneficial interests in a Regulation S Global Note may be transferred to a person who takes delivery in the form of an interest in the Rule 144A Global Note denominated in the same currency only if such transfer is made pursuant to Rule 144A and the transferor first delivers to the Trustee a certificate (in the form provided in each of the New Indentures) to the effect that such transfer is being made to a person who the transferor reasonably believes is a “qualified institutional buyer” within the meaning of Rule 144A in a transaction meeting the requirements of Rule 144A or otherwise in accordance with the transfer restrictions described under “*Transfer Restrictions*” and in accordance with all applicable securities laws of the states of the United States and other jurisdictions.

After the expiration of the 40-day Period, beneficial interests in a Regulation S Global Note may be transferred to a person who takes delivery in the form of a beneficial interest in the Rule 144A Global Note denominated in the same currency without compliance with these certification requirements.

Beneficial interests in a Rule 144A Global Note may be transferred to a person who takes delivery in the form of a beneficial interest in the Regulation S Global Note denominated in the same currency only upon receipt by the Trustee of

a written certification (in the form provided in each of the New Indentures) from the transferor to the effect that such transfer is being made in accordance with Regulation S or Rule 144 (if available).

Subject to the foregoing, and as set forth in “*Transfer Restrictions*”, Book-Entry Interests may be transferred and exchanged as described under “*Description of New Senior Secured Notes—Transfer and Exchange*” and “*Description of New Senior Notes—Transfer and Exchange*”. Any Book-Entry Interest in one of the Global Notes that is transferred to a person who takes delivery in the form of a Book-Entry Interest in the other Global Note of the same denomination will, upon transfer, cease to be a Book-Entry Interest in the first-mentioned Global Note and become a Book-Entry Interest in the other Global Note, and accordingly, will thereafter be subject to all transfer restrictions, if any, and other procedures applicable to Book-Entry Interests in such other Global Note for as long as it retains such a Book-Entry Interest.

Definitive Registered Notes may be transferred and exchanged for Book-Entry Interests in a Global Note only as described under “*Description of Senior Secured Notes—Transfer and Exchange*” and “*Description of Senior Notes—Transfer and Exchange*” and, if required, only if the transferor first delivers to the Trustee a written certificate (in the form provided in each of the New Indentures) to the effect that such transfer will comply with the appropriate transfer restrictions applicable to such New Notes. See “*Transfer Restrictions*”.

This paragraph refers to transfers and exchanges with respect to Dollar Global Notes only. Transfers involving an exchange of a Regulation S Book-Entry Interest for 144A Book-Entry Interest in a Dollar Global Note will be done by DTC by means of an instruction originating from the Trustee through the DTC Deposit/Withdrawal Custodian system. Accordingly, in connection with any such transfer, appropriate adjustments will be made to reflect a decrease in the principal amount of the relevant Regulation S Global Note and a corresponding increase in the principal amount of the corresponding 144A Global Note. The policies and practices of DTC may prohibit transfers of unrestricted Book-Entry Interests in the Regulation S Global Note prior to the expiration of the 40 days after the date of initial issuance of the Notes. Any Book-Entry Interest in one of the Global Notes that is transferred to a person who takes delivery in the form of a Book-Entry Interest in any other Global Note will, upon transfer, cease to be a Book-Entry Interest in the first mentioned Global Note and become a Book-Entry interest in such other Global Note, and accordingly will thereafter be subject to all transfer restrictions, if any, and other procedures applicable to Book-Entry Interests in such other Global Note for as long as it remains such a Book-Entry Interest.

Information Concerning DTC, Euroclear and Clearstream

All Book-Entry Interests will be subject to the operations and procedures of DTC, Euroclear and Clearstream, as applicable. We provide the following summaries of those operations and procedures solely for the convenience of investors. The operations and procedures of each settlement system are controlled by that settlement system and may be changed at any time. Neither we, the Trustee, the Registrar, the transfer agents and the Paying Agents nor the Initial Purchasers are responsible for those operations or procedures. DTC has advised the Issuers that it is:

- a limited purpose trust company organized under New York Banking Law,
- a “banking organization” within the meaning of New York Banking Law,
- a member of the Federal Reserve System,
- a “clearing corporation” within the meaning of the New York Uniform Commercial Code, and
- a “clearing agency” registered pursuant to the provision of Section 17A of the U.S. Securities Exchange Act of 1934, as amended (the “U.S. Exchange Act”).

DTC holds and provides asset servicing for issues of U.S. and non-U.S. equity issues, corporate and municipal debt issues, and money market instruments (that DTC’s direct participants deposit with DTC). DTC also facilitates the post-trade settlement among direct participants of sales and other securities transactions in deposited securities, through electronic book- entry transfers and pledges between direct participants’ accounts. DTC is a wholly owned subsidiary of The Depository Trust & Clearing Corporation (“DTCC”). DTCC is the holding company for DTC, National Securities Clearing Corporation and Fixed Income Clearing Corporation, all of which are registered clearing agencies. DTCC is owned by the users of its regulated subsidiaries. Access to the DTC system is also available to others such as both U.S. and non-U.S. securities brokers and dealers, banks, trust companies and clearing corporations that clear through or maintain a custodial relationship with a direct participant, either directly or indirectly.

Like DTC, Euroclear and Clearstream hold securities for participating organizations. They also facilitate the clearance and settlement of securities transactions between their respective participants through electronic book- entry changes in the accounts of such participants. Euroclear and Clearstream provide to their participants, among other things, services for safekeeping, administration, clearance, settlement, lending and borrowing of internationally traded securities.

Euroclear and Clearstream interface with domestic securities markets. Euroclear and Clearstream participants are financial institutions, such as underwriters, securities brokers and dealers, banks, trust companies and certain other organizations. Indirect access to Euroclear and/or Clearstream is also available to others, such as banks, brokers, dealers and trust companies that clear through or maintain a custodian relationship with a Euroclear and/or Clearstream participant, either directly or indirectly.

Because DTC, Euroclear and Clearstream can only act on behalf of participants, who in turn act on behalf of indirect participants and certain banks, the ability of an owner of a beneficial interest to pledge such interest to persons or entities that do not participate in the DTC, Euroclear or Clearstream systems, or otherwise take actions in respect of such interest, may be limited by the lack of a definite certificate for that interest. The laws of some jurisdictions require that certain persons take physical delivery of securities in definitive form. Consequently, the ability to transfer beneficial interests to such person may be limited. In addition, owners of beneficial interests through the DTC, Euroclear or Clearstream systems will receive distributions attributable to the 144A Global Notes only through DTC, Euroclear or Clearstream participants.

Global Clearance and Settlement Under the Book-Entry System

The New Notes represented by the Global Notes are expected to be admitted to the Official List of the Luxembourg Stock Exchange and to be admitted to trading on the Euro MTF market thereof and to trade in DTC's Same-Day Funds Settlement System, and any permitted secondary market trading activity in such New Notes will therefore be required by DTC to be settled in immediately available funds. The Issuers expect that secondary trading in any certificated New Notes will also be settled in immediately available funds. Subject to compliance with the transfer restrictions applicable to the Global Notes, cross market transfers between participants in DTC, on the one hand, and Euroclear or Clearstream participants, on the other hand, will be done through DTC in accordance with DTC's rules on behalf of each of Euroclear or Clearstream by its common depository, however, such cross market transactions will require delivery of instructions to Euroclear or Clearstream by the counterparty in such system in accordance with the rules and regulations and within the established deadlines of such system (Brussels time). Euroclear or Clearstream will, if the transaction meets its settlement requirements, deliver instructions to the common depository to take action to effect final settlement on its behalf by delivering or receiving interests in the Global Notes by DTC, and making and receiving payment in accordance with normal procedures for same-day funds settlement application to DTC. Euroclear participants and Clearstream participants may not deliver instructions directly to the common depository.

Because of the time zone differences, the securities account of a Euroclear or Clearstream participant purchasing an interest in a Global Note from a participant in DTC will be credited, and any such crediting will be reported to the relevant Euroclear or Clearstream participant, during the securities settlement processing day (which must be a business day for Euroclear and Clearstream) immediately following the settlement date of DTC. Cash received in Euroclear and Clearstream as a result of a sale of an interest in a Global Note by or through a Euroclear or Clearstream participant to a participant in DTC, will be received with value on the settlement date of DTC, but will be available in the relevant Euroclear or Clearstream cash account only as of the business day for Euroclear or Clearstream following DTC's settlement date.

Although DTC, Euroclear and Clearstream currently follow the foregoing procedures in order to facilitate transfers of interests in the Global Notes among participants in DTC, Euroclear or Clearstream, as the case may be, they are under no obligation to perform or continue to perform such procedures, and such procedures may be discontinued or modified at any time. Neither we, the Trustee, the Registrar, the transfer agents nor the Paying Agent will have any responsibility for the performance by DTC, Euroclear or Clearstream or their respective participants or indirect participants, of their respective obligations under the rules and procedures governing their operations.

Initial Settlement

Initial settlement for the New Notes will be made in euro and U.S. dollars. Book-Entry Interests owned through DTC, Euroclear or Clearstream accounts will follow the settlement procedures applicable to conventional Eurobonds in registered form. Book-Entry Interests will be credited to the securities custody accounts of DTC, Euroclear and Clearstream holders on the business day following the settlement date against payment for value on the settlement date.

Secondary Market Trading

Application has been made to the Luxembourg Stock Exchange for the New Notes represented by the Global Notes to be admitted to listing on the official list of the Luxembourg Stock Exchange and trading on its Euro MTF Market. We expect that secondary trading in the New Notes will also be settled in immediately available funds.

The Book-Entry Interests will trade through participants of DTC and Euroclear or Clearstream and will settle in same-day funds. Since the purchase determines the place of delivery, it is important to establish at the time of trading of

any Book-Entry Interests where both the purchaser's and the seller's accounts are located to ensure that settlement can be made on the desired value date.

TRANSFER RESTRICTIONS

The New Notes have not been registered under the U.S. Securities Act or any other applicable securities laws, and unless so registered, the New Notes may not be offered, sold, pledged or otherwise transferred within the United States or to, or for the account or benefit of any U.S. persons (as defined in Regulation S under the U.S. Securities Act) except pursuant to an exemption from, or a transaction not subject to, the registration requirements of the U.S. Securities Act and any other applicable securities laws. The New Notes are being offered, sold and issued to (i) qualified institutional buyers in reliance on the exemption from the registration requirements of the U.S. Securities Act provided by Rule 144A or (ii) non-U.S. persons as defined in Rule 902 under the U.S. Securities Act in offshore transactions in reliance on Regulation S.

By purchasing the New Notes, you will be deemed to have represented and agreed as follows (terms used in this paragraph that are defined in Rule 144A or Regulation S under the U.S. Securities Act are used herein as defined therein):

- (1) You are not acting on behalf of the Issuers and you (A) (i) are a “qualified institutional buyer” (as defined in Rule 144A under the U.S. Securities Act), (ii) are aware that the sale to you is being made in reliance on Rule 144A; and (iii) are acquiring the New Notes for your own account or for the account of a qualified institutional buyer; or (B) are not a U.S. person (as defined in Regulation S under the U.S. Securities Act) (and are not purchasing the New Notes for the account or benefit of a U.S. person, other than a distributor) and are purchasing the New Notes in an offshore transaction pursuant to Regulation S.
- (2) You understand that the New Notes are being offered in a transaction not involving any public offering in the United States within the meaning of the U.S. Securities Act, that the New Notes have not been and will not be registered under the U.S. Securities Act or any other applicable securities laws and that (A) if in the future you decide to offer, resell, pledge or otherwise transfer any of the New Notes, such New Notes may be offered, resold, pledged or otherwise transferred only (i) for so long as the New Notes are eligible for resale under Rule 144A, in the United States to a person whom you reasonably believe is a qualified institutional buyer in a transaction meeting the requirements of Rule 144A; (ii) outside the United States in a transaction complying with the provisions of Regulation S under the U.S. Securities Act; (iii) pursuant to a registration statement that has been declared effective under the U.S. Securities Act; (iv) to the applicable Issuer; or (v) pursuant to another available exemption from the registration requirements of the U.S. Securities Act, subject to the applicable Issuer’s and Trustee’s right prior to any such offer, sale or transfer pursuant to this clause (v) to require the delivery of an opinion of counsel, certification and/or other information satisfactory to them, in each case in accordance with any applicable securities laws; and (B) you will, and each subsequent holder is required to, notify any subsequent purchaser of the New Notes from you or it of the resale restrictions referred to the legend below.
- (3) You acknowledge that none of us, the Initial Purchasers or any person representing us or the Initial Purchasers has made any representation to you with respect to us or the offer or sale of any of the New Notes, other than by us with respect to the information contained in these Listing Particulars, which Offering Memorandum has been delivered to you and upon which you are relying in making your investment decision with respect to the New Notes. You acknowledge that the Initial Purchasers make no representation or warranty as to the accuracy or completeness of these Listing Particulars. You have had access to such financial and other information concerning us and the New Notes as you deemed necessary in connection with your decision to purchase any of the New Notes, including an opportunity to ask questions of, and request information from, us and the Initial Purchasers.
- (4) You also acknowledge that:
 - (a) the Issuers and the Trustee reserve the right to require in connection with any offer, sale or other transfer of New Notes under the paragraph two above the delivery of an opinion of counsel, certifications and/or other information satisfactory to the Issuers and the Trustee; and
 - (b) each Global Note will contain a legend substantially to the following effect:

THIS NOTE HAS NOT BEEN REGISTERED UNDER THE U.S. SECURITIES ACT OF 1933, AS AMENDED (THE ‘U.S. SECURITIES ACT’), OR THE SECURITIES LAWS OF ANY STATE OR OTHER JURISDICTION. NEITHER THIS NOTE NOR ANY INTEREST OR PARTICIPATION HEREIN MAY BE REOFFERED, SOLD, ASSIGNED, TRANSFERRED, PLEDGED, ENCUMBERED OR OTHERWISE DISPOSED OF UNLESS SUCH TRANSACTION IS EXEMPT FROM, OR NOT SUBJECT TO, SUCH REGISTRATION.

THE HOLDER OF THIS NOTE BY ITS ACCEPTANCE HEREOF (1) REPRESENTS THAT (A) IT IS A "QUALIFIED INSTITUTIONAL BUYER" (AS DEFINED IN RULE 144A UNDER THE SECURITIES ACT) OR (B) IT IS NOT A U.S. PERSON AND IS ACQUIRING THIS NOTE IN AN "OFFSHORE TRANSACTION" PURSUANT TO RULE 904 OF REGULATION S UNDER THE U.S. SECURITIES ACT, (2) AGREES ON ITS OWN BEHALF AND ON BEHALF OF ANY INVESTOR ACCOUNT FOR WHICH IT HAS PURCHASED NOTES, TO OFFER, SELL OR OTHERWISE TRANSFER SUCH NOTES, PRIOR TO THE DATE (THE "RESALE RESTRICTION TERMINATION DATE") THAT IS [IN THE CASE OF RULE 144A NOTES: ONE YEAR] [IN THE CASE OF REGULATION S NOTES: 40 DAYS] AFTER THE LATER OF THE ORIGINAL ISSUE DATE HEREOF AND THE LAST DATE ON WHICH THE ISSUER OR ANY AFFILIATES OF THE ISSUER WAS THE OWNER OF THIS NOTE (OR ANY PREDECESSOR OF SUCH SECURITY), ONLY (A) TO THE ISSUER, (B) PURSUANT TO A REGISTRATION STATEMENT THAT HAS BEEN DECLARED EFFECTIVE UNDER THE U.S. SECURITIES ACT, (C) FOR SO LONG AS THE NOTES ARE ELIGIBLE FOR RESALE PURSUANT TO RULE 144A UNDER THE U.S. SECURITIES ACT, IN THE UNITED STATES TO A PERSON IT REASONABLY BELIEVES IS A "QUALIFIED INSTITUTIONAL BUYER" AS DEFINED IN RULE 144A UNDER THE U.S. SECURITIES ACT IN A TRANSACTION MEETING THE REQUIREMENTS OF RULE 144A, (D) OUTSIDE THE UNITED STATES IN A TRANSACTION COMPLYING WITH THE PROVISIONS OF REGULATION S UNDER THE U.S. SECURITIES ACT, OR (E) PURSUANT TO ANOTHER AVAILABLE EXEMPTION FROM THE REGISTRATION REQUIREMENTS OF THE U.S. SECURITIES ACT, SUBJECT TO THE ISSUER' AND THE TRUSTEE'S RIGHT PRIOR TO ANY SUCH OFFER, SALE OR TRANSFER PURSUANT TO CLAUSE (E) TO REQUIRE THE DELIVERY OF AN OPINION OF COUNSEL, CERTIFICATION AND/OR OTHER INFORMATION SATISFACTORY TO THEM. THIS LEGEND WILL BE REMOVED UPON THE REQUEST OF THE HOLDER AFTER THE RESALE RESTRICTION TERMINATION DATE.

BY ACCEPTING THIS NOTE (OR AN INTEREST IN THE NOTES REPRESENTED HEREBY) EACH ACQUIRER AND EACH TRANSFEREE IS DEEMED TO REPRESENT, WARRANT AND AGREE THAT AT THE TIME OF ITS ACQUISITION AND THROUGHOUT THE PERIOD THAT IT HOLDS THIS NOTE OR ANY INTEREST HEREIN (1) EITHER (A) IT IS NOT, AND IT IS NOT ACTING ON BEHALF OF (AND FOR SO LONG AS IT HOLDS SUCH NOTES OR ANY INTEREST THERE IN IT WILL NOT BE, AND WILL NOT BE ACTING ON BEHALF OF), AN EMPLOYEE BENEFIT PLAN (AS DEFINED IN SECTION 3(3) OF THE UNITED STATES EMPLOYEE RETIREMENT INCOME SECURITY ACT OF 1974, AS AMENDED ("ERISA")), SUBJECT TO THE PROVISIONS OF PART 4 OF SUBTITLE B OF TITLE I OF ERISA, A PLAN TO WHICH SECTION 4975 OF THE UNITED STATES INTERNAL REVENUE CODE OF 1986, AS AMENDED, ("CODE"), APPLIES, OR ANY ENTITY WHOSE UNDERLYING ASSETS INCLUDE "PLAN ASSETS" BY REASON OF SUCH AN EMPLOYEE BENEFIT PLAN'S OR PLAN'S INVESTMENT IN SUCH ENTITY (EACH, A "BENEFIT PLAN INVESTOR"), OR A GOVERNMENTAL, CHURCH OR NON-U.S. PLAN WHICH IS SUBJECT TO ANY FEDERAL, STATE, LOCAL, NON-U.S. OR OTHER LAWS OR REGULATIONS THAT ARE SUBSTANTIALLY SIMILAR TO THE FIDUCIARY RESPONSIBILITY OR THE PROHIBITED TRANSACTION PROVISIONS OF ERISA OR SECTION 4975 OF THE CODE ("SIMILAR LAWS"), AND NO PART OF THE ASSETS USED BY IT TO ACQUIRE OR HOLD THIS NOTE OR ANY INTEREST HEREIN CONSTITUTES THE ASSETS OF ANY BENEFIT PLAN INVESTOR OR SUCH A GOVERNMENTAL, CHURCH OR NON-U.S. PLAN, OR (B) ITS ACQUISITION, HOLDING AND DISPOSITION OF THIS NOTE OR AN INTEREST HEREIN DOES NOT AND WILL NOT CONSTITUTE OR OTHERWISE RESULT IN A NON-EXEMPT PROHIBITED TRANSACTION UNDER SECTION 406 OF ERISA OR SECTION 4975 OF THE CODE (OR, IN THE CASE OF A GOVERNMENTAL, CHURCH OR NON-U.S. PLAN, A NON-EXEMPT VIOLATION OF ANY SIMILAR LAWS); (2) NEITHER ISSUER NOR ANY OF ITS AFFILIATES IS A "FIDUCIARY" (WITHIN THE MEANING OF SECTION 3(21) OF ERISA OR, WITH RESPECT TO A GOVERNMENTAL, CHURCH OR NON-U.S. PLAN, ANY DEFINITION OF "FIDUCIARY" UNDER SIMILAR LAWS) WITH RESPECT TO THE PURCHASER OR HOLDER IN CONNECTION WITH ANY PURCHASE OR HOLDING OF THE NOTES, OR AS A RESULT OF ANY EXERCISE BY THE ISSUER OR ANY OF ITS AFFILIATES OF ANY RIGHTS IN CONNECTION WITH THE NOTES, AND NO ADVICE PROVIDED BY THE ISSUER OR ANY OF ITS AFFILIATES HAS FORMED A PRIMARY BASIS FOR ANY INVESTMENT DECISION BY OR ON BEHALF OF THE PURCHASER AND HOLDER IN CONNECTION WITH THE NOTES AND THE TRANSACTIONS CONTEMPLATED WITH RESPECT TO THE NOTES; AND (3) IT WILL NOT SELL OR OTHERWISE TRANSFER THIS NOTE OR ANY INTEREST HEREIN OTHER THAN TO A PURCHASER OR TRANSFEREE THAT IS DEEMED TO MAKE THESE SAME REPRESENTATIONS, WARRANTIES AND

AGREEMENTS WITH RESPECT TO ITS ACQUISITION, HOLDING AND DISPOSITION OF THIS NOTE.

- (c) The following legend shall also be included, if applicable:

THE FOLLOWING INFORMATION IS SUPPLIED SOLELY FOR U.S. FEDERAL INCOME TAX PURPOSES. THIS NOTE WAS ISSUED WITH “ORIGINAL ISSUE DISCOUNT” (“OID”) WITHIN THE MEANING OF SECTION 1273 OF THE INTERNAL REVENUE CODE OF 1986, AS AMENDED (THE “CODE”), AND THIS LEGEND IS REQUIRED BY SECTION 1275(c) OF THE CODE: U.S. HOLDERS MAY OBTAIN INFORMATION REGARDING THE AMOUNT OF OID, IF ANY, THE ISSUE PRICE, THE ISSUE DATE AND YIELD TO MATURITY BY CONTACTING THE ISSUERS, C/O ALTICE FINCO S.A., 3, BOULEVARD ROYAL, L-2449 LUXEMBOURG +352 278 58 901 ATTN: CHIEF FINANCIAL OFFICER.

If you purchase New Notes, you will also be deemed to acknowledge that the foregoing restrictions apply to holders of beneficial interests in these New Notes as well as to holders of these New Notes.

- (1) You acknowledge that the registrar will not be required to accept for registration of transfer any New Notes acquired by you, except upon presentation of evidence satisfactory to the Issuers and the registrar that the restrictions set forth herein have been complied with.
- (2) You acknowledge that:
- (a) The Issuers, the Initial Purchasers and others will rely upon the truth and accuracy of your acknowledgments, representations and agreements set forth herein and you agree that, if any of your acknowledgments, representations or agreements herein cease to be accurate and complete, you will notify the Issuers and the Initial Purchasers promptly in writing; and
- (b) if you are acquiring any New Notes as a fiduciary or agent for one or more investor accounts, you represent with respect to each such account that:
- (i) you have sole investment discretion; and
- (ii) you have full power to make, and make, the foregoing acknowledgments, representations and agreements.
- (3) You agree that you will give to each person to whom you transfer the New Notes notice of any restrictions on the transfer of the New Notes.
- (4) You acknowledge that the above restrictions on resale will apply from the closing date until the date that is one year (in the case of the New Notes issued under Rule 144A under the U.S. Securities Act) or 40 days (in the case of the New Notes issued under Regulation S under the U.S. Securities Act) after the later of the closing date and the last date that the applicable Issuer or any of its affiliates was the owner of the New Notes or any predecessor of the New Notes (the “*Resale Restriction Period*”), and will not apply after the applicable Resale Restriction Period ends.
- (5) The purchaser understands that no action has been taken in any jurisdiction (including the United States) by the Issuers or the Initial Purchasers that would permit a public offering of the New Notes or the possession, circulation or distribution of these Listing Particulars or any other material relating to the Issuers, the New Notes in any jurisdiction where action for the purpose is required. Consequently, any transfer of the New Notes will be subject to the selling restrictions set forth hereunder and/or in the front of these Listing Particulars under “*Notice to Certain European Investors*”, “*Notice to Israeli Investors*” and/or under “*Plan of Distribution*” or “*Certain Employee Benefit Plan Considerations*”.

TAX CONSIDERATIONS

EU Savings Directive

On June 3, 2003, the Council of the European Union adopted the European Council directive 2003/48/EC on the taxation of savings income in the form of interest payments (the “EU Savings Directive”). According to the EU Savings Directive, effective as from July 1, 2005, Member States are required to provide to the tax authorities of another Member State details of payment of interest or other similar income within the meaning of the EU Savings Directive made by a paying agent established within its jurisdiction to an individual resident or certain entities called “Residual Entities” (within the meaning of the EU Savings Directive) established in that other Member State or in a Territory (as defined below).

However, for a transitional period, Luxembourg is permitted to apply a withholding tax system whereby if a beneficial owner (within the meaning of the EU Savings Directive) does not opt for the exchange of information or does not provide specific tax certificate reporting, the relevant Member State will levy a withholding tax on payments to such beneficial owner. The rate of withholding is 35% since July 1, 2011. The transitional period is to terminate at the end of the first full fiscal year following the agreement by certain countries to the exchange of information in relation to such payments. The Luxembourg government has announced that it will elect out of the withholding tax system in favor of the automatic exchange of information with effect as of January 1, 2015.

Also with effect from July 1, 2005, a number of non-E.U. countries (Switzerland, Andorra, Liechtenstein, Monaco and San Marino) and certain dependent or associated territories (including Jersey, Guernsey, Isle of Man, Montserrat, British Virgin Islands, Curaçao, Saba, Sint Eustatius, Bonaire, St. Maarten, Aruba, Cayman Islands, Turks and Caicos Islands and Anguilla) (the “Territories”) have agreed to adopt similar measures (either provision of information or transitional withholding) in relation to payments made by a paying agent (within the meaning of the EU Savings Directive) within its jurisdiction to, or collected by such a paying agent for, an individual resident or a Residual Entity established in a Member State. In addition, Luxembourg has entered into reciprocal provision of information or transitional withholding arrangements with certain of those dependent or associated territories in relation to payments made by a paying agent (within the meaning of the EU Savings Directive) in Luxembourg to, or collected by such a paying agent for, an individual resident or a Residual Entity (within the meaning of the EU Savings Directive) established in one of those Territories.

Investors should note that the European Council formally adopted a Council Directive amending the EU Savings Directive on 24 March 2014 (the “Amending Directive”). The Amending Directive broadens the scope of the requirements described above. Member States have until January 1, 2017, to adopt the national legislation necessary to comply with the Amending Directive. The changes made under the Amending Directive include extending the scope of the EU Savings Directive to payments made to, or secured for, certain other entities and legal arrangements. They also broaden the definition of “interest payment” to cover income that is equivalent to interest.

Luxembourg Taxation

The following discussion summarizes certain important Luxembourg taxation principles that may be relevant to you if you invest in, own, hold or dispose of the Notes. Unless otherwise indicated, all information contained in this section is based on laws, regulations, practice and decision in effect in Luxembourg at the date of these Listing Particulars (as referred to herein, collectively, “*Luxembourg Tax Laws*”), and as such, may be superseded after such date. Any subsequent changes to Luxembourg Tax Laws could apply retroactively and could affect the continued accuracy of this summary. This summary does not purport to be a comprehensive description of all Luxembourg Tax Laws and Luxembourg tax considerations that may be relevant to a decision to invest in, own, hold, or dispose of the Notes and is not intended as tax advice to any particular investor or potential investor in the Notes. You should consult your own tax advisors about the tax consequences of investing in, owning, holding or disposing of the Notes (including with respect to receiving interest on and redeeming the Notes). This summary does not describe any tax consequences arising under the laws of any state, locality or other taxing jurisdiction other than Luxembourg.

The residence concept used below applies for Luxembourg income tax assessment purposes only. Any reference in the present section to a tax, duty, levy impost or other charge or withholding of a similar nature refers to Luxembourg Tax Laws and/or concepts only. Any reference to Luxembourg income tax encompasses corporate income tax (*impôt sur le revenu des collectivités*), municipal business tax (*impôt commercial communal*), a solidarity surcharge (*contribution au fonds pour l'emploi*), as well as personal income tax (*impôt sur le revenu*) generally. Corporate Noteholders may further be subject to net wealth tax (*impôt sur la fortune*) as well as other duties, levies or taxes. Corporate income tax, municipal business tax as well as the solidarity surcharge invariably apply to most corporate taxpayers resident of Luxembourg for tax purposes. Individual taxpayers are generally subject to personal income tax and the solidarity surcharge. Under certain circumstances, where an individual taxpayer acts in the course of the management of a professional or business undertaking, municipal business tax may apply as well.

Luxembourg tax residency of the Noteholders

A Luxembourg non-resident Noteholder will not become resident, nor be deemed to be resident, in Luxembourg by reason only of the holding of the Notes, or the execution, performance, delivery and/or enforcement of their entitlements thereunder.

Withholding Tax

In this section, “Interest”, “Residual Entities” and “Paying Agent” have the meaning given thereto in the Luxembourg laws of June 21, 2005 implementing the EU Savings Directive (or the relevant agreements). “Interest” will include accrued or capitalized interest at the sale, repayment or redemption of the Notes. “Residual Entities” include, in general, all entities established in the EU and certain Territories (as defined below) other than legal entities, UCITS, and entities taxed as enterprises. “Paying agent” is defined broadly for this purpose and, in the context of the Notes, means any economic entity established in Luxembourg which pays interest on the Notes to, or ascribes the payment of such interest to or for the immediate benefit of the beneficial owner or the Residual Entity whether the entity is, or acts on behalf of, the Issuers or is instructed by, the beneficial owner, or the Residual Entity, as the case may be, to collect such payment of interest.

Under Luxembourg income tax law currently applicable there is no withholding tax on the payment of interest, principal, premium or (to the extent the transaction is conducted on an arms-length basis) accrued but unpaid interest in respect of the Notes, nor is any Luxembourg withholding tax payable upon redemption or repurchase of the Notes, subject to the application of the Luxembourg law of December 23, 2005 according to which interest payments made by Luxembourg based paying agents (within the meaning of the EU Savings Directive) to Luxembourg individual residents or to certain foreign residual entities that secure interest payments on behalf of such individuals are subject to a 10% withholding tax. Such withholding tax will be in full discharge of income tax if the beneficial owner is an individual acting in the course of the management of his/her private wealth. The responsibility for the withholding tax will be assumed by the Luxembourg paying agent (within the meaning of the EU Savings Directive). A Luxembourg resident individual who acts in the course of the management of his or her private wealth and who is the beneficial owner of an interest payment made by a paying agent established outside Luxembourg in a member state of the European Union or of the European Economic Area or in a jurisdiction having concluded an agreement with Luxembourg in connection with the EU Savings Directive, may also to self-declare and pay for a final 10% levy. In such case, the 10% levy is calculated on the same amounts as for the payments made by Luxembourg resident paying agents. The option for the 10% levy must cover all interest payments made by the paying agent to the Luxembourg resident beneficial owner during the entire civil year.

In each case described here above, responsibility for the withholding tax will be assumed by the Luxembourg paying agent.

Other Withholding Taxes

If interest is paid by an entity that is not considered a Luxembourg entity, other withholding taxes could apply. A company that is considered an Israeli resident for tax purposes paying interest on a note denominated in a foreign currency to an individual who is a non-Israeli resident is required to withhold tax at a rate of 25%, except for interest paid to “material shareholders,” who are subject to tax according to their marginal tax rate (currently 48%). “Material shareholders” for these purposes are shareholders who hold directly or indirectly, including with others, at least 10% of any means of control in the company. Taxes to be withheld from interest paid to non-Israeli residents by an Israeli company may be reduced under an applicable tax treaty.

A company that is an Israeli resident for tax purposes paying interest on a similar note to a corporate entity will be subject to withholding tax in accordance with the applicable corporate tax rate for the year in which the interest is paid. The current corporate tax rate in Israel is 26.5%.

For purposes of the discussion above, payment by a company that is considered an Israeli resident for tax purposes of any principal amount of New Senior Notes that is treated as original issue discount for Israeli tax purposes would be subject to tax withholding provisions described above. The New Senior Note would generally be treated as having been issued with original issue discount if its principal amount exceeds its issue price.

Taxation of the Noteholders

Taxation of Luxembourg residents

Noteholders who are residents of Luxembourg, or non-resident Noteholders that have a permanent establishment, fixed place of business or a permanent representative in Luxembourg to which the Notes are attributable, must, for income tax

purposes, include any interest paid or accrued in their taxable income. Specific exemptions may be available for certain tax payers benefiting from a particular status.

Luxembourg resident individuals

A Luxembourg resident individual Noteholder acting in the course of the management of his/her private wealth, is subject to Luxembourg income tax at progressive rates in respect of interest received, redemption premiums or issue discounts under the Notes, except if a final withholding tax has been levied on such payments. See paragraph (b) of “—*Withholding Tax*”.

Luxembourg resident individual Noteholders acting in the course of the management of a professional or business undertaking to which the Notes are attributable, may have to include any interest received or accrued, as well as any gain realized on the sale or disposal of the Notes, in their taxable income for Luxembourg income tax assessment purposes (income tax levied at progressive rates). For Luxembourg resident individuals receiving interest as income from assets used in their professional capacity, the 10% withholding tax levied is credited against their final tax liability. The same tax treatment applies to non-resident Noteholders who have a permanent establishment or a permanent representative in Luxembourg to which the Notes are attributable.

Under Luxembourg domestic tax law, gains realized upon the disposal of the Notes by an individual Noteholder, who is a resident of Luxembourg for tax purposes and who acts in the course of the management of his/her private wealth, on the disposal of the Notes are not subject to Luxembourg income tax, provided the disposal takes place more than six months after the acquisition of the Notes.

An individual Noteholder, who acts in the course of the management of his/her private wealth and who is a resident of Luxembourg for tax purposes, has further to include the portion of the gains realized on the Notes corresponding to accrued but unpaid income in respect of the Notes in his/her taxable income, insofar as the accrued but unpaid interest is indicated separately in the agreement.

Gains realized upon a disposal of the Notes by an individual Noteholder acting in the course of the management of a professional or business undertaking and who is resident of Luxembourg for tax purposes are subject to Luxembourg income taxes.

Luxembourg corporate residents

Luxembourg corporate Noteholders must include any interest received or accrued, as well as any gain realized on the sale or disposal of the Notes, in their taxable income for Luxembourg income tax assessment purposes (corporate income tax and municipal business tax).

Luxembourg corporate residents benefiting from a special tax regime

Luxembourg corporate resident Noteholders that benefit from a special tax regime, such as, for example, (i) undertakings for collective investment subject to the amended law December 17, 2010, (ii) specialized investment funds subject to the law dated February 13, 2007 or (iii) family wealth management companies subject to the law dated May 11, 2007, are exempt from income tax in Luxembourg except for an annual subscription tax (*tax d'abonnement*) and thus income derived from the Notes, as well as gains realized thereon, are not subject to Luxembourg income taxes.

Taxation of non-resident Noteholders

Noteholders who are non-residents of Luxembourg and who have neither a permanent establishment, neither a fixed place of business, nor a permanent representative in Luxembourg to which the Notes are attributable are not liable to any Luxembourg income tax, whether they receive payments of principal or interest (including accrued but unpaid interest) or realize capital gains upon redemption, repurchase, sale or exchange of any Notes. Noteholders who are non-residents of Luxembourg and who have a permanent establishment, a fixed place of business or a permanent representative in Luxembourg to which the Notes are attributable have to include any interest received or accrued, as well as any capital gain realized on the sale or disposal of the Notes in their taxable income for Luxembourg income tax assessment purposes.

Net Wealth Tax

Individuals

An individual Noteholder, whether he/she is resident of Luxembourg or not, is not subject to Luxembourg wealth tax on such Notes.

Corporations

Corporate Luxembourg resident Noteholders or non-resident Noteholders which maintain a permanent establishment, fixed place of business or a permanent representative in Luxembourg to which the Notes or income thereon are attributable, are subject to an annual Luxembourg net wealth tax on such Notes levied at a rate of 0.5% of their value, except if the Noteholder is (i) an undertaking for collective investment subject to the amended law December 17, 2010, (ii) securitization vehicles governed by the law of March 22, 2004 on securitization (as amended), (iii) a specialized investment fund subject to the law of February 13, 2007 (as amended) or (iv) a family wealth management company subject to the law of May 11, 2007.

Other Taxes

Registration taxes and stamp duties

There is no Luxembourg registration tax, stamp duty or any other similar tax or duty payable in Luxembourg by the Noteholders as a consequence of the issuance of the Notes, nor will any of these taxes be payable as a consequence of a subsequent transfer, redemption or repurchase of the Notes. There is no obligation to register the Notes in Luxembourg. However, a registration duty may apply (i) upon voluntary registration of the Notes in Luxembourg, (ii) in the case of legal proceedings before Luxembourg courts or (iii) in the case that the documents relating to the Notes issuance must be produced before an official Luxembourg authority (“*autorité constituée*”).

Value added tax

There is no Luxembourg value added tax payable in respect of payments in consideration for the issuance of the Notes or in respect of the payment of interest or principal under the Notes or the transfer of the Notes. Luxembourg value added tax may, however, be payable in respect of fees charged for certain services rendered to the Issuers, if for Luxembourg value added tax purposes such services are rendered or are deemed to be rendered in Luxembourg and an exemption from Luxembourg value added tax does not apply with respect to such services. Due to the activity of the Issuers, this value-added tax could be a final cost. Foreign value-added tax that might be payable in respect of fees charged for certain services rendered to the Issuers could also be a final cost.

Inheritance tax and gift tax

No estate or inheritance taxes are levied on the transfer of the Notes upon death of a Noteholder in cases where the deceased was not a resident of Luxembourg at the time of his death for inheritance tax purposes.

Gift tax may be due on a gift or donation of Notes in instances where the gift is recorded in a deed passed in front of a Luxembourg notary or otherwise registered in Luxembourg.

Certain U.S. Federal Income Tax Considerations

The following is a description of certain U.S. federal income tax considerations of the acquisition, ownership, and disposition of the New Notes by a U.S. Holder thereof as defined below. This description only applies to New Notes held as capital assets and does not address, except as set forth below, aspects of U.S. federal income taxation that may be applicable to holders that are subject to special tax rules, such as:

- banks or other financial institutions;
- insurance companies;
- real estate investment trusts;
- regulated investment companies;
- grantor trusts;

- tax-exempt organizations;
- persons that will own the New Notes through partnerships or other pass-through entities;
- dealers or traders in securities or currencies;
- U.S. Holders that have a functional currency other than the U.S. dollar;
- certain former citizens and long-term residents of the United States;
- U.S. Holders that use a mark-to-market method of accounting; or
- U.S. Holders that will hold a New Note as part of a position in a straddle or as part of a hedging, conversion or integrated transaction for U.S. federal income tax purposes.

Moreover, this description does not address the 3.8% Medicare tax on net investment income, the U.S. federal estate and gift tax or the alternative minimum tax consequences of the acquisition, ownership, and disposition of the New Notes and does not address the U.S. federal income tax treatment of holders that do not acquire the New Notes as part of the initial distribution at their initial issue price (generally, in each case, the first price to the public at which a substantial amount of the Dollar Senior Secured Notes, the Euro Senior Secured Notes or the New Senior Notes, as applicable, is sold for money). Each prospective purchaser should consult its own tax advisor with respect to the U.S. federal, state, local and non-U.S. tax consequences of acquiring, owning and disposing of the New Notes.

This description is based on the Code, U.S. Treasury Regulations promulgated thereunder, administrative pronouncements and judicial decisions, each as available and in effect on the date hereof. All of the foregoing are subject to change or differing interpretations, possibly with retroactive effect, which could affect the tax consequences described herein. No opinion of counsel to the Issuers or the holders or ruling from the IRS has been or will be given with respect to any of the considerations discussed herein. No assurances can be given that the IRS would not assert, or that a court would not sustain, a position different from any of the tax considerations discussed below.

For purposes of this description, a U.S. Holder is a beneficial owner of the New Notes who for U.S. federal income tax purposes is:

- a citizen or individual resident of the United States;
- a corporation (or any other entity treated as a corporation for U.S. federal income tax purposes) organized in or under the laws of the United States or any State thereof, including the District of Columbia;
- an estate the income of which is subject to U.S. federal income taxation regardless of its source; or
- a trust (1) that validly elects to be treated as a U.S. person for U.S. federal income tax purposes or (2)(a) the administration over which a U.S. court can exercise primary supervision and (b) all of the substantial decisions of which one or more U.S. persons have the authority to control.

If an entity or arrangement treated as a partnership for U.S. federal income tax purposes holds the New Notes, the tax treatment of the partnership and a partner in such partnership generally will depend on the status of the partner and the activities of the partnership. Such partner or partnership should consult its own tax advisor as to its consequences.

Redemptions and Additional Amounts

In certain circumstances, the Issuers may be obligated to or may elect to make payments in excess of stated interest and the adjusted issue price of the New Notes and/or redeem the New Notes in advance of their stated maturity. The Issuers intend to take the position that the New Notes should not be treated as contingent payment debt instruments because of, among other things, the possibility of such payments. This position is based in part on assumptions, as of the date of issuance of the New Notes, (1) regarding the likelihood that such payments will have to be paid or that the Issuers will elect to pay such amounts and/or (2) relating to the expected yield to maturity of the New Notes. Assuming such position is respected, any such amounts paid to a U.S. Holder pursuant to any repurchase or redemption would be taxable as described below in “—*Sale, Exchange, Retirement or Other Disposition by a U.S. Holder*” and any payments of Additional Amounts in an amount in excess of stated interest and the adjusted issue price would be taxable as additional ordinary income when received or accrued, in accordance with such holder’s method of accounting for U.S. federal income tax purposes. An Issuer’s position is binding on a U.S. Holder unless such holder discloses its contrary position in the manner required by applicable U.S. Treasury Regulations. The IRS, however, may take a position contrary to the

Issuers' position, which could affect the timing and character of a U.S. Holder's income with respect to the New Notes. U.S. Holders should consult their own tax advisors regarding the potential application to the New Notes of the contingent payment debt instrument rules and the consequences thereof. This discussion assumes that the New Notes are not treated as contingent payment debt instruments.

U.S. Holders

Stated Interest

Stated interest on the New Notes (including Additional Amounts and any non-U.S. taxes withheld on payments of such stated interest or Additional Amounts) generally will be taxable to a U.S. Holder as ordinary interest income at the time it is received or accrued, depending on the U.S. Holder's method of accounting for U.S. federal income tax purposes.

Interest (including original issue discount ("OID"), if any, as described below) included in a U.S. Holder's gross income with respect to the New Notes will be treated as foreign source income for U.S. federal income tax purposes. The limitation on non-U.S. taxes eligible for the U.S. foreign tax credit is calculated separately with respect to specific "baskets" of income. For this purpose, interest generally should constitute "passive category income", or in the case of certain U.S. Holders, "general category income". U.S. Holders should consult their own tax advisors regarding the availability of foreign tax credits.

With respect to the Euro Senior Secured Notes, stated interest paid in euros will be included in a U.S. Holder's gross income in an amount equal to the U.S. dollar value of the euros, including the amount of any withholding tax thereon, regardless of whether the euros are converted into U.S. dollars. Generally, a U.S. Holder that uses the cash method of tax accounting will determine such U.S. dollar value using the spot rate of exchange on the date of receipt. A cash method U.S. Holder generally will not realize foreign currency gain or loss on the receipt of the interest payment but may have foreign currency gain or loss attributable to the actual disposition of the euros received. Generally, a U.S. Holder that uses the accrual method of tax accounting will determine the U.S. dollar value of accrued interest income using the average rate of exchange for the accrual period (or, with respect to an accrual period that spans two taxable years, at the average rate for the partial period within each taxable year). Alternatively, an accrual basis U.S. Holder may make an election (which must be applied consistently to all debt instruments from year to year and cannot be changed without the consent of the IRS) to translate accrued interest income at the spot rate of exchange on the last day of the accrual period (or the last day of the portion of the accrual period within each taxable year in the case of a partial accrual period) or the spot rate on the date of receipt, if that date is within five business days of the last day of the accrual period. A U.S. Holder that uses the accrual method of accounting for tax purposes will recognize foreign currency gain or loss on the receipt of an interest payment if the exchange rate in effect on the date the payment is received differs from the rate used in translating the accrual of that interest. The amount of foreign currency gain or loss to be recognized by such U.S. Holder will be an amount equal to the difference between the U.S. dollar value of the euro interest payment (determined on the basis of the spot rate on the date the interest income is received) in respect of the accrual period and the U.S. dollar value of the interest income that has accrued during the accrual period (as determined above) regardless of whether the payment is converted to U.S. dollars. This foreign currency gain or loss will be ordinary income or loss and generally will not be treated as an adjustment to interest income or expense. Foreign currency gain or loss generally will be U.S. source provided that the residence of a taxpayer is considered to be the United States for purposes of the rules regarding foreign currency gain or loss.

Original Issue Discount

The Dollar Senior Secured Notes, the Euro Senior Secured Notes or the New Senior Notes may be treated as issued with OID for U.S. federal income tax purposes. A New Note will be treated as having been issued with OID for U.S. federal income tax purposes if its stated principal amount exceeds its issue price by at least the "OID de minimis amount". The OID de minimis amount equals $\frac{1}{4}$ of 1% of the stated principal amount of the New Note multiplied by the number of complete years from its issue date to maturity.

If a New Note is issued with OID a U.S. Holder generally will be required to include OID in income before the receipt of the associated cash payment, regardless of the U.S. Holder's accounting method for tax purposes. The amount of OID with respect to a New Note that a U.S. Holder must include in income is the sum of the "daily portions" of the OID for the New Note for each day during the taxable year (or portion of the taxable year) in which the U.S. Holder held the New Note. The daily portion is determined by allocating a pro rata portion of the OID for each day of the accrual period. An accrual period may be of any length and the accrual periods may vary in length over the term of the New Note, provided that each accrual period is no longer than one year and each scheduled payment of principal or interest occurs either on the first day of an accrual period or on the final day of an accrual period. The amount of OID allocable to an accrual period is equal to the difference between (1) the product of the "adjusted issue price" of the New Note at the beginning of the accrual period and its yield to maturity (computed generally on a constant yield method and compounded at the end of each accrual period, taking into account the length of the particular accrual period) and (2) the amount of any stated

interest allocable to the accrual period. The “adjusted issue price” of a New Note at the beginning of any accrual period is the sum of the issue price of the New Note plus the amount of OID allocable to all prior accrual periods reduced by any payments on the New Note that were not stated interest.

Under these rules, a U.S. Holder generally will have to include in income increasingly greater amounts of OID in successive accrual periods. Under applicable U.S. Treasury Regulations, a U.S. Holder of a New Note with OID may elect to include in gross income all interest that accrues on the New Note using the constant yield method described above. Once made with respect to the New Note, the election cannot be revoked without the consent of the IRS. A U.S. Holder considering an election under these rules should consult its own tax advisor.

U.S. Holders may obtain information regarding the amount of OID, if any, the issue price, the issue date and yield to maturity by contacting the Issuers, c/o Altice Finco S.A., 3, Boulevard Royal, L-2449 Luxembourg +352 278 58 901 attn: Chief Financial Officer.

Any OID on a Euro Senior Secured Note or a Euro Senior Note generally will be determined for any accrual period in euros and then translated into U.S. dollars in the same manner as stated interest accrued by an accrual basis U.S. Holder. Upon receipt of an amount attributable to OID (whether in connection with the sale or disposition of such a New Note or otherwise), a U.S. Holder generally will recognize foreign currency gain or loss in an amount determined in the same manner as stated interest received on accrual basis, as described above. For these purposes, all receipts on a New Note will be viewed first, as payments of stated interest payable on the New Note; second, as receipts of previously accrued OID (to the extent thereof), with payments considered made for the earliest accrual periods first; and, third, as receipts of principals. Holders are urged to consult their own tax advisors regarding the interplay between the application of the OID and foreign currency exchange gain or loss rules.

The rules regarding OID are complex. U.S. Holders are urged to consult their own tax advisors regarding the application of these rules to their particular situations.

Sale, Exchange, Retirement or Other Disposition by a U.S. Holder

A U.S. Holder’s adjusted tax basis in a New Note generally will be its U.S. dollar cost increased by the amount of any OID previously included in income and decreased by payments other than stated interest made with respect to the New Note.

A U.S. Holder generally will recognize capital gain or loss on the sale, exchange, redemption, retirement or other taxable disposition of a New Note equal to the difference, if any, between the amount realized on the sale, exchange, retirement or other disposition of the New Note (less any amounts attributable to accrued but unpaid interest, which will be subject to tax in the manner described above under “—*Stated Interest*” to the extent not previously so taxed), and the U.S. Holder’s adjusted tax basis in the New Note. If a U.S. Holder purchases a Euro Senior Secured Note or a Euro Senior Note with euros, the U.S. dollar cost of the Euro Senior Secured Note or the Euro Senior Note, as applicable, generally will be the U.S. dollar value of the purchase price on the date of purchase calculated at the spot rate of exchange on that date. The amount realized upon the disposition of a Euro Senior Secured Note or a Euro Senior Note, as applicable, generally will be the U.S. dollar value of the amount received on the date of the disposition calculated at the spot rate of exchange on that date. However, if the Euro Senior Secured Note or the Euro Senior Note, as applicable, is traded on an established securities market, a cash basis U.S. Holder (and, if it so elects, an accrual basis U.S. Holder) should determine the U.S. dollar value of the cost of or amount received on the Euro Senior Secured Note or the Euro Senior Note, as applicable, by translating the amount paid or received at the spot rate of exchange on the settlement date of the purchase or disposition, as applicable. The election available to accrual basis U.S. Holders in respect of the purchase and disposition of Euro Senior Secured Notes, traded on an established securities market must be applied consistently to all debt instruments from year to year and cannot be changed without the consent of the IRS.

Subject to the foreign currency rules discussed below, any gain or loss recognized on the sale, exchange, retirement, or other disposition of a New Note will be capital gain or loss, and will be long-term capital gain or loss if the U.S. Holder has held the New Note for more than one year as of the date of disposition. Long-term capital gain of a non-corporate U.S. Holder is generally taxed at preferential rates. The ability of a U.S. Holder to offset capital losses against ordinary income is limited. Any gain or loss recognized on the sale, exchange, retirement or other disposition of a New Note generally will be treated as income from sources within the United States or loss allocable to income from sources within the United States.

Gain or loss recognized by a U.S. Holder on the sale, exchange, retirement or other disposition of a Euro Senior Secured Note or a Euro Senior Note, as applicable, generally will be treated as ordinary income or loss to the extent that the gain or loss is attributable to changes in foreign currency exchange rates during the period in which the U.S. Holder held such Euro Senior Secured Note or Euro Senior Note, as applicable. Such foreign currency gain or loss will equal the difference between (i) the U.S. dollar value of the U.S. Holder’s euro purchase price for the Euro Senior Secured Note or the Euro

Senior Note, as applicable, calculated at the spot rate of exchange on the date of the sale, exchange, retirement or other disposition and (ii) the U.S. dollar value of the U.S. Holder's euro purchase price for the Euro Senior Secured Note or the Euro Senior Note, as applicable, calculated at the spot rate of exchange on the date of purchase of the Euro Senior Secured Note or the Euro Senior Note, as applicable. If the Euro Senior Secured Note or the Euro Senior Note, as applicable, is traded on an established securities market, with respect to a cash basis U.S. Holder (and, if it so elects, an accrual basis U.S. Holder), such foreign currency gain or loss will equal the difference between (x) the U.S. dollar value of the U.S. Holder's euro purchase price for the Euro Senior Secured Note or the Euro Senior Note, as applicable, calculated at the spot rate of exchange on the settlement date of the disposition and (y) the U.S. dollar value of the U.S. Holder's euro purchase price for the Euro Senior Secured Note or the Euro Senior Note, as applicable, calculated at the spot rate of exchange on the settlement date of the purchase of the Euro Senior Secured Note or the Euro Senior Note, as applicable. The realization of any foreign currency gain or loss, including foreign currency gain or loss with respect to amounts attributable to accrued and unpaid stated interest and any OID, will be limited to the amount of overall gain or loss realized on the disposition of the Euro Senior Secured Notes or the Euro Senior Note, as applicable.

Exchange of Amounts in Other than U.S. Dollars

If a U.S. Holder receives euros as interest on a Euro Senior Secured Note or a Euro Senior Note or on the sale, exchange, retirement or other disposition of a Euro Senior Secured Note or a Euro Senior Note, such U.S. Holder's tax basis in such euros will equal the U.S. dollar value of such euros when the interest is received or at the time of the sale, exchange, retirement or other disposition. If a U.S. Holder purchased a Euro Senior Secured Note or a Euro Senior Note with previously owned non-U.S. currency, gain or loss will be recognized in an amount equal to the difference, if any, between the U.S. Holder's tax basis in such currency and the spot rate on the date of purchase. Any such gain or loss generally will be treated as ordinary income or loss from sources within the United States provided that the residence of the U.S. Holder is considered to be the United States for purposes of the rules governing foreign currency transactions.

Reportable Transaction Reporting

Under certain U.S. Treasury Regulations, U.S. Holders that participate in "reportable transactions" (as defined in the regulations) must attach to their U.S. federal income tax returns a disclosure statement on IRS Form 8886. Under the relevant rules, a U.S. Holder may be required to treat a foreign currency exchange loss from the Euro Senior Secured Notes as a reportable transaction if this loss exceeds the relevant threshold in the regulations. U.S. Holders should consult their own tax advisors as to the possible obligation to file IRS Form 8886 with respect to the ownership or disposition of the Euro Senior Secured Notes, or any related transaction, including without limitation, the disposition of any non-U.S. currency received as interest or as proceeds from the sale, exchange, retirement or other disposition of the Euro Senior Secured Notes.

U.S. Backup Withholding Tax and Information Reporting

Backup withholding and information reporting requirements may apply to certain payments of principal of, and interest (including accruals of OID, if any) on, and to proceeds from the sale, exchange, retirement or disposition of New Notes that are held by U.S. Holders. The payor will be required to withhold backup withholding tax on payments made within the United States, or by a U.S. payor or U.S. middleman (and certain subsidiaries thereof), on a New Note to a U.S. Holder, other than an exempt recipient, if the holder fails to furnish its correct taxpayer identification number or otherwise fails to comply with, or establish an exemption from, the backup withholding requirements. Payments within the United States, or by a U.S. payor or U.S. middleman (and certain subsidiaries thereof), of principal and interest (including OID, if any) and proceeds of a sale, exchange, retirement or disposition to a holder of a New Note that is not a U.S. person generally are subject to information reporting, but will not be subject to backup withholding tax if an appropriate certification is timely provided by the holder to the payor and the payor does not have actual knowledge or a reason to know that the certificate is incorrect.

Backup withholding is not an additional tax. Amounts withheld as backup withholding may be credited against a holder's U.S. federal income tax liability. A holder may obtain a refund of any excess amounts withheld under the backup withholding rules by filing the appropriate claim for a refund with the IRS and furnishing any required information in a timely manner.

Certain U.S. Holders are required to report information relating to an interest in the New Notes, subject to certain exceptions (including an exception for New Notes held in custodial accounts maintained by certain financial institutions). U.S. Holders are urged to consult their own tax advisors regarding the effect, if any, of this requirement on their ownership and disposition of the New Notes.

FATCA

Legislation referred to as the Foreign Account Tax Compliance Act (“FATCA”) generally may impose withholding at a rate of 30% on payments made to any foreign entity (whether such foreign entity is a beneficial owner or an intermediary) on debt obligations generating U.S. source interest or certain other debt obligations generating non-U.S. source interest issued by a foreign financial institution that (i) enters into certain agreements with the IRS or (ii) becomes subject to provisions of local law intended to implement an intergovernmental agreement entered into pursuant to FATCA, in each case to the extent such payments are attributable to U.S. source income, unless the foreign entity receiving such payments complies with various U.S. information reporting and/or due diligence requirements (generally relating to ownership by U.S. persons of interests in or accounts with such foreign entity) or otherwise qualifies for an exemption. Based on current guidance, the Issuers do not expect payments on the New Notes to be subject to the withholding tax rules under FATCA; however, if the New Notes are “materially modified” (within the meaning of applicable U.S. Treasury Regulations) after the date that is six months after the date final regulations define a “foreign passthru payment” under FATCA, certain “foreign passthru payments” made on the New Notes on or after January 1, 2017 may become subject to the withholding tax rules under FATCA. If such withholding is required under FATCA, holders and beneficial owners of the New Notes will not be entitled to receive any additional amounts to compensate them for such withholding. Non-U.S. governments have entered into agreements with the United States (and additional non-U.S. governments are expected to enter into such agreements) to implement FATCA in a manner that alters the rules described herein. Holders should consult their own tax advisors regarding the possible implications of this legislation on their investment in the New Notes.

The above description is not intended to constitute a complete analysis of all tax consequences relating to the acquisition, ownership and disposition of the New Notes. Prospective purchasers of the New Notes should consult their own tax advisors concerning the tax consequences of their particular situations.

CERTAIN EMPLOYEE BENEFIT PLAN CONSIDERATIONS

The U.S. Employee Retirement Income Security Act of 1974, as amended (“ERISA”), imposes certain fiduciary standards and certain other requirements on employee benefit plans subject to ERISA, including entities such as collective investment funds, certain insurance company separate accounts, certain insurance company general accounts, and entities whose underlying assets are treated as being subject to ERISA (collectively, “ERISA Plans”), and on those persons who are fiduciaries with respect to ERISA Plans. Investments by ERISA Plans are subject to ERISA’s general fiduciary requirements, including the requirement of investment prudence and diversification and the requirement that an ERISA Plan’s investments be made in accordance with the documents governing the ERISA Plan. The prudence of a particular investment should be determined by the responsible fiduciary of an ERISA Plan by taking into account the ERISA Plan’s particular circumstances and all of the facts and circumstances of the investment, including, but not limited to, the matters discussed above under “*Risk Factors*” and the fact that in the future there may be no market in which such fiduciary will be able to sell or otherwise dispose of the New Notes or any interest therein.

Section 406 of ERISA and Section 4975 of the U.S. Internal Revenue Code of 1986, as amended (the “Code”), prohibit certain transactions involving the assets of an ERISA Plan, as well as those plans that are not subject to ERISA but which are subject to Section 4975 of the Code, such as individual retirement accounts and Keogh plans (together with ERISA Plans, “Plans”), and certain persons (referred to as “parties in interest” under ERISA or “disqualified persons” under the Code) having certain relationships to Plans, unless a statutory or administrative exemption is applicable to the transaction. A party in interest or disqualified person who engages in a prohibited transaction may be subject to excise taxes or other liabilities under ERISA and the Code, and the transaction may have to be rescinded.

Governmental plans, certain church plans and certain non-U.S. plans, while not subject to the fiduciary responsibility or prohibited transaction provisions of ERISA or the provisions of Section 4975 of the Code, may nevertheless be subject to federal, state, local, non-U.S. or other laws or regulations (such as the prohibited transaction rules of Section 503 of the Code) that are substantially similar to the foregoing provisions of ERISA or the Code (“Similar Laws”).

Each of us, the Initial Purchasers, the Trustee and certain other parties, or their respective affiliates, may be the sponsor of, or Fiduciary to, one or more Plans. Because such parties may receive certain benefits in connection with the sale of the New Notes to such Plans, the purchase of such New Notes using the assets of a Plan over which any of such parties is the sponsor or a Fiduciary might be deemed to be a violation of the prohibited transaction rules of ERISA or Section 4975 of the Code for which no exemption may be available. Accordingly, the New Notes may not be purchased using the assets of any Plan if any of us, the Initial Purchasers, the Trustee or their respective affiliates is the sponsor of or Fiduciary to, such Plan.

In addition, if the New Notes are acquired by a Plan with respect to which we, the Initial Purchasers, the Trustee, any holder of the New Notes or any of their respective affiliates is a party in interest or a disqualified person, other than a sponsor of, or Fiduciary to, such Plan, such transaction could be deemed to be a direct or indirect prohibited transaction within the meaning of Section 406 of ERISA or Section 4975 of the Code. In addition, if a party in interest or disqualified person with respect to a Plan owns or acquires a 50% or more beneficial interest in the Issuers, the acquisition or holding of the New Notes by or on behalf of such Plan could be considered to constitute a prohibited transaction. Moreover, the acquisition or holding of the New Notes or other indebtedness issued by the Issuers by or on behalf of a party in interest or disqualified person with respect to a Plan that owns or acquires an equity interest in the Issuers also could give rise to a prohibited transaction. Certain exemptions from the prohibited transaction provisions of ERISA and Section 4975 of the Code could be applicable, however, to a Plan’s acquisition of a Note depending in part upon the type of Fiduciary making the decision to acquire a Note and the circumstances under which such decision is made. Included among these exemptions are Prohibited Transaction Exemption (“PTE”) 84-14, regarding transactions effected by a “qualified professional asset manager”; PTE 90-1, regarding investments by insurance company pooled separate accounts; PTE 91-38, regarding investments by bank collective investment funds; PTE 95-60, regarding investments by insurance company general accounts and PTE 96-23, regarding investments by certain “in-house asset managers;”. In addition to the class exemptions listed above, Section 408(b)(17) of ERISA and Section 4975(d)(20) of the Code provide a statutory prohibited transaction exemption for transactions between a Plan and a person or entity that is a party in interest to such Plan solely by reason of providing services to the Plan (other than a party in interest that is a fiduciary, or its affiliate, that has or exercises discretionary authority or control or renders investment advice with respect to the assets of the Plan involved in the transaction), provided that the Plan receives no less, and pays no more than “adequate consideration” (within the meaning of Section 408(b)(17) of ERISA and Section 4975(f)(10) of the Code) in connection with the transaction. Even if the conditions specified in one or more of these exemptions are met, the scope of the relief provided by these exemptions might not cover all acts which might be construed as prohibited transactions.

EACH ACQUIRER AND EACH TRANSFEREE OF A NEW NOTE OR ANY INTEREST THEREIN WILL BE DEEMED TO REPRESENT, WARRANT AND AGREE AT THE TIME OF ITS ACQUISITION AND THROUGHOUT THE PERIOD THAT IT HOLDS SUCH NEW NOTES OR ANY INTEREST THEREIN, THAT (1) EITHER (A) IT IS NOT, AND IS NOT ACTING ON BEHALF OF, A BENEFIT PLAN INVESTOR OR A

GOVERNMENTAL, CHURCH OR NON-U.S. PLAN WHICH IS SUBJECT TO ANY SIMILAR LAWS, AND NO PART OF THE ASSETS TO BE USED BY IT TO ACQUIRE OR HOLD SUCH NEW NOTES OR ANY INTEREST THEREIN CONSTITUTES THE ASSETS OF ANY BENEFIT PLAN INVESTOR OR SUCH A GOVERNMENTAL, CHURCH OR NON-U.S. PLAN, OR (B) ITS ACQUISITION, HOLDING AND DISPOSITION OF SUCH NEW NOTES OR ANY INTEREST THEREIN DOES NOT AND WILL NOT CONSTITUTE OR OTHERWISE RESULT IN A NON-EXEMPT PROHIBITED TRANSACTION UNDER SECTION 406 OF ERISA OR SECTION 4975 OF THE CODE (OR, IN THE CASE OF A GOVERNMENTAL, CHURCH, OR NON-U.S. PLAN, A NON-EXEMPT VIOLATION OF ANY SIMILAR LAWS); AND (2) NEITHER THE ISSUER NOR ANY OF ITS AFFILIATES IS A FIDUCIARY (WITHIN THE MEANING OF SECTION 3(21) OF ERISA OR, WITH RESPECT TO A GOVERNMENTAL, CHURCH OR NON-U.S. PLAN, ANY DEFINITION OF "FIDUCIARY" UNDER SIMILAR LAWS) WITH RESPECT TO THE PURCHASER OR HOLDER IN CONNECTION WITH ANY PURCHASE OR HOLDING OF THE NEW NOTES, OR AS A RESULT OF ANY EXERCISE BY THE NOTES ISSUER OR ANY OF ITS AFFILIATES OF ANY RIGHTS IN CONNECTION WITH THE NEW NOTES, AND NO ADVICE PROVIDED BY THE ISSUER OR ANY OF ITS AFFILIATES HAS FORMED A PRIMARY BASIS FOR ANY INVESTMENT DECISION BY OR ON BEHALF OF THE PURCHASER AND HOLDER IN CONNECTION WITH THE NEW NOTES AND THE TRANSACTIONS CONTEMPLATED WITH RESPECT TO THE NEW NOTES; AND (3) IT WILL NOT SELL OR OTHERWISE TRANSFER SUCH NEW NOTES OR ANY INTEREST THEREIN OTHER THAN TO AN ACQUIRER OR TRANSFEREE THAT IS DEEMED TO MAKE THESE SAME REPRESENTATIONS, WARRANTIES AND AGREEMENTS WITH RESPECT TO ITS ACQUISITION, HOLDING AND DISPOSITION OF SUCH NEW NOTE.

WE, THE INITIAL PURCHASERS AND THE TRUSTEE, AND THEIR RESPECTIVE AFFILIATES, SHALL BE ENTITLED TO CONCLUSIVELY RELY UPON THE TRUTH AND ACCURACY OF THE FOREGOING REPRESENTATIONS, WARRANTIES AND AGREEMENTS BY ACQUIRERS AND TRANSFEREES OF ANY NEW NOTES WITHOUT FURTHER INQUIRY. THE ACQUIRER AND ANY FIDUCIARY CAUSING IT TO ACQUIRE AN INTEREST IN ANY NEW NOTES AGREES TO INDEMNIFY AND HOLD HARMLESS THE ISSUER, THE INITIAL PURCHASERS AND THE TRUSTEE, AND THEIR RESPECTIVE AFFILIATES, FROM AND AGAINST ANY COST, DAMAGE OR LOSS INCURRED BY ANY OF THEM AS A RESULT OF ANY OF THE FOREGOING REPRESENTATIONS AND AGREEMENTS BEING OR BECOMING FALSE.

ANY PURPORTED ACQUISITION OR TRANSFER OF ANY NEW NOTE OR BENEFICIAL INTEREST THEREIN TO AN ACQUIRER OR TRANSFEREE THAT DOES NOT COMPLY WITH THE REQUIREMENTS DESCRIBED HEREIN SHALL BE NULL AND VOID *AB INITIO*.

It should be noted that an insurance company's general account may be deemed to include assets of Plans under certain circumstances, e.g. where a Plan purchases an annuity contract issued by such an insurance company, based on the reasoning of the United States Supreme Court in *John Hancock Mutual Life Ins. Co. v. Harris Trust and Savings Bank*, 510 U.S. 86 (1993). An insurance company considering the purchase of New Notes with assets of its general account should consider such purchase and the insurance company's ability to make the representations described above in light of *John Hancock Mutual Life Ins. Co. v. Harris Trust and Savings Bank*, Section 401(c) of ERISA and the U.S. Department of Labor regulation at 29 C.F.R. Section 2550.401c-1.

A fiduciary of an ERISA Plan or other employee benefit plan that is subject to Similar Laws, prior to investing in the New Notes or any interest therein, should take into account, among other considerations, whether the fiduciary has the authority to make the investment; the composition of the plan's portfolio with respect to diversification by type of asset; the plan's funding objectives; the tax effects of the investment; and whether, under the general fiduciary standards of ERISA or other applicable laws, including investment prudence and diversification, an investment in the New Notes or any interest therein is appropriate for the plan, taking into account the plan's particular circumstances and all of the facts and circumstances of the investment, including such matters as the overall investment policy of the plan and the composition of the plan's investment portfolio.

The sale of any New Note or any interest therein to a Plan or a governmental, church or non-U.S. plan that is subject to any Similar Laws is in no respect a representation by us, the Initial Purchasers or the Trustee, or any of their respective affiliates, that such an investment meets all relevant legal requirements with respect to investments by such plans generally or any particular such plan; that the prohibited transaction exemptions described above, or any other prohibited transaction exemption, would apply to such an investment by such plan in general or any particular such plan; or that such an investment is appropriate for such plan generally or any particular such plan.

The discussion of ERISA and Section 4975 of the Code contained in these Listing Particulars, is, of necessity, general, and does not purport to be complete. Moreover, the provisions of ERISA and Section 4975 of the Code are subject to extensive and continuing administrative and judicial interpretation and review. Therefore, the matters discussed above may be affected by future regulations, rulings and court decisions, some of which may have retroactive application and effect.

Any Plan or employee benefit plan not subject to ERISA or Section 4975 of the Code, and any fiduciary thereof, proposing to invest in the New Notes or any interest therein should consult with its legal advisors regarding the applicability of the fiduciary responsibility and prohibited transaction provisions of ERISA, Section 4975 of the Code and any Similar Laws, to such investment, and to confirm that such investment will not constitute or result in a non-exempt prohibited transaction or any other violation of any applicable requirement of ERISA, Section 4975 of the Code or Similar Laws.

CORPORATE AND FINANCING STRUCTURE

The following diagram summarizes our expected corporate and financing structure after giving effect to the New Transactions, including the offering of the New Notes and the application of the proceeds therefrom as described in “*The Transactions*”, “*Use of Proceeds*” and “*General Description of our Business and the Offering—Recent Developments*.” The following is provided for indicative and illustration purposes only and should be read in conjunction with the information contained elsewhere in these Listing Particulars. For a summary of the debt obligations referred to in the following diagram, see “*Description of Senior Secured Notes*”, “*Description of Senior Notes*” and “*Description of Other Indebtedness*”.

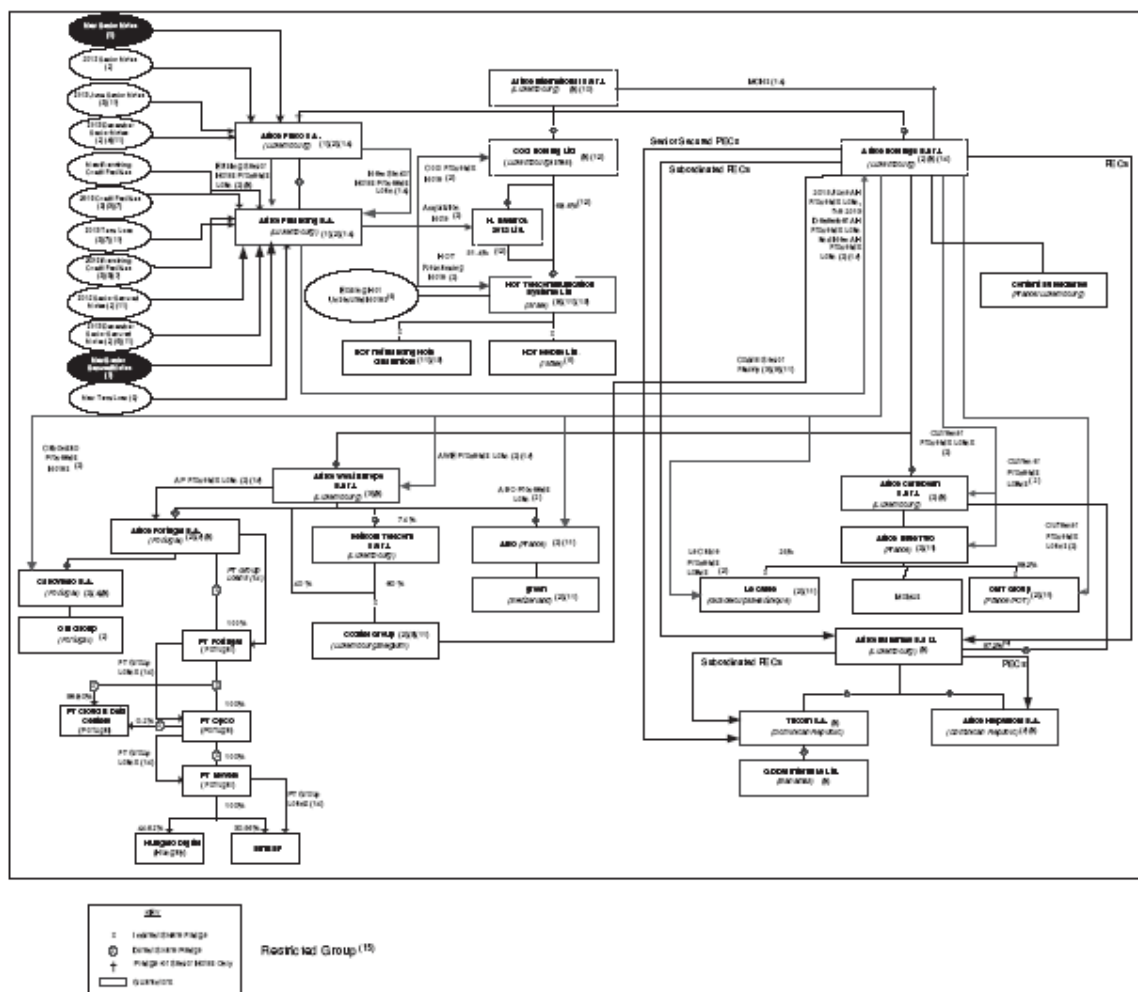

* Unless otherwise stated, the Group's shareholding is approximately 100%.

* This chart is a condensed summary of the corporate and financing structure of the Group and does not show each legal entity within the Group.

- (1) In connection with the New Transactions, the Senior Notes Issuer issued the New Senior Notes (\$385 million) and the Senior Secured Notes Issuer (i) issued the New Senior Secured Notes (€2,317 million equivalent), (ii) entered into the New Super Senior Revolving Credit Facility and (iii) entered into the New Term Loan (€841 million equivalent). The Initial Purchasers (i) deposited the gross proceeds from the offering of the New Senior Notes into a segregated escrow account for the benefit of the holders of the New Senior Notes and (ii) deposited the gross proceeds from the offering of the New Senior Secured Notes into segregated escrow accounts for the benefit of the respective holders of the New Senior Secured Notes. See “*The Transactions—The Financing*”. The New Senior Secured Notes and the New Senior Notes will be released from escrow upon satisfaction of the conditions to the release of the escrow proceeds as set forth in “*Description of Senior Secured Notes—Escrow of Proceeds; Special Mandatory Redemption*” and “*Description of Senior Notes—Escrow of Proceeds; Special Mandatory Redemption*”.

The New Senior Secured Notes and the New Super Senior Revolving Credit Facility are senior secured obligations of the Senior Secured Notes Issuer and the New Senior Notes are senior obligations of the Senior Notes Issuer. Prior to the release of all of the proceeds of the offering of the New Senior Secured Notes and the New Senior Notes (as applicable) from the applicable escrow accounts, the New Senior Secured Notes are secured by a first ranking pledge over the Senior Secured Notes Issuer's rights under the Senior Secured Notes Escrow Agreement and the assets in the Senior Secured Notes Escrow Accounts and the New Senior Notes are secured by a first ranking pledge over the Senior Notes Issuer's rights under the Senior Notes Escrow Agreement and the assets in the Senior Notes Escrow Account.

- (2) In connection with the 2012 Transaction, (i) the Senior Secured Notes Issuer issued the 2012 Senior Secured Notes and entered into the 2012 Revolving Credit Facility and (ii) the Senior Notes Issuer issued the 2012 Senior Notes. The Senior Notes Issuer made an intercompany loan of the gross proceeds of the offering of the 2012 Senior Notes (the “2012 Senior Notes Proceeds Loan”) to the Senior Secured Notes Issuer, which in turn used amounts borrowed under the 2012 Senior Notes Proceeds Loan and the proceeds under the 2012 Senior Secured Notes to purchase the Cool Proceeds Note, the 2012 Acquisition Note, the HOT Refinancing Note and to pay certain fees and expenses incurred in connection with the 2012 Transaction and for general corporate purposes.

In connection with the 2013 June Transactions, (i) the Senior Secured Notes Issuer entered into the 2013 Term Loan, the 2013 Revolving Credit Facility and the 2013 Guarantee Facility (together, the “2013 Credit Facilities”), and (ii) the Senior Notes Issuer issued the 2013 June Senior Notes. The Senior Notes Issuer made an intercompany loan of the gross proceeds of the offering of the 2013 June Senior Notes (the “2013 June Senior Notes Proceeds Loan”) to the Senior Secured Notes Issuer, which in turn used amounts borrowed under the 2013 June Senior Notes Proceeds Loan, the proceeds drawn under the 2013 Term Loan and cash on hand to make an aggregate €933 million proceeds loan (the “2013 June AH Proceeds Loan”) to Altice Holdings. Altice Holdings used the 2013 June AH Proceeds Loan as follows:

- (i) to purchase bonds issued by Cabovisão in an amount of €22.2 million (together with the Original Cabovisão Proceeds Notes, the “Cabovisão Proceeds Notes”), the proceeds of which were used by Cabovisão to consummate the ONI Acquisition;
- (ii) to consummate the ONI Refinancing, in connection with which Altice Holdings subscribed bonds issued by Onitecom in an amount of €47.5 million (the “Onitecom Proceeds Notes”) and (ii) the ONI Security was assigned to secure the Senior Secured Debt (other than the 2013 December Senior Secured Notes and the New Senior Secured Notes) up to an amount equal to the Aggregate Portuguese Security and Guarantee Limit;
- (iii) to consummate the Coditel Refinancing;
- (iv) in connection with the Outremer Transaction, to make (A) a €78 million intercompany loan to Altice Caribbean (which was used to subscribe to convertible bonds issued by Altice Blue Two (the “ABT Convertible Bonds”), (B) a €101 million intercompany loan to Altice Blue Two; (C) a €151 million intercompany loan to OMT Invest (out of which OMT Invest made a €26 million intercompany loan to Groupe Outremer Telecom (the “GOT On-Loan”), and (D) a €25 million intercompany loan to Outremer Telecom (collectively, but excluding the ABT Convertible Bonds and the GOT On-Loan, the “Outremer Proceeds Loans”);
- (v) to make a €8 million intercompany loan to Le Cable Martinique and a €14 million intercompany loan to Le Cable Guadeloupe (collectively, the “Le Cable Proceeds Loans”) to consummate the Le Cable Refinancing;
- (vi) to make a €48 million intercompany loan to ABO (the “ABO Proceeds Loan”) to consummate the ABO Refinancing;
- (vii) to consummate the Cabovisão Refinancing, in connection with which the collateral securing the Refinanced Cabovisão Bridge Facility was assigned to secure the Senior Secured Debt (other than the 2013 December Senior Secured Notes and the New Senior Secured Notes); and
- (viii) to subscribe to preferred equity certificates and a stapled interest free loan in an amount of approximately €85 million issued by Altice West Europe which was used to consummate the 2013 Coditel Acquisition.

The New AH Proceeds Loan, the AWE Proceeds Loan (each as defined in note 14 below), the 2013 December AH Proceeds Loan, the 2013 June AH Proceeds Loan, the Cool Proceeds Note, the 2012 Acquisition Note and the HOT Refinancing Notes are referred to collectively as the “Senior Secured Notes Issuer Pledged Proceeds Notes”. The ABO Proceeds Loan, the Cabovisão Proceeds Notes, the Outremer Proceeds Loans, the Le Cable Proceeds Loans, the Onitecom Proceeds Notes and the Altice West Europe Proceeds Loan are referred to collectively as the “Covenant Party Pledged Proceeds Loans”. The Covenant Party Pledged Proceeds Loans and the Senior Secured Notes Issuer Pledged Proceeds Notes are referred to collectively as the “Pledged Proceeds Notes”.

- (3) On the release of the proceeds of the offering of the New Senior Secured Notes from the escrow accounts, the New Senior Secured Notes will be guaranteed (the “Senior Secured Note Guarantees”) by Altice International, Cool Holding, SPV1, Altice Holdings, Altice West Europe, Altice Caribbean, Green, Altice Portugal, Cabovisão, Altice Bahamas, Tricom S.A., Global Interlink Ltd., ODO, Winreason, ONI S.G.P.S., Onitecom, Knewon (the “Existing Guarantors”) and, within 90 days of the PT Portugal Acquisition, PT Portugal and PT OpCo (up to an amount equal to the applicable Aggregate Portuguese Security and Guarantee Limit) (and in respect of the 2012 Senior Secured Notes only, ABO) (the “Senior Secured Guarantors”). We expect to effect a merger between ABO and Altice West Europe in the near term and the New Senior Secured Notes will benefit from guarantees provided by the surviving entity of the merger. Following the release of the proceeds of the offering of the New Senior Secured Notes from the escrow accounts, the New Senior Secured Notes, together with the New Revolving Credit Facilities, the New Term Loan, the Existing Senior Secured Notes, the 2013 Term Loan, the 2012 Revolving Credit Facility, the 2013 Revolving Credit Facility and the 2013 Guarantee Facility (collectively, the “Senior Secured Debt”) and the Senior Secured Note Guarantees, together with the guarantees of the other Senior Secured Debt by the Senior Secured Guarantors (collectively, the “Senior Secured Guarantees”), will be secured by:

- (i) a first ranking pledge over the New AH Proceeds Loan and the AWE Proceeds Loan;
- (ii) an assignment of claims and rights under the acquisition agreement signed by Altice Portugal in connection with the PT Portugal Acquisition;
- (iii) within 10 Business Days of the PT Portugal Acquisition, first ranking pledges over all of the shares of PT Portugal; and
- (iv) within 90 days following the PT Portugal Acquisition, first ranking pledges over all of the shares of PT OpCo, PT Cloud and PT Móveis.

The New Senior Secured Notes, as Senior Secured Debt, will also be secured by the following existing security:

- (i) first-ranking pledges over all of the share capital of the Senior Secured Notes Issuer, the Existing Senior Secured Guarantors (other than Altice International and, in respect of the 2013 December Senior Secured Notes and the New Senior Secured Notes only, Green, Cabovisão, Altice Portugal, Winreason, ONI S.G.P.S., Onitelem and Knewon) (the share pledges over the share capital of ODO, Global Interlink Ltd. and Tricom will be effective upon approval by Indotel), the capital stock of HOT and ABO;
- (ii) a first-ranking pledge over the bank accounts and all receivables of the Senior Secured Notes Issuer, including the Senior Secured Notes Issuer Pledged Proceeds Notes;
- (iii) first-ranking pledges (or assignments, as applicable) over all of the material assets of each Existing Senior Secured Guarantor and the Covenant Party Pledged Proceeds Loans, other than (i) shares of Altice Blue Two held by Altice Caribbean, (ii) licenses and real estate assets below €5 million in the Dominican Republic, (iii) in respect of the 2013 December Senior Secured Notes and the New Senior Secured Notes only, the assets of ABO, (iv) Cabovisão, Altice Portugal, Winreason, ONI S.G.P.S., Onitelem and Knewon; (v) the HOT Minority Shareholder Call Options and certain management options) and (vi) the Onitelem Proceeds Notes and the Cabovisão Proceeds Notes;
- (iv) a first-ranking pledge over the Senior Notes Proceeds Loans (as defined in note 14 below); and
- (v) a first-ranking pledge over the Cool Shareholder Loan.

The maximum liability of Altice Portugal, PT Portugal and PT OpCo under the Senior Secured Debt and Senior Notes collectively is limited to the Aggregate Portuguese Security and Guarantee Limit, as applicable.

The Senior Secured Debt (other than the 2013 December Senior Secured Notes, the New Revolving Credit Facilities, the New Term Loan and the New Senior Secured Notes) will be secured (up to an amount equal to the applicable Aggregate Portuguese Security and Guarantee Limit) by:

- (i) a first ranking pledge over all of the share capital of Altice Portugal and Cabovisão; and
- (ii) first ranking security over all material assets of Altice Portugal and Cabovisão (including pledge of bank accounts of Cabovisão, pledge and assignment of shareholders' credits of Altice Portugal, floating charge over the business as a going concern of Cabovisão and pledge of € 24 million unsecured Cabovisão bonds).

The Senior Secured Debt (other than the 2013 December Senior Secured Notes, the New Revolving Credit Facilities, the New Term Loan and the New Senior Secured Notes) will also be secured (up to an amount equal to the applicable Aggregate Portuguese Security and Guarantee Limit) by:

- (i) a first ranking pledge over the shares of ONI S.G.P.S., its wholly owned subsidiaries (including Onitelem, Hubgrade, F300 and Knewon); and
- (ii) first ranking security over certain assets and rights of Winreason, ONI S.G.P.S. and its wholly owned subsidiaries (including pledge and assignment as security of shareholders' credits, pledge of certain bank accounts of ONI S.G.P.S. and its subsidiaries and pledge and assignment as security of the receivables under certain telecommunication contracts).

Pursuant to the Intercreditor Agreement, the holders of the New Senior Secured Notes and the lenders under the New Revolving Credit Facilities will share in the proceeds of enforcement of the PT Portugal Security, Cabovisão Security and the ONI Security up to an amount equal to the Aggregate Portuguese Security and Guarantee Limit, as applicable.

The Senior Secured Debt will be secured by a pledge of the HOT Refinancing Notes and thereby indirectly benefit from the guarantees and security provided with respect to the HOT Refinancing Notes (up to the amount outstanding under the HOT Refinancing Notes). See note 11 below. The HOT Refinancing Notes (including principal and interest payments) are guaranteed by the HOT Refinancing Note Guarantors and are secured by a pledge over substantially all of the assets of HOT (including all of the share capital of HOT Mobile) and the HOT Refinancing Note Guarantors but, in each case, excluding licenses granted by the Israeli Ministry of Communications and certain end-user equipment, with respect to which HOT is not permitted to grant a security interest (the "HOT Refinancing Note Collateral").

The Senior Secured Debt will be secured by a pledge of Altice Holdings' interests under the Coditel Senior Facility and thereby indirectly benefit from the guarantees and security provided with respect to the Coditel Senior Facility (up to the amount outstanding under the Coditel Senior Facility). See note 11 below. The Coditel Senior Facility is guaranteed by Coditel Luxembourg and is secured by a pledge of shares and other equity interests in Coditel Holding and Coditel Belgium, receivables and bank accounts of Coditel Holdings and its parent company, including the €106 million intercompany loan to Coditel Belgium (the "Existing Coditel Proceeds Loan"), and trade, insurance, intra- group and other receivables and bank accounts of Coditel Luxembourg. In addition, as a result of the pledge of the Existing Coditel Proceeds Loans, lenders under the Coditel Senior Facility indirectly benefit from a pledge of certain assets of Coditel Belgium.

The Senior Secured Debt will be secured by a pledge of the Outremer Proceeds Loans and the Le Cable Proceeds Loans and will thereby indirectly benefit from the security that will secure the Outremer Proceeds Loans, the Le Cable Proceeds Loans, the ABT Convertible Bonds and the GOT On-Loan (in each case, up to the amount outstanding under the relevant intercompany loan). See note 11 below. Each Outremer Proceeds Loan, each Le Cable Proceeds Loan, the ABT Convertible Bonds and the GOT On-Loan is secured by a pledge of certain assets of the relevant company that is the borrower or issuer under such intercompany loan or convertible bonds, including capital stock of the direct subsidiaries held by such borrower or issuer (other than subsidiaries in Mauritius and excluding shares held by Altice Caribbean in Altice Blue Two), receivables of such borrower or issuer and other significant assets (excluding network assets) owned by such borrower or issuer.

The obligations of a Senior Secured Guarantor under its Senior Secured Guarantee and the obligation of guarantors under the other guarantees described above will be limited as necessary to prevent the relevant Senior Secured Guarantee or guarantee from constituting a fraudulent conveyance under applicable law (if any), or otherwise to reflect limitations under applicable law or capital maintenance regulations (if any) provided that, for the avoidance of doubt, ABO will not provide a Senior Secured Guarantee in respect of the New Senior Secured Notes. See "*Limitation on Validity and Enforceability of Guarantees and the Security Interests*" and "*Risk Factors—Risks*"

Relating to the New Notes and the Structure—Corporate benefit and financial assistance laws and other limitations on the obligations under the Guarantees may adversely affect the validity and enforceability of the Guarantees”.

- (4) On the release of the proceeds of the offering of the New Senior Notes from the escrow accounts, the New Senior Notes and the Existing Senior Notes (together, the “Senior Notes”) will be guaranteed on a senior subordinated basis (the “Senior Notes Guarantees” and, together with the Senior Secured Guarantees, the “Guarantees”) by the Existing Guarantors and, within 90 days of the PT Portugal Acquisition, the Acquired Guarantors (up to an amount equal to the applicable Aggregate Portuguese Group Security and Guarantee Limit) (and in respect of the 2012 Senior Notes and the 2013 June Senior Notes only, ABO) (the “Senior Notes Guarantors” and, together with the Senior Secured Notes Guarantors, the “Guarantors”). Following the release of the proceeds of the offering of the New Senior Notes from the escrow accounts, the New Senior Notes and the Senior Notes Guarantees will be secured by:
- (i) a first-ranking pledge over all of the share capital of the Senior Notes Issuer;
 - (ii) second-ranking pledges over all of the share capital of the Senior Secured Notes Issuer, Cool Holding and Altice Holdings;
 - (iii) second-ranking pledges over the Senior Notes Proceeds Loans; and
 - (iv) a second-ranking pledge over the Cool Shareholder Loan.

Since the Senior Notes Guarantees are subordinated in right of payment to the Senior Secured Debt, the Aggregate Portuguese Security and Guarantee Limit will effectively mean that the creditors of the Senior Secured Debt will be entitled to all amounts available from Altice Portugal and Cabovisão in the event of enforcement unless such Senior Secured Debt is repaid through other means.

The obligations of a Senior Notes Guarantor under its Senior Notes Guarantee will be limited as necessary to prevent the relevant Senior Notes Guarantee from constituting a fraudulent conveyance under applicable law (if any), or otherwise to reflect limitations under applicable law or capital maintenance regulations (if any) provided that, for the avoidance of doubt, ABO will not provide a Senior Notes Guarantee in respect of the New Senior Notes. See “*Limitation on Validity and Enforceability of Guarantees and the Security Interests*” and “*Risk Factors—Risks Relating to the New Notes and the Structure—Corporate benefit and financial assistance laws and other limitations on the obligations under the Guarantees may adversely affect the validity and enforceability of the Guarantees*”.

- (5) In connection with its mobile license for 3G services, HOT Mobile provided a bank guarantee in the amount of NIS 695 million to the State of Israel. HOT Mobile’s obligation to the bank that issued such guarantee is secured by a pledge of all of its assets. As of the first testing date on September 26, 2013, we have achieved a market share calculated in accordance with the license agreement that entitled us to a deduction of the entire amount of the NIS 695 million license fee outstanding. Accordingly, we requested the Israeli Ministry of Communications to reduce the amount of the bank guarantee to an amount of NIS 80 million as a guarantee of our obligation to achieve certain territorial coverage requirements under our license. On November 21, 2013, the Israeli Ministry of Communications notified HOT Mobile that the license fees shall be decreased to NIS 10 million (which has already been paid) and the bank guarantee shall be decreased from the amount of NIS 695 to an amount of NIS 80 million. HOT Mobile is not a guarantor under the HOT Refinancing Note. HOT Mobile will not be a Guarantor or provide any security with respect to the Senior Secured Debt or the Senior Notes.
- (6) The Existing HOT Unsecured Notes are senior unsecured obligations of HOT which mature on September 30, 2018. As of September 30, 2014, the total principal amount of the Existing HOT Unsecured Notes outstanding was €261.2 million equivalent. The Existing HOT Unsecured Notes are:
- (i) effectively subordinated to the HOT Refinancing Notes and the guarantees thereof granted by the HOT Refinancing Note Guarantors to the extent of the lesser of (x) the value of the assets of HOT and the HOT Refinancing Note Guarantors securing the HOT Refinancing Notes and the guarantees thereof and (y) the amount owing under the HOT Refinancing Notes;
 - (ii) pari passu with the HOT Refinancing Notes to the extent the amount of the HOT Refinancing Notes exceeds the value of the assets of HOT and the HOT Refinancing Note Guarantors securing the HOT Refinancing Notes and the guarantee thereof; and
 - (iii) structurally senior to the Senior Secured Debt and the Senior Notes and the guarantees thereof granted by the Guarantors.

The Existing HOT Unsecured Notes are not subject to the Intercreditor Agreement and, as a result, in the event of an enforcement sale of the shares of Cool Holding or HOT pursuant to the Intercreditor Agreement, the debt claims of the holders of the Existing HOT Unsecured Notes are not required to be released or otherwise transferred.

- (7) Pursuant to the terms of the Intercreditor Agreement, the lenders under the New Super Senior Revolving Credit Facility, the 2012 Revolving Credit Facility and the 2013 Revolving Credit Facility (together, the “Revolving Credit Facilities”) and certain hedge counterparties will be entitled to receive payments from the proceeds of any enforcement of such security and from certain distressed disposals of the property and assets subject to such security prior to the holders of the other Senior Secured Debt and the Senior Notes. See “*Description of Other Indebtedness—The Existing Revolving Credit Facility Agreements and the 2013 Guarantee Facility*”.
- (8) Each Guarantor (other than Cabovisão, PT OpCo, Green, Tricom S.A., Global Interlink Ltd. and ODO) is a holding company and does not conduct any operations and is wholly dependent on payments from its respective subsidiaries to meet its obligations, including its obligations under its Guarantee of the Senior Secured Debt and the Senior Notes and respective Pledged Proceeds Note.
- (9) On or prior to the Completion Date, the Senior Secured Notes Issuer will borrow €841 million (equivalent) under the New Term Loan and will use the proceeds thereof together with the gross proceeds of the New Notes and the amounts borrowed under the Senior Notes Proceeds Loan to make an intercompany loan to Altice Holdings. See note 14 below.
- (10) Altice International is a part of the restricted group (and a guarantor) for the New Indentures, the New Revolving Credit Facilities, the New Term Loan, the 2013 Term Loan, the 2013 Revolving Credit Facility, the 2013 Guarantee Facility and the 2013 June Senior Notes. Altice International is also a guarantor under the 2012 Senior Secured Notes Indenture, the 2012 Senior Notes Indenture and the 2012 Revolving Credit Facility, but is not subject to the covenants thereunder.

- (11) The Senior Secured Debt and the Senior Notes do not constitute direct obligations of any members of the Group that are not Guarantors, including HOT, the HOT Refinancing Note Guarantors, Coditel Holding, Coditel Luxembourg, Coditel Belgium and Altice Blue Two and any of their respective subsidiaries. Upon an event of default under the Senior Secured Debt or the Senior Notes, any member of the Group that is not a Guarantor shall not be directly liable in any way, including by way of cross default, and shall not be required to repay any amounts outstanding, including any repayment premiums and accrued and unpaid interest thereon, under the Senior Secured Debt or the Senior Notes.

HOT and the HOT Refinancing Note Guarantors will only be liable for their obligations as borrower and guarantors respectively under the HOT Refinancing Notes. Therefore, the obligations of HOT and the HOT Refinancing Note Guarantors will be limited to an aggregate amount equal to the amount outstanding under the HOT Refinancing Notes, which may vary from time to time in accordance with the terms of the HOT Refinancing Notes. As of September 30, 2013, the amount outstanding under the HOT Refinancing Notes was NIS 1,900 million.

Coditel Holding S.A. and Coditel Luxembourg will only be liable for their obligations as borrower and guarantor respectively under the Coditel Senior Facility. In addition, Coditel Belgium will only be liable for its obligations under the Existing Coditel Proceeds Loan. Therefore, the obligations of Coditel Holding S.A., Coditel Luxembourg and Coditel Belgium will be limited to an aggregate amount equal to the amount outstanding under the Coditel Senior Facility and the Existing Coditel Proceeds Loan, as applicable, which may vary from time to time in accordance with their terms. Further, any enforcement action with respect to, and recovery under, the Coditel Senior Facility or the Existing Coditel Proceeds Loan will be subject to the Existing Coditel Intercreditor Agreement. As of September 30, 2014, the amount outstanding under the Coditel Senior Facility and the Existing Coditel Proceeds Loan were €131 million and €106 million, respectively.

Each borrower or issuer under the Outremer Proceeds Loans, the Le Cable Proceeds Loans, the ABT Convertible Bonds and the GOT On-Loan will only be liable for its obligations under the relevant intercompany loan or convertible bonds. Therefore, the obligations of each borrower or issuer under the Outremer Proceeds Loans, the Le Cable Proceeds Loans, the ABT Convertible Bonds and the GOT On-Loan will be limited to an amount equal to the amount outstanding under the relevant intercompany loan or convertible bonds, which may vary from time to time in accordance with their terms. For the principal amount of such Outremer Proceeds Loans, the Le Cable Proceeds Loans, the ABT Convertible Bonds and the GOT On-Loan, see note 2 above.

If there is an event of default under the Senior Secured Debt, HOT, the HOT Refinancing Note Guarantors, Coditel Holding S.A. and Coditel Luxembourg will only have liability to the holders of the Senior Secured Debt if there is also an event of default continuing under the HOT Refinancing Notes or the Coditel Senior Facility, as applicable, in each case, indirectly as a result of an assignment of the HOT Refinancing Note or Altice Holdings' interest in the Coditel Senior Facility and/or the ability of the holders of the Senior Secured Debt to direct the actions of the Senior Secured Notes Issuer or Altice Holdings, as applicable, in connection with such assignment in accordance with the terms of the Intercreditor Agreement, to the extent permitted thereby. If there is an event of default under the Senior Secured Debt, the borrowers under the Outremer Proceeds Loans and the Le Cable Proceeds Loans will only have liability to the holders of the Senior Secured Debt if there is also an event of default continuing under the Outremer Proceeds Loans or the Le Cable Proceeds Loans, as applicable (which is subject to an equity cure) in each case indirectly as a result of an assignment of the relevant Outremer Proceeds Loan or Le Cable Proceeds Loan, as applicable and/or the ability of the holders of the Senior Secured Debt to direct the actions of Altice Holdings in connection with such assignment in accordance with the terms of the Intercreditor Agreement, to the extent permitted thereby. The security interests securing the Outremer Proceeds Loans and the Le Cable Proceeds Loans cannot be enforced unless there is an event of default under the Outremer Proceeds Loans or the Le Cable Proceeds Loans, as applicable (which is subject to an equity cure) and an event of default under the 2013 Term Loan or the 2013 June Senior Notes, which has resulted in enforcement actions due to which Altice International does not exercise control over the relevant pledgor. Further, in addition to the above, Altice Blue Two Invest will only have liability to the holders of the Senior Secured Debt if there is also an event of default continuing under the ABT Convertible Bonds, indirectly as a result of an assignment of the ABT Convertible Bonds by Altice Caribbean in favor of Altice Holdings and the assignment of the relevant Pledged Proceeds Note and Groupe Outremer Telecom will only have liability to the holders of the Senior Secured Debt if there is also event of an event of default under the GOT On-Loan, indirectly as a result of an assignment of the GOT On-Loan by OMT Invest in favor of Altice Holdings and the assignment of the relevant Pledged Proceeds Note.

If there is an event of default under the Senior Secured Debt, Coditel Belgium will only have liability to the holders of the Senior Secured Debt if there is also an event of default continuing under the Existing Coditel Proceeds Loan, indirectly as a result of a pledge of the Existing Coditel Proceeds Loan in favor of the lenders under the Coditel Senior Facility and the assignment of Altice Holding's interest thereunder and/or the ability of the holders of the Senior Secured Debt to direct the actions of Altice Holdings (and indirectly Coditel Holding S.A.) in connection with the Coditel Senior Facility in accordance with the terms of the Intercreditor Agreement, to the extent permitted thereby. Any enforcement action with respect to, and recovery under, the Coditel Senior Facility or the Existing Coditel Proceeds Loan will also be subject to the Existing Coditel Intercreditor Agreement.

- (12) Cool Holding and SPV1 collectively own 100% of the outstanding shares of HOT. Pursuant to the HOT Minority Shareholder Agreements, during the 24-month period commencing on the first anniversary of the Take-Private Transaction, the HOT Minority Shareholders will have the right to purchase shares of HOT sold pursuant to the Take-Private Transaction (representing approximately 11% of the outstanding shares of HOT) at a price of NIS 48 per share from SPV1. See "*Description of Our Business—Material Contracts—HOT Minority Shareholder Agreements*". In the event that the HOT Minority Shareholders exercise their rights to acquire shares of HOT, such shares will be released from the pledges that secure the Senior Secured Debt. If the HOT Minority Shareholders exercise such rights, the HOT Minority Shareholders will own approximately 11% of the share capital of HOT. In addition, the HOT Minority Shareholder Agreements grant certain rights to the Minority Shareholders, including, after the exercise of any such rights to acquire shares of HOT, the right to approve certain asset dispositions and the incurrence of material indebtedness. The HOT Minority Shareholder Agreements and the rights granted thereunder to the Minority Shareholders will continue to apply following any enforcement of the pledges over the capital stock of HOT or Cool Holding.

Upon the exercise of certain Minority Shareholder Call Options (as defined under "Description of Senior Secured Notes" and "Description of Senior Notes"), the Senior Secured Notes Issuer must offer to repurchase or prepay as applicable, the 2012 Senior Secured Notes, the 2013 Term Loan, the New Term Loan and the New Senior Secured Notes, at a price equal to 103% of the principal amount plus accrued and unpaid interest and additional amounts, if any, with the net cash proceeds of such Minority Shareholder Call Options. In the event there are any remaining net cash proceeds after the completion of such offer, the Senior Notes Issuer must offer to repurchase the New Senior Notes and the Existing Senior Notes at a price equal to 103% of the principal amount plus accrued and unpaid interest and additional amounts, if any, with such remaining net cash proceeds. See "*Description of Senior Secured Notes—Offer to Repurchase with Minority Shareholder Option Proceeds*" and "*Description of Senior Notes—Offer to Repurchase with Minority Shareholder Option Proceeds*".

- (13) All of the assets of HOT are currently pledged on a second priority basis to the State of Israel to secure certain payment obligations (which are subordinated to the HOT Refinancing Notes) related to our ownership of the cable network. The final installment of such payment obligations will be due on January 1, 2015. As of September 30, 2014, the total amount of such payment obligations was approximately NIS 22 million. See “*Description of Our Business—Material Contracts—Agreement with State of Israel relating to ownership of our cable network*”.
- (14) In connection with the issuance of the New Notes offered hereby, the Senior Notes Issuer will make an intercompany loan of the gross proceeds of the offering of the New Senior Notes (the “New Senior Notes Proceeds Loan” and, together with the 2012 Senior Notes Proceeds Loan, the 2013 June Senior Notes Proceeds Loan and the 2013 December Senior Notes Proceeds Loan, the “Senior Notes Proceeds Loans”) to the Senior Secured Notes Issuer, which in turn will use amounts borrowed under the New Senior Notes Proceeds Loan, the amounts borrowed under the New Term Loan, the gross proceeds of the offering of the New Senior Secured Notes and any amounts borrowed under the New Super Senior Revolving Credit Facility to make an aggregate €3,724 million equivalent proceeds loan (the “New AH Proceeds Loan”) to Altice Holdings. In addition, it is expected that Altice S.A. will contribute the proceeds of the New ASA Senior Notes to Altice International in exchange for mandatory convertible notes of €2,055 million aggregate value (with €100,000 nominal value each) to be issued by Altice International and to be subscribed by Altice S.A., and Altice International will, in turn, contribute such proceeds to Altice Holdings (the “ASA Notes Proceeds Contribution”). Altice Holdings will use the proceeds under the New AH Proceeds Loan and the ASA Notes Proceeds Contribution to make a proceeds loan (the “AWE Proceeds Loan”) to Altice West Europe, which in turn will use the proceeds under the AWE Proceeds Loan to make a proceeds loan (the “AP Proceeds Loan”) to Altice Portugal to consummate the PT Portugal Acquisition.
- As part of the PT Portugal Acquisition, Altice Portugal will (i) on-lend €5,604 million borrowed under the AP Proceeds Loan to PT Portugal so that PT Portugal can repay €4,634.4 million of its existing debt, (ii) PT Portugal will then on-lend €969.6 million of the amounts received from Altice Portugal to PT OpCo so that PT OpCo can repay €968.4 million of its existing debt and €1.2 million of the amounts received from PT OpCo to PT Móveis, which in turn will on-lend all such amounts to SIRESP so that SIRESP can repay € 1.2 million of its existing debt (all such loans together, the “PT Group Loans”).
- (15) The Restricted Group excludes Valvision, Green Datacenter and Auberimmo (and in the case of the Senior Secured Notes, also excludes the Senior Notes Issuer). We disposed of our interests in Valvision in 2013 to the Numericable Group. Green Datacenter and Auberimmo are designated as unrestricted subsidiaries under the terms governing the indebtedness of the Group. Valvision’s contribution to our revenue and EBITDA was not material. In each of the years ended December 31, 2011, 2012 and 2013, Green Datacenter contributed €4.3 million, €10.3 million and €12.4 million to aggregated and pro forma revenues and € 3.6 million, €9.0 million and €10.2 million to aggregated and pro forma EBITDA and Auberimmo’s contribution to our revenue and EBITDA was not material. For the nine months ended September 30, 2013 and 2014, Green Datacenter contributed €8.8 million and € 8.2 million to pro forma revenue and €7.6 million and € 6.9 million to pro forma EBITDA, respectively. In connection with the approval of the Altice Group’s acquisition of SFR, the French Competition Authority has required us to undertake divestitures of our mobile businesses in La Réunion and Mayotte.

LIMITATION ON VALIDITY AND ENFORCEABILITY OF THE GUARANTEES AND THE SECURITY INTERESTS

Set forth below is a summary of certain limitations on the enforceability of the Guarantees and the Collateral in each of the jurisdictions in which the Issuers and the Guarantors are organized.

Israel

General Corporate Power

The Israeli Companies Law, 5759-1999 requires a company to indicate its purpose in its articles of association. Thus, the general corporate capacity of an Israeli company to provide a guarantee or security may be limited by its organizational documents (i.e. its articles of association).

Subject to any specific provision in a company's organizational documents, a grant of security or a guarantee by an Israeli company would generally require the approval of its board of directors, absent the existence of any interested party transactions. Transactions involving interested parties may also require approvals of the shareholders, audit committee and/or independent directors.

Limitation on Distributions and Fiduciary Duties

Under Israeli law, in certain circumstances, a company's undertaking to guarantee or provide security for the benefit of its parent company with respect to an amount in excess of the amounts actually received by such company (i.e., with respect to excess amounts received by other entities), will result in the excess being a "distribution" under Israeli law, which term also includes a company purchasing its own shares or assisting with the purchase thereof. Under Israeli law, a company may only make distributions up to the amount of the greater of: (i) its retained earnings and (ii) its cumulative net income over the preceding eight quarters (and provided that it meets the Solvency Test as defined under Israeli law) ("Distributable Profits"). Distributable Profits will be reduced by the amount of prior distributions to the extent not already reflected in the calculation of Distributable Profits. Any distribution which is not out of Distributable Profits will require court approval.

The fiduciary duty of directors requires that they act in the best interests of the company. Thus, the board of directors must determine in each case whether granting a guarantee or security interest is in the best interest of the company.

Security Interests

Under Israeli law, there are generally two types of charges, a fixed charge and a floating charge. A fixed charge is the charge of a certain asset as a security until the debt secured by the charge is settled. A floating charge is a charge over all or an unspecified part of the assets of a company, including its future assets. Unless otherwise specifically stated, a floating charge would include all of a pledging company's assets that by their nature may change from time to time in accordance with the company's business and the nature of its operations. Generally and unless otherwise restricted pursuant to the debenture under which it is created, a floating charge does not restrict the company's conduct in its ordinary course, the sale of the charged assets in the ordinary course of business, or the imposition of additional charges and liens on the company's assets. When the floating charge crystallizes (for example, upon a default), it becomes, in effect, a fixed charge over all the company's assets at the time of crystallization.

A security interest is generally created by an agreement between the company and the creditor (certain security interests by operation of law excluded). The security is perfected against third parties if registered with the Companies Registrar within 21 days of its creation (or, if created by a non Israeli company, upon registration with the Registrar of Pledges); however, certain charges may be perfected by the possession of the asset by the creditor or its agent. A charge over real-estate of a company (a "mortgage") must also be registered with the Land Registry Bureau. Charges over vessels, patents, trademarks and other assets subject to separate government registrars may be also registered with such registrars.

Enforcement of Guarantee and Securities

General

A guarantee is governed by the Guarantee Law, 5727-1967 and is generally enforced as a contract under Israeli law.

Under Israeli law, the realization of a pledge generally requires a court order or, with respect to certain assets, an order from the Office of Execution of Judgments and as a practical matter generally results in the appointment of a receiver to manage the assets under supervision of the court. Certain limited exemptions allowing for self-realization apply with

respect to certain pledges in favor of certain institutional entities (namely a “Banking Institution” under Israeli law, the Bank of Israel, Israeli insurance companies, Israeli Provident Funds Management Companies, and members of the Tel Aviv Stock Exchange) and certain securities pledges in favor of certain institutional entities. Certain terms and conditions apply to any such “self help” realization procedures including, without limitation, the obligation to provide notice and the obligation to sell the pledged assets in the manner common in the applicable market of the asset (and in the absence of such market, in a reasonable commercial manner).

Israeli courts would apply Israeli law for the creation, perfection, and enforcement of a security created by an Israeli company over its assets located in Israel. In addition, Israeli courts would generally apply Israeli law for the creation, perfection and enforcement of a security created by a non Israeli company over shares physically located in Israel.

Insolvency

Under Israeli law, if, among other things, a company is insolvent or the company adopts a special resolution approving a court-supervised liquidation, a company can be placed into involuntary liquidation through a liquidation order issued by the court. Upon the issuance of a liquidation order with respect to an Israeli company in the process of liquidation by the court (or the appointment of a liquidator therefor), there is an automatic stay of proceedings. The court may also impose a stay prior to the granting of the order of liquidation but after the filing of a petition for liquidation. In a process of voluntary dissolution, which is initiated by the determination of shareholders to dissolve the company, while there is no automatic stay of proceedings, the liquidator may apply to the court for a stay of proceedings.

As long as the stay is in effect, the continuance or commencement of any proceeding against the company is prohibited other than with the permission of the court or upon certain limited circumstances, which include the right of secured creditors to enforce their security to recover up to the amount of their secured debt. Any balance from such realization exceeding the secured debt will form part of the assets of the company to be distributed by the liquidator. If the value of the security is less than the value of the debt, then the secured creditor may recover the balance of the sum owed to it (exceeding such value) *pari passu* with the unsecured creditors. In addition, the liquidator may disclaim certain unfavorable contracts of the company.

Israeli insolvency law generally favors the continuation of a business over immediate payment of creditors. The following factors, among others, may affect rights of secured creditors generally and in insolvency proceedings particularly:

- Fraudulent conveyance principles and other similar laws affecting creditors’ rights and remedies generally and by application by a competent court of equitable principles. Under Israeli law, any transfer of asset or creation of a security interest by a debtor may be declared not enforceable in liquidation, reorganization or composition proceedings of the debtor if, generally, the following conditions are met: (a) the debtor is deemed insolvent (as defined in and construed under Israeli law principles) at the time of the conveyance; (b) the conveyance is effected in the three months prior to the commencement of the liquidation or reorganization proceedings; and (c) the conveyance is made by the debtor with the intention of fraudulently preferring a certain creditor or as a result of illegal coercion or persuasion by the creditor. A specific fraudulent conveyance rule applies to security interests created under a floating charge. Under Israeli law, a floating charge created during the six months prior to the start of the liquidation, reorganization or composition proceedings, may be construed as invalid as to the indebtedness secured thereunder and not advanced by the creditor holding the floating charge at the creation of the pledge or immediately thereafter (together with interest at the rate set by law), unless sufficient proof exists to support the fact that the debtor was solvent immediately following the creation of the floating charge.
- The issuance of a liquidation order by a court of competent authority in respect of a company results in a stay of proceedings. Upon the issuance of the liquidation order, creditors of a company are prohibited from taking any action against the company or its assets to secure or realize their rights, and any such proceedings not completed are stayed. However, the liquidation order does not prevent creditors holding a secured interest from enforcing and realizing their collateral or to otherwise use it in a different manner (although the enforcement process may be procedurally limited in a certain manner). Notwithstanding the foregoing, a court of competent authority may order a moratorium on proceedings against a company for a period of up to nine months (and may extend that period for additional three month periods (without limitation as to the aggregate time frame), for special reasons) if the court is convinced that the moratorium may contribute to the formation of a compromise or arrangement between the company, its shareholders and its creditors. Secured creditors are restricted from enforcing their collateral during the moratorium period, unless the court is convinced that either (i) no adequate protection exists to safeguard the secured creditors’ rights or (ii) enforcement of the secured creditor’s rights will not jeopardize the ability of the company to duly form and approve the arrangement or compromise so contemplated.

Claims and rights of creditors of a company in insolvency proceedings may abate in whole or in part due to insufficient funds and assets of the company in insolvency. Generally, the distribution of assets in insolvency proceedings is

governed by two core principles: the principle of absolute superiority, according to which creditors of a certain class, who rank higher in priority to other creditors, will be permitted to satisfy their interests in full prior to creditors of a different class, who rank lower in priority, and the principle of absolute equality, according to which creditors of the same class will have a pro rata right to secure and satisfy their interest with other creditors of the same class. Generally, subject to certain exceptions, creditors holding a fixed pledge or charge rank higher in priority to shareholders and other unsecured creditors of a company and may, subject to the limitations described above, proceed in enforcing their security interest without interference. Such creditors are entitled to use the proceeds received in connection with the realization of their security interest to satisfy their entire claim but will be treated as unsecured creditors with respect to any portion of their claim not entirely satisfied by the proceeds so received if such proceeds are insufficient to repay their entire interest. Creditors holding a fixed pledge or charge may, however, be subordinated to (i) certain creditors statutorily preferred under Israeli law (e.g. tax authorities holding a tax lien in respect of taxes owed and not paid on real estate property of the company), (ii) certain creditors holding a statutory lien, and (iii) creditors holding a fixed pledge or charge over specific assets which were acquired or received by the company using debt advanced by such creditors.

Reorganization

The Israeli Companies Law provides for a reorganization process for a company regardless whether the company is insolvent. A company (or an administrator or liquidator) or any creditor or shareholder of a company may request the court to summon a meeting of creditors or shareholders to agree to a compromise or arrangement between the company and its creditors or shareholders.

The court has a general authority to impose a stay of proceedings upon a request for a creditors and/or shareholders arrangement or compromise. As long as the stay is in effect, the continuance or commencement of any proceeding against the company is prohibited, including the realization of pledged assets and crystallization of a floating charge which require the consent of the court, which is conditioned upon the court determining that the pledgee was not provided adequate protection, or that the realization would not undermine the ability to formulate and approve the plan.

Furthermore, based on an amendment to the Israeli Companies Law which became effective in January 2013, the following additional factors may adversely affect rights of secured creditors:

- without approval of creditors, a company will be permitted to use an asset which is subject to a charge, including selling the asset free of liens (in the ordinary course of business with either the agreement of the creditor or court approval, and not in the ordinary course of business if approved by the court) if necessary for the reorganization of the company. The secured creditor must have “adequate protection”, either from the proceeds of the sale or an asset acquired to replace the asset subject to the disposition. If the asset which is subject to a security interest is sold, the proceeds of sale or any replacement asset which can be identified or traced will be subject to a corresponding security interest in favor of the secured creditor.
- without approval of creditors, the company will be able to raise new financing for the continued operations of the company subject to a stay order issued by a court. This new financing is treated as an expense of the reorganization, and is therefore given priority over other liabilities of the company. In such a financing, the company may create a charge in favor of the lenders that would have priority to the existing security interests if the court believes it necessary for the company to raise the funds. The court would need to be satisfied that there is “adequate protection” for the existing secured creditors notwithstanding the creation of the new security interest. See “*Limitation on Validity and Enforceability of the Guarantees and the Security Interests—Israel*”.

Similarly, in the event that rehabilitation or restructuring is not sought or does not succeed, the rights of the holders of the New Notes and the Trustee to enforce remedies are likely to be sufficiently impaired by bankruptcy, receivership or other liquidation proceedings under applicable Israeli laws such as the Bankruptcy Ordinance (New Version)—1980 and the Companies Ordinance (New Version)—1983, if the benefit of such laws is sought.

Special Regulatory Approvals

The approval of the Israeli Ministry of Communications is required prior to the realization of the security interest granted (whether directly or indirectly) over the shares of Cool Holding, SPV1, HOT and HOT Net and the interests in HOT Telecom Limited Partnership, and prior to a realization that would result (whether directly or indirectly) in a change in the identity of the shareholders of a licensee under the Telecommunications Law, and over the assets of HOT (which realization may not interfere with the orderly provision of the services). There is no set time period for review by the Israeli Ministry of Communications and such approval may be withheld or delayed by the Israeli Ministry of Communications in its sole discretion.

Priority of Claims

Generally, the priority of claims on a company's assets will be determined in the following order:

1. Secured Creditors—including: (a) statutory pledges, such as taxes due; (b) certain costs related to execution of judgments; and (c) secured creditors with valid security interests including fixed equitable charges, legal mortgage and floating charges which crystallize prior to the liquidation process and holders of a contractor's lien;
2. Liquidation expenses;
3. Preferential creditors—specifically certain employee wages (to a limited extent), and different payments or taxes to tax authorities;
4. Pledges under floating charges which crystallized with the liquidation of the company;
5. Unsecured creditors; and
6. Shareholders.

Luxembourg

The conditions to be satisfied by the granting of guarantees/security interests relate to (i) corporate power, (ii) corporate authority, and (iii) corporate benefit. These rules are derived from general principles and must be applied to specific circumstances, which have to be analyzed on a case by case basis.

Corporate power

Limits on corporate power can either be imposed (i) by law or (ii) by the articles of association of the company.

1. Limitations imposed by law.

Pursuant to the Luxembourg Civil Code, a company is incorporated with a view to participate in the profits (and the losses) which may arise therefrom. The goal to share the profits is an essential element of every company and therefore, a purely free (or gratuitous) act, without consideration, may be outside the scope of the activities of a company as contemplated by law. A company may however carry out gratuitous acts whenever these acts are accomplished with a view to the realization, directly or indirectly, of the company's corporate objective. It is normally understood that except in exceptional circumstances, an intragroup security is a type of act which may serve the purpose of realizing a profit.

Thus, it is only in exceptional circumstances when there is no reasonable indirect potential benefit of, or a motivated interest for, a proposed guarantee/security to be given by a company, that the validity of such a guarantee/security interest could be challenged for lack of any interest by the guarantor in providing the guarantee/security interest.

Further to this general legal restriction, additional limitations are imposed by specific laws, such as the prohibition to exercise a financial activity without a specific authorization (which in the case of a Luxembourg company, does not apply to financial activities within a group of companies) or the limitations on financial assistance to shareholders in the case of subscription or purchase of shares of the guarantor.

2. Limitations imposed by the articles of association.

The provision of guarantees or security interest by a company must be within the limits of the object clause of its articles of association.

Should the provision of a guarantee or security by a Luxembourg company be considered to exceed the corporate objective as expressed in the articles of association, the company is still bound by such action, unless there is evidence that the beneficiary of such acts knew that the acts exceeded the corporate objective or that the beneficiary could not, in light of the circumstances, have been unaware of that fact.

Corporate authority

When a Luxembourg company grants guarantees/security interests, applicable corporate procedures normally entail that the decision be approved by a board resolution or by decision of delegates that have been appointed for such purpose.

Corporate benefit

The third condition for a guarantee/security interest to be granted by a Luxembourg company is that the proposed action by the company must be “in the corporate interest of the company”, which words are a translation of the French *intérêt social*, an equivalent term to the English legal concept of corporate benefit. The concept of “corporate interest” is not defined by law, but has been developed by doctrine and court precedents and may be described as being “the limit of acceptable corporate behavior”. Whereas the previous discussions regarding the limits of corporate power are based on objective criteria (provisions of law and of the articles of association), the concept of corporate benefit requires a subjective judgment. In that context, the concept of a group of companies may be relevant, and while it should first be analyzed whether a transaction is in the best interest of the company on a standalone basis, it should also be examined whether the transaction is justified in the light of the interest at the level of the group, which may result in a benefit for the guarantor.

In general terms, group interest may justify the issue of a guarantee or the granting of security in favor of a parent company (upstream guarantee) or a sister company (cross stream guarantee), under the following circumstances:

- the proposed action must be justified on the basis of a common economical, social, or financial policy applicable throughout the whole group;
- the existence of a group should be evidenced through capital links; or
- the proposed action must not (i) be without any consideration, or alternatively (ii) break up the balance between the undertakings of the various group companies.

To the extent that all companies of the group are asked to bear in a similar way the burden of guarantees or security given for the benefit of the other group company or companies in an equal way, the obligation undertaken by a group company for the benefit of other group companies may be justified. Similarly, if a group company cannot exist outside of the group and is dependent on the group, assistance to other group companies should ultimately result in a benefit for such company. The limit of reasonable corporate behavior is reached when the transaction is exclusively in the interest of the parent company or the other companies of the group, without any benefit, direct or indirect, for the Luxembourg company granting the guarantee.

However, the failure to comply with the corporate benefit requirement will typically result in liability for the directors or managers of the guarantor concerned.

There is a limited risk that the directors or managers of the Luxembourg company be held liable if, *inter alia*:

- the guarantee/security interest so provided would materially exceed the (direct or indirect) benefit deriving from the secured obligations for the Luxembourg company; or
- the Luxembourg company derives no personal benefit or obtains no direct or indirect consideration for the guarantee/security interest granted; or
- the commitment of the Luxembourg company exceeds its financial means.

In addition to any criminal and civil liability incurred by the directors or managers of the Luxembourg company, the guarantee/security interest could itself be held unenforceable, if it is held that it is contrary to public policy (*ordre public*).

The above analysis is slightly different within a group of companies where a group interest (*intérêt du groupe*) exists. The existence of a group interest would prevent the guarantee/security interest from falling foul of the above constraints. In order for a group interest to be recognized, the following cumulative criteria must be met and proven:

- the “assisting” company must receive some benefit, or there must be a balance between the respective commitments of all the affiliates;
- the guarantee must not exceed the assisting company’s financial means;
- the companies involved must form part of a genuine group operating under a common strategy aimed at a common objective; and

- the assistance must be granted for purposes of promoting a common economic, social and financial interest determined in accordance with policies applicable to the entire group.

The criteria mentioned above have to be applied on a case-by-case basis and a subjective fact-based judgment is required to be made by the directors or managers of the Luxembourg guarantor.

As a result, the guarantees (upstream and cross stream) granted by a Luxembourg company are subject to certain limitations, which usually take the form of a general limitation language, which is inserted in the relevant transaction document(s) and which covers the aggregate obligations and exposure of the relevant Luxembourg assisting company under the transaction documents.

Each of the New Indentures contains the following limitation language:

The guarantee granted by any Guarantor which is incorporated and/or having its registered office and its place of central administration in Luxembourg (a “Luxembourg Guarantor”) for the obligations of the applicable Issuer which is not a direct or indirect subsidiary of such Luxembourg Guarantor shall be limited at any time to an aggregate amount not exceeding:

- (A) the aggregate amount of the outstanding intercompany loans made to the Luxembourg Guarantor or Subsidiaries of that Luxembourg Guarantor (which are Subsidiaries of that Luxembourg Guarantor on the Completion Date or which will be Subsidiaries of that Luxembourg Guarantor hereafter) by the applicable Issuer which have been funded directly or indirectly with proceeds deriving from the sale of the New Notes increased by
- (B) the greater of:
- (1) 90% of the Luxembourg Guarantor’s own funds (*capitaux propres*) and subordinated debt (*dettes subordonnées*, including for the avoidance of doubt intragroup liabilities), both as referred to in Article 34 of the Luxembourg law of 19 December 2002 on the commercial register and annual accounts, as amended (the “2002 Law”) as at the Completion Date (whether as original party or by way of accession); or
 - (2) 90% of the Luxembourg Guarantor’s own funds (*capitaux propres*) and subordinated debt (*dettes subordonnées*, including for the avoidance of doubt intragroup liabilities), both as referred to in Article 34 of the 2002 Law, as at the date on which a demand is made under the New Notes; or
 - (3) 90% of the net assets of the Luxembourg Guarantor calculated on the basis of the fair market value of the assets and liabilities of the Luxembourg Guarantor (as determined by the Agent or if the Agent so decides by a Luxembourg statutory approved auditor (*réviseur d’entreprise agréé*) (an “Independent Auditor”) as at the Completion Date (whether as original party or by way of accession); or
 - (4) 90% of the net assets of the Luxembourg Guarantor calculated on the basis of the fair market value of the assets and liabilities of the Luxembourg Guarantor (as determined by the Trustee or if the Trustee so decides by an Independent Auditor as at the date on which a demand is made under the New Notes).

Security interests considerations

According to Luxembourg conflict of law rules, the courts in Luxembourg will generally apply the *lex rei sitae* or *lex situs* (the law of the place where the assets or subject matter of the pledge or security interest is situated) in relation to the creation, perfection and enforcement of security interests over such assets. As a consequence, Luxembourg law will apply in relation to the creation, perfection and enforcement of security interests over assets located or deemed to be located in Luxembourg, such as registered shares in Luxembourg companies, bank accounts held with a Luxembourg bank, receivables/claims governed by Luxembourg law and/or having debtors located in Luxembourg, tangible assets located in Luxembourg, securities which are held through an account located in Luxembourg, bearer securities physically located in Luxembourg, etc.

If there are assets located or deemed to be located in Luxembourg, the security interests over such assets will be governed by Luxembourg law and must be created, perfected and enforced in accordance with Luxembourg law. The Collateral Act 2005 governs the creation, validity, perfection and enforcement of pledges over shares, bank accounts and receivables located or deemed to be located in Luxembourg.

Under the Collateral Act 2005, the perfection of security interests depends on certain registration, notification and acceptance requirements. A share pledge agreement must be (i) acknowledged by the company which has issued the

shares and (ii) registered in the shareholders' register of such company. If future shares are pledged, the perfection of such pledge will require additional registration in the shareholders' register of such company. A receivables pledge becomes enforceable against the debtor and against third parties by the mere entering into the pledge agreement by the pledgor and the pledgee. However, the debtor is validly discharged from its payment obligations by payment to the pledgor as long as it has not gained knowledge of the pledge.

Article 11 of the Collateral Act 2005 sets out the following enforcement remedies available upon the occurrence of an enforcement event:

- appropriate or cause a third party to appropriate this collateral at a price determined, before or after appropriation, by the valuation method agreed by the parties;
- assign or cause to be assigned the pledged collateral by private sale in a commercially reasonable manner, by sale over a stock exchange or by public auction;
- court allocation of the pledged assets to the pledgee in discharge of the secured obligations following a valuation made by a court appointed expert; or
- set-off between the secured obligations and the pledged assets.

As the Collateral Act 2005 does not provide any specific time periods and depending on (i) the method chosen, (ii) the valuation of the pledged assets, (iii) any possible recourses, and (iv) the possible need to involve third parties, such as, e.g. courts, stock exchanges and appraisers, the enforcement of the security interests might be substantially delayed.

The perfection of the security interests created pursuant to the pledge agreements does not prevent any third party creditor from seeking attachment or execution against the assets, which are subject to the security interests created under the pledge agreements, to satisfy their unpaid claims against the pledgor. Except as provided in article 20.4 of the Collateral Act 2005, a third party creditor may seek the forced sale of the assets of the pledgor which are subject to such security through court proceedings, although the beneficiaries under the relevant pledge or security documents will remain entitled to priority over the proceeds of such sale.

Under Luxembourg law, security interests qualifying as financial collateral arrangements under the Collateral Act 2005 may be granted in favor of a person acting on behalf of the beneficiaries of such security interests, a fiduciary or a trustee as a security for the claims of third party beneficiaries, present or future, to the extent that such third party beneficiaries are or may be determined.

Registration in Luxembourg

The registration of the transaction documents with the *Administration de l'Enregistrement et des Domaines* in Luxembourg may be required in the case of legal proceedings before Luxembourg courts or in the case that they must be produced before an official Luxembourg authority (*autorité constituée*). In such case, either a nominal registration duty or an ad valorem duty (or, for instance, 0.24% of the amount of the payment obligation mentioned in the document so registered) will be payable depending on the nature of the document to be registered. No ad valorem duty is payable in respect of security interest agreements, which are subject to the Collateral Act 2005.

The Luxembourg courts or the official Luxembourg authority may require that the transaction documents and any judgment obtained in a foreign court be translated into French or German.

Portugal

The conditions to be satisfied by the granting of guarantees/security interests relate to (i) capacity and (ii) corporate authority. These rules are derived from general principles and must be applied to specific circumstances, which have to be analyzed on a case by case basis.

Capacity

Limits on capacity can either be imposed (i) by law or (ii) by the articles of association of the company.

1. Limitations imposed by law.

Pursuant to the Portuguese Companies Code (*Código das Sociedades Comerciais*) (the "Companies Code"), a company incorporated in Portugal (a "Portuguese Company") has the capacity to enter into any agreements, including financing

and security agreements as long as they are necessary or convenient to pursue its purposes. Therefore, a purely free (or gratuitous) act, without consideration, may be outside the scope of the activities of a company as contemplated by law. A company may however carry out gratuitous acts whenever these acts are deemed usual in accordance with the circumstances of time and the own means of the company.

The Companies Code sets out some restrictions on capacity of Portuguese Companies, in particular in what concerns the granting of security interest and guarantees to secure and guarantee the obligations of third parties. Pursuant to article 6(3) of the Companies Code, companies may guarantee third parties' obligations provided that:

- The third party is in a controlling or a group relationship (*relação de domínio ou de grupo*) as defined in the Companies Code; or
- The company has a justified own interest (*justificado interesse próprio*) in guaranteeing the obligations of such company.

Under the Companies Code the definition of “controlling relationship” includes relationships between Portuguese companies where one holds, directly or indirectly the majority of the share capital or the voting rights in, or the right to appoint the majority of the members of the board of directors or supervisory board of another company on, the other company. A “group relationship” includes relationships between Portuguese companies where one is 100% owned or controlled, directly or indirectly, by the other or between companies that are bound by a group agreement or a subordination agreement whereby one company is subject to the instructions or management of the other.

In the absence of a controlling or a group relationship, the validity of a guarantee/security interest could be challenged if there is no justified own interest (*justificado interesse próprio*).

Further to this general legal restriction, additional limitations are imposed by specific laws, such as the prohibition to exercise a financial activity without a specific authorization or the limitation on financial assistance to shareholders or third parties, under the article 322 of the Companies Code, whereby the guarantee or security interest provided by a Portuguese company cannot be extended to cover any indebtedness used to fund, directly or indirectly, the acquisition or subscription of the share capital of such Portuguese company or its parent company (or, if applicable, in any other company which may indirectly control the Portuguese company).

2. Limitations imposed by the articles of association.

The provision of guarantees or security interest by a company must be within the limits of the corporate purpose clause of its articles of association.

Should the provision of a guarantee or security by a Portuguese company be considered to exceed the corporate purpose as expressed in the articles of association, the company is still bound by such action, unless there is evidence that the beneficiary of such acts knew that the acts exceeded the corporate purpose or that the beneficiary could not, in light of the circumstances, have been unaware of that fact.

Corporate authority

When a Portuguese Company grants guarantees/security interests, applicable corporate procedures normally entail that the decision be approved by a board resolution and/or by a shareholders meeting resolution and, where applicable, that the own interest (*interesse próprio*) of the Portuguese Company be justified in such resolution(s).

Public policy

The guarantee/security interest or any of its provisions could be held unenforceable, if it is deemed to be contrary to public policy (*ordem pública*).

Limitation language

The granting of guarantee/security interest in breach of capacity and financial assistance rules could entail criminal and civil liability incurred by the directors or managers of the Portuguese Company.

As a result, the guarantees and collateral (in particular, upstream and cross stream) granted by a Portuguese Company are subject to certain limitations, which usually take the form of a general limitation language, which is inserted in the relevant transaction document(s) (which will be included in the supplemental indentures executed by the Portuguese Companies), and which covers the maximum aggregate obligations and exposure of the relevant Portuguese Company

under the transaction documents and excludes any obligations that may be deemed to constitute financial assistance pursuant to article 322 of the Portuguese Companies Code and/or a breach of the restrictions on capacity set out in article 6(3) of the Companies Code.

Security interests considerations

Governing law

According to Portuguese conflict of law rules, the courts in Portugal will generally apply the *lex rei sitae* or *lex situs* (the law of the place where the assets or subject matter of the pledge or security interest is situated) in relation to the creation, perfection and enforcement of security interests over such assets. As a consequence, Portuguese law will apply in relation to the creation, perfection and enforcement of security interests over assets located or deemed to be located in Portugal, such as registered shares in Portuguese companies, bank accounts held with a bank or branch (*sucursal*) in Portugal, receivables/claims governed by Portuguese law and/or having debtors located in Portugal, movable assets located in Portugal, securities which are held through a securities account located in Portugal, bearer securities physically located in Portugal, etc.

If there are assets located or deemed to be located in Portugal, the security interests over such assets will be governed by Portuguese law and must be created, perfected and enforced in accordance with Portuguese law.

Perfection

Under Portuguese law, the perfection of security interests depends on certain registration, notification and/or acceptance requirements. As examples: (a) the pledge of nominative shares represented by certificates must be (i) notified to, or acknowledged by, the company which has issued the shares, (ii) endorsed in the shares certificates and (iii) registered in the shareholders' register of such company; (b) the receivables pledge becomes enforceable against the debtor after it has been notified to, or acknowledged by, the debtor; (c) the bank account pledge becomes effective against the banks after having been notified to, or acknowledged by, the banks; and (d) the mortgages over real estate must be registered with the Real Estate Registry Office.

Enforcement methods

In the case of a share pledge, bank account pledge and receivable pledge or assignment as security, the enforcement methods which are generally considered more suitable are (i) private sale (*venda extrajudicial*), (ii) foreclosure (*apropriação*) in case of financial pledges and/or (iii) disposal of collateral assigned as security (*venda executiva*). The private sale and foreclosure are only allowed if the security agreement so provides. The foreclosure is permitted for financial pledges over securities and cash deposits and provided that the parties agree the valuation method. In case of non financial pledges, the foreclosure must be carried out at the price determined by a court of law. Court enforcement is also possible but is usually considered to be lengthier and could prejudice the recovery of the claims.

Rights of third parties

The perfection of the security interests created pursuant to the pledge agreements does not prevent any third party creditor from seeking attachment or execution against the assets, which are subject to the security interests created under the pledge agreements, to satisfy their unpaid claims against the pledgor. A third party creditor may seek the forced sale of the assets of the pledgor which are subject to such security through court proceedings, although the beneficiaries under the relevant pledge or security documents will remain entitled to priority over the proceeds of such sale. In this case, the beneficiaries under the relevant pledge or security documents have to timely claim their credits ("*reclamação de créditos*") within the scope of the court proceedings initiated by the third parties creditors.

Language

Portuguese law documents may be executed in English. However, in case of enforcement the Portuguese courts or any other official Portuguese authority may require that the transaction documents and any judgment obtained in a foreign court be translated into Portuguese.

Insolvency

The ability of the Noteholders to enforce, secure and realize their rights under guarantees or security interests granted by a Portuguese Company may be delayed, restricted, subordinated, completely terminated or otherwise adversely affected in any insolvency proceedings conducted under Portuguese jurisdiction or subject to Portuguese law. The following

factors, among others, may adversely affect rights of secured creditors generally and in insolvency proceedings particularly:

- *Voidability of prejudicial transactions.* Under Decree Law 53/2004 of 18 March 2004, as last amended by Law 66—B/2012 of 31 December 2012 (the “Portuguese Insolvency Code”), any transfer of assets, granting of guarantees or creation of security interests by a Portuguese Company may be terminated by the insolvency administrator irrespective of any other conditions in an insolvency proceeding of the Portuguese Company (the “Presumed Prejudicial Transactions”) if, *inter alia*, (i) the guarantee is granted in the six months prior to the initiation of the insolvency proceeding and is related with transactions which are not in the best interest of the Portuguese Company, (ii) the security interest is given in respect of existing obligations or new obligations replacing such existing obligations within six months prior to the initiation of the insolvency proceedings, (iii) the security interest is granted simultaneously with the creation of the secured obligations if they are undertaken in the sixty days prior to the initiation of the insolvency proceedings or (iv) the agreements are executed against consideration during the year before the insolvency petition is filed and the obligations of the Portuguese Company are deemed excessive when compared with those of the counterparty.
- *Voidability of other transactions.* In addition to the Presumed Prejudicial Transactions described above, the insolvency administrator may also terminate any transactions entered upon by the Portuguese Company during the two years prior to the initiation of the insolvency proceedings, which cause the reduction, place at risk, or which postpone the exercise of the creditors’ rights and are entered into in bad faith by the counterparty. Bad faith will be deemed to exist if the beneficiaries knew, at the time the security or guarantee was given, that (i) the Portuguese Company was insolvent, (ii) the granting of the security would be prejudicial and that the insolvency was imminent and (iii) the insolvency proceedings had already been initiated. Bad faith is presumed to exist in relation to any transaction entered upon with or benefiting a related entity in the two years before the initiation of the insolvency proceedings irrespective of whether such relation existed or not on the date the transaction was entered upon.
- *The issuance of an insolvency order by a court of competent authority in respect of a company results in a stay of proceedings.* The insolvency order creates a stay on all enforcement actions pending against the debtor. After the issuance of the insolvency order, the administration and disposal of assets will be decided by a court appointed administrator.
- Claims and rights of creditors of a company in insolvency proceedings may abate in whole or in part due to insufficient funds and assets of the company in insolvency. Under the Portuguese Insolvency Code higher ranking creditors of a certain class will be permitted to satisfy their interests prior to creditors of lower rankings, and creditors of the same class will have a pro rata right to secure and satisfy their interest with other creditors of the same class. Creditors holding a pledge or charge in relation to the insolvent’s assets rank higher in priority to shareholders and other unsecured creditors of a company. Such creditors are entitled to receive the proceeds from the disposal of the pledged asset to satisfy their claim but will be treated as unsecured creditors with respect to any portion thereof not entirely satisfied by the proceeds received from the disposal of the pledge if such proceeds are insufficient to repay their entire claim. Creditors holding a pledge or charge may, however, be only be paid after (i) the debts of the insolvent company incurred during the insolvency proceedings, the court fees and other costs concerning the proceeding, subject to certain requirements and limits, (ii) the debts of creditors statutorily preferred under Portuguese law (e.g. tax authorities holding a lien in respect of taxes owed and not paid on real estate property of the company) and (iii) the debts of certain creditors holding statutory liens (e.g. employees).

France

Limitations on guarantees

Corporate benefit, financial assistance and other limitations

As described in “*Corporate and Financing Structure*”, certain guarantees and securities have been granted by companies incorporated in France, and security has been granted over assets located in France.

In certain circumstances, where a French company acts in breach of its requirement to act for its corporate benefit, its officers may incur civil and/or criminal liability. In addition, under French law, a French court may, under certain circumstances, set aside a guarantee granted by a French company if such company derives no corporate benefit.

While the granting of guarantees by a parent company with respect to the obligations of its subsidiary are deemed to be, in principle, for the corporate benefit of the parent company, the granting of cross or upstream guarantees by a subsidiary may be more problematic from that perspective.

Furthermore, under French financial assistance rules, a company limited by shares may not advance funds, grant loans or grant security for the purposes of the subscription or the acquisition of its own shares by a third party. Breach of French financial assistance rules may result in criminal liability for the officers of the company acting in breach of these rules and their accomplices.

Based upon the above, guarantee limitation language has been agreed in this transaction with respect to the Guarantees to be granted by Guarantors incorporated under the laws of France (each, a “**French Guarantor**”) in respect of the payment obligations of the Issuers under the New Notes:

- the obligations and liabilities of a French Guarantor under its Guarantee will not include any obligation or liability which, if incurred, would constitute the provision of financial assistance within the meaning of Article L.225-216 of the French Commercial Code or any other laws having the same effect and/or would constitute a misuse of corporate assets or corporate credit within the meaning of Articles L.241-3, L. 242-6 or L.244-1 of the French Commercial Code; and
- the obligations and liabilities of a French company under its Guarantee for the obligations of any Issuer under the New Notes shall be limited, at any time, to an amount equal to the aggregate of the proceeds of the New Notes to the extent directly or indirectly on lent by such Issuer to that French Guarantor or any of its subsidiaries under intercompany loans or similar arrangements and be limited to the amount outstanding, if any, at the time a demand is made from such French Guarantor under its Guarantee; it being specified that:
 - any payment made by such French Guarantor under its Guarantee in respect of the obligations of any other obligor shall reduce pro tanto the outstanding amount of the intercompany loans (if any) due by such French Guarantor to that obligor under the intercompany loan arrangements referred to above;
 - any payment made by such French Guarantor under the Guarantee and Indemnity provisions of the 2013 Term Loan, the 2013 Revolving Credit Facility and the Existing Senior Notes in respect of the obligations of any other obligor shall (without double counting) reduce pro tanto the outstanding amount of the intercompany loans (if any) due by such French Guarantor to that obligor under the intercompany loan arrangements referred to above.

However, the balance of such inter company loans, which are financed directly or indirectly with the proceeds of the New Notes, will increase and decrease in the ordinary course of business, in line with the needs of the business and availability of such proceeds for other utilizations.

A French insolvency court may also refuse to enforce a guarantee if it is determined that the grantor was insolvent at the time the guarantee was granted and that the relevant secured party had knowledge, at the time the guarantee was granted, of such insolvency.

Grace periods

A French court may, pursuant to Articles 1244-1 *et seq.* of the French Civil Code, in any civil proceedings involving a debtor, whether initiated by the debtor or its creditor, taking into account the debtor’s financial position and the creditor’s financial needs, defer or otherwise reschedule the payment dates of payment obligations over a maximum period of two years and decide that any amounts, the payment date of which is thus deferred or rescheduled, will bear interest at a rate which is lower than the contractual rate (but not lower than the relevant legal rate as published by decree) or that payments made shall first be allocated to repayment of the principal. If a court order under article 1244-1 of the French Civil Code is made, it will suspend any pending enforcement measures that may have been initiated by the creditors, and any contractual interest or penalty for late payment will not accrue or be due during the grace period ordered by the court. A creditor cannot contract out of such grace periods.

French insolvency laws

In general, French insolvency legislation favors the continuation of a business and protection of employment over the payment of creditors. Consequently, the commencement of pre-insolvency or insolvency proceedings at the level of a company which has provided security and/or a guarantee in respect of the New Notes may limit the ability of holders of the New Notes to enforce a guarantee and/or security granted by such company in relation to the New Notes.

Under Council Regulation (EC) No.1346/2000 of 29 May 2000 on insolvency proceedings, French courts may have jurisdiction over the main insolvency proceedings of a company incorporated in the jurisdiction of another EU Member State if the center of main interests of such company is deemed to be in France. In determining whether the center of main interests of a company is in France, French courts will take into account a broad range of factual elements.

The following is a general discussion of insolvency proceedings governed by French law for informational purposes only and does not address all the French legal considerations that may be relevant to holders of the New Notes in this respect.

Insolvency (cessation des paiements) under French law

Under French law, a company is deemed insolvent (*en cessation des paiements*) when it is not able to pay its debts which are due with its available assets taking into account credit lines available to it, and debt rescheduling which its creditors have granted to it.

Warning procedure (procédure d'alerte)

In order to anticipate a debtor's difficulties to the extent possible, French law provides for warning procedures. Indeed, when there are elements which they believe put the company's existence as a going concern in jeopardy, the statutory auditors of a company can request the management to provide an explanation. Failing satisfactory explanations or corrective measures, the auditors can request that a board of directors (or the equivalent body), and, at a later stage, the shareholders' meeting be convened. Depending on the answers provided to them (and the type of company), the auditors can or must inform the President of the relevant Commercial Court of the warning procedure.

Shareholders representing at least 5% of the share capital and the workers' committee (or, in their absence, the employees' representatives) have similar rights.

The President of the relevant Commercial Court can also himself summon the management to provide explanations on elements which the President of the court believes put the company's existence as a going concern in jeopardy (or when the company has not filed its financial statements within the statutory timeframe, despite his injunction).

Court-assisted pre-insolvency proceedings

A company that has its center of main interests in France and faces difficulties may request the commencement of court-assisted pre-insolvency proceedings (*mandat ad hoc* or *conciliation*), the aim of which is to reach an agreement with the debtor's main creditors and stakeholders under the aegis of a third party moderator (*mandataire ad hoc* or *conciliateur*), whose name can be suggested by the debtor, appointed by the President of the relevant court (usually the Commercial Court). These proceedings are amicable, confidential (subject to the details below as regards conciliation proceedings) and do not involve any automatic stay.

Mandat ad hoc proceedings

French law does not provide for any specific rule in respect of *mandat ad hoc*. In practice, *mandat ad hoc* proceedings are used by debtors that are facing difficulties of an economic, legal or financial nature but are not insolvent. The *mandataire ad hoc*'s duties are determined by the relevant court. This *mandataire ad hoc* is usually appointed in order to facilitate the negotiations with the debtor's main creditors or stakeholders but he cannot coerce the creditors to accept any proposal and the dissenting creditors will not be bound by the arrangement, if any. Creditors are not barred from taking legal action against the company to recover their claims, but, in practice, they generally abstain from doing so. *Mandat ad hoc* proceedings are confidential and are not limited in time. The agreement reached by the parties (if any) with the help of the *mandataire ad hoc* can be reported by the latter to the President of the court but is not sanctioned by the court or the President of the court.

In any event, the debtor retains the right to petition the relevant judge for a grace period as set forth in Article 1244-1 *et seq.* of the French Civil Code (see "*France—Limitations on guarantees—Grace periods*").

Conciliation proceedings

Conciliation proceedings are available to a debtor that faces actual or foreseeable difficulties of a legal, economic or financial nature but which is not insolvent or has not been insolvent for more than 45 days. The debtor petitions the President of the Commercial Court for the appointment of a conciliator in charge of assisting the debtor in negotiating an agreement with all or part of its creditors and stakeholders. *Conciliation* proceedings are confidential (subject to the below) and may last up to five months. During the proceedings, creditors may continue to individually claim payment of their claims. However, if, during the *conciliation* proceedings, a creditor initiates a legal action against the debtor or gives the debtor formal notice to pay, the debtor retains the right to petition the President of the Court for debt rescheduling for a maximum of two years pursuant to article 1244-1 *et seq.* of the French Civil Code (see "*France—Limitations on guarantees—Grace periods*"). In that case, the President of the Court who commenced the *conciliation* proceedings has jurisdiction and will take his/her decision after having been informed by the conciliator (*conciliateur*).

Upon its execution, the agreement reached by the parties becomes binding upon them and creditors party thereto may not take action against the company in respect of claims governed by the agreement. In addition, without such formalities being an obligation on the parties, the agreement can be either:

- upon all parties' request, acknowledged (*constaté*) by the President of the court, which makes it immediately enforceable. The acknowledgement of the conciliation agreement keeps the conciliation proceedings confidential; or
- upon the debtor's request, sanctioned (*homologué*) by a decision of the court, subject to the satisfaction of certain conditions (*i.e.*: (i) the debtor is not insolvent or the conciliation agreement puts an end to the debtor's insolvency; (ii) the conciliation agreement effectively ensures that the company will survive as a going concern; and (iii) the agreement does not infringe upon the rights of the non-signatory creditors). The judgment will make the conciliation proceedings public only in respect of the existence of the conciliation proceedings but not in respect of the content of the agreement (except for the guarantees and security interests as well as the amount of "new money" detailed below, as provided for in the agreement) which shall have the following specific consequences:
- creditors who provide new money, goods or services designed to ensure the continuation of the business of the distressed company (other than shareholders providing new equity) will enjoy a priority of payment over all pre-petition and post-petition claims (other than certain pre-petition employment claims and procedural costs), in the event of subsequent safeguard (including the accelerated safeguard proceedings and the accelerated financial safeguard proceedings referred to below) proceedings, judicial reorganization proceedings or judicial liquidation proceedings; and
- in the event of subsequent judicial reorganization proceedings or judicial liquidation proceedings, the date of insolvency (*cessation de paiements*) and therefore the starting date of the so-called suspect period (as defined below) cannot be set by the court at a date earlier than the date of the sanction of the agreement by the court, except in the case of fraud (see the definition of the date of the *cessation des paiements* above).

Joint debtors, personal guarantors, or any third party that granted a security interest can benefit from the provisions of the sanctioned or acknowledged agreement. Provided the agreement (whether acknowledged, sanctioned or not) is duly executed, any individual proceedings by creditors with respect to the claims included in the agreement are suspended.

In case of breach of the agreement, any party thereto can petition the court for its termination. The commencement of subsequent insolvency proceedings will automatically put an end to the conciliation agreement, in which case the creditors will recover their claims and security interests, except for those amounts already paid to them. In any event, the debtor retains the right to petition for debt rescheduling pursuant to article 1244-1 *et seq.* of the French Civil Code (see "*France—Limitations on guarantees and security interests—Grace periods*").

Conciliation proceedings, in the context of which a draft plan has been negotiated and is supported by a large majority of creditors without reaching unanimity, will be a mandatory preliminary step of the accelerated financial safeguard proceedings and accelerated safeguard proceedings as described below.

Court-administered insolvency proceedings—safeguard, accelerated safeguard, accelerated financial safeguard, reorganization and liquidation proceedings

Court-administered insolvency proceedings may be initiated:

- in the event of safeguard, accelerated safeguard or accelerated financial safeguard proceedings, upon petition by the debtor only; and
- in the event of judicial reorganization or liquidation, upon petition by the debtor, any creditor or the public prosecutor. The debtor may file for safeguard proceedings at any time it is facing difficulties that it cannot overcome, as long as it is not insolvent. It is required to petition for the commencement of judicial reorganization proceedings (if recovery is possible) or judicial liquidation proceedings (if recovery is manifestly not possible) within 45 days of it becoming insolvent (unless it filed for conciliation proceedings in the meantime). If it fails to do so, its directors and officers may incur civil liability.

The period from the date of the court decision commencing the proceedings (whether a safeguard or a judicial reorganization) to the date on which the court takes a decision on the outcome of the proceedings is called the observation period and may last up to 18 months. During the observation period, a court-appointed administrator, whose name can be suggested by the debtor in safeguard proceedings, investigates the business of the company. Creditors do not have effective control over the procedure, which remains in the hands of the company and the administrator and is overseen by the court. In safeguard proceedings, the administrator's mission is limited to either supervising or assisting the debtor's management and assisting it in preparing a safeguard plan for the company. In judicial reorganization

proceedings, the administrator's mission is usually to assist the management and to make proposals for the reorganization of the company, which proposals may include a business continuation plan (equivalent to a safeguard plan) and/or the sale of all or part of the company's business to a third party. In judicial reorganization, the court may also decide that the administrator will manage the company alone in lieu of the debtor's management.

At the end of the observation period, if it considers that the company can survive as a going concern, the court will adopt a safeguard or reorganization plan which will essentially entail a restructuring and/or rescheduling of debts and may entail the divestiture of some or all of the debtor's assets and businesses (a sale of the entire business is not possible in a safeguard plan). At any time during safeguard proceedings, the court may convert at its own initiative such proceedings into reorganization proceedings if the debtor becomes insolvent or at the debtor's request, if the approval of a safeguard plan is manifestly impossible and if the company would become insolvent should safeguard proceedings end. At any time during safeguard or reorganization proceedings, the court may also convert such proceedings into liquidation proceedings if the debtor is insolvent and its recovery is manifestly impossible.

Creditors' committees and adoption of the safeguard or reorganization plan

During the observation period, in the case of large companies (with more than 150 employees or turnover greater than €20 million) or where authorized by the supervising judge for smaller companies, two creditors' committees (one for credit institutions having a claim against the debtor or entities having granted credit or advances in favor of the debtor and the other for suppliers having a claim that represents more than 3% of the total amount of the claims of all the debtor's suppliers—the smaller suppliers, if invited by the administrator, may elect to be members of such committee) have to be established. To be eligible to vote, suppliers must have their claims set forth in the list provided by the debtor to the judicial administrator as certified by the debtor's statutory auditor (or, in its absence, its accountant).

If there are any outstanding debt securities in the form of *obligations* (such as bonds or notes), a general meeting gathering all holders of such debt securities will be established irrespective of whether or not there are different issuances and of the governing law of those *obligations* (the "bondholders' general meeting"). The New Notes would constitute *obligations* for the purposes of a safeguard or reorganization proceedings and the Noteholders would therefore vote within the bondholders' general meeting.

These two committees and the bondholders' general meeting will be consulted on the safeguard or reorganization plan drafted by the debtor's management, together with the judicial administrator, during the observation period.

The draft plan submitted to the committees and the bondholders:

- must take into account subordination agreements entered into by the creditors before the commencement of the proceedings;
- may treat creditors differently if it is justified by their differences in situation; and
- may in particular include a rescheduling or cancellation of debts and debt-for-equity swaps (debt-for-equity swaps requiring the relevant shareholder consent).

Creditors which are members of the credit institutions' committee or the suppliers' committee may prepare an alternative safeguard or reorganization plan that will also be put to the vote of the committees and of the general bondholders meeting, it being specified that approval of these alternative plans is subject to the same two-thirds majority vote in each committee and in the bondholders general meeting and gives rise to a report by the judicial administrator). Bondholders are not permitted to present their own alternative plan.

In the first instance, the plan must be approved by each of the two creditors' committees. Each committee must announce whether its members approve or reject such plan within 20 to 30 days of its proposal to the debtor (such time can be reduced or extended by the supervising judge, at the request of the debtor or the judicial administrator, it being noted that it cannot last less than 15 days). Such approval requires the affirmative vote of creditors holding at least two-thirds of the amounts of the claims held by the members of such committee that express a vote.

Following the approval of the plan by the two creditors' committees, the plan will be submitted for approval to the bondholders' general meeting. The approval of the plan at such meeting requires the affirmative vote of bondholders representing at least two-thirds of the amount of the claims held by bondholders expressing a vote in the bondholders' general meeting.

Creditors for whom the plan does not provide any modification of their repayment schedule or provides for a payment of their claims in cash in full as soon as the plan is adopted or as soon as their claims are admitted do not take part in the

vote. For those creditors outside such committees or where no such committees have been convened, the creditors' representative may elect not to consult them.

Following approval by the creditors' committees and the bondholders' general meeting (and approval by each creditor that is not a member of the committees or a bondholder of a proposal, including in particular a rescheduling or a cancellation of part of its debt), the plan has to be approved by the court. In considering such approval, the court has to verify that the interests of all creditors are sufficiently protected. Once approved by the relevant court, the safeguard or reorganization plan accepted by the committees and the bondholders' general meeting will be binding on all the members of the committees and all bondholders (including those who did not vote or voted against the adoption of the plan), as well as those creditors outside such committees/general meeting (it being noted that they can only have imposed upon them debt rescheduling by the court as detailed below).

In the event any of the committees or the bondholders' general meeting has refused to give its consent to the plan (or has not rendered its decision within 6 months of the judgment commencing the proceedings), the plan will not be approved by the court, which can still adopt a safeguard plan in the time remaining until the end of the observation period, in which case a consultation of the creditors on an individual basis will take place. They will be asked whether they accept rescheduling, cancellation of debt and/or debt- for-equity swaps provided for in the draft plan. Where the consultation is in writing, the creditor is deemed to have accepted the debt rescheduling and/or write-offs proposal if he fails to respond within thirty days upon receipt of the creditors' representative's letter. However, with respect to debt-to-equity swap proposals, the creditors' representative must obtain the agreement of each individual creditor in writing within this 30-day timeframe.

In such circumstances, for those individual creditors who have not reached a negotiated agreement, the court can only impose uniform debt deferrals over a maximum period of 10 years, except for claims with maturity dates of more than 10 years, in which case the maturity date shall remain the same. The court cannot impose on them debt write-offs or debt-to-equity swaps. The same rule applies with respect to creditors who are not members of the committees, or where no such committees or general meeting of bondholders are convened.

The first payment must be made within a year of the judgment adopting the plan (as from the third year included, the minimum annual installment is 5% of the total admitted liabilities), it being noted, however, that if the contractual provisions relating to a debt claim provide that the principal amount of such debt claim is repayable *in fine* and its maturity date falls within the implementation period of the plan, the repayment of such principal amount only starts on the first annual installment date (as set out in the plan) following the original contractual maturity date of that debt claim and such payment follows specific rules.

Court-administered proceedings—accelerated safeguard and accelerated financial safeguard proceedings

A debtor in conciliation proceedings may request commencement of accelerated safeguard proceedings. Accelerated financial proceedings are very similar to safeguard proceedings (see above) but have been designed to “fast-track” difficulties of large companies:

- (1) who publish consolidated accounts; or
- (2) who publish accounts certified by an auditor or established by an independent accountant and have (i) more than 20 employees or (ii) a turnover greater than €3 million or (iii) whose total balance sheet exceeds €1.5 million.

There are two sub-categories of accelerated safeguard procedures.

The first of these are accelerated safeguard proceedings which apply to all classes of creditors.

Accelerated financial proceedings apply only to debt owed to financial institutions and bondholders (*i.e.*, debts towards creditors eligible to be part of the credit institutions' committee and bond debts) the payment of which is to be affected by the plan adopted through accelerated financial safeguard proceedings, other debts continuing to be paid in the ordinary course of business (*e.g.* trade debt or debt to the tax or social security administrations) in accordance with their contractual or legal terms.

Other creditors, such as public creditors (*e.g.* the tax or social security administration) or suppliers, are not directly impacted by accelerated financial safeguard proceedings. Their debt continues to be due and payable according to their contractual or legal terms. The list of claims of credit institutions and bondholders party to the conciliation proceedings shall be drawn up by the debtor and certified by the statutory auditor and shall be deemed to constitute the filing of such claims (see below) unless the creditors otherwise elect to make such a filing (see below). If the relevant conditions are met, all creditors may be subject to an accelerated safeguard procedure.

To be eligible to accelerated safeguard and accelerated financial safeguard proceedings, the debtor must fulfill three conditions:

- as is the case for regular safeguard proceedings, the debtor must (i) not be insolvent and (ii) face difficulties which it is not able to overcome;
- the debtor must be subject to ongoing *conciliation* proceedings when it applies for the commencement of the accelerated safeguard or accelerated financial safeguard proceedings;
- the debtor must have prepared a draft safeguard plan ensuring the continuation of his business as a going concern supported by enough of its creditors to render likely its adoption by a two-thirds majority of its financial creditors, within a maximum of three months of the commencement of the proceedings in the case of accelerated safeguard proceedings and of one month following the commencement of the proceedings in the case of accelerated financial safeguard proceedings (that can be extended by an additional month).

If a plan is not adopted by the creditors and approved by the court within such deadlines, the court shall terminate the proceedings. The court cannot reschedule amounts owed to the creditors outside of the committee process.

Where accelerated financial safeguard proceedings are commenced, the credit institutions' committee and the bondholders' general meeting are convened and are required to vote on the proposed safeguard plan within a minimum period of eight days of delivery of the proposed plan (as compared to a minimum period of 15 days for regular safeguard proceedings as described above).

The total duration of the accelerated safeguard proceedings (*i.e.*, the period between the judgment commencing accelerated financial safeguard proceedings and the judgment adopting the plan) is three months and of the accelerated financial safeguard proceedings is one month (which can be extended by an additional month).

Status of creditors during safeguard, accelerated safeguard, accelerated financial safeguard, judicial reorganization or judicial liquidation proceedings

Contractual provisions pursuant to which the commencement of the proceedings constitutes an event of default are not enforceable against the debtor, while the judicial administrator can unilaterally request the termination of ongoing contracts (*contrats en cours*) which it believes the debtor will not be able to continue to perform. The judicial administrator can, on the contrary, require that other parties to a contract continue to perform their obligations even though the debtor may have been in default, but on the condition that it fully performs its post-petition contractual obligations.

In addition, during the observation period:

- accrual of interest is suspended (except in respect of loans providing for a term of at least one year, or contracts providing for a payment which is deferred by at least one year);
- the debtor is prohibited from paying debts incurred prior to the date of the court decision commencing the proceedings, subject to specified exceptions which essentially cover the set-off of related (*connexes*) debts and payments authorized by the insolvency judge to recover assets for which recovery is justified by the continued operation of the business; and
- creditors may not pursue any individual legal action against the debtor (or, in safeguard or reorganization proceedings, against a guarantor of the debtor provided such guarantor is an individual) with respect to any claim arising prior to the court decision commencing the proceedings if the objective of such legal action is:
 - to obtain an order for payment of a sum of money by the debtor to the creditor (however, the creditor may require that a court determine the amount due);
 - to terminate a contract for non-payment of pre-petition amounts owed to the creditor; or
 - to enforce the creditor's rights against any assets of the debtor, except where such asset—whether tangible or intangible, moveable or immovable—is located in another Member State within the European Union, in which case the rights in rem of creditors thereon would not be affected by the insolvency procedure, in accordance with the terms of Article 5 of EC Regulations 1346/2000).

As a general rule, creditors domiciled in France whose claims arose prior to the commencement of proceedings must file their claims with the creditors' representative (*mandataire judiciaire*) within two months of the publication of the court decision in an official gazette (*Bulletin Officiel des annonces civiles et commerciales*) (provided that the deadline starts upon receipt of an individual notification for those creditors whose claim arose out of a published contract or who benefit from a published security interest); this period is extended to four months for creditors domiciled outside France. Creditors who have not submitted their claims during the relevant period are, except with respect to very limited exceptions, barred from receiving distributions made in connection with the plans sanctioned by the court. Employees are not subject to limitations and are preferred creditors under French law.

In accelerated safeguard proceedings, a simplified process is applicable to creditors that took part in the conciliation proceedings.

If the court adopts a safeguard plan or reorganization plan, claims of creditors included in the plan will be paid according to the terms of the plan. The court can also set a time period during which the assets that it deems to be essential to the continued business of the debtor may not be sold without its consent.

In case of judicial reorganization or liquidation with a continuation of the business, if the court adopts a plan for the sale of the business (*plan de cession*), the proceeds of the sale will be allocated for the repayment of the creditors according to the ranking of the claims. If the court decides to order the judicial liquidation of the debtor, the court will appoint a liquidator in charge of selling the assets of the company and settling the relevant debts in accordance with their ranking. However, in practice, where a plan for the sale of the business is considered, it will usually appoint a judicial administrator to manage the company and organize such sale of the business process.

French insolvency law assigns priority to the payment of certain preferred creditors, including employees, post-petition legal costs (essentially fees of the officials appointed by the insolvency court), creditors who, as part of a sanctioned conciliation agreement, have provided new money or goods or services, certain pre-petition secured creditors in judicial liquidation proceedings only, post-petition creditors, the French State (taxes and social charges), other pre-petition secured creditors and pre-petition unsecured creditors.

Judicial reorganization or liquidation proceedings

Judicial reorganization or liquidation proceedings (*redressement or liquidation judiciaire*) are open to insolvent debtors, whose recovery prospects are respectively possible or manifestly impossible. They may be initiated upon petition by the debtor or any creditor or the public prosecutor. The company is required to petition for such insolvency proceedings (or for conciliation proceedings as discussed above) within 45 days of becoming insolvent. If it does not, *de jure* managers (including directors) and, as the case may be, *de facto* managers may be subject to civil liability.

The date of insolvency is generally deemed to be the date of the court ruling commencing proceedings, unless the court sets an earlier date, which may be carried back up to 18 months before the date of such ruling. Except for fraud, the date of insolvency may not be set at an earlier date than the date of the final court decision which sanctioned (*homologué*) the conciliation agreement in the context of a conciliation procedure. The period of time starting on such date of insolvency and ending on the date of such ruling is named the "suspect period" ("*période suspecte*"). Certain transactions undertaken during the so-called suspect period may become automatically void or voidable as detailed in the next section.

Where the debtor requested the commencement of judicial reorganization proceedings and the court considers that judicial liquidation proceedings would be more appropriate, after having heard the debtor, the court may order the commencement of the proceedings which it finds most appropriate. The same would apply if the debtor requested the commencement of judicial liquidation proceedings and the court considers that judicial reorganization proceedings would be more appropriate.

In addition, at any time during the safeguard proceedings observation period, upon request of the debtor, the administrator, the creditors' representative (*mandataire judiciaire*), the public prosecutor or (at its own initiative) the court may convert safeguard proceedings into reorganization proceedings or liquidation proceedings. In all cases, the court's decision is only taken after having heard the debtor, the judicial administrator, the creditors' representative, the public prosecutor and the workers' representatives (if any).

In the event of a judicial reorganization, an administrator is appointed by the court to assist the debtor to make management decisions (*mission d'assistance*) or may be empowered by the court to take over the management and control of the debtor (*mission d'administration*) (see the court-administered insolvency proceedings section above for the description of the observation period and the Creditors' Committees and Adoption of the Safeguard or Reorganization Plan section for the consultation of the creditors on the draft reorganization plan). At the end of the observation period, the outcome of the proceedings is decided by the court.

In the event of reorganization, an administrator is usually appointed by the court (*administrateur judiciaire*) to investigate the business of the debtor during an observation period, which may last up to 18 months, and make proposals either for the reorganization of the debtor (by helping the debtor to elaborate a reorganization plan, which is similar to a safeguard plan), or the sale of the business or the liquidation of the debtor.

There is no observation period in case of judicial liquidation proceedings being commenced against the debtor. The outcome of these proceedings, which is decided by the court without a vote of the creditors, may be a plan for the sale of the business and/or isolated sales of the debtor's assets in order to discharge the debtor's liabilities. In case a plan for the sale of the business is considered, the court can authorize a temporary continuation of the business for a maximum period of three months (renewable once at the public prosecutor's request), the effects of which are similar to an observation period.

The "Suspect Period" in judicial reorganization and liquidation proceedings

The court determines the date on which insolvency is deemed to have occurred. It can be any date within the 18 months preceding the date of the commencement of the proceedings. This marks the beginning of the so-called suspect period. Certain transactions entered into by the debtor during such suspect period are automatically void or voidable by the court.

Automatically void transactions include transactions or payments entered into during the so-called suspect period that may constitute voluntary preferences for the benefit of some creditors to the detriment of other creditors. These include transfers of assets for no consideration, contracts under which the reciprocal obligations of the debtor significantly exceed those of the other party, payments of debts not due at the time of payment, payments made in a manner which is not commonly used in the ordinary course of business and security granted for debts (including a security granted to secure a guarantee obligation) previously incurred and provisional measures, unless the right of attachment or seizure predates the date of insolvency (*cessation de paiements*), the transfer of any assets or rights to a trust arrangement (*fiducie*) (unless such transfer is made as a security for debt incurred at the same time), and any amendment to a trust arrangement (*fiducie*) that dedicates assets or rights as a guarantee of pre-existing debts.

Transactions voidable by the court include payments made on accrued debts, transactions for consideration and notices of attachments made to third parties (*avis à tiers détenteur*), seizures (*saisie attribution*) and oppositions made during the so-called suspect period, if the court determines that the creditor knew of the insolvency (*cessation de paiements*) of the debtor. Transactions relating to the transfer of assets for no consideration are also voidable when entered into during the six-month period prior to the beginning of the so-called suspect period (see "*Fraudulent Conveyance*").

There is no suspect period prior to the commencement of safeguard or accelerated safeguard proceedings, since the condition required to commence such proceedings is that the company is not insolvent within the meaning of French law.

Fraudulent Conveyance

French law contains specific provisions dealing with fraudulent conveyance both in and outside of insolvency proceedings, the so-called *action paulienne* provisions. The *action paulienne* offers creditors protection against a decrease in their means of recovery. A legal act performed by a person (including, without limitation, an agreement pursuant to which it guarantees the performance of the obligations of a third party or agrees to provide or provides security for any of its or a third party's obligations, enters into additional agreements benefiting from existing security and any other legal act having similar effect) can be challenged in or outside insolvency proceedings of the relevant person by the creditors' representative (*mandataire judiciaire*), the commissioner of the safeguard or recovery plan (*commissaire à l'exécution du plan*) in insolvency proceedings of the relevant person or any creditor who was prejudiced in its means of recovery as a consequence of the act in or outside insolvency proceedings, and may be declared unenforceable against third parties if: (i) the person performed such acts without an obligation to do so; (ii) the creditor concerned or, in the case of the person's insolvency proceedings, any creditor, was prejudiced in its means of recovery as a consequence of the act; and (iii) at the time the act was performed both the person and the counterparty to the transaction knew or should have known that one or more of its creditors (existing or future) would be prejudiced in their means of recovery, unless the act was entered into for no consideration (*à titre gratuit*), in which case such knowledge of the counterparty is not necessary for a successful challenge on grounds of fraudulent conveyance. If a court found that the issuance of the New Notes or the granting of a guarantee involved a fraudulent conveyance that did not qualify for any defense under applicable law, then the issuance of the New Notes or the granting of such guarantee could be declared unenforceable against third parties or declared unenforceable against the creditor that lodged the claim in relation to the relevant act. As a result of such successful challenges, holders of the New Notes may not enjoy the benefit of the New Notes, the guarantees and the value of any consideration that holders of the New Notes received with respect to the New Notes or the guarantees could also be subject to recovery from the holders of the New Notes and, possibly, from subsequent transferees. In addition, under such circumstances, holders of the New Notes might be held liable for any damages incurred by prejudiced creditors of the Issuers as a result of the fraudulent conveyance.

Switzerland

The validity and the enforcement of a guarantee or security interest may be limited by applicable bankruptcy, insolvency, re-organization or similar laws, regulations or defenses affecting creditors and secured parties in general (including provisions relating to fraudulent transfer, voidable preference, corporate purpose, financial assistance, capital maintenance and solvency), international private laws (including *ordre public*) or laws or principles of general application (including but not limited to the abuse of rights (*Rechtsmissbrauch*), the principle of good faith (*Grundsatz von Treu und Glauben*) and public policy (including antitrust or merger control laws)).

Financial assistance rules

You may not be able to enforce, or recover any amounts under the guarantee/security interests granted by Green due to restrictions on enforcement reflecting Swiss corporate, tax and contract law.

Swiss corporate law does not recognize the overall legal concept of integrated company groups. Consequently directors and officers may not take a consolidated view and fulfill their fiduciary duties merely by considering the overall interests of the entire group and intra-group transactions not made at arm's length terms may be problematic.

Financial assistance by Green (or any other company incorporated in Switzerland which becomes a guarantor) in respect of obligations of its direct or indirect shareholder(s) ("upstream") or of related persons or entities of its shareholder(s) other than any direct or indirect subsidiaries ("cross stream") is subject to certain Swiss corporate law rules that may significantly impact the value of the guarantee/security interest. In particular, upstream and cross stream financial assistance must be within the corporate purpose and scope, as set forth in the articles of association, and interests of Green and may not entail a repayment of capital or a violation of legally protected reserves. In addition, the enforcement of the guarantee/security interest provided by Green may be treated as a profit distribution to shareholders and, therefore, must be unanimously approved by the board of directors and the shareholders of Green. Such financial assistance must be limited to the freely distributable reserves of Green, as to be measured by an auditor's report at the time of enforcement, whereby the report and the calculation of the freely distributable reserves available for profit distribution must take into account (by way of deducting) any upstream or cross-stream loans not granted at arm's length terms.

Payments under the guarantee/security interest provided by Green may be subject to the withholding tax at the current rate of 35% (or such other rate as in force from time to time), which, unless Green has entered into a specific agreement with the Swiss federal tax administration for a reduced rate of withholding, must be deducted from the gross payment. Swiss resident beneficial owners of such payments can claim full refund of the withholding tax on the basis of national law, provided the specific requirements are met. Non Swiss residents can claim full or partial refund of the withholding tax on the basis of an applicable double taxation treaty between the country of residence of the recipient and Switzerland, including the Savings Tax Agreement signed between Switzerland and the European Union on October 26, 2004 (SR 0.641.926.81, SR 0.641.926.811), which also covers dividends to EU parent companies, and the Treaty between the United States of America and Switzerland for the Avoidance of Double Taxation with Respect to Taxes on Income (SR 0.672.933.61), provided the specific requirements are met. The obligation of Green to gross up by paying additional amounts may not be enforceable under Swiss law.

Financial assistance rules are unsettled under Swiss law. There are very few court decisions available in this respect and the legal doctrine is divided. We can provide no assurances that future court rulings will not further restrict the enforceability, or deny the validity, of guarantees/security interests. Such rulings would negatively affect the ability to enforce the guarantee/security interest granted by Green. The granting of guarantees/security interest in breach of such financial assistance rules could result in the invalidity and non enforceability of such guarantees/security interests and could entail criminal and civil liability of the board of directors or other corporate bodies of Green. Thus, the guarantee/security interest granted by Green is subject to certain limitations, normally in the form of a general limitation language inserted into the relevant transaction documents and which are in line with the requirements set out hereinabove which in particular cover the maximum aggregate obligations and exposure of Green under the transaction documents.

Choice of law considerations

The guarantee by Green is, based on a choice of law, subject to the laws of the State of New York. Should a Swiss court accept jurisdiction in proceedings on the merits based on the laws applicable in Switzerland, a Swiss court will generally recognize the choice of law. The scope of such choice of law is, usually, limited to the rules of the substantive law chosen by the parties; as to procedural matters, a Swiss court will apply Swiss procedural law. Due to the different nature of Swiss procedural law and the procedural law in common law jurisdictions (such as the United States of America and the United Kingdom) classification and delimitation issues between substantive and procedural law could occur. To establish the non-Swiss substantive law applicable to the merits, a Swiss court may, in pecuniary matters, request the parties to establish the non-Swiss substantive law. If the content of the foreign substantive law cannot be established, then Swiss law may be applied. While a Swiss court will generally accept a choice of law, there still exist some exceptions: Swiss

courts may diverge from the chosen substantive law (i) if such chosen law leads to a result contrary to Swiss public policy, (ii) if the purpose of mandatory rules of Swiss law require, by their special aim, direct application, or (iii) if the purpose of mandatory rules of another law, to which the dispute is closely connected, are considered legitimate under Swiss legal concepts and, upon weighing the interests of the parties involved, the clearly predominant interest(s) of one party so require. Also, the choice of law may not extend to non-contractual obligations. See also “*Enforcement of Judgments—Switzerland*”.

The above principles also apply to security interests.

Under Swiss conflict of law rules, the choice of foreign law with regard to an assignment of claims cannot be invoked against third parties not being the parties to the transaction.

Insolvency law considerations

Green is organized under the laws of Switzerland. In the event of insolvency, insolvency proceedings relating to Green’s guarantee/security interest would likely be subject to Swiss insolvency law. In addition, Swiss debt enforcement and insolvency laws may be applicable in case of an enforcement of security interests over assets of a foreign entity located in Switzerland.

Swiss insolvency law provides for two primary insolvency regimes, the bankruptcy procedure (*Konkurs*) and the composition procedure (*Nachlassverfahren*). Bankruptcy procedure is merely designed to liquidate the debtor’s assets and to distribute the proceeds of the liquidation to the debtor’s creditors. The composition procedure is in general intended to restructure a debtor’s critical financial situation and enable the debtor to continue its business on a reorganized financial basis. It can also be used to liquidate the debtor or the debtor’s assets. Both insolvency regimes and avoidance actions are governed by Swiss law in accordance with the Swiss Federal Act on Debt Enforcement and Bankruptcy as amended from time to time (*Bundesgesetz vom 11. April 1889 über Schuldbetreibung und Konkurs (SchKG), SR 281.1*).

Swiss insolvency laws may make it difficult or impossible to effect a restructuring and the insolvency laws of Switzerland may not be as favorable to your interests as creditors as the laws of the United States or other jurisdictions with which you may be familiar. The following is a brief description of certain aspects of insolvency law in Switzerland. In the event that Green experiences financial difficulty, it is not possible to predict with certainty in which jurisdiction or jurisdictions insolvency or similar proceedings would be commenced, or the outcome of such proceedings.

Pursuant to Swiss insolvency laws, your ability to receive payment under the New Notes may be more limited than would be the case under U.S. or other non-Swiss bankruptcy laws. Under Swiss law, the following types of proceedings (altogether referred to as insolvency proceedings) may be opened against an entity having its registered office or assets in Switzerland.

Bankruptcy Procedure

In the event of a Swiss entity’s insolvency, the respective insolvency proceedings would be governed by Swiss law as a result of such Swiss entity’s office being registered in the competent commercial register in Switzerland. The enforcement of claims and questions relating to insolvency and bankruptcy in general are dealt with by the Swiss Federal Act on Debt Enforcement and Bankruptcy, as amended from time to time. Under these rules, claims that are pursued against a Swiss entity can lead to the opening of bankruptcy (*Konkurs*) and, hence, a general liquidation of all assets, even if located outside Switzerland, and all liabilities of the debtor. However, with regard to assets located outside Switzerland, a Swiss bankruptcy decree may only be enforceable if it is recognized at the place where such assets are located (which requirements are governed by such foreign law). If bankruptcy has not been declared, creditors secured by a pledge must follow a special enforcement proceeding limited to the liquidation of the collateral (*Betreibung auf Pfandverwertung*) unless the parties have agreed on a private sale. The right to collect, purchase, sell or acquire ownership of the assets upon a private sale of the security interest is subject to notification and pricing requirements and must generally be made in accordance with the principles of good faith, adequately taking into account the security provider’s interests.

However, if bankruptcy is declared, while such a special enforcement proceeding is pending, Swiss court proceeding ceases and the creditor participates in the bankruptcy proceedings with the other creditors and a private sale is no longer permitted. Certain particular rules apply to security interests created over intermediated securities pursuant to the Swiss Federal Intermediated Securities Act. As a rule, the opening of bankruptcy by the competent court needs to be preceded by a prior debt enforcement procedure which, involves, inter alia, the issuance of a payment summons by local debt enforcement authorities (*Betreibungsamt*). However, the competent court may also declare a debtor bankrupt without such prior proceedings if the following requirements are met: (i) at the request of the debtor, if the debtor’s board of directors or the auditors of the company (in case of failure of the board of directors) declare that the debtor is over

indebted (überschuldet) within the meaning of article 725 (2) of the Swiss Code of Obligations (*Bundesgesetz betreffend die Ergänzung des Schweizerischen Zivilgesetzbuches (Fünfter Teil: Obligationenrecht, SR 220)*) or if it declares to be insolvent (*zahlungsunfähig*), or (ii) at the request of a creditor, if the debtor commits certain acts to the detriment of its creditors or ceases to make payments (*Zahlungseinstellung*) or if certain events happen during composition proceedings, such as failure to get a moratorium agreement.

The bankruptcy proceedings are carried out and the bankrupt estate is managed by the receiver in bankruptcy (*Konkursverwaltung*) which will draw up an inventory of the assets and, further to a creditor's call for the filing of claims, establish a schedule of claims (*Kollokationsplan*). From a Swiss law perspective, all assets, wherever located at the time of the declaration of bankruptcy and all assets acquired or received subsequently from the bankrupt estate are used to satisfy the creditors, after deduction of costs and certain other expenses. However, in respect of assets located abroad, the Swiss authorities do not have jurisdiction to collect such assets for the purpose of including them in the Swiss bankruptcy estate of the debtor. It is therefore the foreign law applicable at the place where the assets are located abroad, or treaties between Switzerland and the state in which such assets are located, that will determine whether and to what extent the foreign authorities can assist in the collection of these assets. Assets of the bankrupt estate over which a pledge was created in favor of a creditor before the declaration of bankruptcy are included in the bankrupt estate. The pledgee is under an obligation to remit the pledged assets to the bankrupt estate. As a consequence, the private enforcement of pledged assets is not permitted and the enforcement mandatorily occurs according to the rules of the Swiss Federal Act on Debt Enforcement and Bankruptcy and the assets are liquidated by the receiver in bankruptcy in the same manner as the other assets of the bankrupt estate, but the creditor secured by the pledge retains its privilege (after deduction of the estate costs) to be satisfied from the proceeds of the liquidation of the assets pledged to it with priority over the unsecured creditors, unless the proceeds from the sale of the pledged assets exceeds the secured claims, in which case the surplus is available for distribution to the unsecured creditors. If the enforcement proceeds are not sufficient to fully satisfy the secured claims, the remainder of the claims have equal rank as unsecured claims with all other unsecured and (provided that it is not a privileged claim) non prioritized claims. If several pledges secure the same claim, the amount realized is applied proportionally to the claim.

Final distribution of non-secured claims is based on a ranking of creditors in three classes. The first and the second class, which are privileged, comprise claims under employment contracts, accident insurance, pension plans, family law and for deposits under the Swiss banking act. Certain privileges can also be claimed by the government and its subdivisions based on specific provisions of federal law. All other creditors are treated equally (*pari passu*) in the third class. A secured party participates in the third class to the extent its claim is not covered by the proceeds of its collateral.

Any creditor wishing to contest the schedule of claims because its claim has been entirely or partially rejected by the receiver in bankruptcy or not allocated in the rank requested must bring an action against the estate before the competent court. If any creditor wishes to contest the admission of another creditor to the schedule of claims or the allocated rank, it must bring an action against such creditor. Such court proceedings could cause the holders of the New Notes to recover less than the principal amount of their notes or less than they could recover in a United States liquidation. Such proceedings could also cause payment to the holders of the New Notes to be delayed, as compared with holders of undisputed claims.

With the opening of bankruptcy proceedings, interest ceases to accrue against the debtor. However, interest on claims secured by pledges continues to accrue until the realization of the pledge, provided the proceeds exceed the amount of the claim and the interest which had accrued by the date of the opening of bankruptcy proceedings.

Claims or rights assigned for security purposes by a Swiss entity that came into existence prior to the opening of bankruptcy can be enforced by the assignee outside Swiss bankruptcy proceedings. Enforcement in a strict sense is not necessary as the ownership has already been transferred to the secured party. Enforcement in this context essentially means that the obligation to return the transferred assets under the security agreement expires. However, this must follow similar rules as for the private enforcement of a pledge and must generally be made in accordance with the principle of good faith, adequately taking into account the security provider's interests, in particular that the security interests are to be valued fairly, the valuation must be properly documented, the secured obligations must be repaid by set-off out of the realization and any surplus after satisfaction of the secured obligations must be accounted for and repaid to the party having granted the security.

Swiss law is uncertain with respect to the enforceability of future receivables assigned by way of security that come into existence after the date of a bankruptcy. Under the current jurisprudence of the Swiss Federal Supreme Court, the assignment of claims or rights coming into existence after the adjudication of bankruptcy or similar insolvency proceedings that lead to the loss of the capacity of the relevant assignor to dispose of such rights or claims may generally not be enforceable by the secured creditor.

Composition Procedure

Swiss insolvency laws also provide for reorganization procedures by composition with the debtor's creditors. Reorganization is initiated by a request to be made by the debtor itself or in certain circumstances by the creditors with the competent court for a moratorium (*Nachlassstundung*) pending negotiation of the composition agreement with the creditors and confirmation of such agreement by the competent court. If the request meets the statutory prerequisites, i.e. if it does not seem obvious that there is no prospect to reach a composition agreement, the court will grant the debtor a provisional moratorium. Such provisional moratorium may last up to four months. The administrator (*Sachwalter*) appointed by the court must apply for a definitive moratorium of another four to six months which can be extended to twelve months and, in particularly complex cases, to twenty-four months. In the event of an extension exceeding twelve months, administrator shall call for a creditors' meeting.

The composition procedure will result in a settlement with all creditors called a composition agreement. A distinction is made between a composition agreement providing for the assignment of assets (*Nachlassvertrag mit Vermögensabtretung*) (also called the "liquidation agreement") which leads to a liquidation, the creditors being satisfied out of the proceeds of the liquidation, and in many instances has analogous effects as a bankruptcy, and a percentage agreement (*Dividenden-Vergleich*) providing for the payment of a certain percentage on the creditors' claims and the continuation of the debtor, the creditors having waived any excess claims. Further, there is the possibility of a composition in the form of a payment term extension (*Stundungsvergleich*) where the debtor and the creditors agree on a payment plan according to which the debtor will pay its debts in full, but over time. The composition agreement may also provide that the creditors' claims are, fully or partially, satisfied by allocating shares in the debtor company or a company holding the debtors' assets.

During a moratorium, debt collection proceedings cannot be initiated and pending Swiss court proceedings are stayed. Furthermore, the debtor's power to dispose of its assets and to manage its affairs may be restricted. Enforcement proceedings cannot be initiated or continued as long as the moratorium is in effect, except for claims secured by a mortgage on real estate, but such mortgage on real estate may not under any circumstances be realized during the moratorium. If the debtor requests, and if specific requirements are met, the court may also suspend realization of mortgaged real estate for a period up to one year after confirmation of the composition agreement. Private enforcement of pledged chattel is also not admissible during the moratorium. However, after confirmation of a liquidation agreement, enforcement of a lien on chattel is permissible (if not excluded by the liquidation agreement). A secured creditor participates in the settlement only for the amount of its claim not covered by the collateral. The moratorium does not affect the agreed due dates of debts (contrary to bankruptcy, in which case all debts become immediately due upon the opening of bankruptcy proceedings). Unless the composition agreement otherwise stipulates, claims of unsecured creditors no longer bear interest.

The moratorium aims at facilitating the conclusion of one of the above composition agreements. Any composition agreement needs to be approved by the creditors (see below) and confirmed by the competent court. To that end, the court has to appoint an administrator (*Sachwalter*) whose authority may range from supervision of the debtor's activities to actually taking over the management of the debtor. The administrator drafts a composition agreement to be discussed at a creditors' meeting. The composition agreement is deemed ratified if prior to its confirmation by the court, either the majority of creditors, representing two-thirds of all admitted claims, or one-quarter of all creditors, who shall represent at least three-quarters of all admitted claims, have given their consent to the composition agreement. Secured claims are only counted to the extent of the part which, in the administrator's estimation, is not covered by the security. The administrator has to file his report with the court with a recommendation whether or not to confirm the composition agreement. The court will only confirm the agreement if the debtor's offer is reasonable compared to its financial capacities. In case of a percentage agreement or a payment term extension, it is required that the shareholders provide for a reasonable consideration for the company's restructuring. In the case of a liquidation agreement, the reasonability should depend on whether the creditors receive a higher dividend than in a bankruptcy. Furthermore, complete satisfaction of the filed privileged claims and fulfillment of all the obligations incurred with the consent of the administrator during the moratorium must be sufficiently secured, unless individual creditors waive security for their claims. With the judicial confirmation, the composition agreement becomes binding on all creditors (be it any pre-moratorium creditor and any creditor with a claim that has come into existence during the moratorium without approval by the administrator), whereby secured claims are only subject to the composition agreement to the extent that the collateral proves to be insufficient to cover the secured claims.

Avoidance Actions

Certain arrangements or dispositions that are made during certain periods preceding the declaration of bankruptcy or the grant of a moratorium in connection with a composition procedure may be challenged by the receiver in bankruptcy and certain creditors under the applicable rules of avoidance. The avoidance may relate to situations where: (i) an over-indebted company repays unmatured debts, settles a debt by unusual means of payment, or grants collaterals for previously unsecured liabilities within one year before the opening of bankruptcy proceedings; (ii) a debtor disposes of

assets for free or for inadequate consideration, for example, guarantees or security interests for the benefit of third parties if not made on arm's length terms, within one year before the opening of bankruptcy proceedings, or (iii) the debtor carries out a transaction within five years before the opening of bankruptcy proceedings, with the intention, apparent to the other party, of disadvantaging its creditors or of favoring certain of its creditors to the disadvantage of others and in doing so damages the other creditors and in doing so damages the other creditors (whereby the actual test for such intention is an objective one relating to the circumstances at the relevant time and does not require proof of such intention to favor or harm certain creditor). Under certain circumstances these time periods may be suspended.

The granting of guarantees and security interests should not be voidable under (i) above as long as the creditor does not have or should not have any actual or constructive knowledge of the grantor's over-indebtedness. A bona fide creditor is therefore protected but bears the burden to plead and prove its good faith. Furthermore, the granting of guarantees and security interests should in principle not be voidable under (i) above if the guarantee and/or security interest is later granted for previously unsecured liabilities, but the debtor had previously entered into an obligation to provide such guarantee and/or security interest. A guarantee and/or security interest which have been granted for free or inadequate consideration may deem equivalent to a gift pursuant to article 286 of Swiss Federal Act on Debt Enforcement and Bankruptcy.

In the event that such disputed transactions are successfully avoided, the creditors (such as holders of the New Notes) are under the obligation to repay the amounts received. The above principle of avoidance applies in particular to the guarantees or security interests granted by Green. In case of such avoidance of a guarantee or security interest by Green, any amounts obtained by the Noteholders under the guarantee or security interest that is avoided would have to be repaid by the Noteholders. The Noteholders who have restituted the avoided amount paid to them regain the original claim against Green and are entitled to file their claim to be listed in the schedule of claims in their respective rank and priority. The Swiss principles on avoidance may therefore limit the Noteholders' ability to recover payments due on the guarantee or security interest.

Foreign Bankruptcy Decrees

Foreign bankruptcy decrees issued in the country of a debtor's domicile may be recognized in Switzerland only, provided that (i) the bankruptcy decree is enforceable in the country where it was issued, (ii) its recognition is, inter alia, not against Swiss public policy, and (iii) the country which issued the bankruptcy decree grants reciprocity to Switzerland.

Dominican Republic

Conditions to be satisfied for the granting of guarantees/security interests in the Dominican Republic are derived from general principles of law and must be applied to each specific case. Generally these conditions relate to (i) capacity and (ii) corporate authority.

Capacity

A company incorporated in the Dominican Republic (a "Dominican Company") has the capacity to enter into agreements necessary or convenient according to the corporate purpose established under its bylaws, including financing and security agreements.

The goal to create value and therefore profits for its shareholders is an essential element of every company and therefore, an act without receiving consideration may fall outside the scope of the purpose of a Dominican Company and could be challenged for lack of interest/cause. However, a Dominican Company may grant security/guarantee in favor of a parent/controlling entity or in favor of subsidiaries or other related entities belonging to the same corporate group.

The granting of a guarantee/security by a Dominican Company must be for its corporate benefit (*interés social*). There is no statutory definition of corporate benefit under Dominican law; understanding that the existence or absence of corporate benefit is assessed by the courts on a case by case basis.

A guarantee/security interest could be held unenforceable if it is contrary to public policy.

Corporate Authority

When a Dominican Company grants guarantees/security interests, applicable corporate procedures normally entail that the decision be approved by a board resolution or by decision of shareholders in a general shareholders meeting, in each case according to applicable rules of quorum and majority set forth by the bylaws/law.

According to Article 217 of General Corporations Law No. 479-08 (as amended), issuance of corporate guarantee by a Dominican Company shall be approved by the Board of Directors, unless the bylaws require approval by the general shareholders meeting. On the other hand, pursuant to Article 327 of the said law a Dominican Company shall not grant as security obligations issued by such company.

Under General Corporations Law No. 479-08 (amended) the following transactions require authorization by the Board of Directors: (i) transactions with one or more of the members of the Board of Managers of a Dominican Company; (ii) transactions with third parties where one or more of the members of the Board of Managers of a Dominican Company have an interest in any manner; (iii) transactions with other entities where one or more of the members of the Board of Managers owns shares or is also member of the board of managers of such other entity. In addition, under General Corporations Law No. 479-08 (as amended), approval by the shareholders meeting shall be required in addition to board approval when any of the previously mentioned transactions involve an amount equal to or greater than 15% of the equity of a Dominican Company, individually or in the aggregate (on a 12 months basis).

Grace period

Under Article 1244 of the Dominican Civil Code, a Dominican court may under certain conditions grant a grace period in favor of debtor. When a debt is secured by a mortgage over real estate assets, grace period shall not exceed six months. During the grace period collection actions are suspended including any pending enforcement measures that may have been initiated by creditors. A debtor cannot waive in advance its right to ask the court for a grace period.

Security interests considerations

Governing law

The courts in Dominican Republic will generally apply the law of the place where the assets or subject matter of the pledge or security interest is located in relation to the creation, perfection and enforcement of security interests over such asset. As a consequence, Dominican law will apply in relation to the creation, perfection and enforcement of security interests over assets located in the Dominican Republic.

Perfection/Lien

Under Dominican law, the perfection of security interests and creation of liens depend on certain registration, notification and/or acceptance requirements applicable according to the type of security being perfected. For example: In a pledge of nominative shares (i) the pledge must be notified to the company that issued the shares by means of a bailiff notice for the pledge to become opposable to third parties and issuer, (ii) possession of the share certificates shall be delivered to creditor or to a third party agreed upon by both creditor and pledger; (iii) share certificates should be endorsed, (iv) pledge should be registered in the shareholders' register of the issuing company and at the Mercantile Registry of the corresponding Chamber of Commerce for the pledge to be opposable to third parties, and (v) the pledge shall have been authorized by the Board of Directors of the company or by the General Shareholders Meeting. A receivables pledge becomes enforceable against third parties after it has been notified to payer by means of a bailiff notice or acknowledged by payer in a notarial act (acto auténtico). A pledge over a bank account becomes effective against the bank and third parties once it has been notified to the bank by means of a bailiff notice or acknowledged by the latter in a notarial act. Mortgages over real estate must be registered with the corresponding Title Registry Office. Chattel Pledge shall become enforceable against third parties after registration at the corresponding Justice of Peace Office. A pledge over motor vehicles shall become enforceable against third parties after registration at the corresponding Department of the Dominican Tax Authorities (DGII by its Spanish acronym).

Enforcement methods

In general, foreclosure requires judicial foreclosure procedures to be carried out before Dominican Courts. Procedures vary depending on the type of asset/security being foreclosed on. There are certain requirements providing for notification to debtor, publicity and court hearings. Procedures normally end with a sale of the underlying asset at a public auction. However, in some cases (such as foreclosure on a pledge) creditor can either ask the court to sell the pledged assets at a public auction or request the court that the said assets be transferred to the creditor in payment of the secured debt. Contractual provisions allowing a creditor obtain ownership of the underlying asset without following judicial foreclosure procedures are generally considered null.

Rights of third parties

The existence of security interests created pursuant to pledge/security agreements does not prevent third party creditors from seeking attachment or execution of assets already subject to a security interest created in favor of another creditor.

A third party creditor may seek the forced sale of the said assets through court proceedings, although the secured creditor can oppose and should be entitled to priority over the proceeds of the sale.

Language

Documents creating security may be executed in English or another language. However, for registration and enforcement purposes or any other official use, a translation into Spanish prepared by an Official Translator duly authorized in the Dominican Republic is required.

Insolvency—Statutory Priorities

The ability of creditors to enforce security and collect under guarantees or security interests granted by a Dominican Company may be delayed, terminated or otherwise adversely affected by (i) insolvency/bankruptcy proceedings under Dominican law, or (ii) statutory priorities adversely affecting rights of secured creditors generally.

Insolvency—Bankruptcy

In the Dominican Republic, insolvency proceedings of commercial entities are governed by the Commercial Code of the Dominican Republic. This Code dates back to 1884 and resembles the French Commercial Code of 1807. Insolvency procedure contained therein is rarely used in practice except in some particular cases most of which never reached a conclusion.

In the event of insolvency of debtor, the Commercial Code provides the right to any interested party to bring an action under the Commercial Courts to open insolvency proceedings against the debtor.

In general secured creditors have priority rights (except for statutory priorities) to collect on their collateral and therefore are not affected by bankruptcy/insolvency proceedings unless they renounce/waive their security. Secured creditors have the right to participate in the distribution of other assets of debtor if their collateral is insufficient to cover their claims.

Once the insolvency procedure is opened:

- (a) The actions made by individual creditors against the Bankrupt are frozen. The seizure of assets by creditors through attachment or execution are stayed and replaced by a right to claim for a dividend against the pool;
- (b) all assets of the Bankrupt belong to the pool of assets which is available to pay creditor claims; and
- (c) creditors are paid *pari passu* out of the assets according to the hierarchy or ladder of priorities of their claims.

The insolvency procedure established in the Commercial Code resembles a final liquidation/winding up procedure or prepacking. The state of insolvency of a ‘merchant’ is determined when the latter ‘ceases in the payment’ of its obligations. The term ‘ceases in the payment’ (“cesación de pagos”) is different from insolvency in that the former applies if the Debtor does not comply with its due, liquid and enforceable debts then it has formally ceased in the payment of its liabilities. It does not relate to its debt-equity ratio whereby the assets could not cover the debts. Therefore, the debtor may become insolvent in the financial side but does not fall under the ‘cease of payments’ if it continues to pay off its debts.

The procedure starts off at the request of the claimant in the conciliation procedure of the Ministry of Industry and Commerce via the Chamber of Commerce and Production. The Chamber summons the debtor and grants the latter a period of 10 days to deposit its accounting records and balance sheet. The chamber fixes the date and time for the parties to meet to verify the credits and to reach a possible settlement. If no settlement is reached, the claimant may sue for a judicial order to declare bankruptcy of the Debtor. The judicial order to be issued will appoint a provisional liquidator, a judicial manager and will order the Justice of Peace to seal all of debtors’ assets. The bankruptcy judicial order shall be published in a national newspaper and it is subject to special formalities.

The issuance of the bankruptcy judicial order will have the following effects:

- (a) All outstanding debts will be accelerated and immediately enforceable;
- (b) stays on creditor’s executions, transfers of personal or real property without consideration; all payments in kind, for sale, stock, setoff or any other manner for any owed unmatured debts; all outstanding debts that does not involve payments in cash; all conventional or judicial mortgages; chattel pledge recorded on the debtor for past debts; and

(c) the removal of the merchant's board of directors or managers from the management of the merchant assets.

The Court shall indicate in the bankruptcy order the date on which debtor's state of insolvency started. If the Court fails to determine said date, the date of issuance of the bankruptcy order shall be deemed as the date on which the debtor entered into a state of insolvency. According to Dominican Law, the Court shall also appoint a Judge to oversee bankruptcy proceedings and shall order that debtor's assets be inventoried.

Payments made after the insolvency date or within 10 days prior to such insolvency date can be void or annulled if made: 1) other than in cash; 2) for compensation; or 3) for the payment of obligations not yet due. Payments made to a creditor that knew in advance that debtor had fallen into a cessation of payments state ("estado de cesación de pagos") can also be declared void or annulled. All collateral consented by debtor within this period of time can also be annulled.

Once the definitive liquidator is appointed within 3 days there will be a release of the seals recorded on the debtor's assets and an inventory will be made in the presence of the Justice of Peace. A consolidation of the assets is made which will culminate with a final judicial order approving or denying the liquidation.

With this judicial order the creditors must file in the court their title and security interests. The Secretary of the Court will order all remaining creditors to file in a term of 20 days all their title and security interests to the liquidator. In a term of 3 days after the furnishing of all credits a verification procedure of all credits and confirmation will be initiated by the judicial manager. A period of 8 days will elapse so that the creditors may ratify the credits to the judicial manager. In a period of 3 days after the confirmation of all credits, the judicial manager will summon all provisional admitted creditors to discuss the formation of a reorganization plan for the liquidation of the assets. Minutes of a meeting will be held to agree on the reorganization plan, the creditors will be allowed to vote and decisions will be taken on a majority vote. If the majority votes are reached, then the reorganization plan will be approved. If the votes do not reach the required majority, then the execution of the reorganization plan will be adjourned and a new date will be fixed for another minutes of a meeting.

In the event that no agreement is reached, the pool of creditors will be considered to be in union. There will be an additional period of 8 days for the filing of any opposition to the liquidator. Upon the expiration of this term, any party may request the validation of the reorganization plan. If no agreement on the reorganization plan is reached, a realization of the debtor's assets will be made by the liquidator and the proceeds for that sale will be distributed pro rata between the creditors.

In practice, however, the bankruptcy process as detailed herein is rarely opened and followed until it reaches its conclusion.

Statutory priorities

Certain types of credits are granted priority in collection by Dominican Law and are therefore considered privileged credits (créditos privilegiados). Privileged credits shall have preference in collecting from debtors assets even in the presence of secured creditors possessing liens on debtor's assets. Creditors with statutory priority include, among others; (i) employees (for collection of salaries, wages and labor compensation), (ii) Dominican tax authorities (for collection of tax obligations), (iii) lawyers (for collection of legal fees), and (iv) landlords (for collection of rent).

PLAN OF DISTRIBUTION

The Issuers have agreed to sell to the Initial Purchasers, and the Initial Purchasers have agreed to purchase from the Issuers, the entire aggregate principal amount of the New Notes. The sale was made pursuant to a purchase agreement dated January 30, 2015.

The obligations of the Initial Purchasers under the purchase agreement, including their agreement to purchase New Senior Secured Notes from the Senior Secured Notes Issuer and New Senior Notes from the Senior Notes Issuer, are several and not joint. Pursuant to the terms of the purchase agreement, the Senior Secured Notes Issuer has agreed to sell to each Initial Purchaser, and each Initial Purchaser has agreed, severally and not jointly, to purchase from the Senior Secured Notes Issuer, together with all other Initial Purchasers, Dollar Senior Secured Notes in an aggregate principal amount of \$2,060 million and Euro Senior Secured Notes in an aggregate principal amount of €500 million, and the Senior Notes Issuer has agreed to sell to each Initial Purchaser, and each Initial Purchaser has agreed, severally and not jointly, to purchase from the Senior Notes Issuer, together with all other Initial Purchasers, New Senior Notes in an aggregate principal amount of \$385 million.

The Initial Purchasers initially propose to offer the New Notes for resale at the issue price that appears on the cover of these Listing Particulars. After the initial offering, the Initial Purchasers may change the offering price and any other selling terms. The Initial Purchasers may offer and sell New Notes through certain of their affiliates. Sales in the United States will be made through affiliates of the Initial Purchasers which are registered with the SEC as U.S. registered broker dealers.

In the purchase agreement, the Issuers have agreed and, at the time of accession to the purchase agreement, the Guarantors will agree that:

- each of the Issuers, Altice International and, at the time of accession to the purchase agreement, the Guarantors will not offer, sell, contract to sell or otherwise dispose of, any debt securities (other than the New Notes, the Guarantees, intercopy debt and any debt securities of Senior Secured Issuer not to exceed €125 million equivalent), without the prior written consent of the Representatives (as defined therein), for a period of 45 days after the date of the final Offering Memorandum.
- the Issuers will indemnify the Initial Purchasers and their respective affiliates against certain liabilities, including liabilities under the U.S. Securities Act, or contribute to payments that the Initial Purchasers may be required to make in respect of those liabilities.

United States

Each purchaser of New Notes offered by these Listing Particulars, in making its purchase, will be deemed to have made the acknowledgements, representations and agreements as described under “*Transfer Restrictions*”.

The New Notes have not been and will not be registered under the U.S. Securities Act and may not be offered or sold within the United States or to, or for the account or benefit of, U.S. persons except to qualified institutional buyers in reliance on Rule 144A under the U.S. Securities Act and to persons in offshore transactions in reliance on Regulation S under the U.S. Securities Act. Until 40 days after the later of (i) the commencement of this offering and (ii) the issue date of the New Notes, an offer or sale within the United States of New Notes initially sold in reliance on Regulation S by a dealer (whether or not participating in the offering) may violate the registration requirements for the U.S. Securities Act if such offer or sale is made otherwise than in accordance with Rule 144A under the U.S. Securities Act. For a description of certain further restrictions on resale or transfer of the New Notes, see “*Transfer Restrictions*”.

The New Notes may not be offered to the public within any jurisdiction. By accepting delivery of these Listing Particulars, you agree not to offer, sell, resell, transfer or deliver, directly or indirectly, any New Note to the public.

United Kingdom

In the purchase agreement, each Initial Purchaser has also represented and agreed that:

- (i) it has complied and will comply with all applicable provisions of the FSM Act with respect to anything done by it in relation to the New Notes in, from or otherwise involving the United Kingdom; and
- (ii) it has only communicated or caused to be communicated and it will only communicate or cause to be communicated any invitation or inducement to engage in investment activity (within the meaning of section 21

of the FSM Act) received by it in connection with the issue or sale of any New Notes in circumstances in which section 21(1) of the FSM Act does not apply to such Initial Purchaser.

These Listing Particulars are directed solely at persons who (i) are outside the United Kingdom or (ii) have professional experience in matters relating to investments or (iii) are persons falling within Article 49(2)(a) to (d) of The Financial Services and Markets Act 2000 (Financial Promotion) Order 2005 (all such persons together being referred to as “relevant persons”). These Listing Particulars must not be acted on or relied on by persons who are not relevant persons. Any investment or investment activity to which these Listing Particulars relates is available only to relevant persons and will be engaged in only with relevant persons.

Grand Duchy of Luxembourg

In addition to the cases described in the section entitled “Public Offer Selling Restriction under the EU Prospectus Directive” in which the Initial Purchasers can make an offer of the New Notes to the public in an EEA Member State (including Luxembourg), the Initial Purchasers can also make an offer of the New Notes to the public in Luxembourg:

- (a) at any time, to national and regional governments, central banks, international and supranational institutions (such as the International Monetary Fund, the European Central Bank, the European Investment Bank) and other similar international organizations;
- (b) at any time, to legal entities which are authorized or regulated to operate in the financial markets (including credit institutions, investment firms, other authorized or regulated financial institutions, undertakings for collective investment and their management companies, pension and investment funds and their management companies, insurance undertakings and commodity dealers) as well as entities not so authorized or regulated whose corporate purpose is solely to invest in securities; and
- (c) at any time, to certain natural persons or small and medium-sized enterprises (as defined in the Prospectus Act implementing the EU Prospectus Directive into Luxembourg law) recorded in the register of natural persons or small and medium-sized enterprises considered as qualified investors as held by the Commission de surveillance du secteur financier as competent authority in Luxembourg in accordance with the EU Prospectus Directive.

Israel

Sales of the New Notes in Israel will be made through the Initial Purchasers and/or through an Israeli broker(s) engaged by them. The New Notes will not be offered to an Israeli person unless such offeree is a “qualified investor” (as defined in the First Appendix to the Israeli Securities Law) who is not an individual (a “Qualified Israeli Investor”) and who (x) completed and signed a questionnaire regarding its qualifications as a Qualified Israel Investor and (y) certified that it has an exemption from Israeli withholding taxes on interest and delivered a copy of such certification to Goldman Sachs International.

General

The New Notes are a new issue of securities, and there is currently no established trading market for the New Notes. In addition, the New Notes are subject to certain restrictions on resale and transfer as described under “Transfer Restrictions”. The Senior Notes Issuer will apply for the New Senior Notes and the Senior Secured Notes Issuer will apply for the New Senior Secured Notes to be admitted to listing and to trading on the Euro MTF Market of the Luxembourg Stock Exchange. The Initial Purchasers have advised us that they intend to make a market in the New Notes, but they are not obligated to do so. The Initial Purchasers may discontinue any market making in the New Notes at any time in their sole discretion. In addition, such market making activities will be subject to the limits imposed by the U.S. Securities Act and the U.S. Exchange Act. Accordingly, we cannot assure you that a liquid trading market will develop for the New Notes, that you will be able to sell your New Senior Notes at a particular time or that the prices that you receive when you sell will be favorable.

You should be aware that the laws and practices of certain countries require investors to pay stamp taxes and other charges in connection with purchases of securities.

Each Initial Purchaser has also agreed in the purchase agreement that it will (to the best of its knowledge and belief) comply with all applicable securities laws and regulations in force in any jurisdiction in which it purchases, offers, sells or delivers New Notes or possesses or distributes these Listing Particulars, and will obtain any consent, approval or permission required by it for the purchase, offer, sale or delivery by it of New Notes under the laws and regulations in force.

In connection with the offering of the New Notes, the Initial Purchasers may engage in overallotment, stabilizing transactions and syndicate covering transactions. Overallotment involves sales in excess of the offering size, which creates a short position for the Initial Purchasers. Stabilizing transactions involve bids to purchase the New Notes in the open market for the purpose of pegging, fixing or maintaining the price of the New Notes. Syndicate covering transactions involve purchases of the New Notes in the open market after the distribution has been completed in order to cover short positions. Stabilizing transactions and syndicate covering transactions may cause the price of the New Notes to be higher than it would otherwise be in the absence of those transactions. If the Initial Purchasers engage in stabilizing or syndicate covering transactions, they may discontinue them at any time.

Delivery of the New Notes was made against payment on the New Senior Notes on or about the Issue Date, which was three business days following the date of pricing of the New Notes.

Other Relationships

The Initial Purchasers or their respective affiliates from time to time have provided in the past and may enter into in the future investment banking, financial advisory and/or lending and commercial banking transactions with, and may perform services for us and our affiliates in the ordinary course of business for which they have received or may receive customary fees and commissions (including acting as initial purchasers in connection with previous issuances of debt securities of Altice International or its subsidiaries). In connection with our strategy to review and evaluate selective acquisitions and other business combinations, we and our shareholders regularly engage mergers and acquisition advisors and other financial advisors to assist us. Certain of the Initial Purchasers and their affiliates may be currently advising us or other interested parties, and the Initial Purchasers and their affiliates may advise us or other interested parties from time to time on other transactions in the future. Deutsche Bank AG, London Branch or one of its affiliates is currently acting as financial advisor to PT Portugal in connection with the PT Portugal Acquisition.

BNP Paribas, Crédit Agricole Corporate and Investment Bank, Credit Suisse Securities (Europe) Limited, Goldman Sachs International, HSBC Bank plc, J.P. Morgan Securities plc and Morgan Stanley & Co. International plc or one of their affiliates are or were mandated lead arrangers and lenders, Citibank International Limited (previously Citibank International plc) is facility agent and Citibank, N.A., London Branch is security agent under the 2012 Revolving Credit Facility.

Goldman Sachs International, Morgan Stanley & Co. International plc, Crédit Agricole Corporate and Investment Bank, Credit Suisse Securities (Europe) Limited, Deutsche Bank AG, London Branch or one of their affiliates are or were mandated lead arrangers and lenders, Citibank International Limited (previously Citibank International plc) is facility agent and Citibank, N.A., London Branch is security agent under the 2013 Revolving Credit Facility.

Goldman Sachs International, Morgan Stanley & Co. International plc, Crédit Agricole Corporate and Investment Bank, Credit Suisse Securities (Europe) Limited, Deutsche Bank AG, London Branch or one of their affiliates are or were mandated lead arrangers and lenders and Citibank, N.A., London Branch is security agent under the 2013 Guarantee Facility.

Goldman Sachs International, Morgan Stanley & Co. International plc, Credit Suisse Securities (Europe) Limited, Deutsche Bank AG, London Branch, Crédit Agricole Corporate and Investment Bank or one of their affiliates are or were joint lead bookrunners, joint lead arrangers and lenders, Goldman Sachs Lending Partners LLC is administrative agent and Citibank, N.A., London Branch is security agent under the 2013 Term Loan.

Morgan Stanley & Co. International plc, Deutsche Bank AG, London Branch, Goldman Sachs International, J.P. Morgan Securities plc, Credit Suisse Securities (Europe) Limited, BNP Paribas, Crédit Agricole Corporate and Investment Bank, or one of their affiliates are or were mandated lead arrangers and lenders, Citibank International Limited is facility agent and Citibank, N.A., London Branch is security agent under the New Pari Passu Revolving Credit Facility.

Each of the Initial Purchasers or one of its affiliates (other than Banca IMI S.p.A., RBC Europe Limited and UniCredit Bank AG) will be a joint lead bookrunner, joint lead arranger and lender, Deutsche Bank AG, London Branch and Deutsche Bank AG, New York Branch will be administrative agents and Citibank, N.A., London Branch will be security agent under the New Term Loan.

UniCredit Bank AG and RBC Europe Limited and their affiliates are not lenders under any of the agreements described above. Banca IMI S.p.A. or its affiliates and/or parent companies has provided significant financing to the Issuers and its parents and group companies.

Each of the Initial Purchasers or one of its affiliates will be a mandated lead arranger and lender, Citibank International Limited will be facility agent and Citibank, N.A., London Branch will be security agent under the New Super Senior Revolving Credit Facility.

In addition, certain of the Initial Purchasers or their affiliates are party to certain of our hedging arrangements and other financing and/or debt arrangements and may hold other proprietary positions (including long or short positions) in us, our current or future subsidiaries and affiliates and/or financial intermediaries and the financial instruments issued by any of them. Certain of the Initial Purchasers or their affiliates that have a lending relationship with Altice International and/or its affiliates have hedged, and are likely to hedge in the future, their credit exposure to Altice International and/or its affiliates consistent with their risk management policies. Typically, these Initial Purchasers and their affiliates would hedge such exposure by entering into transactions which consist of either the purchase of credit default swaps or the creation of short positions in our securities, including potentially the New Notes offered hereby. Any such credit default swaps or short positions could adversely affect future trading prices of the New Notes offered hereby.

A former executive at Morgan Stanley, one of the Initial Purchasers, became one of Altice S.A.'s non executive directors on January 16, 2014.

LEGAL MATTERS

Certain legal matters in connection with this offering will be passed upon for us by Ropes & Gray International, as to matters of United States federal, New York and English law; by Meitar Liquornik Geva Leshem Tal, as to matters of Israeli law; by Luther, as to matters of Luxembourg law, by Uria Menéndez—Proença de Carvalho, as to matters of Portuguese law; by Baker & McKenzie as to matters of Belgian law; by Franklin and Nabarro & Hinge as to matters of French law; by Holenstein attorneys-at-law Ltd, as to matters of Swiss law and by Castillo y Castillo as to matters of Dominican law.

Certain legal matters in connection with this offering will be passed upon for the Initial Purchasers by Latham & Watkins (London) LLP, as to matters of United States federal, New York and English law; by Goldfarb Seligman & Co., as to matters of Israeli law; by Elvinger, Hoss & Prussen, as to matters of Luxembourg law; by Cuatrecasas, Gonçalves Pereira, RL, as to matters of Portuguese law; by Latham & Watkins AAPRI as to matters of French law; as to matters of Swiss law by Pestalozzi Attorneys at Law Ltd and by Pellerano & Herrera as to matters of Dominican law.

Certain legal matters in connection with this offering will be passed upon for the Trustee by White & Case LLP, as to matters of New York law.

ENFORCEMENT OF JUDGMENTS

The Issuers are a public limited liability company (*société anonyme*), incorporated under the laws of the Grand Duchy of Luxembourg and the Guarantors are incorporated under the laws of France, Israel, Luxembourg, Switzerland, Portugal and the Dominican Republic.

Many of the directors, members of the supervisory board, general partners, officers and other executives of the Issuers and the Guarantors are neither residents nor citizens of the United States. Furthermore, most of our assets are located outside the United States. As a result, it may not be possible for investors to effect service of process within the United States upon such persons, the Issuers or the Guarantors, or to enforce against them judgments of U.S. courts predicated upon the civil liability provisions of U.S. federal or state securities laws despite the fact that, pursuant to the terms of each of the New Indentures, the Issuers and the Guarantors have appointed, or will appoint, an agent for the service of process in New York. It may be possible for investors to effect service of process within France, Israel, Luxembourg, Switzerland, Portugal and the Dominican Republic upon those persons, the Issuers or the Guarantors provided that the Hague Convention on the Service Abroad of Judicial and Commercial Matters of November 15, 1965 is complied with.

Israel

The Issuers have been advised by their Israeli counsel that, subject to specified time limitations and legal procedures, Israeli courts may enforce a foreign judgment in a civil matter which is non-appealable, provided that among other things:

- the judgment is obtained after due process before a court of competent jurisdiction, according to the laws of the foreign state in which the judgment is given and the rules of private international law currently prevailing in Israel;
- the prevailing law of the foreign state in which the judgment is rendered allows for the enforcement of judgments of Israeli courts;
- adequate service of process has been effected and the defendant has had a reasonable opportunity to be heard and to present his or her evidence;
- the judgment is not contrary to public policy of Israel, and the enforcement of the civil liabilities set forth in the judgment is not likely to impair the security or sovereignty of Israel;
- the judgment was not obtained by fraud and does not conflict with any other valid judgment in the same matter between the same parties;
- an action between the same parties in the same matter was not pending in any Israeli court at the time at which the lawsuit was instituted in the foreign court; and
- the judgment is enforceable according to the laws of Israel and according to the law of the foreign state in which the relief was granted.

If a foreign judgment is enforced by an Israeli court, it generally will be payable in Israeli currency, which can then be converted into non-Israeli currency and transferred out of Israel. The usual practice in an action before an Israeli court to recover an amount in a non-Israeli currency is for the Israeli court to issue a judgment for the equivalent amount in Israeli currency at the rate of exchange in force on the date of the judgment, but the judgment debtor may make payment in foreign currency. Pending collection, the amount of the judgment of an Israeli court stated in Israeli currency ordinarily will be linked to the Israeli consumer price index plus a per annum statutory rate of interest set on a quarterly basis by Israeli regulations. Judgment creditors must bear the risk of unfavorable exchange rates. In recent years, Israeli courts have increasingly been willing to enforce a foreign judgment in the foreign currency specified in the judgment, in which case there are also applicable rules regarding the payment of interest.

Luxembourg

The Issuers have been advised by Luther, their Luxembourg counsel, that a valid final and conclusive judgment against an issuer of Luxembourg nationality with respect to the New Notes obtained from a court of competent jurisdiction in the United States, which judgment remains in full force and effect after all appeals as may be taken in the relevant state or federal jurisdiction with respect thereto have been taken, may be entered and enforced through a court of competent jurisdiction of Luxembourg subject to compliance with the enforcement procedures set out in Article 678 et seq. of the Luxembourg *Nouveau Code de Procedure Civile* being:

- the U.S. court awarding the judgment has jurisdiction to adjudicate the respective matter under its applicable laws, and such jurisdiction is recognized by Luxembourg private international and local law;
- the judgment is final and enforceable in the jurisdiction where the decision is rendered;
- the U.S. Court has applied the substantive law as designated by the Luxembourg conflict of laws rules;
- the U.S. Court has acted in accordance with its own procedural laws;
- the judgment was granted following proceedings where the counterparty had the opportunity to appear, and if appeared, to present a defense;
- the decision of the U.S. Court must not have been obtained by fraud; and
- the decisions and the considerations of the foreign court must not be contrary to Luxembourg international public policy rules or have been given in proceedings of a tax, penal or criminal nature (which would include awards of damages made under civil liabilities provisions of the U.S. federal securities laws, or other laws, to the extent that the same would be classified by Luxembourg courts as being of a penal or punitive nature (for example, fines or punitive damages)) or rendered subsequent to an evasion of Luxembourg law (*fraude à la loi*).

The Issuers have also been also advised by their Luxembourg counsel that if an original action is brought in Luxembourg, without prejudice to specific conflict of law rules, Luxembourg courts may refuse to apply the designated law if the choice of such foreign law was not made *bona fide* or if (i) the foreign law was not pleaded and proved or (ii) if pleaded and proved, such foreign law was contrary to mandatory Luxembourg laws or incompatible with Luxembourg public policy rules. In an action brought in Luxembourg on the basis of U.S. federal or state securities laws, Luxembourg courts may not have the requisite power to grant the remedies sought.

Portugal

The Issuers have been advised by their Portuguese counsel, that a valid, final and conclusive judgment against a guarantor of Portuguese nationality with respect to its Guarantee obtained from a court of competent jurisdiction in the United States, which judgment remains in full force and effect after all appeals as may be taken in the relevant state or federal jurisdiction with respect thereto have been taken, may be entered and enforced through a court of competent jurisdiction of Portugal subject to compliance with the judgments enforcement requirements including, without limitation, those set out in Article 980 et seq. of the Portuguese Civil Procedure Code (*Código do Processo Civil*) being:

- there are no doubts regarding the authenticity of the judgment or the reasoning of the judgment;
- the judgment is final and enforceable in the jurisdiction where the decision is rendered;
- the judgment of the U.S. Court has not been obtained by fraud and does not relate to a matter on which Portuguese courts have exclusive jurisdiction;
- the judgment of the U.S. Court does not refer to a matter that has been decided by a Portuguese court or that is being subject to a proceeding before a Portuguese Court, except if the judgment of the U.S. Court prevents this jurisdiction;
- the defendant was duly notified by the U.S. Court in accordance with its own procedural laws and that the defendant had the opportunity to present a defense (*princípio do contraditório*) with equal defense rights (*princípio da igualdade das partes*);
- the enforcement of the judgment will not lead to a breach which is manifestly contrary to Portuguese international public policy rules; and
- the request of recognition of a judgment rendered by a court of competent jurisdiction in the United States may be challenged if the party against whom the judgment was rendered is a Portuguese citizen or a Portuguese company and the result of the judgment would be more favorable to said party if the United State's court had applied Portuguese law (assuming that the Portuguese law would be applicable according to the Portuguese rules of conflict of laws).

France

As described in “*Corporate and Financing Structure*”, certain guarantees and securities have been granted by companies incorporated in France, and security has been granted over assets located in France.

The United States and France are not party to a treaty providing for reciprocal recognition and enforcement of judgments, other than arbitral awards, rendered in civil and commercial matters. Accordingly, a judgment rendered by any U.S. Federal or state court based on civil liability, whether or not predicated solely upon U.S. Federal or state securities laws, enforceable in the United States, would not directly be recognized or enforceable in France. A party in whose favor such judgment was rendered could initiate enforcement proceedings (*exequatur*) in France before the relevant civil court (*Tribunal de Grande Instance*). Enforcement in France of such U.S. judgment could be obtained following proper (i.e., non-ex parte) proceedings if the civil court is satisfied that the following conditions have been met (which conditions, under prevailing French case law, do not include a review by the French court of the merits of the foreign judgment):

- such U.S. judgment was rendered by a court having jurisdiction over the matters as the dispute is sufficiently connected with the jurisdiction of the court which rendered it, the choice of the U.S. court was not fraudulent and the French courts did not have exclusive jurisdiction over the matter;
- such U.S. judgment does not contravene French international public policy rules, both pertaining to the merits and to the procedure of the case;
- such U.S. judgment is not tainted with fraud; and
- such U.S. judgment does not conflict with a French judgment or a foreign judgment which has become effective in France and there are no proceedings pending before French courts at the time enforcement of the judgment is sought and having the same or similar subject matter as such U.S. judgment.

In addition, the discovery process under actions filed in the United States could be adversely affected under certain circumstances by French law No. 68-678 of July 26, 1968, as modified by French laws No. 80- 538 of July 16, 1980 and by Order No. 200-916 of September 19, 2000 (relating to communication of documents and information of an economic, commercial, industrial, financial or technical nature to foreign authorities or persons), which could prohibit or restrict obtaining evidence in France or from French persons in connection with a judicial or administrative U.S. action.

Similarly, French data protection rules (French law No. 78-17 of January 6, 1978 on data processing, data files and individual liberties, as last modified by French law No. 2014-344 of March 17, 2014) can limit under certain circumstances the possibility of obtaining information in France or from French persons in connection with a judicial or administrative U.S. action in a discovery context.

If an original action is brought in France, French courts may refuse to apply the designated law if its application contravenes French public policy. In an action brought in France on the basis of U.S. Federal or state securities laws, French courts may not have the requisite power to grant all the remedies sought.

Pursuant to articles 14 and 15 of the French Civil Code, a French national (either a company or an individual) can sue a foreign defendant before French courts in connection with the performance of obligations contracted by the foreign defendant in France with a French person or in a foreign country towards French persons (article 14) and can be sued by a foreign claimant before French courts in connection with the performance of obligations contracted by the French national in a foreign country towards the foreign claimant (article 15). For a long time, case law has interpreted these provisions as meaning that a French national, either claimant or defendant, could not be forced against its will to appear before a jurisdiction other than French courts. However, according to recent case law, the French courts jurisdiction towards French nationals is no longer mandatory to the extent an action has been commenced or brought before a court in a jurisdiction which has sufficient contacts with the litigation and the choice of jurisdiction is not fraudulent. In addition, the French national may waive its rights to benefit from the provisions of articles 14 and 15 of the French Civil Code.

The French Supreme Court (*Cour de Cassation*) has recently held that a contractual provision submitting one party to the exclusive jurisdiction of a court and giving another party the discretionary option to choose any competent jurisdiction was invalid on the ground that it was discretionary (potestative). Accordingly, any provisions to the same effect in any relevant documents would not be binding over the party submitted court.

Switzerland

Judgments in civil or commercial matters of a non-Swiss court or authority will be recognized and enforced against an individual or a legal entity with legal domicile or seat in Switzerland pursuant to a bilateral or multilateral treaty or

convention between the foreign country and Switzerland e.g. the Lugano Convention on Jurisdiction and Enforcement of Judgments of October 30, 2007. In case no applicable treaty or convention exists, the rules of the Swiss Federal Act on Private International Law (*Bundesgesetz über das Internationale Privatrecht vom 18. Dezember 1987 (IPRG)*;"PILA"; SR 291) apply. Except for arbitral awards, there is currently no treaty or convention in effect pertaining to the recognition and enforcement of judgments in civil and commercial matters between the United States of America and Switzerland.

Thus, articles 25-32 PILA apply for the recognition and enforcement of an U.S. federal or state court judgment ("U.S. Judgment") in Switzerland. In cases where an U.S. money judgment shall be enforced, the Swiss Federal Act on Debt Enforcement and Bankruptcy (SR 281.1) and the Swiss Code of Civil Procedure (*Schweizerische Zivilprozessordnung vom 19. Dezember 2008 (ZPO)*, SR 272), apply in addition to the PILA. The judgment of a Swiss court or authority of first instance concerning recognition and enforcement of a foreign judgment, including a U.S. Judgment, is generally subject to appeal (on the cantonal level as well as on the federal level).

There is doubt as to the enforceability in Switzerland of civil liabilities based on the security laws of the United States, either in an original action or in an action to enforce a judgment obtained in the U.S. courts. The United States and Switzerland currently do not have a treaty providing for the reciprocal recognition and enforcement of judgments, other than arbitration awards, in civil and commercial matters. Consequently, a final judgment for payment issued by a court in the United States, whether or not predicated solely upon U.S. security laws, may not be enforceable in Switzerland.

However, if a person has obtained a final and conclusive judgment rendered by a U.S. court which is enforceable in the United States and files a claim with the competent Swiss court, the Swiss court may be expected to acknowledge the judgment rendered by the U.S. court, provided that (i) there are no grounds to refuse recognition and enforcement and (ii) such judgment has not been rendered in violation of elementary principles of fair trial and is not contrary to the public policy of Switzerland and has been rendered in a court which has established its jurisdiction vis-à-vis the relevant party on the basis of a valid submission by such party to the jurisdiction of such U.S. court. In particular a Swiss court or authority will refuse recognition and enforcement for the following reasons only, and may not otherwise review the non-Swiss judgment, including a U.S. judgment, as to its merits:

- if recognition and enforcement would be irreconcilable with Swiss public policy; or
- if a party proves that:
 - (1) it was not duly summoned pursuant to the law of its domicile or ordinary residence unless it made an appearance in proceedings without objecting to jurisdiction; or
 - (2) the decision was rendered in violation of fundamental principles of Swiss procedural law, in particular the right to be heard was not granted; or
 - (3) proceedings between the same parties in the same subject matter were first initiated or adjudicated in Switzerland, or that it was earlier adjudicated in a third country and such judgment is recognizable in Switzerland.

Further, valid submission to the jurisdiction of a foreign court, in particular a U.S. court or authority is established (i) if a provision of the PILA so provides or, in the absence of such provision, the defendant had his legal domicile in the country in which the decision was rendered; or (ii) if the parties, in a pecuniary dispute, entered into an agreement valid under the PILA submitting their dispute to the jurisdiction of the court or authority which rendered the judgment; or (iii) if the defendant, in a pecuniary dispute, proceeded on the merits without objecting to the jurisdiction; or (iv) if, in the event of a counterclaim, the court or authority which rendered the decision had jurisdiction over the principal claim and if there is a factual connection between the principal claim and the counterclaim. It is uncertain whether a Swiss court will apply this practice to default judgment as well. Swiss courts may deny the recognition and enforcement of punitive damages or other rewards.

Moreover, a Swiss court may reduce the amount of damages granted by a U.S. court and recognize damages only to the extent that they are necessary to compensate actual losses or damages. The procedure of enforcement and recognition of judgments of U.S. courts in Switzerland are governed by the provisions of the Swiss Civil Procedure Code. The judgment of a Swiss court or authority of first instance concerning recognition and enforcement of a foreign judgment, including U.S. judgments, is generally subject to appeal (at the cantonal level as well as on the federal level).

Subject to the foregoing, holders of the New Notes may be able to enforce in Switzerland judgments in civil and commercial matters obtained from United States federal or state courts; however, we cannot assure you that those judgments will be enforceable. Awards of punitive damages or other types of penalty in original actions outside Switzerland may also not be enforceable in Switzerland. Swiss civil procedure differs substantially from U.S. civil procedure in a number of respects. Insofar as the production of evidence is concerned, U.S. law and the laws of several

other jurisdictions based on common law provide for pre-trial discovery, a process by which parties to the proceedings may prior to trial compel the production of documents by adverse or third parties and the deposition of witnesses. Evidence obtained in this manner may be decisive in the outcome of any proceeding. Though there is, under certain pre-conditions, the possibility of taking evidence prior to instituting ordinary court proceedings, a pre-trial discovery process along the lines of U.S. law does not exist under Swiss law. No statement can be made as to the time and efficiency of the recognition and enforcement in Switzerland of a foreign judgment considering that recognition and enforcement proceedings tend to be time consuming in Switzerland.

Under Swiss law, any amount denominated in a foreign currency which has to be enforced through Swiss debt collection authorities (*schweizerische Zwangsvollstreckungsbehörden*) has to be converted into Swiss Francs.

Swiss law documents may be executed in English. However, in case of enforcement, the Swiss courts or any other Swiss authority may require that the transaction documents and any judgment obtained in a foreign court be translated into one of the official languages of Switzerland.

The instruction and appointment of an agent and any power of attorney may be revoked at any time under Swiss law notwithstanding the appointment, instruction or power of attorney being said to be irrevocable and any mandate may, as a matter of statutory Swiss law, be terminated at any time by each party to the mandate.

Judicial documents may not be served directly from abroad, amongst others, the United States of America to a person in Switzerland (see Switzerland's reservation to the Hague Convention on Service Abroad of Judicial or Extra-Judicial Documents in Civil and Commercial Matters concluded on 15 November 1965) and service needs to be effected by way of judicial assistance.

The Dominican Republic

The Dominican Republic is not a party to any treaties providing for reciprocal recognition and enforcement of judgments rendered in foreign courts in legal proceedings with respect to civil and commercial matters. Therefore, the Issuers have been advised by Castillo Y Castillo, their Dominican counsel, that under current applicable Dominican law, a valid final and conclusive judgment issued by a competent court located outside of the Dominican Republic would be enforced in the Dominican Republic subject to obtaining an exequatur issued by a competent court of the Dominican Republic. Based on current applicable Dominican law, the courts of the Dominican Republic should issue an exequatur in respect of a judgment obtained in a foreign court if:

- (a) such judgment complies with all formalities required for the enforceability thereof under applicable laws of the foreign jurisdiction;
- (b) has been translated into Spanish by an Official Interpreter duly authorized in the Dominican Republic, together with related documents and satisfies the authentication requirements of Dominican law;
- (c) was issued by a competent court following service of process upon the parties to the action;
- (d) was issued after an opportunity was given to the defendant to present its defense;
- (e) is final, not subject to further appeal and enforceable in the jurisdiction where the decision was rendered;
- (f) does not relate to a matter on which Dominican courts have exclusive jurisdiction;
- (g) does not refer to a matter that has been decided by a Dominican court or that is being judged by a Dominican Court; and
- (h) is not against Dominican public policy.

AUDITORS

The consolidated financial statements of Altice International as of and for the years ended December 31, 2012 and 2013 (including comparative information as of and for the year ended December 31, 2011) have been audited by Deloitte Audit S.à r.l.

The financial statements of the Senior Secured Issuer and the Senior Notes Issuer as of and for the years ended December 31, 2012 and 2013 have been audited by Deloitte Audit S.à r.l.

The standalone financial statements of PTC as of and for the years ended December 31, 2012 and 2013 have been audited by Deloitte & Associados, SROC, S.A.

The standalone financial statements of Meo, S.A. as of and for the years ended December 31, 2012 and 2013 have been audited by Deloitte & Associados, SROC, S.A.

The standalone financial statements of Orange Dominicana, S.A. as of and for the years ended December 31, 2013, and 2012 have been audited by Deloitte & Associés.

The financial statements set out below are incorporated herein by reference to Altice's website (www.altice.net/announcement.html):

The financial statements of Cabovisão—Televisão por Cabo, S.A. for the twelve-month period ended December 31, 2011 have been audited by Baker Tilly, PG & Associados, SROC, S.A. The financial statements of Cabovisão—Televisão por Cabo, S.A. for the periods ended August 31, 2012, and December 31, 2012, have been audited by Baker Tilly, PG & Associados, SROC, S.A.

The pro forma consolidated financial statements of Winreason—S.A. as of and for the twelve-month periods ended December 31, 2012 and 2011 have been audited by Deloitte & Associados, SROC S.A.

The consolidated financial statements of Groupe Outremer Telecom as and for the year ended December 31, 2012, have been audited by Constantin Associés and Ernst & Young et Autres.

The consolidated financial statements of Groupe Outremer Telecom as and for the year ended December 31, 2011, have been audited by Constantin Associés and Ernst & Young et Autres.

The financial statements of Coditel Brabant SPRL for the period of seven months ended July 31, 2011, have been audited by Deloitte Bedrijfsrevisoren/ Reviseurs d'Entreprises.

The financial statements of Coditel S.à r.l. for the seven-month period ended July 31, 2011, have been audited by Deloitte Audit S.à r.l.

The financial statements of Ma Chaîne Sport for the year ended December 31, 2012, have been audited by KPMG Audit (department de KPMG S.A.).

The financial statements of Coditel Holding as of and for the years ended December 31, 2013 and 2012 have been audited by Deloitte Audit S.à r.l.

LISTING AND GENERAL INFORMATION

Listing

Application has been made for each of the New Notes, to be listed on the Official List of the Luxembourg Stock Exchange and traded on its Euro MTF Market. All notices to holders of the New Notes, including notice of any optional redemption, Minority Shareholder Option Proceeds Offer, change of control or any change in the rate of interest payable on the New Notes, will be published on the website of the Luxembourg Stock Exchange (www.bourse.lu).

Copies of the following documents may be obtained or inspected in physical form, without charge, during usual business hours on any weekday (Saturdays, Sundays and public holidays excepted) at the registered office of the Issuers, Transfer Agent and Principal Paying Agent so long as the New Notes remain listed on the official list of the Luxembourg Stock Exchange and admitted to trading on its Euro MTF Market and the rules and regulations of such exchange require:

- (1) the articles of association of the Issuers and the Guarantors;
- (2) Altice International's annual reports and quarterly reports and consolidated financial statements required to be provided under "*Description of Senior Secured Notes—Certain Covenants—Reports*" and "*Description of Senior Notes—Certain Covenants—Reports*";
- (3) the New Indentures;
- (4) the security documents governing the Collateral;
- (5) the form of the New Notes;
- (6) the New Notes Escrow Agreements;
- (7) the Intercreditor Agreement;
- (8) the financial statements listed under "*Index to Financial Statements*", below;
- (9) the financial statements incorporated by reference under "*Presentation of Financial and Other Information—Financial Data—Issuers*", above; and
- (10) the financial statements incorporated by reference under "*Presentation of Financial and Other Information—Financial Data— Illustrative Aggregated Selected Financial Information*", above.

So long as the New notes are listed on the official list of the Luxembourg Stock Exchange and so long as the rules and regulations of such stock exchange require the Issuers will maintain a transfer agent in Luxembourg and an office or agency where Notes may be presented for transfer or exchange. The Issuers reserve the right to vary such appointment and will publish notice of such change of appointment on the website of the Luxembourg Stock Exchange (www.bourse.lu).

Pursuant to Part 1, Chapter 5, Item 502 of the rules and regulations of the Luxembourg Stock Exchange, the New Notes will be freely transferable on the Luxembourg Stock Exchange.

The net proceeds of the offering of the New Senior Secured Notes and New Senior Notes will be €2,529 million (equivalent).

Clearing Information

Dollar Senior Secured Notes

The Dollar Senior Secured Notes sold pursuant to Regulation S and to Rule 144A of the U.S. Securities Act have been accepted for clearance and settlement through the facilities of DTC and have been assigned CUSIP numbers L0178WAF9 and 02154CAD5, respectively. The ISIN for the Dollar Senior Secured Notes sold pursuant to Regulation S is USL0178WAF97 and the ISIN for the Dollar Senior Secured Notes sold pursuant to Rule 144A is US02154CAD56. The common code for the Dollar Senior Secured Notes sold pursuant to Regulation S is 118153545 and the common code for the Dollar Senior Secured Notes sold pursuant to Rule 144A is 118153502.

Euro Senior Secured Notes

The Euro Senior Secured Notes sold pursuant to Regulation S and to Rule 144A of the U.S. Securities Act have been accepted for clearance and settlement through the facilities of Clearstream and Euroclear and have been assigned common codes 118124677 and 118124723, respectively. The ISIN for the Euro Senior Secured Notes sold pursuant to Regulation S is XS1181246775 and the ISIN for the Euro Senior Secured Notes sold pursuant to Rule 144A is XS1181247237.

New Senior Notes

The New Senior Notes sold pursuant to Regulation S and to Rule 144A of the U.S. Securities Act have been accepted for clearance and settlement through the facilities of DTC and have been assigned CUSIP numbers L0179RAH5 and 02154EAD1, respectively. The ISIN for the New Senior Notes sold pursuant to Regulation S is USL0179RAH59 and the ISIN for the New Senior Notes sold pursuant to Rule 144A is US02154EAD13. The common code for the New Senior Notes sold pursuant to Regulation S is 118153731 and the common code for the New Senior Notes sold pursuant to Rule 144A is 118153600.

Legal Information

The Senior Secured Notes Issuer is incorporated under the name of Altice Financing S.A. as a public limited liability company (*société anonyme*), incorporated under the laws of the Grand Duchy of Luxembourg on August 17, 2012. The articles of association of the Senior Secured Notes Issuer have been filed with the Luxembourg Trade and Companies Register and are published in the *Mémorial C, Recueil des Sociétés et Associations* dated September 27, 2012, under number 2407, page 115493 et seq. The registered office of the Senior Secured Notes Issuer is 3, Boulevard Royal, L-2449 Luxembourg. The Senior Secured Notes Issuer's telephone number is +352 278 58 901. The Senior Secured Notes Issuer is registered with the Luxembourg Trade and Companies Register under number B171162.

The Senior Secured Notes Issuer has a share capital of €2,000,000 comprised of 2,000,000 shares with a nominal value of €1, all of which have been subscribed and fully paid-up.

According to Article 3 of the articles of association of the Senior Secured Notes Issuer relating to its corporate object, the Senior Secured Notes Issuer may carry out all transactions pertaining directly or indirectly to the taking of participating interests in any entities in whatsoever form, as well as the administration, management, control and development of such participating interests, in the Grand Duchy of Luxembourg and abroad.

The Senior Secured Notes Issuer may particularly use its funds for the setting-up, management, development and disposal of a portfolio consisting of any securities and intellectual property rights of whatever type or origin, participate in the creation, development and control of any entities, acquire by way of contribution, subscription, underwriting or by option to purchase and any other way whatsoever, any type of securities and intellectual property rights, realize them by way of sale, transfer, exchange or otherwise, have these securities and intellectual property rights developed. The Senior Secured Notes Issuer may grant assistance (by way of loans, advances, guarantees or securities or otherwise) to companies or other entities in which the Senior Secured Notes Issuer has an interest or which form part of the group of companies to which the Senior Secured Notes Issuer belongs (including shareholders or affiliated entities) or any other companies. The Senior Secured Notes Issuer may further pledge, transfer, encumber or otherwise create security over all or over some of its assets.

The Senior Secured Notes Issuer may borrow and raise funds in any form by way of public offer or exempted public offer. It may issue any kind of debt instruments (including, but not limited to notes, bonds and debentures), whether convertible or not, and/or equity securities, which may be unlisted or listed.

In general, the Senior Secured Notes Issuer may likewise carry out any financial, commercial, industrial, movable or real estate transactions, take any measures to safeguard its rights and make any transactions whatsoever which are directly or indirectly connected with its corporate object or which are liable to promote its development provided that the Senior Secured Notes Issuer will not enter into any transaction which would constitute a regulated activity of the financial sector.

The creation and issuance of the New Senior Secured Notes has been authorized by resolutions of the Board of Directors of the New Senior Secured Notes Issuer dated January 29, 2015.

The Senior Notes Issuer is incorporated under the name of Altice Finco S.A. as a public limited liability company (*société anonyme*), incorporated under the laws of Luxembourg on August 17, 2012. The articles of association of the Senior Notes Issuer have been filed with the Luxembourg Trade and Companies Register and are published in the *Mémorial C, Recueil des Sociétés et Associations* dated 28 September 2012, under number 2426, page 116402 et seq.

The registered office of the Senior Notes Issuer is 3, Boulevard Royal, L- 2449 Luxembourg. The Senior Notes Issuer's telephone number is +352 278 58 901. The Senior Notes Issuer is registered with the Luxembourg Trade and Companies Register under number B171151.

The Senior Notes Issuer has a share capital of €2,004,000 comprised of 2,004,000 shares with a nominal value of €1, all of which have been subscribed and fully paid-up.

According to Article 3 of the articles of association of the Senior Notes Issuer relating to its corporate object, the Senior Notes Issuer may carry out all transactions pertaining directly or indirectly to the taking of participating interests in any entities in whatsoever form, as well as the administration, management, control and development of such participating interests, in the Grand Duchy of Luxembourg and abroad.

The Senior Notes Issuer may particularly use its funds for the setting- up, management, development and disposal of a portfolio consisting of any securities and intellectual property rights of whatever type or origin, participate in the creation, development and control of any entities, acquire by way of contribution, subscription, underwriting or by option to purchase and any other way whatsoever, any type of securities and intellectual property rights, realize them by way of sale, transfer, exchange or otherwise, have these securities and intellectual property rights developed. The Senior Notes Issuer may grant assistance (by way of loans, advances, guarantees or securities or otherwise) to companies or other entities in which the Senior Notes Issuer has an interest or which form part of the group of companies to which the Senior Notes Issuer belongs (including shareholders or affiliated entities) or any other companies. The Senior Notes Issuer may further pledge, transfer, encumber or otherwise create security over all or over some of its assets.

The Senior Notes Issuer may borrow and raise funds in any form by way of public offer or exempted public offer. It may issue any kind of debt instruments (including, but not limited to notes, bonds and debentures), whether convertible or not, and/or equity securities, which may be unlisted or listed.

In general, the Senior Notes Issuer may likewise carry out any financial, commercial, industrial, movable or real estate transactions, take any measures to safeguard its rights and make any transactions whatsoever which are directly or indirectly connected with its corporate object or which are liable to promote its development provided that the Senior Notes Issuer will not enter into any transaction which would constitute a regulated activity of the financial sector.

The creation and issuance of the New Senior Notes has been authorized by resolutions of the Board of Directors of the Senior Notes Issuer dated January 29, 2015.

Cool Holding was incorporated in Israel under the name of Cool Holding Ltd. on April 26, 2009. The registered office of Cool Holding in Israel is 16 Abba Hillel Rd., Ramat-Gan 52506, Israel. Cool Holding is registered with the Israeli corporate registrar under number Israeli registration number 51-426602-2. On April 2, 2010, the general meeting of Cool Holding's equity holders approved Cool Holding's registration as a public limited liability company (*société anonyme*) in Luxembourg. The articles of association of Cool Holding have been filed with the Luxembourg Trade and Companies Register and are published in the *Mémorial C, Recueil des Sociétés et Associations* dated May 20, 2010, under number 1060, page 50862 et seq. The registered office of Cool Holding in Luxembourg is 3, Boulevard Royal, L- 2449 Luxembourg. Cool Holding's telephone number is +352 278 58 901. Cool Holding is registered with the Luxembourg Trade and Companies Register under number B152495. According to its articles of association, Cool Holding's principal place of management and control is Luxembourg. Cool Holding is subject to both Luxembourg laws and Israeli laws and is deemed to have a dual nationality.

According to Article 2.5 of the articles of association of Cool Holding relating to its corporate purpose, the purpose of Cool Holding is to take participations, in any form whatsoever, in any commercial, industrial, financial or other Luxembourg or foreign enterprises; to acquire any securities and rights through participation, contribution, option or in any other way.

Cool Holding may use its funds to invest in real estate, to establish, manage, develop and dispose of its assets as they may be composed from time to time and namely but not limited to, its portfolio of securities of whatever origin, to participate in the creation, development and control of any enterprise, to acquire, by way of investment, subscription, underwriting or option, securities, and any intellectual property rights, to realize them by way of sale, transfer, exchange or otherwise, to receive or grant licenses on intellectual property rights and to grant to or for the benefit of companies in which Cool Holding has a direct or indirect participation, to any companies being shareholder of Cool Holding, to companies being owned by a shareholder of Cool Holding and to companies of the group, any assistance including financial assistance, loans, advances or guarantees.

Without prejudice to the generality of the object of Cool Holding, this latter may do all or any of the following:

- (i) to take, manage and sell participation in other companies by way of acquisition, possession, administration, sale, exchange, transfer, trade, investment in and alienation of shares, bonds, funds, notes, evidences of indebtedness, debentures, certificates and other securities;
- (ii) to borrow money in any form or to obtain any form of credit facility and raise funds through, including, but not limited to, the issue of bonds, notes, promissory notes, certificates and other debt or equity instruments, convertible or not, or the use of financial derivatives or otherwise;
- (iii) to advance, lend or deposit money or give credit to or with or to subscribe to or purchase any debt instrument issued by any Luxembourg or foreign entity on such terms as may be thought fit and with or without security;
- (iv) to enter into any guarantee, pledge or any other form of security, whether by personal covenant or by mortgage or charge upon all or part of the undertaking, property assets (present or future) or by all or any of such methods, for the performance of any contracts or obligations of Cool Holding and of any of connected companies, or any director, manager or other agent of Cool Holding or any of connected companies, within the limits of any applicable law provision; and
- (v) to enter into any agreements, including, but not limited to partnership agreements, underwriting agreements, marketing agreements, management agreements, advisory agreements, administration agreements, cooperation agreement and other services contracts, selling agreements, interest and/or currency exchange agreements and other financial derivative agreements in relation to its object.
- (vi) to acquire income arising from the disposal or licensing of copyrights, patents, designs, secret processes, trademarks or other similar interests;
- (vii) to render technical assistance to other companies;

It being understood that Cool Holding will not enter into any transaction which would cause it to be engaged in any activity that would be considered as a regulated activity of the financial sector.

In a general fashion, Cool Holding may carry out any operation, which it may deem useful in the accomplishment and development of its purposes.

Cool Holding has a share capital of NIS 6,147,657 (six million one hundred forty seven thousand six hundred fifty seven shekels) divided into 6,147,657 (six million one hundred forty seven thousand six hundred fifty seven) ordinary shares, with a nominal value of NIS 1.00 (one shekel) each.

SPV1 was incorporated in Israel under the name of H.Hadaros 2012 Ltd. on March 22, 2012. The registered office of SPV1 is 16 Abba Hillel Rd., Ramat Gan, 52506, Israel. SPV1 is registered with the Israeli Registrar of Companies under number 51-475212-0.

According to its Articles of Association, SPV1's corporate objectives are to carry on any legal business. SPV1 has a share capital of NIS 100,000 comprised of 10,000,000 ordinary shares with a par value of NIS 0.10 per ordinary share, of which 100 ordinary shares are issued and outstanding.

Altice Holdings is incorporated under the name Altice Holdings S.à r.l. as a private limited liability company (*société à responsabilité limitée*), incorporated under the laws of Luxembourg on January 31, 2013. The articles of association of Altice Holdings have been filed with the Luxembourg Trade and Companies Register and one published in the *Mémorial C, Recueil des Sociétés et Associations* dated 23 March 2013 under number 717, page 34394 *et seq.* The registered office of Altice Holdings S.à r.l. is 3, Boulevard Royal, L-2449 Luxembourg. Altice Holdings' telephone number is +352 278 58 901. Altice Holdings is registered with the Luxembourg Trade and Companies Register under number B174906.

Altice Holdings has a share capital of €2,378,000 comprised of 2,378,000 shares with a nominal value of €1, all of which have been subscribed and fully paid-up.

According to Article 3 of the articles of association of Altice Holdings may carry out all transactions pertaining directly or indirectly to the taking of participating interests in any enterprises in whatever form, as well as the administration, management, control and development of such participating interests, in the Grand Duchy of Luxembourg and abroad.

Altice Holdings may particularly use its funds for the setting-up, management, development and disposal of a portfolio consisting of any securities and intellectual property rights of whatever type or origin, participate in the creation, development and control of any enterprises, acquire by way of contribution, subscription, underwriting or by option to

purchase and any other way whatsoever, any type of securities and intellectual property rights, realize them by way of sale, transfer, exchange or otherwise, have these securities and intellectual property rights developed. Altice Holdings may grant assistance (by way of loans, advances, guarantees or securities or otherwise) to companies or other enterprises in which Altice Holdings has an interest or which form part of the group of companies to which Altice Holdings belongs (including shareholders or affiliated entities) or any other companies. Altice Holdings may further pledge, transfer, encumber or otherwise create security over all or over some of its assets.

Altice Holdings may borrow in any form except by way of public offer (to the extent prohibited by any applicable law). It may issue by way of private placement only, notes, bonds and debentures and any kind of debt, whether convertible or not, and/or equity securities.

In general, Altice Holdings may likewise carry out any financial, commercial, industrial, movable or real estate transactions, take any measures to safeguard its rights and make any transactions whatsoever which are directly or indirectly connected with its purpose or which are liable to promote their development.

Altice Portugal (formerly known as Rightproposal—Telecomunicações, S.A.) was incorporated as a public limited liability company (*sociedade anónima*) under the laws of Portugal on February 27, 2012. Altice Portugal is registered under the registration number 510 160 549. The registered office of Altice Portugal is Rua do Alecrim, 26-E, 1200-018 Lisboa, Portugal. Altice Portugal's telephone number is +351 210 810 505.

Altice Portugal has a share capital of €50,000.00 comprised of 50,000 shares with a nominal value of €1.00 each, all of which have been subscribed and fully paid-up.

According to Article 2 of Altice Portugal's articles of association, the company's purpose is the installation, operation, marketing and technical assistance of systems of image transmission and cable television signal, establishment, management and operation of infrastructure and telecommunications systems, the provision of telecommunications services and/or television, or directly or indirectly related to them, whatever the system or physical way of transmission, the marketing or the provision of multimedia services or audiovisual media, of all kind, by transmission of cable television or other.

Pursuant to article 3 of Altice Portugal's articles of association, Altice Portugal may also purchase and sell or encumber holdings in companies with different corporate purposes, in companies governed by specific regulations, in complementary group of companies (*agrupamento complementar de empresas*) and in foreign companies or entities.

In general, Altice Portugal may carry out any transaction, which it may deem necessary or convenient in the accomplishment and development of its purposes, save to the extent prohibited by law.

Cabovisão was incorporated as a public limited liability company (*sociedade anónima*) under the laws of Portugal on September 27, 1993. Cabovisão is registered with the Commercial Registry Office of Palmela under the registration number 503 062 081. The articles of association of Cabovisão were filed with the Commercial Registry Office of Palmela and were published in the Official Gazette (*Diário da República*). The registered office of Cabovisão is Lugar de Poços, Vale de Touros, Palmela, Portugal. Cabovisão's telephone number is +351 210 810 505.

Cabovisão has a share capital of €5,000,040.00 comprised of 2,500,020 shares with a nominal value of €2.00 each, all of which have been subscribed and fully paid-up.

According to Article $\frac{3}{1}$ of Cabovisão's articles of association, the company's purpose is the installation, operation, marketing and technical assistance for images transmitting systems and cable television signals, the provision of telecommunications and/or television services, or directly or indirectly related to them, for all systems or physical transmission mediums, marketing or provision of media or television services, of all kind, by cable TV transmission network or other.

Pursuant to article $\frac{3}{2}$ of Cabovisão's articles of association, Cabovisão may, by resolution of the Board of Directors, purchase shareholdings in companies with different corporate purposes or governed by specific regulations, as well as enter into association with other legal entities through European groups of companies of economic interest (*agrupamentos europeus de interesse económico*), complementary groups of companies (*agrupamentos complementares de empresas*), consortia or partnerships (*associações em participação*).

In general, Cabovisão may carry out any transaction, which it may deem necessary or convenient in the accomplishment and development of its purposes, save to the extent prohibited by law.

Altice International exists under the name of Altice International S.à r.l., a public limited liability company (*société anonyme*), incorporated under the laws of the Grand Duchy of Luxembourg on December 15, 2008 (originally

incorporated under the form of a *société à responsabilité limitée*). The articles of association of Altice International have been filed with the Luxembourg Trade and Companies Register and are published in the *Mémorial C, Recueil des Sociétés et Associations* dated 19 January 2009, under number 112, page 5353 *et seq.* The registered office of Altice International is 3, Boulevard Royal, L-2449 Luxembourg. Altice International's telephone number is +352 278 58 901. Altice International is registered with the Luxembourg Trade and Companies Register under number B143725.

Altice International has a share capital of €309,257,000 comprised of 30,925,700,000 shares with a nominal value of €0.01, all of which have been subscribed and fully paid up.

According to Article 3 of the articles of association of Altice International relating to its corporate object, Altice International may carry out all transactions pertaining directly or indirectly to the taking of participating interests in any enterprises in whatever form, as well as the administration, management, control and development of such participating interests, in the Grand Duchy of Luxembourg and abroad.

Altice International may particularly use its funds for the setting-up, management, development and disposal of a portfolio consisting of any securities and intellectual property rights of whatever type or origin, participate in the creation, development and control of any enterprises, acquire by way of contribution, subscription, underwriting or by option to purchase and any other way whatsoever, any type of securities and intellectual property rights, realize them by way of sale, transfer, exchange or otherwise, have these securities and intellectual property rights developed. Altice International may grant assistance (by way of loans, advances, guarantees or securities or otherwise) to companies or other enterprises in which Altice International has an interest or which form part of the group of companies to which Altice International belongs (including shareholders or affiliated entities) or any other companies. Altice International may further pledge, transfer, encumber or otherwise create security over all or over some of its assets.

Altice International may borrow in any form except by way of public offer (to the extent prohibited by any applicable law). It may issue by way of private placement only, notes, bonds and debentures and any kind of debt, whether convertible or not, and/or equity securities.

In general, Altice International may likewise carry out any financial, commercial, industrial, movable or real estate transactions, take any measures to safeguard its rights and make any transactions whatsoever which are directly or indirectly connected with its purpose or which are liable to promote their development.

Altice West Europe is incorporated under the name of Altice West Europe S.à r.l. as a private limited liability company (*société à responsabilité limitée*), incorporated under the laws of Luxembourg on June 5, 2013. Altice West Europe is incorporated under the name Altice West Europe S.à r.l. as a private limited liability company (*société à responsabilité limitée*), incorporated under the laws of Luxembourg on June 5, 2013. The articles of association of Altice West Europe have been filed with the Luxembourg Trade and Companies Register and one published in the *Mémorial C, Recueil des Sociétés et Associations* dated 3 August 2013 under number 1879, page 90161 *et seq.* The registered office of Altice West Europe S.à r.l. is 3, Boulevard Royal, L-2449 Luxembourg. Altice West Europe's telephone number is +352 278 58 901. Altice West Europe is registered with the Luxembourg Trade and Companies Register under number B178.002.

Altice West Europe has a share capital of €2,377,000 comprised of 2,377,000 shares with a nominal value of €1, all of which have been subscribed and fully paid-up.

According to Article 3 of the articles of association of Altice West Europe relating to its corporate object, Altice West Europe may carry out all transactions pertaining directly or indirectly to the taking of participating interests in any enterprises in whatever form, as well as the administration, management, control and development of such participating interests, in the Grand Duchy of Luxembourg and abroad.

Altice West Europe may particularly use its funds for the setting-up, management, development and disposal of a portfolio consisting of any securities and intellectual property rights of whatever type or origin, participate in the creation, development and control of any enterprises, acquire by way of contribution, subscription, underwriting or by option to purchase and any other way whatsoever, any type of securities and intellectual property rights, realize them by way of sale, transfer, exchange or otherwise, have these securities and intellectual property rights developed. Altice West Europe may grant assistance (by way of loans, advances, guarantees or securities or otherwise) to companies or other enterprises in which Altice West Europe has an interest or which form part of the group of companies to which Altice West Europe belongs (including shareholders or affiliated entities) or any other companies. Altice West Europe may further pledge, transfer, encumber or otherwise create security over all or over some of its assets.

Altice West Europe may borrow in any form except by way of public offer (to the extent prohibited by any applicable law). It may issue by way of private placement only, notes, bonds and debentures and any kind of debt, whether convertible or not, and/or equity securities.

In general, Altice West Europe may likewise carry out any financial, commercial, industrial, movable or real estate transactions, take any measures to safeguard its rights and make any transactions whatsoever which are directly or indirectly connected with its purpose or which are liable to promote their development.

Altice Caribbean is incorporated under the name of Altice Caribbean S.à r.l. as a private limited liability company (*société à responsabilité limitée*), incorporated under the laws of Luxembourg on October 4, 2012. The articles of association of Altice Caribbean have been filed with the Luxembourg Trade and Companies Register and are published in the *Mémorial C, Recueil des Sociétés et Associations* dated 22 November 2012, under number 2833, page 135972 et seq. The registered office of Altice Caribbean is 3, Boulevard Royal, L-2449 Luxembourg. Altice Caribbean's telephone number is +352 278 58 901. Altice Caribbean is registered with the Luxembourg Trade and Companies Register under number B172223.

Altice Caribbean has a share capital of €13,000 comprised of 13,000 shares with a nominal value of €1, all of which have been subscribed and fully paid-up.

According to Article 3 of the articles of association of Altice Caribbean relating to its corporate object, Altice Caribbean may carry out all transactions pertaining directly or indirectly to the taking of participating interests in any enterprises in whatever form, as well as the administration, management, control and development of such participating interests, in the Grand Duchy of Luxembourg and abroad.

Altice Caribbean may particularly use its funds for the setting-up, management, development and disposal of a portfolio consisting of any securities and intellectual property rights of whatever type or origin, participate in the creation, development and control of any enterprises, acquire by way of contribution, subscription, underwriting or by option to purchase and any other way whatsoever, any type of securities and intellectual property rights, realize them by way of sale, transfer, exchange or otherwise, have these securities and intellectual property rights developed. Altice Caribbean may grant assistance (by way of loans, advances, guarantees or securities or otherwise) to companies or other enterprises in which Altice West Europe has an interest or which form part of the group of companies to which Altice Caribbean belongs (including shareholders or affiliated entities) or any other companies. Altice Caribbean may further pledge, transfer, encumber or otherwise create security over all or over some of its assets.

Altice Caribbean may borrow in any form except by way of public offer (to the extent prohibited by any applicable law). It may issue by way of private placement only, notes, bonds and debentures and any kind of debt, whether convertible or not, and/or equity securities.

In general, Altice Caribbean may likewise carry out any financial, commercial, industrial, movable or real estate transactions, take any measures to safeguard its rights and make any transactions whatsoever which are directly or indirectly connected with its purpose or which are liable to promote their development.

Altice Bahamas was incorporated under the name "Altice SEE S.à r.l." as a private limited liability company (*société à responsabilité limitée*), incorporated under the laws of Luxembourg on October 14, 2013. On November 11, 2013, the company changed its name to "Altice Bahamas S.à r.l." and raised its share capital from an amount of EUR 12,500 to EUR 20,000 (\$26,729). The articles of association of Altice Bahamas have been filed with the Luxembourg Trade and Companies Register and are published in the *Mémorial C, Recueil des Sociétés et Associations* dated December 24, 2013 under number 3286, page 157700 et seq. The registered office of Altice Bahamas S.à r.l. is 3, Boulevard Royal, L 2449 Luxembourg. Altice Bahamas' telephone number is +352 226 05 640. Altice Bahamas is registered with the Luxembourg Trade and Companies Register under number B181590.

Altice Bahamas has a share capital of \$4,614,530.71 comprised of 448,532,385 Class A Shares and 12,920,686 Class B Shares with a nominal value of \$0.01, all of which have been subscribed and fully paid up.

According to Article 3 of the articles of association of Altice Bahamas may carry out all transactions pertaining directly or indirectly to the taking of participating interests in any enterprises in whatever form, as well as the administration, management, control and development of such participating interests, in the Grand Duchy of Luxembourg and abroad.

Altice Bahamas may particularly use its funds for the setting up, management, development and disposal of a portfolio consisting of any securities and intellectual property rights of whatever type or origin, participate in the creation, development and control of any enterprises, acquire by way of contribution, subscription, underwriting or by option to purchase and any other way whatsoever, any type of securities and intellectual property rights, realize them by way of sale, transfer, exchange or otherwise, have these securities and intellectual property rights developed. Altice Bahamas may grant assistance (by way of loans, advances, guarantees or securities or otherwise) to companies or other enterprises in which Altice Bahamas has an interest or which form part of the group of companies to which Altice Bahamas belongs (including shareholders or affiliated entities) or any other companies. Altice Bahamas may further pledge, transfer, encumber or otherwise create security over all or over some of its assets.

Altice Bahamas may borrow in any form except by way of public offer (to the extent prohibited by any applicable law). It may issue by way of private placement only, notes, bonds and debentures and any kind of debt, whether convertible or not, and/or equity securities.

In general, Altice Bahamas may likewise carry out any financial, commercial, industrial, movable or real estate transactions, take any measures to safeguard its rights and make any transactions whatsoever which are directly or indirectly connected with its purpose or which are liable to pro-mote their development.

Altice Hispaniola, S.A. (“ODO”) is a limited liability corporation (*sociedad anónima*) incorporated under the laws of the Dominican Republic on July 5, 1993. The bylaws of ODO have been filed and registered at the Mercantile Registry of the Santo Domingo Chamber of Commerce and Production, under Mercantile Registration number 4895SD, issued on September 4, 2002. The registered office of ODO is Avenida Núñez de Cáceres No. 8, GINAKA Building, Bella Vista, Santo Domingo, National District, Dominican Republic. ODO’s telephone number is +1 809 859 1000. ODO is registered at the Dominican Directorate General of Internal Taxes (Dirección General de Impuestos Internos—DGII) under National Taxpayer’s Registration number (Registro Nacional de Contribuyentes—RNC) 1-01-61878-7.

ODO has a share capital of RD\$5,800,000,000.00 comprised of 58,000,000 shares with a nominal value of RD\$100 each. All of ODO’s shares have been subscribed and fully paid in.

According to Article 2 of ODO’s Bylaws relating to its corporate object, ODO may perform general telecommunications activities in the Dominican Republic or abroad, including, but not limited to, activities related or connected with the transmission of voice, data, internet and television without any kind of restriction with respect to the kind of technology used, as well as all kinds of activities related with the main purpose and those activities of lawful trade.

The granting of the senior secured guarantees will be authorized by resolutions of ODO’s General Extraordinary Shareholder’s Meeting prior to the granting of such guarantees.

Tricom, S.A. (“Tricom”) is a limited liability corporation (*sociedad anónima*) incorporated under the laws of the Dominican Republic on January 25, 1988. The bylaws of Tricom have been filed and registered at the Mercantile Registry of the Santo Domingo Chamber of Commerce and Production, under Mercantile Registration number 4759SD, issued on July 13, 2000. The registered office of Tricom is Autopista Duarte, Km. 11^{1/2}, Esq. Avenida Monumental, Santo Domingo Oeste, Santo Domingo Province, Dominican Republic. Tricom’s telephone number is +1 809 476 6000. Tricom is registered at the Dominican Directorate General of Internal Taxes (Dirección General de Impuestos Internos—DGII) under National Taxpayer’s Registration number (Registro Nacional de Contribuyentes—RNC) 1-01-50252-5.

Tricom has a share capital of RD\$8,000,000,000.00 comprised of 80,000,000 shares with a nominal value of RD\$100 each, of which 79,998,936 have been subscribed and fully paid in.

According to Article 3 of Tricom’s Bylaws relating to its corporate object, Tricom may provide, install, service, maintain and operate telecommunication systems in the Dominican Republic and in other countries, which will be constructed, maintained and operated by the company as set forth in the agreements, contracts and licenses granted in its favor by the corresponding regulatory authorities, as well as those systems whose construction, maintenance and operation is granted to it in the future under any other agreement, contract or license.

Tricom may negotiate the necessary agreements for the interconnection to the public switched telephone network, as well as national networks dedicated to interurban service, as required by said telecommunications systems.

Tricom may construct, maintain and exploit a private telecommunications system for the transmission of national and international calls and for the transmission and reception of messages and signals of any kind.

Likewise, Tricom may provide, install, service, maintain and operate television signals transmission systems through networks or coaxial cabling or by any other means allowed by the corresponding authorities in the Dominican Republic and in other countries, which will be constructed, maintained and operated by the company as set forth in the agreements, contracts and licenses granted in its favor by the corresponding regulatory authorities, as well as those systems whose construction, maintenance and operation is granted to it in the future under any other agreement, contract or license.

In general, Tricom may undertake any financial, technical, industrial, commercial, movable, real estate transactions and any other business or activity of lawful trade, without any limitation, except for those imposed by applicable laws.

The granting of the senior secured guarantees will be authorized by resolutions of Tricom’s General Extraordinary Shareholder’s Meeting prior to the granting of such guarantees.

Winreason was incorporated as a public limited liability company (*sociedade anónima*) under the laws of Portugal on November 8, 2006. Winreason is registered with the Commercial Registry Office of Lisbon under the registration number 507 931 726. The registered office of Winreason is Avenida Fontes Pereira de Melo, no. 27, 1069-447 Lisbon, Portugal.

Winreason has a share capital of €12,000,000, comprised of 12,000,000 shares with a nominal value of €1.00 each, all of which have been subscribed and fully paid up. Of the 12,000,000 shares which represent Winreason's share capital, 11,700,000 shares are ordinary shares and 300,000 shares are Class A shares. The favorable vote of at least two thirds of the Class A shares is necessary for approving modifications to Winreason's corporate purpose and the transformation or dissolution of Winreason.

According to Article $\frac{3}{1}$ of Winreason's articles of association, the company's purpose is to set-up, manage and operate telecommunication infrastructures and systems, render telecommunication services and carry out any activities which are complementary, subsidiary or accessory to the aforementioned activities.

Pursuant to Article $\frac{3}{3}$ of Winreason's articles of association, Winreason may purchase and sell shareholdings in companies with different corporate purpose or companies governed by specific regulations, whether the same imply limited or unlimited liability to their respective shareholders, as well as enter into association with other legal entities through complementary groups of companies (*agrupamentos complementares de empresas*), European groups of economic interest (*agrupamentos europeus de interesse económico*), new companies (regardless of whether the same imply limited or unlimited liability to their respective shareholders), consortia or partnerships (*associações em participação*) and, likewise, incorporate or participate in any other forms of association, whether temporary or permanent, between companies and/or public or private entities.

In general, Winreason may carry out any transaction, which it may deem necessary or convenient in the accomplishment and development of its purposes, save to the extent prohibited by law.

ONI S.G.P.S was incorporated as a public limited liability company (*sociedade anónima*) under the laws of Portugal on September 19, 2005. ONI S.G.P.S is registered with the Commercial Registry Office of Cascais under the registration number 504 968 386. The registered office of ONI S.G.P.S is Avenida Fontes Pereira de Melo, no. 27, 1069-447 Lisbon, Portugal.

ONI S.G.P.S has a share capital of €100,000,000.10, comprised of 526,315,790 shares with a nominal value of €0.19 each, all of which have been subscribed and fully paid up.

According to Article 3 of ONI S.G.P.S's articles of association, the company's purpose is to manage participations in other companies as an indirect form of economic activity.

In general, ONI S.G.P.S may carry out any transaction, which it may deem necessary or convenient in the accomplishment and development of its purposes, save to the extent prohibited by law (notably, the limitations included in Decree Law No. 495/88, of December 30, 1988, as amended from time to time, which regulates Portuguese law holding companies (*sociedades gestoras de participações sociais*)).

Onitelecom was incorporated as a public limited liability company (*sociedade anónima*) under the laws of Portugal on August 28, 2003. Onitelecom is registered with the Commercial Registry Office of Lisbon under the registration number 504 073 206. The registered office of Onitelecom is Avenida Fontes Pereira de Melo, no. 27, 1069-447 Lisbon, Portugal.

Onitelecom has a share capital of €4,680,000.00, comprised of 4,680,000 shares with a nominal value of €1.00 each, all of which have been subscribed and fully paid up. Of the 4,680,000 shares which represent Onitelecom's share capital, 4,541,100 shares are ordinary shares and 138,900 shares are preferred non-voting shares entitling the owner thereof to a preferred dividend of €0.05 each financial year.

According to Article 4 of Onitelecom's articles of association, the company's purpose is to set-up, manage and operate telecommunication infrastructures and systems, render telecommunication services and carry out any activities which are complementary, subsidiary or accessory to the aforementioned activities, directly or through the incorporation or participation in other companies.

Pursuant to Article 5 of Onitelecom's articles of association, Onitelecom may associate with other entities in order for, notably, incorporating companies, whether the same imply limited or unlimited liability to their respective shareholders, complementary groups of companies (*agrupamentos complementares de empresas*), consortia or partnerships (*associações em participação*), as well as freely acquire and dispose of shareholdings in other companies, even if the

same are limited liability companies or governed by specific regulations or the corporate purpose of such entities does not have any direct or indirect relationship with Onitelecom's corporate purpose.

In general, Onitelecom may carry out any transaction, which it may deem necessary or convenient in the accomplishment and development of its purposes, save to the extent prohibited by law.

Knewon was incorporated as a public limited liability company (*sociedade anónima*) under the laws of Portugal on July 2, 2009. Knewon is registered with the Commercial Registry Office of Lisbon under the registration number 508 989 787. The registered office of Knewon is Avenida Fontes Pereira de Melo, no. 27, 1069-447 Lisbon, Portugal.

Knewon has a share capital of €100,000.00 comprised of 100,000 shares with a nominal value of €1.00 each.

According to Article 4 of Knewon's articles of association, the company's purpose is: the exclusive rendering of private security services (notably the operation and management of alarm and video surveillance control centers); the installation, commercialization and maintenance of electronic security equipment; the installation, commercialization and maintenance of fire detection and suppression systems; conducting electric installations related to electronic security equipment and fire detection and suppression equipment; and the installation of electronic surveillance systems, as well as any other activities which may have a complementary, subsidiary or related nature to the aforementioned activities.

Pursuant to Article 5 of Knewon's articles of association, Knewon may associate with other entities in order for, notably, incorporating companies, complementary groups of companies (*agrupamentos complementares de empresas*), consortia or partnerships (*associações em participação*), as well as freely acquire and dispose of shareholdings in other companies, even if the same are limited liability companies or governed by specific regulations or the corporate purpose of such entities does not have any direct or indirect relationship with Knewon's corporate purpose.

In general, Knewon may carry out any transaction which it may deem necessary or convenient in the accomplishment and development of its purposes, save to the extent prohibited by law.

PT Portugal was incorporated as a public limited liability company (*sociedade anónima*) under the laws of Portugal on March 29, 2006. PT Portugal is registered with the Commercial Registry Office of Lisbon under the registration number 507 690 737. The registered office of PT Portugal is Avenida Fontes Pereira de Melo, no. 40, 1069-300 Lisbon, Portugal.

PT Portugal has a share capital of €3,450,000,000.00, comprised of 50,000 shares with a nominal value of €69,000.00 each, all of which have been subscribed and fully paid up.

According to Article 3 of PT Portugal's articles of association, the company's purpose is the management of participations in other companies as an indirect form of economic activity.

In general, PT Portugal may carry out any transaction, which it may deem necessary or convenient in the accomplishment and development of its purposes, save to the extent prohibited by law (notably, the limitations included in Decree Law No. 495/88, of December 30, 1988, as amended from time to time, which regulates Portuguese law holding companies (*sociedades gestoras de participações sociais*)).

PT OpCo is the surviving entity following the merger between PTC and Meo, S.A. PT OpCo was incorporated as a public limited liability company (*sociedade anónima*) under the laws of Portugal on September 18, 2000. PT OpCo is registered with the Commercial Registry Office of Lisbon under the registration number 504 615 947. The registered office of PT OpCo is Av. Fontes Pereira de Melo, no. 40, 1050-123 Lisbon, Portugal.

PT OpCo has a share capital of €1,150,000,000.00, comprised of 1,150,000,000 shares with a nominal value of €1.00 each, all of which have been subscribed and fully paid up.

According to Article ³/₁ of PT OpCo's articles of association, the company's purpose is the design, construction, management and exploitation, of electronic communication networks and infrastructures, rendering of electronic communication services, transport and broadcasting of telecommunication broadcast signal and television activities. Furthermore, pursuant to Article ³/₂ of PT OpCo's articles of association, the company also has as its purpose the rendering of services in the areas of IT systems, information society, media and communication, development and commercialization of electronic communication, IT and communication products and equipment, e-commerce activities, including online auctions and formation and consulting services within its corporate purpose. PT OpCo may also carry out any activities which are complementary, subsidiary or accessory to the aforementioned, directly or by incorporating or having ownership of other companies.

Pursuant to Article ³/₄ of PT OpCo's articles of association, PT OpCo may, by resolution of the Board of Directors, purchase and sell shareholdings in companies with different corporate purposes or governed by specific regulations, as well as enter into association with other legal entities through complementary groups of companies (agrupamentos complementares de empresas), European groups of economic interest (agrupamentos europeus de interesse económico), new companies, consortia or partnerships (associações em participação) and, likewise, incorporate or participate in any other forms of association, whether temporary or permanent, between companies and/or public or private entities.

In general, PT OpCo may carry out any transaction, which it may deem necessary or convenient in the accomplishment and development of its purposes, save to the extent prohibited by law.

Green is incorporated under the name green.ch AG (formerly known as Solution25 AG and registered under the business identification number CH-170.3.030.640-6) as a company limited by shares (Aktiengesellschaft), incorporated under the laws of Switzerland on April 17, 2007. The articles of association of Green have been filed with, and may be requested from, the Commercial Register of the Canton of Aargau. The registered office of Green is Badstrasse 50, CH-5200 Brugg, Switzerland. Green's telephone number is +41 0844 842 842. Green is registered with the Commercial Register of the Canton of Aargau under the business identification number CHE-113.574.742.

Green has a share capital of CHF 29,400,000 comprised of 193,337 ordinary registered shares (Stamm-Namenaktien) and 29,206,663 preferred registered shares (Vorzugs-Namenaktien), each with a nominal value of CHF 1.00, all of which have been subscribed and fully paid up.

According to Article 2 of the articles of association of Green, the company's corporate purpose is to render services and pursue developments, in particular in the areas of computer science, telecommunications, IT, software and applications, the trading and distributing of goods of all kind, in particular technical products, the direct and indirect acquisition, management and disposal of other businesses, the financing for its own and other account, especially the financing of holding companies, and to provide guarantees and sureties for shareholders, related companies and third parties.

Green can acquire infrastructural facilities, patents, licenses and other intangible assets as well as acquire, manage and dispose of real estate and set up branches. Green can acquire, manage, create a pledge over and dispose of real estate in Switzerland or abroad.

In general, Green may carry out any business, as well as any commercial, financial or other transaction, which is deemed necessary or relevant in furtherance of the company's business activities.

Global Interlink Ltd. was incorporated in The Bahamas on September 9, 2010 under the International Business Companies Act, 2000 (as amended) of The Bahamas. The registered agent of the company in The Bahamas is H & J Corporate Services Ltd. and its registered office in The Bahamas is located at Ocean Centre, Montague Foreshore, East Bay Street, P.O. Box SS-19084, Nassau, Bahamas, telephone number +1 242 502 5200. Global Interlink Ltd. is registered in the Register of Companies by the Registrar of Companies in The Bahamas under company registration number 160,205B.

Global Interlink Ltd. has an authorized share capital of US\$1,000.00 divided into 100 shares of US\$10.00 par value each. All of the shares in the capital of the company have been issued.

The Memorandum of Association of Global Interlink Ltd. at paragraph 4 thereof provides that:

- (1) The objects for which the Company is established are to engage in any act or activity that is not prohibited under any law for the time being in force in The Bahamas.
- (2) The Company shall have all such powers as are permitted by any law for the time being in force in The Bahamas, irrespective of corporate benefit, to perform all acts and engage in all activities necessary or conducive to the conduct, promotion or attainment of the objects or purposes of the Company.
- (3) The directors may by resolution of directors exercise all the powers of the Company to borrow money and to mortgage or charge its undertakings and property or any part thereof to issue debentures, debenture stock and other securities whenever money is borrowed or as security for any debt, liability or obligation of the Company or of any third party.
- (4) Any mortgage or charge of the undertaking and property of the Company shall for the purpose of Section 80 of the Act be regarded as in the usual or regular course of the business carried on by the Company.

Management

Each Issuer is managed by a board of directors composed of three (3) members being:

1. Mr. Jérémie BONNIN (chairman);
2. Ms. Emilie SCHMITZ; and
3. Mr. Laurent GODINEAU.

Cool Holding is managed by a board of directors composed of three (3) members being:

1. Mr. Jérémie BONNIN (chairman);
2. Ms. Emilie SCHMITZ; and
3. Mr. Laurent GODINEAU.

SPV1 is managed by a board of directors of which Cool Holding is the sole member.

As of the date of these Listing Particulars, Altice Portugal is managed by a board of directors composed of three (3) members being:

1. Mr. Armando PEREIRA (chairman);
2. Mr. Jérémie BONNIN; and
3. Mr. Dexter GOEI.

As of the date of these Listing Particulars, Cabovisão is managed by a board of directors composed of four (4) members being:

1. Mr. Armando PEREIRA (chairman);
2. Mr. Jérémie BONNIN;
3. Mr. Dexter GOEI; and
4. Mr. François Jean MARC-ANTOINE VAUTHIER.

As of the date of these Listing Particulars, Altice Holdings is managed by a board of managers composed of three (3) members being:

1. Mr. Jérémie BONNIN;
2. Ms. Emilie SCHMITZ; and
3. Mr. Laurent GODINEAU.

As of the date of these Listing Particulars, Altice International is managed by a board of managers composed of three (3) members being:

1. Mr. Jérémie BONNIN;
2. Ms. Emilie SCHMITZ; and
3. Mr. Laurent GODINEAU

As of the date of these Listing Particulars, Altice West Europe is managed by a board of managers composed of three (3) members being:

1. Mr. Jérémie BONNIN;

2. Ms. Emilie SCHMITZ; and
3. Mr. Laurent GODINEAU.

As of the date of these Listing Particulars, Altice Caribbean is managed by a board of managers composed of three (3) members being:

1. Mr. Jérémie BONNIN;
2. Ms. Emilie SCHMITZ; and
3. Mr. Laurent GODINEAU.

As of the date of these Listing Particulars, Altice Bahamas is managed by a board of managers composed of three (3) members being:

1. Mr. Jérémie BONNIN;
2. Ms. Emilie SCHMITZ; and
3. Mr. Laurent GODINEAU.

As of the date of these Listing Particulars, Global Interlink is managed by a board of directors composed of four (4) members being:

1. Jean-Michel HEGESIPPE;
2. Max AARON;
3. Altice Caribbean represented by Jérémie BONNIN; and
4. Altice Bahamas represented by Jérémie BONNIN.

As of the date of these Listing Particulars, ODO is managed by a board of directors composed of five (5) members being:

1. Jean-Michel HEGESIPPE;
2. Erbest RALLO;
3. Max AARON;
4. Altice Caribbean represented by Jérémie BONNIN; and
5. Altice Bahamas represented by Jérémie BONNIN.

As of the date of these Listing Particulars, Tricom is managed by a board of directors composed of five (5) members being:

1. Jean-Michel HEGESIPPE;
2. Marc ROCHER;
3. Max AARON;
4. Representative from Altice Caribbean; and
5. Representative from Altice Bahamas.

As of the date of these Listing Particulars, Winreason is managed by a board of directors composed of four (4) members being:

1. Mr. Dexter GOEI (chairman);

2. Mr. Armando PEREIRA;
3. Mr. Jeremie Jean BONNIN;
4. Mr. François Jean MARC-ANTOINE VAUTHIER.

As of the date of these Listing Particulars, ONI S.G.P.S is managed by a board of directors composed of six (6) members being:

1. Mr. Armando PEREIRA (chairman);
2. Mr. Dexter GOEI;
3. Mr. Pedro Miguel FERREIRA PINTO REI;
4. Mr. Jeremie Jean BONNIN;
5. Mr. João ZUQUETE DUTSCHMANN DE JESUS DA SILVA; and
6. Mr. Alexandre Filipe TEIXEIRA DA FONSECA.

As of the date of these Listing Particulars, Onitelecom is managed by a board of directors composed of seven (7) members being:

1. Mr. Armando PEREIRA (chairman);
2. Mr. Dexter GOEI;
3. Mr. Pedro Miguel FERREIRA PINTO REI;
4. Mr. Jeremie Jean BONNIN;
5. Mr. João ZUQUETE DUTSCHMANN DE JESUS DA SILVA;
6. Mr. Alexandre Filipe TEIXEIRA DA FONSECA; and
7. Mr. François Jean MARC-ANTOINE VAUTHIER.

As of the date of these Listing Particulars, Knewon is managed by a board of directors composed of three (3) members being:

1. Mr. Pedro MIGUEL FERREIRA PINTO REI;
2. Mr. João ZÚQUETE DUTSCHMANN DE JESUS DA SILVA; and
3. Mr. Alexandre FILIPE TEIXEIRA DA FONSECA.

As of the date of these Listing Particulars, Green is managed by the board of directors composed of (2) members:

1. Mr. Franz Grüter, chairman; and
2. Mr. Jérémie BONNIN, member.

As of the date of these Listing Particulars, PT Portugal is managed by a board of directors composed of eight (8) members being:

1. Mr. Armando RODRIGUES CABRAL DE ALMEIDA (chairman);
2. Mr. Marco NORCI SCHROEDER (vice-chairman);
3. Mr. Pedro Humberto MONTEIRO DURÃO LEITÃO;

4. Mr. Nuno José PORTEIRO CETRA;
5. Mr. Eduardo Felipe MICHALSKI;
6. Mr. Flávio Nicolay GUIMARÃES;
7. Mr. Carlos António ALVES DUARTE; and
8. Mr. Manuel Francisco ROSA DA SILVA.

As of the date of these Listing Particulars, PT OpCo is managed by a board of directors composed of eight (8) members being:

1. Mr. Armando RODRIGUES CABRAL DE ALMEIDA (chairman);
2. Mr. Marco NORCI SCHROEDER;
3. Mr. Pedro Humberto MONTEIRO DURÃO LEITÃO;
4. Mr. Nuno José PORTEIRO CETRA;
5. Mr. Eduardo Felipe MICHALSKI;
6. Mr. Flávio Nicolay GUIMARÃES;
7. Mr. Carlos António ALVES DUARTE; and
8. Mr. Manuel Francisco ROSA DA SILVA.

Green is managed by a board of directors composed of two (2) members being:

1. Mr. Franz GRÜTER (chairman); and
2. Mr. Jérémie BONNIN.

Business Year

The business year for each Issuer begins on the first day of January and ends on the last day of December of each year, except for the first business year which commences on August 17, 2012, and ends on December 31, 2012.

The business year for Cool Holding begins on the first day of January and ends on the last day of December of each year.

The business year for SPV1 begins on the first day of January and ends on the last day of December of each year, except for the first business year which commenced on March 22, 2012, being the date of incorporation of SPV1 and ends on December 31, 2012.

The business year for Altice Holdings begins on the first day of January and ends on the last day of December of each year, except for the first business year which commences on January 31, 2013, being the date of incorporation of Altice Holdings and ends on December 31, 2013.

The business year for Altice Portugal begins on the first day of January and ends on the last day of December of each year.

The business year for Cabovisão begins on the first day of January and ends on the last day of December of each year. Until August 31, 2012, the business year for Cabovisão began on the first day of September and ended on the last day of August of each year.

The business year for Altice International begins on the first day of January and ends on the last day of December of each year.

The business year for Altice West Europe begins on the first day of January and ends on the last day of December of each year, except for the first business year which commences on June 5, 2013, being the date of incorporation of Altice West Europe and ends on December 31, 2013.

The business year for Altice Caribbean begins on the first day of January and ends on the last day of December of each year, except for the first business year which commences on October 4, 2012, being the date of incorporation of Altice Caribbean and ends on December 31, 2012.

The business year for Altice Bahamas begins on the first day of January and ends on the last day of December of each year, except for the first business year which commences on October 14, 2013, being the date of incorporation of Altice Bahamas and ends on December 31, 2013.

The business year for Tricom S.A. begins on the first day of January and ends on the last day of December of each year.

The business year for Global Interlink Ltd. begins on the first day of January and ends on the last day of December of each year.

The business year for ODO begins on the first day of January and ends on the last day of December of each year.

The business year for ONI S.G.P.S begins on the first day of January and ends on the last day of December of each year.

The business year for Onitelecom begins on the first day of January and ends on the last day of December of each year.

The business year for Knewon begins on the first day of January and ends on the last day of December of each year.

The business year for Green begins on the first day of January and ends on the last day of December of each year.

The business year for PT Portugal begins on the first day of January and ends on the last day of December of each year.

The business year for PTC begins on the first day of January and ends on the last day of December of each year.

The business year for MEO, S.A. begins on the first day of January and ends on the last day of December of each year.

The business year for Green begins on the first day of January and ends on the last day of December of each year.

Financial statements

The consolidated financial statements of Altice International and the Issuers will be published on an annual basis. These statements will be audited by Altice International's and the Issuers' auditors.

Auditors

The independent auditor (*réviseur d'entreprises agréé*) of the Issuers and Altice International S.à r.l. is Deloitte Audit S.à r.l., a private limited liability company (*société à responsabilité limitée*), having its registered office at 560, rue de Neudorf, L-2220 Luxembourg registered with the Luxembourg Trade and Companies Register under number B0067895 which is a member of the *Institut des Réviseurs d'Entreprises*.

The independent auditor of Orange Dominicana, S.A. was Deloitte & Associés prior to its acquisition by us.

The independent auditor of Altice Portugal until December 31, 2013 was Baker Tilly, PG & Associados, SROC, S.A.

The independent auditor of Cabovisão until December 31, 2013 was Baker Tilly, PG & Associados, SROC, S.A.

The independent auditor of ONI S.G.P.S is Deloitte & Associados, SROC S.A.

The independent auditor of Knewon is Deloitte & Associados, SROC S.A.

The independent auditor of Onitelecom is Deloitte & Associados, SROC S.A.

The independent auditor of Winreason is Deloitte & Associados, SROC S.A.

The independent auditor of PT Portugal is Ascensão, Gomes, Cruz & Associados—Sociedade de Revisores Oficiais de Contas, Lda.

The independent auditor of Green is KPMG AG (CHE-253.502.577), Lucerne, Switzerland.

The independent auditor of PTC (renamed PT OpCo after the merger) is KPMG & Associados—Sociedade de Revisores Oficiais de Contas S.A.

The independent auditor of MEO, S.A. until the merger was Ascensão, Gomes, Cruz & Associados—Sociedade de Revisores Oficiais de Contas, Lda.

The independent auditor of Green was KPMG AG, Lucerne, Switzerland.

The independent auditors of Tricom S.A. were KPMG Central America, S.A.

The independent auditors of Global Interlinks Ltd. were KPMG Central America, S.A.

Litigation

Other than as disclosed in these Listing Particulars, there are no, and have not been any, governmental, legal or arbitration proceedings against or affecting the Issuers or the Guarantors, nor are the Issuers aware of any pending or threatened proceedings of such kind, which may have or have had a significant effect on the financial position of the Issuers.

Offering Memorandum

Except as disclosed in these Listing Particulars:

- there has been no material adverse change in the consolidated financial position of the Issuers or the Guarantors since September 30, 2014; and
- none of the Issuers or any of the Guarantors is or has been involved in any governmental, legal or arbitration proceedings (including any such proceedings which are pending or threatened of which the Issuers or the Guarantor are aware) since the dates of their incorporation, which may have, or have had in the recent past, significant effects on the Issuers' or the Guarantors' financial position or profitability.

The Issuers accept responsibility for the information contained in these Listing Particulars. The information contained in these Listing Particulars are in accordance with the facts and does not omit anything likely to affect the import of such information.

The language of these Listing Particulars are English. Certain legislative references and technical terms have been cited in their original language in order that the correct technical meaning may be ascribed to them under applicable laws.

The Trustee

The New Notes provide for the Trustee to take action on behalf of the holders of the New Notes in certain circumstances, but only if the Trustee is indemnified and/or secured to its satisfaction. It may not be possible for the Trustee to take certain actions in relation to the New Notes and accordingly in such circumstances, the Trustee will be unable to take action, notwithstanding the provision of an indemnity or security to it, and it will be for the holders of the New Notes to take action directly. If the Trustee resigns or is removed, the Issuers will appoint a successor.

GLOSSARY

Term	Definition
“3G”	The third generation of mobile communications standards, referred to in the industry as IMT-2000, capable of data speeds exceeding the 14.4 Kbps of GSM technology.
“4G”	The fourth generation of mobile communications standards, referred to the industry as IMT-Advanced with a nominal data rate of 100 Mbit/s while the client physically moves at high speeds relative to the station, and 1 Gbit/s while client and station are in relatively fixed positions. Expected to provide a comprehensive and secure all-IP based mobile broadband solution to laptop computer wireless modems, smartphones, and other mobile devices. Facilities such as ultra-broadband internet access, IP telephony, gaming services, and streamed multimedia may be provided to users, which when fully implemented is expected to allow for higher data speeds than achievable with 3G and additional network features and capabilities.
“ADSL”	Asymmetrical DSL; an internet access technology that allows voice and high-speed data to be sent simultaneously over local copper telephone line.
“ARPU”	Average Revenue Per User; ARPU is an average monthly measure that we use to evaluate how effectively we are realizing revenues from subscribers. ARPU is calculated by dividing the revenue (for the services provided, in each case including the proportional allocation of the bundling discount) for the respective period by the average number of RGUs for that period and further by the number of months in the period. The average number of RGUs is calculated as the number of RGUs on the first day in the respective period plus the number of RGUs on the last day of the respective period, divided by two.
“bandwidth”	The width of a communications channel; in other words, the difference between the highest and lowest frequencies available for network signals. Bandwidth also refers to the capacity to move information.
“broadband”	Any circuit that can transfer data significantly faster than a dial-up phone line.
“churn”	The number of RGUs for a given service disconnected (either at the customer’s request or due to termination of the subscription by us) during the period divided by the number of average RGUs for such service for such period; statistics do not include customers excluding transfers between our services (other than a transfer between our cable services and our mobile services).
“CPE”	Customer premise equipment, which typically comprises a modem or set-top box and associated cabling and other fittings such as an NIU in order to deliver service to a subscriber.
“DSL”	Digital Subscriber Line; DSL is a technology that provides high-speed internet access over traditional telephone lines.
“DTT”	Digital terrestrial television.
“FTTx”	Fiber optic infrastructure.
“FTTH”	Fiber-to-the-home network.
“HD”	High definition.
“HFC”	Hybrid fiber coaxial.
“HSPA”	High Speed Packet Access, a type of UMTS3G network that supports both mobile communications technology that provides enhanced download and upload speeds.
“IMS”	IP Multimedia Subsystem.
“Internet”	A collection of interconnected networks spanning the entire world, including university, corporate, government and research networks. These networks all use the IP (Internet Protocol) communications protocol.
“IP”	Internet Protocol.
“IPTV”	Internet Protocol television.
“IRU”	Indefeasible Right of Use, the effective temporary ownership of a portion of the capacity of an international cable. IRUs are specified in terms of a certain number of channels of a given bandwidth. IRU is granted by the company or consortium of companies that built the (usually optical fiber) cable.
“ISP”	Internet Service Provider.
“IT”	Information technology, a general term referring to the use of various software and hardware components when used in a business.
“local loop”	The network element used to connect a subscriber to the nearest switch or concentrator, commonly referred to as the “last mile” because it is the part of the network that is connected directly to the subscriber; alternatively the HFC access network.
“LTE”	Long term evolution technology being a standard in mobile network technology.
“M2M”	Machine-to-machine.
“MHz”	Megahertz; a unit of frequency equal to one million Hertz.
“Mbps”	Megabits per second; each megabit is one million bits.
“Moody’s”	Moody’s Investors Services, Inc.
“multiple-play”	The bundling of different telecommunications services, e.g. digital cable television, broadband

	internet and fixed telephony services, by one provider.
“MVNO”	Mobile virtual network operator. Refers to a company that provides mobile services but does not have its own licensed frequency allocation of radio spectrum, nor necessarily all of the infrastructure required to provide mobile telephony services.
“network”	An interconnected collection of components which would, in a telecommunications network, consist of switches connected to each other and to customer equipment by real or virtual links. Transmission links may be based on fiber optic or metallic cable or point to point radio connections.
“PacketCable™”	A CableLabs-led initiative to develop interoperable interface specifications for delivering advanced, real-time multimedia services over two-way cable plant. PacketCable™ networks use IP technology to enable a wide range of multimedia services, such as IP telephony, multimedia conferencing, interactive gaming and general multimedia applications.
“PSTN”	Public switched telephony network.
“PVR”	Personal video recording.
“quad-play”	Triple-play with the addition of mobile service.
“RGU”	Revenue Generating Unit. RGUs relate to sources of revenue, which may not always be the same as customer relationships. For example, one person may subscribe for two different services, thereby accounting for only one subscriber, but two RGUs. RGUs for pay television and broadband internet infrastructure access are counted on a per source service basis and RGUs for fixed-line telephony are counted on a per line basis. Mobile RGUs is equal to the net number of lines or SIM cards that have been activated on our mobile network.
“S&P”	Standard & Poor’s Investors Ratings Services.
“SOHOs”	Small offices and home offices.
“triple-play”	Where a customer has subscribed to a combination of three products, digital cable television, broadband internet and fixed telephony services, from us.
“UMTS”	Universal Mobile Telecommunications Service, a 3G mobile networking standard commonly used to upgrade GSM networks to 3G standards.
“U.S. Docsis 3.0”	Data over cable service interface specification, a technology that enables the addition of high-speed data transfer over an existing cable television system.
“VoD”	Video on demand; a service which provides subscribers with enhanced playback functionality and gives subscribers access to a broad array of on demand programming, including movies, live events, local drama, music videos, children programming and adult programming.
“VoIP”	Voice over Internet Protocol; a telephone service via internet, or via TCP/IP protocol, which can be accessed using a computer, a sound card, adequate software and a modem.
“VPN”	Virtual private network, a business service enabling users to obtain remote access to network functionality.
“VDSL”	Very high speed DSL. A high speed variant of ADSL.
“VoN”	Voice over Net, a form of telephony over the internet that is usually a lower quality than VoIP.

INDEX TO FINANCIAL STATEMENTS

ALTICE INTERNATIONAL

	<u>Page</u>
CONDENSED CONSOLIDATED FINANCIAL STATEMENTS FOR THE THREE MONTH AND NINE MONTH PERIODS ENDED SEPTEMBER 30, 2014 AND 2013	F-5
Condensed Consolidated Statements of Income for the three months and nine months ended September 30, 2014	F-7
Condensed Consolidated Statements of Other Comprehensive Income for the three months and nine months ended September 30, 2014	F-8
Condensed Consolidated Statement of Financial Position as of September 30, 2014	F-9
Condensed Consolidated Statements of Changes in Equity for the nine months ended September 30, 2014 and 2013	F-10
Condensed Consolidated Statements of Cash Flows for the nine months ended September 30, 2014 and 2013	F-12
Notes to the Condensed Consolidated Financial Statements	F-13
Review Report of the Réviseur d'entreprises agréé on Condensed Consolidated Financial Statements	F-32
DECEMBER 31, 2013, HISTORICAL CONSOLIDATED FINANCIAL STATEMENTS	F-33
Report of the Réviseur d'entreprises agréé	F-35
Consolidated Statement of Income for the years ended December 31, 2013	F-36
Consolidated Statement of Other Comprehensive Income for the year ended December 31, 2013	F-37
Consolidated Statement of Financial Position as of December 31, 2013	F-38
Consolidated Statement of Changes in Equity for the years ended December 31, 2013	F-39
Consolidated Statement of Cash Flows for the year ended December 31, 2013	F-40
Notes to the Consolidated Financial Statements	F-41
DECEMBER 31, 2012, HISTORICAL CONSOLIDATED FINANCIAL STATEMENTS	F-126
Report of the Réviseur d'entreprises agréé	F-127
Consolidated Statement of Income for the year ended December 31, 2012	F-128
Consolidated Statement of Other Comprehensive Income for the year ended December 31, 2012	F-129
Consolidated Statement of Financial Position as of December 31, 2012	F-130
Consolidated Statement of Changes in Equity for the year ended December 31, 2012	F-131
Consolidated Statement of Cash Flows for the year ended December 31, 2012	F-132
Notes to the Consolidated Financial Statements	F-133

**UNAUDITED ILLUSTRATIVE AGGREGATED SELECTED FINANCIAL INFORMATION OF
ALTICE INTERNATIONAL**

	Page
Auditor Assurance Report	F-205
Unaudited Illustrative Aggregated Selected Financial Information	F-207
Notes to the Unaudited Illustrative Aggregated Selected Financial Information	F-208

ORANGE DOMINICANA, S.A.

	Page
UNAUDITED CONDENSED INTERIM STANDALONE FINANCIAL STATEMENTS FOR THE NINE MONTHS ENDED SEPTEMBER 30, 2013	F-218
Independent Auditors' Review Report	F-219
Unaudited Interim Income Statement for the nine months ended September 30, 2013	F-221
Unaudited Interim Statements of Financial Position as of September 30, 2013	F-222
Unaudited Interim Statements of Cash Flows for the nine months ended September 30, 2013	F-223
Unaudited Consolidated Statements of Changes in Equity for the nine months ended September 30, 2013	F-224
Notes to the Unaudited Condensed Interim Financial Statements	F-225
DECEMBER 31, 2013 AND 2012 STANDALONE FINANCIAL STATEMENTS	F-232
Independent Auditors' Report	F-233
Income Statement for the years ended December 31, 2013 and 2012	F-236
Statement of Financial Position as of December 31, 2013 and 2012	F-237
Statement of Cash Flows for the years ended December 31, 2013 and 2012	F-238
Statements of Changes in Equity for the years ended December 31, 2013 and 2012	F-239
Notes to the Standalone Financial Statements	F-240
DECEMBER 31, 2012 AND 2011 STANDALONE FINANCIAL STATEMENTS	F-258
Independent Auditors' Report	F-259
Income Statement for the years ended December 31, 2012 and 2011	F-261
Statement of Financial Position as of December 31, 2012 and 2011	F-262
Statement of Cash Flows for the years ended December 31, 2012 and 2011	F-263
Statements of Changes in Equity for the years ended December 31, 2012 and 2011	F-264
Notes to the Standalone Financial Statements	F-265

PTC

	<u>Page</u>
CONDENSED FINANCIAL INFORMATION FOR THE NINE MONTHS ENDED SEPTEMBER 30, 2014 AND 2013	F-280
Condensed Balance Sheets for the nine months ended September 30, 2014 and the year ended December 31, 2013	F-281
Condensed Statements of Income for the nine months ended September 30, 2014 and 2013	F-282
Condensed Statements of Changes in Equity for the nine month periods ended September 30, 2014 and 2013	F-283
Condensed Statements of Cash Flows for the nine months ended September 30, 2014 and 2013	F-285
Condensed Notes to the Financial Statements	F-287
DECEMBER 31, 2013 AND 2012 FINANCIAL STATEMENTS	F-308
Auditor's Report on the Financial Statements for the year ended December 31, 2013	F-309
Balance Sheets as of December 31, 2013 and 2012	F-311
Statements of Income for the years ended December 31, 2013 and 2012	F-312
Statements of Changes in Equity for the years ended December 31, 2013 and 2012	F-313
Statements of Cash Flow for the years ended December 31, 2013 and 2012	F-314
Notes to the Financial Statements	F-316
DECEMBER 31, 2012 AND 2011 FINANCIAL STATEMENTS	F-387
Auditor's Report on the Financial Statements for the year ended December 31, 2012	F-388
Balance Sheets as of December 31, 2012 and 2011	F-390
Statements of Income for the years ended December 31, 2012 and 2011	F-391
Statements of Changes in Equity for the years ended December 31, 2011 and 2012	F-392
Statements of Cash Flow for the years ended December 31, 2012 and 2011	F-394
Notes to the Financial Statements	F-396

MEO, S.A.

	<u>Page</u>
CONDENSED FINANCIAL INFORMATION FOR THE NINE MONTHS ENDED SEPTEMBER 30, 2014 AND 2013	F-467
Condensed Balance Sheets for the nine months ended September 30, 2014 and the year ended December 31, 2013	F-468
Condensed Statements of Income for the nine months ended September 30, 2014 and 2013	F-469
Condensed Statements of Changes in Equity for the nine month periods ended September 30, 2014 and 2013	F-470
Condensed Statements of Cash Flows for the nine months ended September 30, 2014 and 2013	F-471
Condensed Notes to the Financial Statements	F-473
DECEMBER 31, 2013 AND 2012 FINANCIAL STATEMENTS	F-486
Auditor's Report on the Financial Statements for the year ended December 31, 2013	F-487
Balance Sheets as of December 31, 2013 and 2012	F-489
Statements of Income for the years ended December 31, 2013 and 2012	F-490

	<u>Page</u>
Statements of Changes in Equity for the years ended December 31, 2013 and 2012	F-491
Statements of Cash Flow for the years ended December 31, 2013 and 2012	F-492
Notes to the Financial Statements	F-494
DECEMBER 31, 2012 AND 2011 FINANCIAL STATEMENTS	F-531
Auditor's Report on the Financial Statements for the year ended December 31, 2012	F-532
Balance Sheets for the years ended December 31, 2012 and 2011	F-534
Statements of Income for the years ended December 31, 2012 and 2011	F-535
Statements of Changes in Equity for the years ended December 31, 2012 and 2011	F-536
Statements of Cash Flow for the years ended December 31, 2012 and 2011	F-537
Notes to the Financial Statements	F-539

Altice International S.à r.l.
(formerly Altice VII S.à r.l.)
(Société à responsabilité limitée)
Condensed consolidated financial statements as of and
for the three and nine month periods ended September 30, 2014



Altice International S.à r.l

Table of contents

Condensed consolidated statement of income	F-7
Condensed consolidated statement of other comprehensive income	F-8
Condensed consolidated statement of financial position	F-9
Condensed consolidated statement of changes in equity	F-10
Condensed consolidated statement of cash flows	F-12
Notes to the condensed consolidated financial statements	F-13
Review report of the Réviseur d'Entreprises Agréé	F-32

Altice International S.à r.l
Condensed consolidated statement of income
For the three and nine months ended September 30, 2014

	Notes	Nine months ended September, 2014	Nine months ended September, 2013 (restated)	Three months ended September 30, 2014	Three months ended September 30, 2013 (restated)
(in millions of euros)					
Revenues		1,372.8	928.4	506.1	355.8
Purchase and subcontracting services		(324.5)	(262.2)	(113.2)	(103.3)
Other operating expenses		(189.3)	(134.6)	(71.3)	(54.3)
Staff costs and employee benefit expenses	11	(110.4)	(101.1)	(37.6)	(35.5)
General and administrative expenses		(36.8)	(24.0)	(10.0)	(6.9)
Other sales and marketing expenses		(84.9)	(29.4)	(33.7)	(11.5)
Operating profit before depreciation, amortization, management fees, restructuring, non-recurring- costs and other expenses		627.0	377.1	240.3	144.3
Depreciation and amortization	2	(397.6)	(278.0)	(145.2)	(100.3)
Management fees		(0.6)	(0.7)	(0.1)	—
Restructuring, non-recurring costs and other (expenses)/income	9	(58.5)	(12.3)	(15.9)	3.5
Operating profit		170.3	86.1	79.2	47.5
Finance income		32.1	36.2	—	—
Finance costs		(334.3)	(184.3)	(132.0)	(102.5)
Loss before income tax expenses		(132.0)	(62.0)	(52.8)	(55.0)
Income tax expenses	12	(27.6)	(27.4)	(26.4)	(14.3)
Loss for the period		(159.6)	(89.4)	(79.3)	(69.2)
<i>Attributable to equity holders of the parent</i>		(156.5)	(83.3)	(77.7)	(68.6)
<i>Attributable to non-controlling interests</i>		(3.2)	(6.0)	(1.6)	(0.6)

The accompanying notes form an integral part of these condensed consolidated financial statements.

Altice International S.à r.l
Condensed consolidated statement of other comprehensive income
For the three and nine months ended September 30, 2014

Notes	Nine months ended September, 2014	Nine months ended September, 2013 (restated)	Three months ended September 30, 2014	Three months ended September 30, 2013 (restated)
	(in millions of euros)			
Loss for the period	(159.6)	(89.4)	(79.3)	(69.2)
Other comprehensive income				
Exchange differences on translation of foreign operations	27.3	0.6	41.1	(0.8)
Net fair value gain on available-for-sale financial assets	(1.3)	0.8	(0.3)	0.8
Other movements	—	2.6	—	2.6
Employee benefits	0.2	0.2	0.4	—
Total comprehensive income for the period	<u>(133.4)</u>	<u>(85.2)</u>	<u>(38.1)</u>	<u>(66.6)</u>
<i>Attributable to equity holders of the parent</i>	<i>(131.2)</i>	<i>(80.1)</i>	<i>(38.1)</i>	<i>(65.9)</i>
<i>Attributable to non-controlling interests</i> .	<i>(2.2)</i>	<i>(5.1)</i>	<i>(0.0)</i>	<i>(0.7)</i>

The accompanying notes form an integral part of these condensed consolidated financial statements.

Altice International S.à r.l
Condensed consolidated statement of financial position
As of September 30, 2014

	Notes	September 30, 2014	December 31, 2013
(in millions of euros)			
ASSETS			
Current assets			
Cash and cash equivalents		141.3	61.3
Restricted cash	4	—	1,242.8
Trade and other receivables		292.9	230.9
Inventories		21.9	11.0
Current tax assets		15.1	14.6
Total current assets		471.1	1,560.6
Non-current assets			
Deferred tax assets		98.7	47.4
Financial assets		48.6	50.6
Trade and other receivables		26.9	22.8
Property, plant & equipment		1,441.7	1,134.2
Intangible assets		665.8	579.6
Goodwill	3	2,050.0	1,100.7
Total non-current assets		4,331.6	2,935.4
Total assets		4,802.7	4,496.0
LIABILITIES AND EQUITY			
Current liabilities			
Borrowings	7	102.2	57.6
Deferred revenue		100.9	55.9
Trade and other payables		535.6	516.6
Other current liabilities	7	63.3	15.9
Provisions		2.4	2.1
Current tax liabilities		81.3	57.1
Total current liabilities		885.7	705.2
Non-current liabilities			
Borrowings	7	3,581.6	3,421.3
Loans from related parties	7	—	99.2
Other financial liabilities	7	185.9	271.6
Deferred revenue		11.3	10.6
Trade and other payables		17.2	29.0
Retirement benefit obligations		8.2	8.2
Provisions		36.6	29.0
Deferred tax liabilities		169.5	183.1
Total non-current liabilities		4,010.3	4,052.0
Equity			
Issued capital	5	309.2	7.4
Additional Paid In Capital	5	318.4	5.4
Other reserves	6	(374.8)	(82.9)
Accumulated losses		(347.1)	(190.6)
Total equity attributable to the shareholders of the parent		(94.2)	(260.7)
Non-controlling interests		1.0	(0.5)
Total equity		(93.2)	(261.2)
Total liabilities and equity		4,802.7	4,496.0

The accompanying notes form an integral part of these condensed consolidated financial statements.

Altice International S.à r.l.
Condensed consolidated statement of changes in equity
For the nine months ended September 30, 2013

	number of issued shares	Share capital €m	Additional paid in capital €m	Retained losses €m	Other reserves €m	Currency reserve €m	Reserve Available for sale €m
Equity at January 1, 2013	743,011,510	7.4	—	(4.4)	285.8	(6.4)	(2.1)
Transaction with shareholder		—	5.4	—	(205.0)	—	—
Transaction with non-controlling interests		—	—	—	(81.0)	—	—
Change in scope		—	—	—	1.3	—	—
Loss of the period		—	—	(83.3)	—	—	—
Other comprehensive income		—	—	—	2.3	0.0	0.8
Equity at September 30, 2013	743,011,510	<u>7.4</u>	<u>5.4</u>	<u>(87.7)</u>	<u>3.8</u>	<u>(6.4)</u>	<u>(1.3)</u>

The accompanying notes form an integral part of these condensed consolidated financial statements.

Altice International S.à r.l.
Condensed consolidated statement of changes in equity (Continued)
For the nine months ended September 30, 2014

	number of issued shares	Share capital €m	Additional paid in capital €m	Retained losses €m	Other reserves €m	Currency reserve €m	Reserve Available for sale €m
Equity at January 1, 2014	743,011,510	7.4	5.4	(190.6)	(76.6)	(6.7)	(0.4)
Shareholder Contribution	30,182,688,490	301.8	313.0	—	(317.0)	—	—
Change in scope		—		—	(0.1)	—	—
Loss for the period		—	—	(156.5)	—	—	—
Other comprehensive income		—	—	—	—	26.1	(1.3)
Other movement		—	—	—	0.1	—	—
Equity at September 30, 2014	30,925,700,000	<u>309.2</u>	<u>318.4</u>	<u>(347.1)</u>	<u>(393.7)</u>	<u>19.4</u>	<u>(1.7)</u>

The accompanying notes form an integral part of these condensed consolidated financial statements.

Altice International S.à r.l
Condensed consolidated statement of cash flows
for the nine months ended September 30, 2014

	Notes	September 30, 2014	September 30, 2013
(€ in millions)			
Loss for the period		(159.6)	(89.4)
Adjustments for :			
Depreciation and amortization		397.6	278.0
Loss / (Gain) on disposals		1.7	(4.1)
Other non-cash operating gains and losses		8.4	6.5
Net cash provided by operating activities before changes in working capital, finance costs and income tax		248.0	184.9
Finance costs, net		302.2	158.2
Income tax expense recognised in profit and loss		27.6	27.5
Income tax paid		(38.6)	(4.8)
Changes in working capital		(36.6)	(77.0)
Net cash provided by operating activities		502.7	288.8
Payment to acquire tangible and intangible assets		(306.6)	(184.1)
Proceeds from disposal of assets		1.1	1.9
Payment to acquire available for sale financial assets		—	(18.3)
Increase in loans and other non-current financial assets			7.4
Change in restricted cash	4	1,243.7	(0.6)
Transactions with non-controlling interests	2	(8.9)	(105.0)
Net payments on acquisition of subsidiaries	2	(1,270.1)	(203.5)
Net cash used in investing activities		(340.8)	(502.2)
Shareholder contribution		95.3	1.8
Proceeds from debt issuance	8	105.7	1,021.9
Repayment of debt	8	(110.7)	(546.4)
Distribution to holders of hybrid instruments		—	(212.5)
Interest paid		(173.5)	(119.4)
Net cash provided by financing activities		(83.3)	145.4
Effects of exchange rate changes on the balance of cash held in foreign currencies		0.7	—
Net increase in cash and cash equivalents		79.5	(67.9)
Cash and cash equivalents at the beginning of the period		61.3	129.8
Cash and cash equivalents at the end of the period		140.8	61.9
<i>Cash and cash equivalents</i>		141.3	61.9
<i>Bank overdraft</i>		(0.6)	—

The accompanying notes form an integral part of these financial statements

Altice International S.à r.l.
Notes to the condensed consolidated financial statements

Note 1—Nature of the business, basis of preparation and accounting policies

Nature of the business

Altice International S.à r.l. (formerly Altice VII S.à r.l.) (the “Company”) is a private limited liability company (société à responsabilité limitée) incorporated under the laws of the Grand Duchy of Luxembourg on December 15, 2008, and registered under the number B 143.725 in Luxembourg. The Group refers to the Company and its subsidiaries. The Company was initially established as a public limited company (société anonyme) and then converted to a private limited liability company on October 7, 2009.

The registered office of the Company is established at 3, boulevard Royal, L-2449 Luxembourg, and as at September 30, 2014 its sole equity holder is Altice S.A. The ultimate controlling party is considered to be Patrick Drahi.

On January 31, 2014, Next LP contributed all its economic interests in Altice International S.à r.l. to Altice S.A. (“Altice”) in exchange for shares in Altice S.A..

Altice is listed on Euronext in Amsterdam. The consolidated financial statements of Altice are available at the registered address of Altice: 3, boulevard Royal, L 2449 Luxembourg and on its website: www.altice.net.

Altice International offers a variety of services over its cable and mobile infrastructure, including, but not limited to, pay television, broadband Internet access, fixed-line telephony and mobile telephony to residential customers, and, to a lesser extent, corporate customers, depending on the country. Available cable-based service offerings depend on the bandwidth capacity of its cable networks and whether they have been upgraded for two-way communications. Most of Altice International’s operating subsidiaries operate Docsis 3.1 enabled networks. Where possible, Altice International Group intends to deploy the same technologies and equipment across its footprints to generate economies of scale and common knowledge. In addition, the Group companies aim at sharing skills and best practices across the various operations of the Group.

Television service offerings include basic and premium programming, and, in most markets, incremental product and service offerings such as enhanced pay-per-view programming, including video-on-demand (“VoD”) and near-video-on-demand (“NVoD”), digital video recorders (“DVR”), high definition (“HD”) television services and, in certain areas, exclusive content, purchased or produced. The Altice International Group tailors its basic and premium channel line-up to each country of operation according to culture, demographics, programming preferences and local regulation. The Altice International Group also offers broadband Internet access services and fixed-line telephony in all its footprints. It also owns and operates mobile infrastructures in certain geographies (French Overseas Territories, Dominican Republic and Israel) and offers mobile services through an MVNO (Mobile Virtual Network Operator) arrangement in Belgium.

Altice International’s operational entities operate in the following geographies listed below. When possible, the Group tries to achieve convergence and integration between existing cable and mobile networks.

- Israel (Cable and mobile)
- Dominican Republic (Cable and mobile)
- French Overseas Territories (Cable and mobile)
- Portugal (Cable)
- Belgium and Luxembourg (Cable and mobile through MVNO)
- Others (mainly cable based operations and datacenter in Switzerland, content companies and holding activities)

Note 1—Nature of the business, basis of preparation and accounting policies (Continued)

Basis of presentation

The condensed consolidated financial statements of the Company as of and for the three and nine months ended September 30, 2014 have been prepared in accordance with International Accounting Standard (“IAS”) No. 34 “Interim Financial Reporting”. They should be read in conjunction with the annual consolidated financial statements and the notes thereto as of and for the year ended December 31, 2013 which have been prepared in accordance with International Financial Reporting Standards as adopted in the European Union (“IFRS”).

Comparative information

The comparative information for the nine and three month periods ended September 30, 2013 has been restated to reflect the impact of the purchase price allocation of the assets of ONI S. G.P.S (“ONI”) acquired on August 8, 2013. As per the provisions of IFRS 3:49, the impact of the recognition of the identifiable tangible and intangible assets of ONI at their fair value was restated for the nine and three month period ended September 30, 2013. The total impact on depreciation and amortisation was €0.4 million (€0.3 million net of deferred tax). The loss for the period was impacted by the same amount.

In addition to the restatement described above, staff costs and employee benefits were reclassified to match the presentation adopted for the three and nine months ended September 30, 2014. Such costs amounted to €57.7million for technical and maintenance and customer service staff and €24.0 million for marketing staff costs and have been reclassified from the lines “other operating expenses” and “other sales and marketing expenses” to “staff costs and employee benefits expenses”.

Accounting policies

The condensed consolidated financial statements have been prepared on an historical cost basis, except for (i) available-for-sale financial assets, (ii) derivative financial instruments which are measured at market value and (iii) inventories which are measured at the lower of net realizable value or cost. The accounting policies used to prepare the condensed consolidated financial statements are similar to those described in Note 2 to the consolidated financial statements as of and for the year ended December 31, 2013.

There were no other significant effects on the condensed consolidated financial statements as a result of the adoption of any of the below mentioned standards or interpretations.

New standards applied for the first time in the current period

For the period ended September 30, 2014, the Group has applied the following amendments to IAS standards, made compulsory for annual periods beginning on or after January 1, 2014.

- Amendments to IAS 39—Novation of Derivatives and Continuation of Hedge Accounting:
Under the revised standard, the novation of a hedging instrument should not be considered as an expiration or termination giving rise to the discontinuation of hedge accounting when a hedging derivative is novated. This amendment has no impact on the condensed consolidated financial statements of the Company.
- Amendments to IAS 36—Recoverable Amount Disclosures:
The overall effect of the amendments is to reduce the circumstances in which the recoverable amount of assets or cash-generating units is required to be disclosed, clarify the disclosures required, and to introduce an explicit requirement to disclose the discount rate used in determining impairment (or reversals) where recoverable amount (based on fair value less costs of disposal) is determined using a present value technique.

This amendment has no impact on the condensed consolidated financial statements of the Company.

Notes to the condensed consolidated financial statements (Continued)

Note 1—Nature of the business, basis of preparation and accounting policies (Continued)

- IFRIC 21—Levies

IFRIC 21 provides guidance on when to recognise a liability for a levy imposed by a government, both for levies that are accounted for in accordance with IAS 37 Provisions, Contingent Liabilities and Contingent Assets and those where the timing and amount of the levy is certain. Management has assessed that the implementation of IFRIC 21 has no significant impact on the condensed consolidated financial statements of the Company for the nine month period ended September 30, 2014.

- Draft position paper on IAS 19 on the subject of the existence of a deep market for corporate bonds in Israel

On September 1, 2014, the Securities Authority of Israel published a draft position paper (the “draft position”) in accordance with which a deep market exists in Israel for high quality Shekel denoted corporate bonds. In accordance with the said draft position, commitments in respect of post-employment employee benefits as well as commitments in respect of other long-term benefits are to be discounted using a discount rate that is derived from corporate bonds, instead of discounting them at a discount rate that is derived from government bonds, which will lead to the increasing of the discount rate and the reduction of the commitments. In accordance with the draft position, this change is to be reflected by way of a change in an estimate.

The Company is examining the possible impact of the standard on the annual financial statements for the year 2014.

Significant accounting judgments and estimates used in the preparation of the financial statements

Judgments

In the process of applying the significant accounting policies, the Group has exercised its judgment and has taken into account matters which have the most significant impact on the amounts that have been recognized in the condensed consolidated financial statements.

Estimates and assumptions

The preparation of the condensed consolidated financial statements requires the Group to make estimates and assumptions that have an effect on the application of the accounting policies and on the reported amounts of assets, liabilities, revenues and expenses. These estimates and underlying assumptions are reviewed regularly. Changes in accounting estimates are reported in the period in which the estimate changes.

Impairment of goodwill

Determining whether goodwill is impaired requires an estimation of the value in use of the cash-generating units (herein after referred to as “CGU” or “CGUs”) to which goodwill has been allocated. The value in use calculation requires the Board of Managers to estimate the future cash flows expected to arise from the CGUs and a suitable discount rate in order to calculate present value. Where the actual future cash flows are less than expected, a material impairment loss may arise.

Legal claims

In estimating the likelihood of outcome of legal claims filed against the Group and its investees, the Group companies rely on the opinion of their legal counsel. These estimates are based on the legal counsel’s best professional judgment, taking into account the stage of proceedings and historical legal precedents in respect of the different issues. Since the outcome of the claims will be determined in courts, the results could differ significantly from these estimates.

Note 1—Nature of the business, basis of preparation and accounting policies (Continued)

Post-employment benefits

The liability in respect of post-employment defined benefit plans is determined using actuarial valuations. The actuarial valuation involves making assumptions about, among others, discount rates, expected rates of return on assets, future salary increases and mortality rates. Due to the long-term nature of these plans, such estimates are subject to uncertainty.

Deferred tax assets

Deferred tax assets relate primarily to tax losses carried forward and to deductible temporary differences between reported amounts and the tax basis of assets and liabilities. The assets relating to the tax losses carried forward are recognized if it is probable that the Group will generate future taxable profits against which these tax losses can be offset. Evaluation of the Group's capacity to utilize tax losses carried forward relies on significant judgment. The Group analyses past events, and the positive and negative elements of certain economic factors that may affect its business in the foreseeable future to determine the probability of its future utilization of these tax losses carried forward.

Note 2—Main changes in the scope of consolidation

2.1 Dominican Republic

Tricom S.A. and Global Interlinks Limited (“Tricom” and “GLX”, respectively)

On March 12, 2014, the Group, through its indirect subsidiary, Altice Dominican Republic, completed the acquisition of an approximately 97.2% stake in Tricom., a cable and mobile operator with a 4G license based in the Dominican Republic, and of GLX, the owner of a submarine cable, which it uses to sell data and voice transmission services to other operators based in the region (including Tricom). Through this acquisition, the Group expects to consolidate and expand its cable operations in the Caribbean Islands and explore synergies through the vertical integration of its operations in the region and synergies with other operations in the region.

Since March 12, 2014, Tricom and GLX contributed €82.0 million in revenue and €14.1 million in operating profit to the Group's result for the nine months ended September 30, 2014.

The following summarises certain of the major classes of consideration transferred and the provisionally determined amounts of identifiable assets and liabilities assumed at the acquisition date:

Total consideration paid to the vendors for the shares of the acquired entities amounted to €299.2 million on a cash-free, debt-free basis.

The total value of assets transferred in consideration for the values mentioned above amounted to €214.8 million, comprising mainly intangible assets for a net value of €4.4 million, property, plant and equipment for a total value of €133.2 million and trade and other receivables for a total amount of €67.3 million. Total liabilities amounted to €82.7 million, comprising €40.8 million of non-current liabilities and €41.9 million of current liabilities. Additionally, adjustments related to the conversion of the opening balance from US GAAP to IFRS standard led to an increase in fixed assets of €2.8 million, thus increasing the net value of assets transferred to €134.9 million. The residual value of €164.3 million was recognised provisionally as goodwill.

The values of the assets and liabilities assumed have been determined on a provisional basis as being equivalent to the book values in the accounting records of Tricom and GLX. The Company is continuously assessing the fair valuation of the identifiable assets and liabilities assumed and shall complete this exercise within twelve months from the acquisition date.

Altice Hispaniola (“ODO” or “Orange Dominicana S.A.”)

On April 9, 2014, the Group, through its direct subsidiary Altice International S.à r.l., completed the acquisition of a 97.2% stake in ODO, the leading mobile operator in the Dominican Republic. ODO

Note 2—Main changes in the scope of consolidation (Continued)

operates a high end, 4G-enabled mobile network in the Dominican Republic covering up to 86% of the territory of the Dominican Republic.

Through this acquisition, the Group expects to further consolidate and expand its operations in the Caribbean Islands. This transaction complements the acquisition of Tricom and GLX mentioned above and completes the formation of an integrated telecom group in the Dominican Republic.

Since April 9, 2014, ODO contributed €218.6 million to the Group revenue and €62.7 million to the Group operating profit for the nine months ended September 30, 2014.

The following summarises certain of the major classes of consideration transferred and the provisionally determined amounts of identifiable assets and liabilities assumed at the acquisition date:

Total consideration paid to the vendors for the shares of the acquired entity amounted to €1,034.0 million on a cash free, debt free basis.

The total value of assets transferred in consideration for the values mentioned above amounted to €437.9 million, comprising mainly intangible assets for a net value of €34.8 million, property, plant and equipment for a total value of €229.0 million and trade and other receivables for a total amount of €113.5 million. Total liabilities amounted to €103.7 million, comprising €8.7 million of non-current liabilities and €94.1 million of current liabilities.

In addition to the assets transferred and as part of the provisionally purchase price allocation, two additional assets were identified being the capitalisation of subscriber acquisition costs and the intangible asset corresponding to the value of the Orange brand. Subscriber acquisition costs were capitalised as part of the alignment of accounting principles of ODO with Altice Group policies. The net book value of such assets was ascertained to be €2.7 million as at the date of acquisition. The right for the continued use of the Orange brand was valued on a preliminary basis at €19.9 million. This value is subject to revision, following the finalisation of the purchase price allocation for ODO.

As part of the purchase agreement, the vendor agreed to finance the acquisition of a spectrum license to provide 3G services in the Dominican Republic using ODO's existing network. The price of this license was adjusted when calculating the purchase price. The total amount due for the license amounted to €20.8 million (\$ 28.5 million). This investment is recorded as capital investment in the accounts of Orange Dominicana as of September 30, 2014, however, it relates to an investment that was not paid for by the Group.

The values of the assets and liabilities assumed have been determined on a provisional basis as being equivalent to the book values in the accounting records of ODO. The Company is continuously assessing the fair valuation of the identifiable assets and liabilities assumed and shall complete this exercise within twelve months from the acquisition date.

Goodwill has been provisionally recognised as a result of the acquisitions (including Tricom and GLX) as follows:

Total consideration transferred	€1,333.2 million
Fair value of identifiable assets, liabilities and contingent liabilities	€ 491.7 million
Goodwill	€ 841.5 million

2.2 French Overseas Territories (“FOT”)

Mobius S.A.S. (“Mobius”)

On January 15, 2014, the Company, through its subsidiary, Altice Blue Two S.A.S., obtained control over Mobius, a telecommunications operator in the French Overseas Territories (specifically, La Reunion), by acquiring 99.9% of the shares and voting interests in the company. This acquisition enables the Group to further expand and consolidate its footprint in the French Overseas Territories.

Altice International S.à r.l.

Notes to the condensed consolidated financial statements (Continued)

Note 2—Main changes in the scope of consolidation (Continued)

Since January 1, 2014, Mobius contributed €13.2 million to revenue and €1.0 million to the Group operating profit for the nine months ended September 30, 2014.

The following summarises certain of the major classes of consideration transferred and the provisionally determined amounts of identifiable assets and liabilities assumed at the acquisition date:

- Total consideration paid to the vendors for the shares of the acquired entity amounted to €18.8 million on a cash-free, debt-free basis.
- The total value of assets transferred in consideration for the values mentioned above amounted to €14.8 million, comprising mainly intangible assets for a net value of €7.1 million, property, plant and equipment for a total value of €1.2 million, financial assets for a total value of €3.2 million and trade and other receivables for a total amount of €2.9 million. Total liabilities amounted to €13.8 million, comprising €5.1 million of non-current liabilities and €8.7 million of current liabilities. The residual value of €17.8 million was recognised provisionally as goodwill.

The values of the assets and liabilities assumed have been determined on a provisional basis as being equivalent to the book values in the accounting records of Mobius. The Company is continuously assessing the fair valuation of the identifiable assets and liabilities assumed and shall complete this exercise within twelve months from the acquisition date.

Goodwill has been recognised as a result of the acquisition as follows:

Total consideration transferred	€18.8 million
Fair value of identifiable assets and liabilities	€ 1.0 million
Goodwill	€17.8 million

Profit and loss before acquisition by the group

The profit and loss of those new subsidiaries not consolidated from January 1, 2014, for the period from January 1, 2014 to the date of their entry into the Group's accounts is given below:

	<u>Tricom</u>	<u>ODO</u>
	(in € millions)	
Revenues	38.7	108.8
Purchases and subcontracting services	(11.1)	(27.4)
Gross Profit	27.6	81.4
Other operating expenses	(4.2)	(10.3)
General and administrative expenses	(1.7)	(6.7)
Other sales and marketing expenses	(2.2)	(19.0)
Staff costs and employee benefits	(5.3)	—
Operating profit before depreciation and amortization	14.1	45.5
Depreciation and amortization	(5.1)	(15.3)
Management fees	(0.8)	(2.9)
Operating profit	8.2	27.4
Profit for the period	5.4	19.3

2.3 Acquisition of non-controlling interests—Altice Blue Two S.A.S. (“ABT”)

On June 27, 2014, Altice S.A., the direct shareholder of the Company, transferred its stake in Altice Blue Two to Altice Caribbean, the direct shareholder of Altice Blue Two. Following this transaction, Altice Caribbean now holds a 99.7% stake in Altice Blue Two.

Note 3—Goodwill

Goodwill is reviewed for impairment at each Cash Generating Unit (“CGU”) level, annually and whenever changes in circumstances indicate that its carrying amount may not be recoverable. For 2013, goodwill was tested for impairment at the CGU level as of December 31. CGUs were at the time determined to coincide with subsidiaries of the Company.

For the nine months period ended September 30, 2014, the Management has decided to reorganize the way the cash generating units (CGUs) are presented, in order to be consistent with the structuring process that the Group has undergone in its different jurisdictions and that is aligning to the way management operates the different segments of the Group (see note 8). To this end, CGUs now reflect specific geographic areas in which one or several legal structures can be found (eg. Cabovisao and ONI form Portugal, Tricom/GLX and ODO, Dominican Republic). Historically, each CGU was presented as a standalone legal entity, as the Group had only one operating entity per geography. The rapid expansion of the Group and the push to achieve synergies between fixed, cable and mobile networks in its relevant operating geographies prompted Board of Managers to acquire new structures in the regions where it was already operating. Management believes that combining individual acquired entities is the most economic method of capturing synergies between new, complementary businesses in each operational region. This is underlined by the technical synergies between the different networks, the fact that the teams are now integrated and as a result of the bundle offers to the client. An illustrative example is the integration of support functions in the French Overseas Territories (between OMT and Le Cable, together “FOT”), in Portugal with Cabovisao and ONI and the on-going restructuring of the Dominican entities, in order to have a single, functional support team in the finance, marketing and technical departments. In addition to this, contracts with service providers are negotiated by one entity for the relevant geographies thus providing better purchasing power for the CGU as a whole. Moreover, internal tracking and monthly financial and operation reviews performed by Management are based on specific geographies and not on individual companies, thus the new presentation provides an accurate vision of how Management tracks and runs its businesses internally.

The recoverable amounts of the CGUs are determined based on their value in use. The Company determined value in use for the purpose of its impairment testing and, accordingly, did not determine the fair value of the CGUs as the carrying value of the CGUs was lower than their value in use. The key assumptions for the value in use calculations are primarily the pre-tax discount rates, the EBIT margin, the terminal growth rate and the churn rate during the period.

The value in use of the CGUs was determined by estimating cash flows for a period of five years, giving due consideration to the nature of the industry in which each CGU operates. Assumptions for churn rates and EBIT margin were based on historical experience and expectations of future changes in the market. Cash flow forecasts were derived from the most recent financial plans approved by management.

The Board of Managers has determined that there have not been any changes in circumstances indicating that the carrying amount of goodwill may not be recoverable and therefore no updated

Altice International S.à r.l.

Notes to the condensed consolidated financial statements (Continued)

Note 3—Goodwill (Continued)

impairment model analysis has been carried out nor any impairment recorded for the period ended September 30, 2014.

	December 31, 2013	Business combinations	Variations	Impairment losses	Changes in foreign currency translation	Disposals	September 30, 2014
	(in millions of euros)						
Dominican Republic .	—	841.5		—	75.9	—	917.4
Israel	620.3	—		—	17.1	—	637.4
FOT	293.9	17.8		—	—	—	311.7
Belux	295.4	—		—	—	—	295.4
Switzerland	17.8	0.5		—	—	—	18.3
Portugal	1.3	—		—	—	—	1.3
Total Gross Value . .	<u>1,228.7</u>	<u>859.8</u>	—	—	<u>93.0</u>	—	<u>2,181.5</u>
Dominican Republic .	—	—	—	—	—	—	—
Israel	(128.0)	—	—	—	(3.5)	—	(131.5)
FOT	—	—	—	—	—	—	—
Belux	—	—	—	—	—	—	—
Switzerland	—	—	—	—	—	—	—
Portugal	—	—	—	—	—	—	—
Total Cumulative impairment	<u>(128.0)</u>	—	—	—	<u>(3.5)</u>	—	<u>(131.5)</u>
Dominican Republic .	—	841.5	—	—	75.9	—	917.4
Israel	492.3	—	—	—	13.6	—	505.9
FOT	293.9	17.8	—	—	—	—	311.7
Belux	295.4	—	—	—	—	—	295.4
Switzerland	17.8	0.5	—	—	—	—	18.3
Portugal	1.3	—	—	—	—	—	1.3
Total Net book value	<u>1,100.7</u>	<u>859.8</u>	—	—	<u>89.5</u>	—	<u>2,050.0</u>

Note 4—Restricted cash

The restricted cash presented on the statement of financial position as of December 31, 2013 has been fully used to consummate the Tricom/GLX and ODO transactions. See note 2 for more details.

Note 5—Issued capital and share premium

5.1 Issued capital

As of September 30, 2014, total issued capital of the Company amounted to € 309.2 million, and was composed of 30,925,700,000 outstanding ordinary shares, with a nominal value of € 0.01 each.

As part of its initial public offering, the Company's sole partner, Altice S.A. performed a restructuring of the equity structure of the Company.

Altice International S.à r.l.

Notes to the condensed consolidated financial statements (Continued)

Note 5—Issued capital and share premium (Continued)

As part of this restructuring, all convertible preferred equity certificates (CPECs) and other shareholder debts held by Altice S.A. were contributed in exchange for shares in the Company. Details are given below:

	September 30, 2014	December 31, 2013
	(in € millions)	
Opening balance	7.4	7.4
Conversion of convertible instruments (“CPECs”)	290.5	—
Conversion of Valemi Corp S.A. vendor note	0.7	—
Capital increase relating to Tricom S.A. closing	1.1	—
Capital increase relating to Orange Dominicana S.A. closing	8.6	—
Capital increase relating to transaction with non-controlling interests	0.9	—
Closing balance	309.2	7.4

5.2 Additional Paid in Capital

Total additional paid in capital of the Group increased by € 309.4 million to reach € 318.4 million as of September 30, 2014 (€ 5.4 million as of December 31, 2013). This variation is explained below:

	September 30, 2014	December 31, 2013
	(in € millions)	
Opening balance	5.4	—
Share premium issuance	—	5.4
Conversion of shareholder debts	137.3	—
Conversion of Altice IV S.A. vendor note	13.9	—
Conversion of Valemi Corp S.A. vendor note	6.1	—
Share premium relating to Tricom S.A. closing	10.2	—
Share premium relating to the ODO closing	77.8	—
Share premium relating to the ABT contribution	59.7	—
Share premium relating to transaction with non-controlling interests	8.0	—
Closing balance	318.4	5.4

A restructuring of the shareholder debts held by Next L.P. against Altice International was carried out at the beginning of 2014. As a result of this restructuring, the shareholder debts were contributed by Next L.P. to Altice S.A. in exchange for newly issued shares of Altice S.A.. All outstanding Yield Free Preferred Equity Certificates (€ 38.3 million), Asset Linked Preferred Equity Certificates (including accrued interests, € 95.0 million) and interest free loans (€ 3.9 million) were then contributed to the Company at their nominal value.

Altice IV S.A. and Valemi Corp S.A., the holders of vendor notes against the Company (pertaining to the acquisition of Ma Chaine Sports S.A. and SportV S.A. in Q4 2013), contributed these assets to Altice S.A. at their nominal values of € 13.9 million and € 6.1 million respectively, in exchange for new shares issued by Altice S.A., who further contributed these instruments to Altice International, in exchange for new shares issued by the Company.

On March 12, 2014 and April 9, 2014, Altice S.A. subscribed to a capital issuance of the Company for amounts that included €10.2 million and €77.8 million of share premium, related to the closing of the Tricom S.A. and Orange Dominicana acquisitions respectively.

As mentioned in note 2.3, on June 27, 2014, Altice S.A. contributed its stake in Altice Blue Two to Altice Caribbean, through a series of cascading capital increases, starting with Altice International, of which €59.7 million was recognised as share premium.

Altice International S.à r.l.

Notes to the condensed consolidated financial statements (Continued)

Note 5—Issued capital and share premium (Continued)

On July 1, 2014, the Group acquired non-controlling interests in Green Ch and Green Data Center. These businesses are located in Switzerland and were already under the control of the Group as at acquisition date. The transaction have been financed by a cash contribution from the shareholder amounting to € 8.9 million corresponding to a capital increase of 0.9 million (see note 5.1) and € 8.0 million allocated to share premium.

Note 6—Reserves

	September 30, 2014	December 31, 2013
	(in millions of euros)	
CPEC reserve (see note 5.1)	—	290.5
Discounting reserve	—	25.3
Employee benefits reserve	1.0	0.8
Change of foreign exchange translation	19.4	(6.7)
Impact of changes in ownership interests	(71.7)	(71.5)
Available for sale reserve	(1.7)	(0.4)
Other reserves	(322.0)	(320.9)
Group reserves	(374.9)	(82.9)

Note 7—Borrowings and other financial liabilities

Total financial liabilities are broken down as follows:

	September 30, 2014	December 31, 2013
	(in millions of euros)	
Borrowings	3,581.6	3,421.3
Loans from related parties	—	99.2
Finance leases	11.2	23.4
Other financial liabilities	48.3	105.9
Financial instruments	126.4	142.3
Non-current liabilities	3,767.5	3,792.1
Borrowings:	102.2	57.4
— <i>Loans from financial institutions and bonds</i>	39.4	26.8
— <i>Bank overdraft</i>	0.6	—
— <i>Accrued interest</i>	62.3	30.8
Other current liabilities:	63.3	15.9
— <i>Other financial liabilities</i>	52.6	4.5
— <i>Finance leases</i>	10.6	11.4
Current liabilities	165.5	73.5
Total	<u>3,933.1</u>	<u>3,865.6</u>

7.1 Borrowings

Borrowings are composed of loans from financial institutions and bonds. As at September 30, 2014, the details of the loans from financial institutions and bonds are given in the sections that follow.

Altice International S.à r.l.

Notes to the condensed consolidated financial statements (Continued)

Note 7—Borrowings and other financial liabilities (Continued)

The maturities of borrowings is given below:

	September 30, 2014	< 1 year (in millions of euros)	One year or more	December 31, 2013
Bonds	2,696.3	27.1	2,669.2	2,554.0
Loans from financial institutions	924.7	12.3	912.4	894.1
Total	<u>3,621.0</u>	<u>39.4</u>	<u>3,581.6</u>	<u>3,448.1</u>

7.1.1 Bonds

The Group bonds are split as follows:

Issuer	Fair value in millions of euros September 30, 2014	Coupon	Year of maturity	Carrying amount September 30, 2014	Carrying amount December 31, 2013
—Debentures	289.9	Between 3.9% and 6.9% + Consumer Price Index	2018	261.3	280.1
—Senior Secured Notes USD 460 M	389.3	7.875%	2019	350.8	305.1
—Senior Secured Notes EUR 210M	227.9	8.00%	2019	202.9	201.8
—Senior Secured Notes EUR 300M	316.5	6.5%	2022	290.9	292.8
—Senior Secured Notes USD 900M	726.9	6.5%	2022	698.4	637.3
—Senior Notes USD 425M . .	378.6	9.875%	2020	337.4	309.1
—Senior Notes EUR 250M . .	282.8	9.00%	2023	245.6	245.3
—Senior Notes USD 400M . .	335.7	8.125%	2024	309.0	282.5
Total value of bonds	2,947.6			2,696.3	2,554.0
<i>Of which due within one year</i>	<i>27.1</i>			<i>27.1</i>	<i>26.8</i>
<i>Of which due after one year .</i>	<i>2,920.5</i>			<i>2,669.2</i>	<i>2,527.2</i>

7.1.2 Borrowings from financial institutions

- In the period ended September 30, 2014, €17.5 million was repaid to lenders of the € 60.0 million RCF facility, which was drawn in January 2014 to finance the acquisition of Mobius S.A.S.. The remaining portion of €3.5 million was repaid in July 2014.
- New debt was issued by Green Datacenter for a total amount of € 8.2 million in order to finance the construction of additional datacentre capacities to support its commercial development.
- The Group repaid a total of \$ 7.8 million (€ 5.8 million) linked to the amortization of the \$ 1,034 million term loan issued by Altice Financing.
- The overall increase is linked to the revaluation of the debt labelled in foreign currency at the closing rate as of September 30, 2014

7.2 Loans from related parties

As part of the initial public offering of Altice S.A., a restructuring of loans from related parties was carried out, following which all existing related party loans held by Next L.P. and issued by Altice International S.à r.l. were contributed to Altice S.A. by Next L.P., in exchange for shares of Altice S.A..

Note 7—Borrowings and other financial liabilities (Continued)

As per the accounting standards, such instruments, being interest free in nature, had been recorded at their fair value in the consolidated financial statements. In 2014, these instruments were contributed at their nominal value and converted into share capital and share premium of the Company thus, previous discounting reserves recorded in the accounts of Altice International were reversed, thus leading to an adjustment of € (1.1) million to the Group's consolidated reserves. See note 6.

As of September 30, 2014, no loans from related parties were outstanding.

7.3 Other financial liabilities

Variation in other financial liabilities is explained mainly by the cancellation of Altice Blue Two put. The minority shareholders of Altice Blue Two exchanged their shares in Altice Blue Two against common shares in Altice S.A. As a result of this exchange, the put agreement in place at Altice Blue Two was cancelled (considered to be unexercised), leading to the reversal of a debt amounting to € 53.2 million.

In addition to the transaction described above, the company received a short term loan from its sole partner, Altice S.A. for an amount of €46 million, which explains the increase this caption for the nine month period ended September 30, 2014.

7.4 Classification and fair value of financial assets and liabilities

The Group has financial instruments with fair values that are determined by reference to significant unobservable inputs i.e. those that would be classified as level 3 in the fair value hierarchy. There have been no transfers of assets or liabilities between levels of the fair value hierarchy. There are no non-recurring fair value measurements.

The financial instruments that are presented in the condensed consolidated statement of financial position in accordance with their fair value are classified in accordance with groups that have similar characteristics, into hierarchical levels for fair values, as aforesaid, which are determined in accordance with the source of the input that was used for determining the fair value:

- Level 1—Quoted prices (without adjustments) in an active market for identical assets and liabilities.
- Level 2—Inputs other than quoted prices that are included in level 1, which can be observed directly or indirectly.
- Level 3—Inputs that are not based on observable market data (an evaluation technique that does not use observable market data).

As of September 30, 2014, the classification of financial instruments is summarized below:

For the nine month period ended September 30, 2014	Recorded Value in Condensed Consolidated Statement of Financial Position	Level 1 Quoted Prices in active markets for identical assets/ liabilities	Level 2 Significant other observable inputs	Level 3 Inputs that are not based on observable market data
(€ in millions)				
Recurring Fair Value Measurements				
<i>Financial assets</i>				
—Wananchi Group	31.9	—	—	31.9
—Partner Communications Co.	7.1	7.1	—	—
—Other financial assets at FVTPL	0.2	—	—	0.2
<i>Financial liabilities</i>				
—Other financial liabilities at FVTPL (derivative instruments)	126.4	—	124.4	2.0

Altice International S.à r.l.

Notes to the condensed consolidated financial statements (Continued)

Note 7—Borrowings and other financial liabilities (Continued)

<u>For the year ended December 31, 2013</u>	<u>Recorded Value in Condensed Statement of Financial Position</u>	<u>Level 1 Quoted Prices in active markets for identical assets/ liabilities</u>	<u>Level 2 Significant other observable inputs</u>	<u>Level 3 Inputs that are not based on observable market data</u>
			(€ in millions)	
Recurring Fair Value Measurements				
<i>Financial assets</i>				
—Wananchi Group	31.9	—	—	31.9
—Partner Communication Co.	8.4	8.4	—	—
<i>Financial liabilities</i>				
—Other financial liabilities at FVTPL (derivative instruments)	142.3	—	142.3	—

Note 8—Segmental analysis

8.1 Definitions of segments

Given the geographic spread of the various Group entities, it logically follows that an analysis and control by geographical areas is inalienable to Group strategy of managing its different businesses. It has thus been decided by the Board of Managers to analyse the business across geographies and then by activity. The following geographies have been identified:

- Israel
- Belgium and Luxembourg (“Belux”)
- Portugal
- French Overseas Territories (“FOT”)
- Dominican Republic
- Others (Switzerland, others)

Activities have been split as follows:

- Fixed
- Mobile
- Others (Content/others)

Following the acquisition of ODO, Tricom and GLX, a new geographic segment, Dominican Republic, corresponding to the sole geographic zone of operation of these new entities, was added to the segmental analysis.

In addition, in the context of the anticipated acquisition and integration of the French mobile operator Société Française du Radiotéléphone S.A. (“SFR”) into the Altice S.A. Group, the Board of Directors of the latter has decided to amend the presentation of its operational segments, by regrouping the cable and B2B into a single line called ‘Fixed’, and by maintaining the mobile segment (SFR mainly has a mobile based activity). Other activities such as content, datacenters and holding company operations are classified under Others. Such presentation is coherent with the presentation used by the Board of Managers of the Group.

Though this acquisition does not directly impact the Group, Altice S.A. Board of Directors expects to track the operational performance of its international segments (operating companies that are part of the Altice International perimeter) on the same basis as its French businesses (Numericable Group S.A. and SFR in the future) and thus has decided to apply the same split at Altice International as well.

Altice International S.à r.l.

Notes to the condensed consolidated financial statements (Continued)

Note 8—Segmental analysis (Continued)

The presentation was amended for comparative purposes for the three and nine months ended September 30, 2013.

The businesses that the Group owns and operates do not show significant seasonality overall.

There are few operational transactions between the different segments defined by Management above. Intersegment revenues are considered to be non-material by Management and, hence, not in the scope of regular operational reviews. Intersegment revenues represented less than 0.5% of total revenues for the three and nine month periods ended September 30, 2014 and 2013, respectively.

All corporate entities revenues and expenses have been allocated to the segment “Others”.

8.2 Segment information

Details regarding revenues, cost of sales and gross profit for our cable, mobile and other segments are as follows. The reconciliation to Profit before income tax expenses is presented below in accordance with the requirements of IFRS 8 (operating segments).

	For the nine months ended September 30, 2014						Total
	Israel	Belux	Portugal	FOT	Dominican Republic	Others	
	(in € millions)						
Fixed							
Revenue	513.1	53.0	140.4	81.3	74.0	23.6	885.4
Purchase and subcontracting services . . .	(86.5)	(7.7)	(60.2)	(16.5)	(17.3)	(11.1)	(199.2)
Gross Profit	426.5	45.4	80.2	64.8	56.8	12.6	686.2
Mobile							
Revenue	132.8	1.0	—	97.4	226.5	—	457.7
Purchase and subcontracting services . . .	(42.1)	(1.2)	—	(26.2)	(49.2)	—	(118.7)
Gross Profit	90.7	(0.1)	—	71.2	177.3	—	339.1
Others							
Revenue	—	—	—	—	—	29.6	29.6
Purchase and subcontracting services . . .	—	—	—	—	—	(6.7)	(6.7)
Gross Profit	—	—	—	—	—	22.9	22.9
Total Revenue	645.9	54.0	140.4	178.7	300.5	53.2	1,372.8
Total purchase and subcontracting services .	(128.7)	(8.8)	(60.2)	(42.7)	(66.4)	(17.7)	(324.5)
Total Gross Profit	517.2	45.2	80.2	136.0	234.1	35.5	1,048.3
Profit/(loss) before income tax expenses .	31.8	0.8	(18.0)	24.8	76.8	(248.2)	(132.0)

Altice International S.à r.l.

Notes to the condensed consolidated financial statements (Continued)

Note 8—Segmental analysis (Continued)

	For the nine months ended September 30, 2013 (restated)					
	Israel	Portugal	Belux	FOT	Others	Total
	(In € millions)					
Fixed						
Revenue	527.0	100.9	52.4	37.1	25.5	742.9
Purchase and subcontracting services	(101.6)	(36.4)	(8.5)	(8.7)	(12.5)	(167.7)
Gross Profit	425.4	64.5	43.9	28.4	13.0	575.5
Mobile						
Revenue	142.4	—	0.8	32.7	—	175.9
Purchase and subcontracting services	(82.8)	—	(0.7)	(10.3)	—	(93.8)
Gross Profit	59.6	—	0.1	22.4	—	82.1
Others						
Revenue	—	—	—	—	9.3	9.3
Purchase and subcontracting services	—	—	—	—	(0.7)	(0.7)
Gross Profit	—	—	—	—	8.6	8.6
Total Revenue	669.4	100.9	53.2	69.8	35.1	928.4
Total Purchase and subcontracting services	(184.4)	(36.4)	(9.2)	(19.0)	(13.2)	(262.2)
Total Gross Profit	485.0	64.5	44.0	50.8	21.9	666.2
Profit/(loss) before income tax expenses	26.9	(19.1)	8.4	1.2	(79.4)	(62.0)

Note 9—Restructuring, non-recurring costs and other expenses/(income)

Restructuring, non-recurring costs and other expenses/(income) incurred in the three and nine month period ended September 30, 2014 pertain mainly to one-off payments and transaction costs relating to acquisitions or other similar operations. Details are given below:

	9 months ended September 30, 2014	9months ended September 30, 2013 (restated)	3 months ended September 30, 2014	3 months ended September 30, 2013 (restated)
	(in millions of euros)			
HOT Mobile restructuring costs (related to network sharing deal)	15.1	—	0.6	—
Restructuring costs (employee provisions, contract negotiations)	26.1	9.0	14.8	2.8
Restructuring costs	41.1	9.0	15.3	2.8
Fees related to the closing of the ODO transaction	7.0	—	0.3	—
Other deal fees/other income*	10.4	3.3	0.3	(6.0)
Deal fees and other non-recurring costs/(income)	17.4	3.3	0.6	(6.0)
Total Restructuring, non-recurring costs and other expenses/(income)	58.5	12.3	15.9	(3.5)

* Deal fees incurred in the three and nine month period ended September 30, 2013 mainly relate to fees paid for the HOT take private transaction (December 2012) and the Cabovisao minority stake buyout (April 2013). The other income recorded in the three months ended September 30, 2013 arose mainly due to the write back of some provisions.

Altice International S.à r.l.

Notes to the condensed consolidated financial statements (Continued)

Note 10—Related party transactions

10.1 Trading and financial transactions

Consolidated Income and expenses	Revenue		Operating expenses		Financial expenses	
	2013	2014	September 30,		2013	2014
			(€ in millions)			
Shareholders	—	—	—	—	—	(1.0)
Executive directors	—	—	(2.4)	(2.2)	—	—
Associated companies	—	6.1	—	(5.6)	(0.6)	(0.2)
TOTAL	—	6.1	(2.4)	(7.8)	(0.6)	(1.2)

Assets	Loans and receivables		Trade accounts receivable and other		Current accounts	
	Dec 31, 2013	September 30, 2014	Dec 31, 2013	September 30, 2014	Dec 31, 2013	September 30, 2014
			(€ in millions)			
Shareholders	—	—	0.2	—	—	—
Executive directors	—	—	—	—	—	—
Associated companies	—	0.6	0.8	5.9	—	0.3
TOTAL	—	0.6	1.0	5.9	—	0.3

Liabilities	Other financial liabilities		Trade accounts payable and other		Current accounts	
	Dec 31, 2013	September 30, 2014	Dec 31, 2013	September 30, 2014	Dec 31, 2013	September 30, 2014
			(€ in millions)			
Shareholders	99.2	46.0	—	—	—	—
Executive directors	—	—	—	—	—	—
Associated companies	—	1.5	6.6	17.1	—	—
TOTAL	99.2	47.5	6.6	17.1	—	—

Note 11—Compensation of key management personnel

The compensation given to the senior management of the Group (including those managers who are also board members of Altice S.A.), for the 9 month period ended September 30, 2014, was €3.4 million and €1.3 million for the 9 month period ended September 30, 2013 (€1.7 million and €0.3 million for the three months ended September 30, 2014 and 2013 respectively).

Note 12—Income tax

The Group registered an income tax expense of € 27.6 million for the nine month period ended September 30, 2014 compared to income tax expenses of €27.4 million for the nine month period ended September 30, 2013. For the nine month period ended September 30, 2014, the Group registered an income tax expense of €33.6 million, driven by increased profits in Israel and the Dominican Republic, which was offset by deferred tax credits of €7.5 million. For the comparative period ended September 30, 2013, the income tax expense was mostly composed of deferred tax expenses amounting to €21.9 million.

Note 13—Commitments and contingent liabilities

13.1.1 Provisions and contingent liabilities

13.1.1.A Israel

During the routine course of business, lawsuits have been filed against the companies that comprise the HOT group and various legal proceedings are outstanding against it.

Altice International S.à r.l.

Notes to the condensed consolidated financial statements (Continued)

Note 13—Commitments and contingent liabilities (Continued)

In the opinion of the management of the Group, based, inter alia, on legal opinions in respect of the chances of the lawsuits, a fair provision of €11.8 million (NIS 55 million) has been recorded in the condensed consolidated financial statements as of September 30, 2014, where provisions are required, in order to cover the exposure as the result of the lawsuits.

In the opinion of the management of the Group, the amount of the additional exposure, in an amount of approximately € 537.6 million (NIS 2.5 billion) (over and above the provisions that have been recorded in these Condensed Consolidated financial statements), as of September 30, 2014, as a result of lawsuits that have been filed against companies in the HOT group on various matters, is as follows:

- An amount of approximately €258.0 million (NIS 1.2 billion) to cover claims which HOT's management and legal team estimate to have less than a 50% chance of succeeding.
- An amount of approximately €172.0 million (NIS 0.8 billion) towards claims for which no assessment is possible, or towards those class action lawsuits that were presented very close to the date of the financial statements.
- An amount of approximately €150.5 million (NIS 0.7 billion) to cover claims which HOT's management and legal team estimate to have more than a 50% chance of succeeding.

The following is an abbreviated summary of the Hot group's contingent liabilities effective as of September 30, 2014, in accordance with groupings having similar characteristics:

<u>The nature of the lawsuit</u>	<u>The amount of the additional exposure in excess of the provision recorded as of September 30, 2014</u>	<u>The amount of the lawsuits that cannot be assessed and which were presented close to the date of the financial statements (primarily applications for approval as class actions)</u>	<u>Provisions recorded in the financial statements as of September 30, 2014</u>	<u>Provisions recorded in the financial statements as of December 31, 2013</u>	<u>Updating of the expense (income), net in the reporting period</u>
			(€ millions)		
Customers	522.5	162.4	2.6	4.3	(1.7)
Copyrights	1.1	0.6	3.7	6.5	(0.6)
Suppliers	14.2	—	0.9	0.4	0.4
Employees	1.3	—	0.2	0.2	0.2
The merger transaction . .	47.5	—	4.5	—	4.5
Total	<u>586.6</u>	<u>163.0</u>	<u>11.8</u>	<u>11.4</u>	<u>2.8</u>

13.1.1.B Portugal

As of September 30, 2014, the Oni Group and Cabovisao had bank guarantees given to third parties in order to secure the fulfilment of their obligations under some of their agreements for, respectively, a total amount of €5.3 million and €8.9 million.

As of September 30, 2014, Cabovisao recorded provisions for approximately €5.2 million for fiscal contingencies for withholding taxes. In addition, during first quarter 2014, the Instituto do Cinema e do Audiovisual ("ICA") rendered an unfavourable decision regarding the Audiovisual and Cinema taxation for which an amount of €0.9 million was already recorded in the consolidated financial statements as at December 31, 2013.

13.1.1.C Dominican Republic

As of September 30, 2014, Altice Hispaniola had recorded provisions to account for litigations with commercial customers and with employees. As assessed by the legal department, the total amount of

Altice International S.à r.l.

Notes to the condensed consolidated financial statements (Continued)

Note 13—Commitments and contingent liabilities (Continued)

claims amounted to € 69.0 million (DOP 3.8 billion) and the amount provided for, which is determined based on the probability of cash outflows, was assessed at €4.7 million (DOP 262.0 million), of which €4.0 million (DOP 240.6 million) related to commercial litigation and €0.4 million (DOP 21.4 million) related to employee litigation.

13.1.2 Commitments and contractual liabilities

Altice Hispaniola also has operating leases mainly for the rental of mobile tower sites and office property.

	<u>< 1 year</u>	<u>Maturity 1 - 5 years</u>	<u>> 5 years</u>	<u>Total September 30, 2014</u>
Operating leases	3.5	40.9	5.4	49.8
Total	3.5	40.9	5.4	49.8

Management has not identified any significant changes to the commitments of the other subsidiaries of the group as compared to the period ended December 31, 2013.

Note 14—Going concern

As of September 30, 2014, the Group had a net current liability position of €414.6 million (mainly due to current liabilities of €885.7 million). During the nine month period ended September 30, 2014, the Group recorded a net loss of €159.6 million (€89.4 million as of September 30, 2013), positive cash flow from operations of €503.8 million (€ 288.8 million for the nine months ended September 30, 2013), and negative working capital of €220.8 million. The positive cash flow from operations balance was mainly due to strong growth of the operating profit. The net loss recorded in the nine month period ended September 30, 2014 resulted mainly from finance costs related to the financial debt of the Group and revaluation of monetary items denominated in foreign currency.

The negative working capital position is structural and follows industry norms. Customers generally pay subscription revenues early or mid-month, with short DSOs (days of sales outstanding). Suppliers are generally paid from the beginning of the following month and after, thus generating a negative working capital, as evidenced by the difference in the level of receivables and payables (€292.9 million receivables as of September 30, 2014 compared to €535.6 million payable as of September 30, 2014). Payables due the following month are covered by revenues and operating cash (if needed). As of September 30, 2014, the Group had few short term current liabilities with amortization of debts limited to the local bonds in Israel (€ 13.4 million per half year), local debt in Switzerland (€1.2 million quarter) and on the Altice Financing term loan facility (€ 1.8 million per quarter).

As of September 30, 2014, the Company had a negative equity position of €93.2 million, of which €94.2 million attributable to the equity holders. The net equity position of the Company continued to improve (increase of € 167.9 million compared to the year ended December 31, 2013 (€ 261.2 million), mainly driven by the conversion of loans from related parties granted by Altice S.A. into share capital and share premium of the Company. Going forward, the Company will have access to capital markets through its sole shareholder, Altice S.A., and this is expected to further improve the equity position of the Company.

In view of the current financial situation of the Company, Management is confident that the Group will continue to act as a going concern for the next twelve months, given its earnings and cash flow generating ability.

In addition, the Group had cash reserves of €141.3 million as of September 30, 2014, considered sufficient to cover its operational needs. The Group also had access to revolving credit facilities (“RCF”) of up to €143.5 million to finance any liquidity needs it might have, which are undrawn as at September 30, 2014.

Note 15—Subsequent events

Additional investment in Wananchi

On October 2, 2014, Altice Africa S.à r.l., a 100% subsidiary of the Company, invested an additional \$ 10.8 million into Wananchi, a cable company with operations in Kenya and other east African countries. This investment was part of a \$ 130 million subordinated notes being issued by Wananchi and open to subscription by current and new shareholders. Altice Africa has pledged to fund up to \$ 40 million in three tranches, with the next tranche of \$ 20 million due within six months from the date of the payment of the first tranche (April 2, 2015). The notes bear cash interest at a rate of 11% or PIK interest at a rate of 13%. Before this additional investment, Altice Africa already held a 17.4% equity interest in Wananchi (valued at € 31.9 million) and convertible notes for a total of € 2.9 million. The Group also obtained a new board seat as part of the funding.

The new notes are also convertible at a strike price of \$ 1.15/ note issued. If fully converted, the new tranche, when fully funded, will give Altice Africa an approximate 21% shareholding in Wananchi.

Disposal of assets (OMT)

Following the French Competition Authority's conditional approval, obtained on October 27, 2014, to the purchase of SFR by Numericable Group S.A. and Altice S.A., the Company and Altice have agreed to dispose of the OMT's mobile business in the Reunion Islands and Mayotte. OMT's Indian Ocean assets are included respectively in the reporting segment French Overseas Territories (FOT) in note 8—Segment analysis.

In particular, the sale will include the 2G and 3G licenses and frequencies in Reunion Island and Mayotte, the customer base and the relevant personnel.

As these assets were not considered as assets held for sale, as of the date of the statement of financial position, as per the requirements of IFRS 5, Non-current assets held for sale and discontinued operations, no significant accounting impact has been recorded in the condensed consolidated financial statements of the Group for the period ended September 30, 2014.

Offer for Portugal Telecom

On November 30, 2014, Altice S.A., the sole shareholder of the Company announced an exclusivity agreement with Oi to agree the purchase of the Portuguese assets of Portugal Telecom excluding Portugal Telecom's Rio Forte debt securities.

The fully financed, binding offer values Portugal Telecom at an enterprise value of €7.4bn on a cash and debt-free free basis which includes €500m consideration related to the future revenue generation of Portugal Telecom.

The transaction, net of financial debt, accrued post-retirement liabilities and other purchase price adjustments will be financed by new debt and existing cash from the Group.

Should a final agreement be entered in to, the transaction will require corporate approvals and will be subject to standard regulatory approvals for a transaction of this nature.

Note 16—Approval of the condensed consolidated financial statements

The condensed consolidated financial statements were approved by the Board of Managers and authorized for issue on December 1, 2014.

To the Sole Partner of
Altice International S.à r.l.
3, boulevard Royal
L-2449 Luxembourg

REVIEW REPORT OF THE REVISEUR D'ENTREPRISES AGREE ON CONDENSED CONSOLIDATED FINANCIAL STATEMENTS

Introduction

We have reviewed the accompanying condensed consolidated statement of financial position of Altice International S.à r.l. as of September 30, 2014, the related condensed consolidated statements of income and other comprehensive income for the three month and nine month periods then ended, the related condensed consolidated statements of changes in equity and cash flows for the nine month period then ended and the other explanatory notes (collectively, the "Interim Financial Statements"). The Board of Managers is responsible for the preparation and fair presentation of the Interim Financial Statements in accordance with International Accounting Standard 34, *Interim Financial Reporting*, as adopted in the European Union. Our responsibility is to express a conclusion on these Interim Financial Statements based on our review.

Scope of Review

We conducted our review in accordance with International Standard on Review Engagements 2410, *Review of Interim Financial Information Performed by the Independent Auditor of the entity*. A review of interim financial information consists of making inquiries, primarily of persons responsible for financial and accounting matters, and applying analytical and other review procedures. A review is substantially less in scope than an audit conducted in accordance with International Standards on Auditing and consequently does not enable us to obtain assurance that we would become aware of all significant matters that might be identified in an audit. Accordingly, we do not express an audit opinion.

Conclusion

Based on our review, nothing has come to our attention that causes us to believe that the accompanying Interim Financial Statements are not prepared, in all material respects, in accordance with International Accounting Standard 34, *Interim Financial Reporting*, as adopted in the European Union.

For Deloitte Audit, *Cabinet de révision agréé*

John Psaila, *Réviseur d'entreprises agréé*
Partner
December 1, 2014

Altice VII S.à r.l.
(Société à responsabilité limitée)
Annual Report 2013



L-2449 Luxembourg, 3, boulevard royal
R.C.S. Luxembourg B 143.725
Share capital EUR 7,430,115.10

Table of contents

Report of the réviseur d'entreprises agréé	F-35
Consolidated statement of income for the year ended December 31, 2013	F-36
Consolidated statement of other comprehensive income for the year ended December 31, 2013	F-37
Consolidated statement of financial position as at December 31, 2013	F-38
Consolidated statement of changes in equity for the year ended December 31, 2013 ..	F-39
Consolidated statement of cash flows for the year ended December 31, 2013	F-40
Notes to the financial statements for the year ended December 31, 2013	F-41

REPORT OF THE REVISEUR D'ENTREPRISES AGREE

To the Sole Partner of
Altice VII S.à r.l.
3, boulevard Royal
L-2449 Luxembourg
Grand-Duchy of Luxembourg

Following our appointment by the Sole Partner, we have audited the accompanying consolidated financial statements of Altice VII S.à r.l., which comprise the consolidated statement of financial position as at December 31, 2013, and the consolidated statements of income, other comprehensive income, changes in equity and cash flows for the year then ended, and a summary of significant accounting policies and other explanatory information.

Responsibility of the Board of Managers for the consolidated financial statements

The Board of Managers is responsible for the preparation and fair presentation of these consolidated financial statements in accordance with International Financial Reporting Standards as adopted in the European Union, and for such internal control as the Board of Managers determines is necessary to enable the preparation of consolidated financial statements that are free from material misstatement, whether due to fraud or error.

Responsibility of the réviseur d'entreprises agréé

Our responsibility is to express an opinion on these consolidated financial statements based on our audit. We conducted our audit in accordance with International Standards on Auditing as adopted for Luxembourg by the *Commission de Surveillance du Secteur Financier*. Those standards require that we comply with ethical requirements and plan and perform the audit to obtain reasonable assurance whether the consolidated financial statements are free from material misstatement.

An audit involves performing procedures to obtain audit evidence about the amounts and disclosures in the consolidated financial statements. The procedures selected depend on the *réviseur d'entreprises agréé's* judgement including the assessment of the risks of material misstatement of the consolidated financial statements, whether due to fraud or error. In making those risk assessments, the *réviseur d'entreprises agréé* considers internal control relevant to the entity's preparation and fair presentation of the consolidated financial statements in order to design audit procedures that are appropriate in the circumstances, but not for the purpose of expressing an opinion on the effectiveness of the entity's internal control. An audit also includes evaluating the appropriateness of accounting policies used and the reasonableness of accounting estimates made by the Board of Managers, as well as evaluating the overall presentation of the consolidated financial statements.

We believe that the audit evidence we have obtained is sufficient and appropriate to provide a basis for our audit opinion.

Opinion

In our opinion, the consolidated financial statements give a true and fair view of the consolidated financial position of Altice VII S.à r.l. as of December 31, 2013, and of its consolidated financial performance and cash flows for the year then ended in accordance with International Financial Reporting Standards as adopted in the European Union.

For Deloitte Audit, *Cabinet de révision agréé*

John Psaila, *Réviseur d'entreprises agréé*
Partner

March 14, 2014

ALTICE VII S.à r.l.
Consolidated statement of income
For the year ended December 31, 2013

	Notes	Year ended December 31, 2013	Year ended December 31, 2012
(in millions of euros)			
Revenues	24	1,286.8	1,092.4
Purchases and subcontracting services	24	(367.8)	(302.1)
Other operating expenses	25	(185.5)	(162.5)
Staff costs and employee benefits expenses ⁽¹⁾		(134.7)	(145.3)
General and administrative expenses		(36.2)	(33.3)
Other sales and marketing expenses		(43.9)	(45.9)
Operating profit before depreciation, amortization and non-recurring costs(*)		518.8	403.2
Depreciation and amortization	26	(399.6)	(266.3)
Goodwill impairment		—	(121.9)
Other expenses, net	27	(15.1)	(29.8)
Management fees		(0.6)	(6.2)
Restructuring and other non-recurring costs	27	(61.2)	(20.8)
Operating profit/(loss)		42.3	(41.7)
Finance income	28	93.6	26.1
Finance costs	28	(336.9)	(200.0)
Loss before income tax expenses		(201.0)	(215.8)
Income tax (expenses)/benefit	23	(7.4)	26.0
Loss for the year		(208.4)	(189.8)
<i>Attributable to equity holders of the parent</i>		<i>(186.2)</i>	<i>(148.9)</i>
<i>Attributable to non-controlling interests</i>		<i>(22.2)</i>	<i>(40.9)</i>

(*) Operating profit before depreciation, amortization and non-recurring costs is further referred to as “EBITDA” in these consolidated financial statements.

(1) Staff costs and employee benefits have been reclassified for the year ended December 31, 2012 to reflect the total staff costs for all operating departments, i.e. technical and maintenance staff and marketing staff in order to match the new reporting requirements of the group. Such costs amounted to EUR 86.3 million for technical and maintenance staff and EUR 34.2 million for marketing staff and have been reclassified from the lines other operating expenses and other sales and marketing expenses respectively.

The accompanying notes form an integral part of these consolidated financial statements.

ALTICE VII S.à r.l.
Consolidated statement of other comprehensive income
For the year ended December 31, 2013

	<u>Notes</u>	<u>Year ended December 31, 2013</u>	<u>Year ended December 31, 2012</u>
		(in millions of euros)	
Loss for the year		(208.4)	(189.8)
Other comprehensive income			
Exchange differences on translating foreign operations		0.3	(5.1)
Net fair value gain on available-for-sale financial assets		1.7	—
Employee benefits		0.6	—
Total comprehensive loss for the year		<u>(205.9)</u>	<u>(194.9)</u>
<i>Attributable to equity holders of the parent</i>		<i>(183.8)</i>	<i>(152.6)</i>
<i>Attributable to non-controlling interests</i>		<i>(22.1)</i>	<i>(42.2)</i>

The accompanying notes form an integral part of these consolidated financial statements.

ALTICE VII S.à r.l.
Consolidated statement of financial position
December 31, 2013

	Notes	December 31, 2013	December 31, 2012
(in millions of euros)			
ASSETS			
Current assets			
Cash and cash equivalents	11	61.3	129.7
Restricted cash	11	1,242.8	—
Trade and other receivables	10	230.9	183.1
Inventories	9	11.0	6.1
Current tax assets	23	14.6	5.5
Total Current assets		<u>1,560.6</u>	<u>324.5</u>
Non-current assets			
Deferred tax assets	23	47.4	19.3
Financial assets	7	50.6	34.4
Trade and other receivables	8	22.8	24.6
Property, Plant & Equipment	6	1,134.2	1,067.8
Intangible assets	5	579.6	458.5
Goodwill	4	1,100.7	790.9
Total non-current assets		<u>2,935.4</u>	<u>2,395.5</u>
Total assets		<u>4,496.0</u>	<u>2,720.0</u>
EQUITY AND LIABILITIES			
Current liabilities			
Debentures	17	57.6	28.1
Borrowings from financial institutions	17	—	86.5
Deferred revenue	21	55.9	34.1
Trade and other payables	20	516.6	385.2
Other current liabilities	17	15.9	7.8
Provisions	14	2.1	—
Current tax liabilities	23	57.1	10.7
Total current liabilities		<u>704.9</u>	<u>552.5</u>
Non-current liabilities			
Debentures	17	2,527.0	1,108.5
Borrowings from financial institutions	17	894.3	257.2
Loans from related parties	17	99.2	109.0
Other financial liabilities	17	271.6	174.5
Provisions	14	29.0	25.6
Deferred revenue	21	10.6	10.8
Trade and other payables	20	29.0	38.8
Retirement benefit obligations	15	8.2	9.1
Deferred tax liabilities	23	183.1	148.2
Total non-current liabilities		<u>4,052.0</u>	<u>1,881.8</u>
Equity			
Issued capital	12	7.4	7.4
Share premium	12	5.4	—
Other reserves	13	(82.9)	277.5
(Accumulated losses)/Retained earnings		(4.5)	144.5
Net loss-attributable to the equity holders		(186.2)	(148.9)
Equity attributable to equity holders of the parent		<u>(260.7)</u>	<u>280.5</u>
Non-controlling interests	16	(0.5)	5.2
Total equity		<u>(261.2)</u>	<u>285.7</u>
Total equity and liabilities		<u>4,496.0</u>	<u>2,720.0</u>

The accompanying notes form an integral part of these consolidated financial statements.

ALTICE VII S.à r.l.
Consolidated statement of changes in equity
Year ended December 31, 2013

	Issued capital	Share Premium	Other reserves	Retained earnings	Net income	Total equity attributable to equity holders of the parent	Non-controlling interests	Total equity
	(in millions of euros)							
Equity at January 1, 2012 . . .	7.4	—	232.9	25.8	118.4	384.5	349.2	733.6
Allocation to retained earnings . . .	—	—	—	118.4	(118.4)	—	—	—
Loss for the year	—	—	—	—	(148.9)	(148.9)	(40.9)	(189.8)
Employee benefits	—	—	0.1	—	—	0.1	0.4	0.5
Variation in Currency								
Translation Reserve	—	—	(3.7)	—	—	(3.7)	(1.3)	(5.0)
Increase or decrease of ownership interest	—	—	(16.2)	—	—	(16.2)	21.6	5.4
Dividends paid	—	—	—	—	—	—	(26.0)	(26.0)
Option warrants	—	—	(3.9)	—	—	(3.9)	—	(3.9)
Purchase of non-controlling interests	—	—	68.3	—	—	68.3	(298.4)	(230.1)
Other variations	—	—	—	0.3	—	0.3	0.8	1.1
Equity at December 31, 2012 . .	7.4	—	277.5	144.5	(148.9)	280.5	5.2	285.7
Allocation to retained earning . . .	—	—	—	(148.9)	148.9	—	—	—
Loss for the year	—	—	—	—	(186.2)	(186.2)	(22.1)	(208.3)
Employee benefits	—	—	0.6	—	—	0.5	0.1	0.6
Variation in CPEC	—	—	(203.9)	—	—	(203.9)	—	(203.9)
Variation on Discounting								
Reserve	—	—	2.6	—	—	2.6	—	2.6
Variation in Currency								
Translation Reserve	—	—	0.1	—	—	0.1	0.2	0.3
Decrease/(increase) in ownership interest	—	—	(132.8)	—	—	(132.8)	16.0	(116.7)
Increase in equity	—	5.4	—	—	—	5.4	—	5.4
Integration of entities under common control	—	—	(31.2)	—	—	(31.2)	—	(31.2)
Other variations	—	—	4.2	—	—	4.2	0.1	4.3
Equity at December 31, 2013 . .	7.4	5.4	(82.9)	(4.4)	(186.2)	(260.7)	(0.5)	(261.2)

The accompanying notes form an integral part of these consolidated financial statements.

ALTICE VII S.à r.l.
Consolidated statement of cash flows
For the year ended December 31, 2013

	Notes	Year ended December 31, 2013	Year ended December 31, 2012
(in millions of euros)			
Net loss, including non-controlling interests		(208.3)	(189.8)
Adjustments for:			
Depreciation and amortization		399.6	388.2
Gains and losses on disposals	27	(1.0)	4.8
Other non-cash operating gains and losses		(13.0)	59.9
Net cash provided by operating activities before changes in working capital, finance costs and income tax		177.3	259.9
Finance costs recognized in profit and loss		232.1	174.0
Income tax (benefit)/expense recognized in the statement of income	23	7.4	(26.0)
Income tax (paid)/received		(2.3)	1.6
Changes in working capital		24.6	51.8
Net cash provided by operating activities		439.2	464.5
Purchases of tangible and intangible assets	5,6	(288.8)	(347.0)
Acquisitions of financial assets		(18.1)	(35.8)
Proceeds from disposal of tangible, intangible and financial assets		1.5	0.1
Increase/(decrease) in non-current financial assets		0.8	(16.1)
(Increase)/ use of restricted cash	11	(1,234.9)	32.6
Net cash (outflow)/inflow on acquisition of subsidiaries	3.3	(253.1)	(35.1)
Transactions with non-controlling interests	28	(120.9)	(172.9)
Net cash provided used by investing activities		(1,913.6)	(574.2)
Proceeds from issue of equity instruments	12	1.8	—
Dividends paid to non-controlling-interests	28	—	(26.0)
Proceeds from issuance of debts (*)	18	2452.0	891.5
Repayment of debt	17	(657.1)	(528.3)
Distribution to CPEC holders	13	(212.5)	—
Interest paid		(178.6)	(117.8)
Net cash provided in financing activities		1,405.6	219.3
Effects of exchange rate changes on the balance of cash held in foreign currencies		0.1	0.2
Net increase in cash and cash equivalents		(68.7)	109.9
Cash and cash equivalents at beginning of year	11	129.7	19.8
Net (decrease) / increase in cash and cash equivalents		(68.7)	109.9
Cash and cash equivalents at end of year	11	61.3	129.7

The accompanying notes form an integral part of these consolidated financial statements.

Altice VII S.à r.l.
Consolidated financial statements as of December 31, 2013

1—Notes to the consolidated financial statements

1.1 General description of the Group and its activities

Altice VII (the “Company”) is a private limited liability company (*société à responsabilité limitée*) incorporated under the laws of the Grand Duchy of Luxembourg on December 15, 2008, and registered under the number B 143.725 in Luxembourg. The Group refers to the Company and its subsidiaries. The Company was initially established as a public limited company (*société anonyme*) and then converted to a private limited liability company on October 7, 2009.

The registered office of the Company is established at 3, boulevard Royal, L-2449 Luxembourg, and as at December 31, 2013 its sole equity holder is NEXT LP. The ultimate controlling party is considered to be Patrick Drahi.

On January 31, 2014, Next LP contributed all its economic interests in Altice VII S.à r.l. (“The Group”) to Altice S.A. (“Altice”) in exchange for shares in Altice S.A.

Altice is listed on Euronext in Amsterdam. The consolidated financial statements, which include Altice VII Group are available at the registered address of Altice: 3, boulevard Royal, L-2449 Luxembourg and on its website : www.altice.net.

Altice VII offers a variety of services over its cable and mobile infrastructure, including, but not limited to, pay television, broadband Internet access, fixed-line telephony and mobile telephony to residential customers, and, to a lesser extent, corporate customers, depending on the country. Available cable-based service offerings depend on the bandwidth capacity of its cable networks and whether they have been upgraded for two-way communications. Where possible, Altice VII Group intends to deploy the same technologies and equipment across its footprints to generate economies of scale and common knowledge. In addition, the Altice VII group companies aim at sharing skills and best practices across the various operations of Altice VII Group.

Television service offerings include basic and premium programming, and, in most markets, incremental product and service offerings such as enhanced pay-per-view programming, including video-on-demand (“VoD”) and near-video-on-demand (“NVoD”), digital video recorders (“DVR”), high definition (“HD”) television services and, in certain areas, exclusive content, purchased or produced. The Group tailors its basic and premium channel line-up to each country of operation according to culture, demographics, programming preferences and local regulation. The Altice VII Group also offers broadband Internet access services and fixed-line telephony in all its footprints. It also owns and operates mobile infrastructures in certain geographies (French Overseas Territories) and offers mobile services through an MVNO (Mobile Virtual Network Operator) arrangement in Belgium.

1.2. Application of new and revised International Financial Reporting Standards (IFRSs)

1.2.1 New and revised IFRSs affecting amounts reported and/or disclosures in the financial statements:

In the current year, the Group has applied a number of new and revised IFRSs issued by the International Accounting Standards Board (IASB) and endorsed by the European Union.

New and revised Standards on consolidation, joint arrangements, associates and disclosures

In May 2011, a package of five standards on consolidation, joint arrangements, associates and disclosures was issued comprising IFRS 10 Consolidated Financial Statements, IFRS 11 Joint Arrangements, IFRS 12 Disclosure of Interests in Other Entities, IAS 27 (as revised in 2011) Separate Financial Statements and IAS 28 (as revised in 2011) Investments in Associates and Joint Ventures. Subsequent to the issue of these standards, amendments to IFRS 10, IFRS 11 and IFRS 12 were issued to clarify certain transitional guidance on the first-time application of the standards.

In the current year, the Group has early applied for the first time IFRS 10, IFRS 11, IFRS 12 and IAS 28 (as revised in 2011) together with the amendments to IFRS 10, IFRS 11 and IFRS 12 regarding the

Altice VII S.à r.l.
Consolidated financial statements as of December 31, 2013 (Continued)

1—Notes to the consolidated financial statements (Continued)

transitional guidance. IAS 27 (as revised in 2011) is not applicable to the Group as it deals only with separate financial statements.

The impact of the application of these standards is set out below.

Impact of the application of IFRS 10

IFRS 10 replaces the parts of IAS 27 Consolidated and Separate Financial Statements that deal with consolidated financial statements and SIC-12 Consolidation—Special Purpose Entities. IFRS 10 changes the definition of control such that an investor has control over an investee when a) it has power over the investee, b) it is exposed, or has rights, to variable returns from its involvement with the investee and c) has the ability to use its power to affect its returns. All three of these criteria must be met for an investor to have control over an investee. Previously, control was defined as the power to govern the financial and operating policies of an entity so as to obtain benefits from its activities. Additional guidance has been included in IFRS 10 to explain when an investor has control over an investee.

The Managers of the Company made an assessment as at the date of initial application of IFRS 10 (i.e. 1 January 2013) and have not identified any impact in the scope of consolidation linked to application of IFRS 10.

Impact of the application of IFRS 11

IFRS 11 replaces IAS 31 Interests in Joint Ventures and SIC 13 Jointly Controlled Entities—Non-Monetary Contributions by Venturers.

IFRS 11 deals with how a joint arrangement should be classified where two or more parties have joint control. There are two types of joint arrangements under IFRS 11: joint operations and joint ventures. These two types of joint arrangements are distinguished by parties' rights and obligations under the arrangements.

<u>Types of Joint Arrangement</u>	<u>Features</u>	<u>Accounting under IFRS 11</u>
Joint venture	Joint ventures have rights to the net assets of the arrangement.	Equity method of accounting—Proportionate consolidation is no longer allowed
Joint operation	Joint operators have rights to the assets and obligations for the liabilities of the arrangement.	Each joint operator recognizes its assets, liabilities, revenue and expenses relating to its interest in joint operation in accordance with the IFRSs applicable to those particular assets, liabilities, revenues and expenses

Under IFRS 11, the existence of a separate vehicle is no longer a sufficient condition for a joint arrangement to be classified as a joint venture whereas, under IAS 31, the establishment of a separate legal vehicle was the key factor in determining whether a joint arrangement should be classified as a jointly controlled entity.

Application of IFRS 11 has no impact on the consolidated financial statements of the Group for the year ended December 31, 2013.

Impact of the application of IFRS 12

IFRS 12 is a new disclosure standard and is applicable to entities that have interests in subsidiaries, joint arrangements, associates and/or unconsolidated structured entities. In general, the application of IFRS 12 has resulted in more extensive disclosures in the consolidated financial statements.

1—Notes to the consolidated financial statements (Continued)

IFRS 13 Fair Value Measurement

The Group has applied IFRS 13 for the first time in the current year. IFRS 13 establishes a single source of guidance for fair value measurements and disclosures about fair value measurements. The scope of IFRS 13 is broad; the fair value measurement requirements of IFRS 13 apply to both financial instrument items and non-financial instrument items for which other IFRSs require or permit fair value measurements and disclosures about fair value measurements, except for share-based payment transactions that are within the scope of IFRS 2 Share-based Payment, leasing transactions that are within the scope of IAS 17 Leases, and measurements that have some similarities to fair value but are not fair value (e.g. net realisable value for the purposes of measuring inventories or value in use for impairment assessment purposes).

IFRS 13 defines fair value as the price that would be received to sell an asset or paid to transfer a liability in an orderly transaction in the principal (or most advantageous) market at the measurement date under current market conditions. Fair value under IFRS 13 is an exit price regardless of whether that price is directly observable or estimated using another valuation technique. Also, IFRS 13 includes extensive disclosure requirements.

IFRS 13 requires prospective application from 1 January 2013. In addition, specific transitional provisions were given to entities such that they need not apply the disclosure requirements set out in the Standard in comparative information provided for periods before the initial application of the Standard. In accordance with these transitional provisions, the Group has not made any new disclosures required by IFRS 13 for the 2012 comparative period. Other than the additional disclosures, the application of IFRS 13 has not had any material impact on the amounts recognised in the consolidated financial statements.

Amendment to IFRS 7 disclosure—Offsetting Financial Assets and Financial Liabilities

The Group has applied the amendments to IFRS 7 disclosures—Offsetting financial assets and liabilities for the first time in the current period. The amendments to IFRS 7 require entities to disclose information about rights of offset and related arrangements (such as collateral pricing agreements) for financial instruments under an enforceable master netting agreement or similar arrangement.

The amendments have been applied retrospectively. As the Group does not have an offsetting arrangement in place, the application of the amendments has had no material impact on the disclosures or on the amounts recognised in the consolidated financial statements.

Annual improvements to IFRSs 2009-2011 cycle issued in May 2012

The Annual Improvements to IFRSs 2009-2011 Cycle include a number of amendments to various IFRSs. The amendments are effective for annual periods beginning on or after January 1, 2013. Amendments to IFRS include:

- Amendments to IAS 16 Property Plant and Equipment; and
- Amendments to IAS 32 Financial Instruments: Presentation.

Amendments to IAS 16

The amendments to IAS 16 clarify that spare parts, stand-by equipment and servicing equipment should be classified as property, plant and equipment when they meet the definition of the property, plant and equipment in IAS 16 and as inventory otherwise. This amendment does not have a significant impact on the Group's consolidated financial statements.

Amendments to IAS 32

The amendments to IAS 32 clarify that income tax relating to distributions to holders of an equity instrument and to transaction costs of an equity transaction should be accounted for in accordance with

1—Notes to the consolidated financial statements (Continued)

IAS 12 income taxes. This amendment does not have a significant impact on the Group's consolidated financial statements.

Standards issued but not yet effective

In its financial statements, the Group has not anticipated the following standards and interpretations, for which application is not mandatory for periods opened from January 1, 2013. Their impact on the Group's financial statements is estimated not to be significant and/or not applicable.

IAS 36 Impairment of Assets: Recoverable Amounts Disclosures for Non-Financial Assets

This standard's objective is to amend the disclosure requirements in IAS 36 Impairment of Assets with regard to the measurement of the recoverable amount of impaired assets that were made as a consequence of issuing IFRS 13 Fair Value Measurement in May 2011.

The group anticipates additional disclosures in relation to the application of this standard.

IAS 39 Financial Instruments: Recognition and Measurement and IFRS 9 Financial Instruments: Novation of derivatives and continuation of hedge accounting

This standard's objective is to provide an exception to the requirement for the discontinuation of hedge accounting in IAS 39 and IFRS 9 in circumstances when a hedging instrument is required to be novated to a central counterparty as a result of laws or regulations.

The group does not apply hedge accounting and therefore does not expect any impact from the application of this Standard.

2—Significant accounting policies

2.1 Significant accounting policies

The consolidated financial statements have been prepared in accordance with International Financial Reporting Standards as adopted by the European Union.

2.2 Basis of preparation

The consolidated financial statements have been prepared on the historical cost basis except for certain properties and financial instruments that are measured at revalued amounts or fair values at the end of each reporting period, as explained in the accounting policies below.

Historical cost is generally based on the fair value of the consideration given in exchange for goods and services.

Fair value is the price that would be received to sell an asset or paid to transfer a liability in an orderly transaction between market participants at the measurement date, regardless of whether that price is directly observable or estimated using another valuation technique. In estimating the fair value of an asset or a liability, the Group takes into account the characteristics of the asset or liability if market participants would take those characteristics into account when pricing the asset or liability at the measurement date. Fair value for measurement and/or disclosure purposes in these consolidated financial statements is determined on such a basis, except for share-based payment transactions that are within the scope of IFRS 2, leasing transactions that are within the scope of IAS 17, and measurements that have some similarities to fair value but are not fair value, such as net realisable value in IAS 2 or value in use in IAS 36.

2—Significant accounting policies (Continued)

In addition, for financial reporting purposes, fair value measurements are categorised into Level 1, 2 or 3 based on the degree to which the inputs to the fair value measurements are observable and the significance of the inputs to the fair value measurement in its entirety, which are described as follows:

Level 1 inputs are quoted prices (unadjusted) in active markets for identical assets or liabilities that the entity can access at the measurement date;

Level 2 inputs are inputs, other than quoted prices included within Level 1, that are observable for the asset or liability, either directly or indirectly; and

Level 3 inputs are unobservable inputs for the asset or liability.

The principal accounting policies are set out below.

2.3 Basis of consolidation

The consolidated financial statements incorporate the financial statements of the Company and entities (including structured entities) controlled by the Company and its subsidiaries. Control is achieved when the Company:

- has power over the investee;
- is exposed, or has rights, to variable returns from its involvement with the investee; and
- has the ability to use its power to affect its returns.

The Company reassesses whether or not it controls an investee if facts and circumstances indicate that there are changes to one or more of the three elements of control listed above.

When the Company has less than a majority of the voting rights of an investee, it has power over the investee when the voting rights are sufficient to give it the practical ability to direct the relevant activities of the investee unilaterally. The Company considers all relevant facts and circumstances in assessing whether or not the Company's voting rights in an investee are sufficient to give it power, including:

- the size of the Company's holding of voting rights relative to the size and dispersion of holdings of the other vote holders;
- potential voting rights held by the Company, other vote holders or other parties;
- rights arising from other contractual arrangements; and
- any additional facts and circumstances that indicate that the Company has, or does not have, the current ability to direct the relevant activities at the time that decisions need to be made, including voting patterns at previous shareholders' meetings.

Consolidation of a subsidiary begins when the Company obtains control over the subsidiary and ceases when the Company loses control of the subsidiary. Specifically, income and expenses of a subsidiary acquired or disposed of during the year are included in the consolidated statements of income and other comprehensive income from the date the Company gains control until the date when the Company ceases to control the subsidiary.

Profit or loss and each component of other comprehensive income are attributed to the owners of the Company and to the non-controlling interests. Total comprehensive income of subsidiaries is attributed to the owners of the Company and to the non-controlling interests even if this results in the non-controlling interests having a deficit balance.

When necessary, adjustments are made to the financial statements of subsidiaries to bring their accounting policies into line with the Group's accounting policies.

All intragroup assets and liabilities, equity, income, expenses and cash flows relating to transactions between members of the Group are eliminated in full on consolidation.

2—Significant accounting policies (Continued)

All companies in which the Group has a controlling interest are fully consolidated. The financial statements of subsidiaries are included in the consolidated financial statements from the date that control commences until the date that control ceases.

All intra-group transactions, balances, income and expenses are eliminated in full on consolidation. Non-controlling interests in subsidiaries are identified separately from the Group's equity therein.

2.4 Functional currency

The consolidated financial statements are presented in millions of euros. Euro is the functional of Altice VII and the presentation currency of the Group.

The functional currency, which is the currency that best reflects the economic environment in which the Group operates and conducts its transactions, is separately determined for each Group entity, including an associate accounted for using the equity method, and is used to measure its financial position and operating results.

2.5 Foreign currency translation

The presentation currency of the Group is euro. In individual companies, transactions in foreign currencies are recorded at the exchange rate at the date of the transaction. Monetary assets and liabilities in foreign currencies are translated at year-end rates. Any resulting exchange differences are accounted for in the income statement. On consolidation, assets and liabilities of the Group's entities reported in their functional currencies are translated into euro, the Group's presentation currency, using the year-end exchange rates. Income and expense items are translated into euro at the annual weighted average exchange rate or at the rate of the date the transaction occurred for significant items.

Differences arising from the translation of opening net assets of the Group entities, together with differences arising from the restatement of the net results for the year of the Group entities, are recognized in other comprehensive income.

2.6 Subsidiaries and associates

2.6.1 Subsidiaries

All companies in which the Group has a controlling interest are fully consolidated. Control exists when the Group has the power, directly or indirectly, to govern the financial and operating policies of an enterprise so as to obtain benefits from its activities. The financial statements of subsidiaries are included in the consolidated financial statements from the date that control commences until the date that control ceases.

All intra-group transactions, balances, income and expenses are eliminated in full on consolidation. Non-controlling interests in subsidiaries are identified separately from the Group's equity therein.

2.6.2 Associates

Investments, over which the Group exercises significant influence, but not control, are accounted for under the equity method. Such investees are referred to as "associates" throughout these consolidated financial statements.

Significant influence is presumed to exist when the Group holds at least 20% of the voting power in the associates. Associates are initially recognized at cost at acquisition date. The Consolidated Financial Statements include the Group's share of income and expenses, from the date significant influence commences until the date that significant influence ceases.

As per the provisions of IAS 28 *Investment in associates* the interest income and expenses recorded in the consolidated financial statements of the Group on loans with associates have not been eliminated in

2—Significant accounting policies (Continued)

the consolidated statements of income and therefore are still recorded in the consolidated financial statements.

2.7 Operating profit before depreciation, amortization and non-recurring costs

The Group has included the subtotal “Operating profit before depreciation, amortization and non-recurring costs” on the face of the consolidated statements of income. The Group believes that this subtotal is useful to users of the Group’s financial statements as it provides them with a measure of the operating results which excludes non-cash elements such as depreciation and amortization as well as non-recurring transactions and management fees, enhancing the predictive value of the Group’s financial statements and providing information regarding the results of the Group’s ongoing trading activities and cash-flow generation that allows investors to better identify trends in the Group’s financial performance.

This non-IFRS measure is used by the Group internally to manage and assess the results of its operations, make decisions with respect to investments and allocation of resources, and assess the performance of management personnel.

The Group’s subtotal within operating income may not be comparable to similarly titled measures used by other entities. Further, this measure should not be considered as an alternative for operating income as the effects of depreciation, amortization and impairment, excluded from this measure do ultimately affect the operating results, which is also presented within the consolidated financial statements in accordance with IFRS 1.

2.8 Revenue recognition

Revenue from the Group’s activities is mainly composed of television, broadband Internet, fixed and mobile telephony subscription and installations fees invoiced to residential and business clients.

Revenue comprises the fair value of the consideration received or receivable for the sale of goods and services in the ordinary course of the Group’s activities. Revenue is shown net of value-added tax, returns, rebates and discounts and after eliminating intercompany sales within the group.

Revenues on bundle packages sold by the Group are split into and recognised under each individual service sold in the bundle. For example, tripe play package revenues are booked under ‘triple play television’, ‘triple play data’ and ‘triple play telephony’ on a straight-line basis over their subscription period and revenues from telephone calls are recognized in revenue when the service is rendered.

Revenue is recognized as follows, in accordance with IAS 18 *Revenue*:

- Revenues from subscriptions for basic cable services, digital television pay, Internet and telephony (fixed and mobile) are recognized in revenue on a straight-line basis over the subscription period; revenues from telephone calls are recognized in revenue when the service is rendered ;
- When a promotion not related to a customer’s past consumption and purchases (such as subscription’s rate discount, service free period) is offered to customer in relation to a subscription, the Group recognizes the total amount of billable revenue on a straight-line basis over the term of the contract ;
- Installation and set-up fees (including connection) for residential customers are accounted for as revenues when the service is rendered, if consideration received is lower than the sales direct costs to acquire the contractual relationship. Service access fees for business clients, when they are only allowed access to the services that are sold associated to an equipment or a service, are deferred and the corresponding revenue is recognized along the statistical client lifetime duration and generally spread over the contractual engagement period ; and

2—Significant accounting policies (Continued)

- The revenue related to transmission capacity on terrestrial cables under indefeasible rights of use: Indefeasible Rights of Use (“IRU”) arrangements are recognized on a straight-line basis over the life of the contract.

Revenues from mobile services resulting from the sale of mobile services:

- Revenues from the sale of equipment includes the sale of mobile devices and ancillary equipment for those devices. The revenues from the sales are recognized where all of the significant risk and yields that are derived from the ownership of the equipment are transferred to the purchaser and the seller does not retain continuing managerial involvement. Generally, the time of the delivery is the time at which ownership is transferred. The charge in respect of terminal equipment is made separately from the monthly charge for the consumption of services, in accordance with the amounts that is denoted in a separate invoice, which reflects the fair value of the terminal equipment, which is not subsidized by the Group. In the light of the aforesaid, the Group recognizes revenues in respect of the sale of devices on the transfer of the ownership of the devices to its customers. The revenues are recognized on the first day in accordance with its fair value as of that time and the difference between the fair value and the denoted amount of the consideration is recognized as financing income over the course of the period of the installment payments.

Income from credit arrangements

- Revenues deriving from long-term credit arrangements (such as the sale of devices in installments) are recorded on the basis of the present value of the future cash flows (against long-term receivables) and are discounted in accordance with interest rates. The difference between the original amount of the credit and the present value, as aforesaid, is spread over the length of the credit period and recorded as interest income over the length of the credit period.

2.9 Finance costs

Finance costs primarily comprise:

- Interest charges and other expenses paid for financing operations recognized at amortized costs ;
- Changes in the fair value of interest rate derivative instruments that do not qualify as hedges for accounting purposes according to “IAS 39” ;
- Interest income relating to cash and cash equivalents; and
- Gains/losses on extinguishment of debt.

2.10 Income taxes

Taxes on income in the income statement include current taxes and deferred taxes. The tax expenses or income in respect of current taxes or deferred taxes are recognized in profit or loss unless they relate to items that are recorded directly in equity, in these cases the tax effect is reflected under the relevant equity item.

2.10.1 Current taxes

The current tax liability is measured using the tax rates and tax laws that have been enacted or substantively enacted by the end of reporting period as well as adjustments required in connection with the tax liability in respect of previous years.

2—Significant accounting policies (Continued)

2.10.2 Deferred taxes

Differences existing at closing between the tax base value of assets and liabilities and their carrying value in the Consolidated Statement of Financial Position give rise to temporary differences. Pursuant to the liability method, these temporary differences result in the accounting of:

- Deferred tax assets, when the tax base value is greater than the carrying value (expected future tax saving),
- Deferred tax liabilities, when the tax base value is lower than the carrying value (expected future tax expense).

Deferred tax assets and liabilities are measured at the expected tax rates for the year during which the asset will be realized or the liability settled, based on tax rates (and tax regulations) enacted or substantially enacted by the closing date. They are reviewed at the end of each year, in line with any changes in applicable tax rates.

Deferred tax assets are recognized for all deductible temporary differences, tax loss carry-forwards and unused tax credits, insofar as it is probable that a taxable profit will be available, or when a current tax liability exists to make use of those deductible temporary differences, tax loss carry-forwards and unused tax credits, except where the deferred tax asset associated with the deductible temporary difference is generated by initial recognition of an asset or liability in a transaction which is not a business combination, and that, at the transaction date, does not impact earnings, nor income tax profit or loss.

For deductible temporary differences arising from investments in subsidiaries, joint ventures and other associated entities, deferred tax assets are recorded to the extent that it is probable that the temporary difference will reverse in the foreseeable future and that a taxable profit will be available against which the temporary difference can be utilized.

The carrying value of deferred tax assets is reviewed at each closing date, and revalued or reduced to the extent that it is more or less probable that a taxable profit will be available to allow the deferred tax asset to be utilized. When assessing the probability of a taxable profit being available, account is taken, primarily, of prior years' results, forecasted future results, non-recurring items unlikely to occur in the future and the tax strategy. As such, the assessment of the group's ability to utilize tax losses carried forward is to a large extent judgment-based. If the future taxable results of the group proved to differ significantly from those expected, the group would be required to increase or decrease the carrying value of deferred tax assets with a potentially material impact on the Consolidated Statement of Financial Position and Consolidated Income Statement of the Group.

Deferred tax liabilities are recognized for all taxable temporary differences, except where the deferred tax liability results from goodwill or initial recognition of an asset or liability in a transaction which is not a business combination, and that, at the transaction date, does not impact earnings, nor income tax profit or loss.

For taxable temporary differences arising from investments in subsidiaries, joint ventures and other associated entities, deferred tax liabilities are recorded except to the extent that both of the following conditions are satisfied: the parent, investor or venturer is able to control the timing of the reversal of the temporary difference and it is probable that the temporary difference will not be reversed in the foreseeable future.

Current tax and deferred tax shall be charged or credited directly to other comprehensive income, and not earnings, if the tax relates to items that are credited or charged directly to other comprehensive income.

2.11 Goodwill and business combinations

Business combinations, not occurring under common control, are accounted for in accordance with the purchase method. The acquiree's identifiable assets, liabilities and contingent liabilities that meet the

2—Significant accounting policies (Continued)

conditions for recognition under IFRS 3 “Business combinations” are recognized at their fair value at acquisition date.

The Group recognizes goodwill as of the acquisition date and is measured as the excess of (a) over (b) as follows :

a) *The aggregate of:*

- The consideration transferred, which generally requires acquisition-date fair value;
- The amount of any non-controlling interests in the acquiree measured;
- In a business combination achieved in stages, the acquisition-date fair value of the acquirer’s previously held equity interest in the acquiree.

b) The net of the acquisition-date balances of the identifiable assets acquired and the liabilities measured in accordance with IFRS 3.

Any excess of the cost of acquisition over the Group’s share in the fair value of all identified assets and liabilities is recognized as goodwill.

The goodwill is determined provisionally by the end of the period. The Group recognizes any adjustments to those provisional values within twelve months after the acquisition date.

During the measurement period, the acquirer shall recognize adjustments to the provisional amounts as if the accounting for the business combination had been completed at the acquisition date. Thus, the acquirer shall revise comparative information for prior periods presented in financial statements as needed, including making any change in depreciation, amortization or other income effects recognized in completing the initial accounting.

If the net of the acquisition-date amounts of the identifiable assets acquired and the liabilities assumed exceeds the purchase price, a gain is recognized immediately.

Subsequently, goodwill is measured at its initial amount less recorded accumulated impairment losses. Impairment loss for goodwill is recorded in the income statement as a deduction from operating income (account “Depreciation and amortization”) and is never reversed subsequently.

Changes in the Group’s ownership interests in subsidiaries that do not result in the Group losing control over the subsidiaries are accounted for as equity transactions. The carrying amounts of the Group’s interests and the non-controlling interests are adjusted to reflect the changes in their relative interests in the subsidiaries. Any difference between the amount by which the non-controlling interests are adjusted and the fair value of the consideration paid or received is recognized directly in equity and attributed to owners of the Group.

For acquisitions under common control, the Group does not perform a purchase price allocation. Any difference between the consideration paid and the book value of the net assets acquired is directly attributed to the reserves of the Group and no residual goodwill is recorded.

2.12 Other intangible assets

Intangible assets acquired separately are recorded at cost on initial recognition, with the addition of direct acquisition costs. Intangible assets acquired in a business combination are measured at fair value as of the date of acquisition. Following initial recognition, intangible assets are carried at cost less any accumulated amortization and less any accumulated impairment losses. In our Israeli entity, the costs of producing in-house content is also considered to be an intangible assets and recognized at the cost of production of the shows. Following initial recognition, these intangible assets are carried at cost less any accumulated amortization and less any accumulated impairment losses.

According to Management, intangible assets have either definite or indefinite useful lives.

2—Significant accounting policies (Continued)

Assets with definite useful lives are amortized over their useful lives and assessed for impairment signs which would indicate impairment in value. The amortization period and the amortization method for an intangible asset with a finite useful life are reviewed at least once a year. Changes in the expected useful life or the expected pattern of consumption of future economic benefits that are expected to derive from the asset are treated as a change in an accounting estimate which is treated prospectively. The amortization expenses regarding intangible assets with finite useful lives are recognized in the income statement.

The useful lives of the intangible assets are as follows:

	Duration
Software	3 years
Customer relations	7 to 37 years
Licences	5 years
Customer relations with a defined contractual term . .	3 years
Subscriber purchase costs	based on average duration of subscriptions

Assets with indefinite useful lives are tested for impairment annually as well as where there is an indication that it may be impaired by comparing their carrying amount with their recoverable amount.

2.13 Impairment of tangible and intangible assets

Each time events or changes in the economic environment indicate a current risk of impairment of goodwill, other intangible assets, property, plant and equipment and assets in progress, the Group re-examines the value of these assets. In addition, goodwill, other intangible assets with an indefinite useful life, and intangible assets in progress are all subject to an impairment test performed annually.

This test is performed in order to compare the recoverable amount of an asset to its carrying amount.

An asset's recoverable amount is the higher of an asset's fair value less costs to sell and its value in use. Recoverable amount is determined for an individual asset, unless the asset does not generate cash inflows that are largely independent of those from other assets or groups of assets. In that case, recoverable amount is determined for the cash-generating unit to which the asset belongs. A Cash Generating Unit ("CGU") is the smallest identifiable group of assets that generates cash inflows that are largely independent of the cash inflows from other assets or groups of assets.

The value in use of each asset or group of assets is determined as the discounted value of future cash flows (discounted cash flow method or "DCF") by using a discount rate after tax specific to each asset or group of assets concerned.

The fair value less costs to sell is the amount obtained from the sale of the asset or group of assets in an arm's length transaction between knowledgeable and willing parties, less costs to sell.

When the carrying amount of an asset exceeds its recoverable amount, an impairment loss is recognized in the caption "Depreciation and amortization" in the income statement. Only impairment loss recognized on assets other than goodwill such as depreciable intangible assets, intangible assets with indefinite useful life and property, plant and equipment, may be reversed.

2.14 Property, plant and equipment

Property, plant and equipment are presented at cost with the addition of direct purchase costs less accumulated depreciation and accumulated losses on impairment and they do not include routine maintenance expenses. The cost includes spare parts and ancillary equipment that can only be used in connection with the plant and machinery.

2—Significant accounting policies (Continued)

Depreciation is calculated using the straight line method over the estimated useful lives of the assets, as follows:

	<u>Duration</u>
Buildings	25 to 50 years
Cables Network	4 to 20 years
Call center (primarily electronic equipment)	5 to 9 years
Converters and modems	7 years
Computers and ancillary equipment.	3 to 6 years
Office furniture and equipment	6 to 16 years
Communication network infrastructure	6 to 16 years
Leasehold contracts	see below

Leasehold contracts are depreciated according to the straight line method during the rental period (including the option period for an extension by the Group, which it intends to exercise) or the estimated useful lifetime of the improvement.

Elements of a fixed asset item, having a cost that is significant in comparison to the overall cost of the item, are depreciated separately, using the components method. The depreciation is calculated in accordance with the straight line method at annual rates that are considered to be sufficient in order to depreciate the assets over the length of their estimated useful lives.

The useful life, depreciation method and residual value of an asset are reviewed at least annually and any changes are accounted for prospectively as a change in accounting estimate.

2.15 Leasing

Leases are classified as finance leases whenever the terms of the lease transfer substantially all the risks and rewards of ownership to the lessee. All other leases are classified as operating leases.

2.15.1 The Group as lessor

Amounts due from lessees under finance leases are recognized as receivables at the amount of the Group’s net investment in the leases. Finance lease income is allocated in an accounting periods so as to reflect a constant periodic rate of return on the Group’s net investment outstanding in respect of the leases.

Rental income from operating leases is recognized on a straight-line basis over the term of the relevant lease. Initial direct costs incurred in negotiating and arranging an operating lease are added to the carrying amount of the leased asset and recognized on a straight-line basis over the lease term.

Rental income from the leasing of customer premises equipment (set top boxes, modems and decoders) is recognized on a straight-line basis over the term of the subscription held by the client. At the end of the contract or in case of voluntary contract termination by the client, this equipment is repossessed and thus remains in the inventory of the Group.

2.15.2 The Group as lessee

Assets held under finance leases are initially recognized as assets of the Group at their fair value at the inception of the lease or, if lower, at the present value of the minimum lease payments. The corresponding liability to the lessor is included in the consolidated statement of financial position as a finance lease obligation.

Lease payments are apportioned between finance expenses and reduction of the lease obligation so as to achieve a constant rate of interest on the remaining balance of the liability. Finance expenses are recognized immediately in profit or loss, unless they are directly attributable to qualifying assets, in which case they are capitalized in accordance with the Group’s general policy on borrowing costs (see

2—Significant accounting policies (Continued)

note 2.16 below). Contingent rentals are recognized as expenses in the periods in which they are incurred.

Operating lease payments are recognized as an expense on a straight-line basis over the lease term, except where another systematic basis is more representative of the time pattern in which economic benefits from the leased asset are consumed. Contingent rentals arising under operating leases are recognized as an expense in the period in which they are incurred.

In the event that lease incentives are received to enter into operating leases, such incentives are recognized as a liability. The aggregate benefit of incentives is recognized as a reduction of rental expense on a straight-line basis, except where another systematic basis is more representative of the time pattern in which economic benefits from the leased asset are consumed.

2.16 *Borrowing costs*

Borrowing costs that are directly attributable to the acquisition, construction or production of a qualifying asset are capitalized as part of the cost of that asset. According to management, it does not take a substantial period of time to get ready for the intended use because of the incremental deployment of the network. This standard has consequently no impact on the consolidated financial statements.

2.17 *Government grants*

Government grants are not recognized until there is reasonable assurance that the Group will comply with the conditions attaching to them and that the grants will be received.

Government grants are recognized in profit or loss on a systematic basis over the periods in which the Group recognizes as expenses the related costs for which the grants are intended to compensate. Specifically, government grants whose primary condition is that the Group should purchase, construct or otherwise acquire non-current assets are recognized as deferred revenue in the consolidated statement of financial position and transferred to the income statement on a systematic and rational basis over the useful lives of the related assets.

Government grants that are receivable as compensation for expenses or losses already incurred or for the purpose of giving immediate financial support to the Group with no future related costs are recognized in profit or loss in the period in which they become receivable.

The benefit of a government loan at a below-market rate of interest is treated as a government grant, measured as the difference between proceeds received and the fair value of the loan based on prevailing market interest rates.

2.18 *Financial assets*

The Group classifies financial assets in four categories: available-for-sale, loans and receivables, held-to-maturity and financial assets at fair value through profit and loss. They are classified as current assets and non-current assets according to IAS 1 “Presentation of financial statements”.

Purchases and sales of all financial assets are recognized on a trade date basis.

2.18.1 *Available-for-sale financial assets*

Available-for-sale financial assets are recognized initially at fair value plus transaction costs that are directly attributable to the acquisition or issue of the financial asset. After initial recognition, they are reported at their fair value. Gains and losses arising from changes in their fair value are recognized directly in equity, until the security is disposed of or is determined to be impaired, at which time the cumulative gain or loss previously recognized in equity is included in the profit or loss for the period.

Available-for-sale financial assets consist mainly of shares in non-consolidated companies. Fair value corresponds to quote price for listed securities. For non-listed securities, and when a reliable estimate of

2—Significant accounting policies (Continued)

fair value cannot be made using valuation techniques, the group values financial assets at historical cost, less any impairment losses.

When there is objective evidence that available-for-sale assets are impaired, the cumulative impairment loss included in equity is reclassified from other comprehensive income to income. Objective evidence that an available-for-sale financial asset is impaired includes, among other things, a decrease in the estimated future cash flows arising from these assets, as a result of significant financial difficulty of the issuer, a material decrease in expected future profitability or a prolonged decrease in the fair value of the security. Impairment losses recognized in profit or loss for equity instruments classified as available-for-sale are never reversed through profit or loss.

2.18.2 Loans and receivables

Loans and receivables are recognized initially at fair value plus transaction costs that are directly attributable to the acquisition. After initial recognition, they are measured at amortized cost using the effective interest rate method.

This category mainly includes trade receivables.

If there is objective evidence that an impairment loss has occurred, the amount of this loss, measured as the difference between the financial assets' carrying value and its recoverable amount is recognized in the income statement. Impairment losses may be reversed if the recoverable amount of the asset subsequently increases in the future.

2.18.3 Held-to-maturity financial assets

Held-to-maturity financial assets are financial assets with fixed or determinable payments and fixed maturity that the Group has both the intention and ability to hold to maturity. Financial assets that are designated as held-to-maturity are measured at amortized cost, in accordance with the effective interest rate method.

They are reviewed for impairment on an individual basis if there is any indication that they may be impaired.

The Group currently does not hold any held to maturity financial assets.

2.18.4 Financial assets measured at fair value through profit or loss

These financial assets are measured at fair value with gains and losses recorded as finance income or costs.

This category mainly includes:

- Assets held for trading which the Group intends to sell in the near future (primarily marketable securities);
- Assets voluntarily classified at inception in this category;
- Derivatives financial assets.

2.19 Inventories

Inventories are measured at the lower of cost and net realizable value. The cost of inventories comprises costs of purchase and costs incurred in bringing the inventories to their present location and condition. Net realizable value is the estimated selling price in the ordinary course of business less the estimated costs of completion and the estimated selling costs.

Cost of inventories is determined using the weighted average cost method.

2—Significant accounting policies (Continued)

The Group periodically evaluates the condition and age of inventories and makes provisions for slow moving inventories accordingly.

2.20 Cash and cash equivalents

Cash consists of cash in banks and deposits.

Cash equivalents are considered as highly liquid investments, including unrestricted short-term bank deposits with an original maturity of three months or less from the date of acquisition or with a maturity of more than three months, but which are redeemable on demand without penalty and which form part of the Group's cash management.

2.21 Restricted cash

Restricted cash is considered to be cash that is dedicated to the repayment of the Group's liabilities to banking entities in accordance with the Group's credit agreement and therefore amounts that the Group cannot use at its discretion.

Restricted cash can also consist of cash held in escrow to finance certain acquisitions (in the period between the agreement to acquire and the actual closing of the acquisition and the transfer of shares and cash and other considerations). Restricted cash may also consist of guarantees provided by different Group companies to financial institutions related to financing or other activities.

2.22 Derivatives

Derivatives are initially recognized at fair value on the date a derivative contract is entered into and are subsequently reassessed at their fair value.

The Group enters into interest rate swaps and caps to manage its interest or foreign currency exchange rate exposure. These contracts do not qualify as hedges for accounting purposes according to IAS 39, as there was no formal designation and documentation of the hedging relationship at inception. Changes in the fair value of any of these derivative instruments are recognized immediately in the income statement within financial income and expenses.

2.23 Share based payment arrangements

The Group's employees are entitled to remuneration in the form of equity-settled share-based payment transactions and certain employees are entitled to remuneration in the form of cash-settled share-based payment transactions that are measured based on the increase in the Company's share price. These stock options based remunerations mainly concerned the Israeli entity, HOT Telecom and these plans were terminated post the take private of the company in December 2012 and the delisting of all active shares of HOT Telecom on the Tel Aviv stock exchange.

2.24 Financial liabilities

Financial liabilities other than derivative instruments include:

2.24.1 Financial liabilities at amortized cost

These financial liabilities are measured at amortized cost calculated based on the effective interest rate method according to IAS 39. The effective interest rate is the internal yield rate that exactly discounts future cash flows through the term of the financial liability. Fees, debt issuance and transaction costs are included in the calculation of the effective interest rate over the expected life of the instrument.

2.24.2 Financial liabilities that are measured at fair value through profit or loss

Financial liabilities at fair value through profit or loss include financial liabilities classified as held for trading and financial liabilities designated upon initial recognition as at fair value through profit or loss.

2—Significant accounting policies (Continued)

Financial liabilities are classified as held for trading if they are acquired for the purpose of sale in the near term. Gains or losses on liabilities held for trading are recognized in profit or loss.

Derivatives, including bifurcated embedded derivatives, are classified as held for trading unless they are designated as effective hedging instruments. In the event of a financial instrument that contains one or more embedded derivatives, the entire combined instrument may be designated as a financial liability at fair value through profit or loss only upon initial recognition.

The Group assesses whether embedded derivatives are required to be bifurcated from host contracts when the Group first becomes party to the contract. Reassessment only occurs if there is a change in the terms of the contract that significantly modifies the cash flows that would otherwise be required.

The fair value of financial instruments that are traded in an active market is determined by reference to quoted market prices at the close of business on the balance sheet date. For financial instruments for which there is no active market, fair value is determined by the use of valuation techniques. Such techniques include evaluation based on transactions that have been executed recently under market terms, reference to the current market value of another instrument, which is substantially the same, discounted cash flow analysis or other valuation models.

2.24.3 Classification as debt or equity

Debt and equity instruments issued by a group entity are classified as either financial liabilities or as equity in accordance with the substance of the contractual arrangements and the definitions of a financial liability and an equity instrument.

2.24.4 Equity instruments

An equity instrument is any contract that evidences a residual interest in the assets of an entity after deducting all of its liabilities. Equity instruments issued by a group entity are recognized at the value of the proceeds received, net of direct issue costs.

Repurchase of the Company's own equity instruments is recognized and deducted directly in equity. No gain or loss is recognized in profit or loss on the purchase, sale, issue or cancellation of the Company's own equity instruments.

The Group also issued some CPECs (Convertible Preferred Equity Certificates). Details of these subordinated financial instruments are set out in note 17.4.

2.25 Other liabilities

2.25.1 Provisions

A provision in accordance with IAS 37 is recognized in the statement of financial position when the Group has a present obligation (legal or implicit) as the result of a past event and it is expected that the use of economic resources will be required in order to settle the obligation and it is possible to reliably estimate it. Where the impact is significant, the provision is measured by discounting the forecasted future cash flows, using a pre-tax interest rate that reflects the expectations of the market in respect of the time frame of the money and in certain cases, the risks that are specific to the liability.

The following types of provisions are recorded in the financial statements:

2.25.2 Legal claims

A provision regarding legal claims is recognized when the Group has a present legal commitment or an implicit commitment resulting from a past event; when it is more likely than not that the Group will be required to expend economic resources to clear the commitment, when it is possible to estimate it reliably and when the effect of time is significant, the provision is measured according to the present value.

2—Significant accounting policies (Continued)

2.25.3 Warranty

The Group recognizes a provision for warranty for the sale of its products. The warranty is limited to malfunctions as defined by the Group and does not include warranty for damages incurred by the customer.

2.25.4 Onerous contracts

Present obligations arising under onerous contracts are recognized and measured as provisions. An onerous contract is considered to exist where the Group has a contract under which the unavoidable costs of meeting the obligations under the contract exceed the economic benefits expected to be received from the contract.

2.25.5 Restructuring

A restructuring provision is recognized when the Group has developed a detailed formal plan for the restructuring and has raised a valid expectation in those affected that it will carry out the restructuring by starting to implement the plan or announcing its main features to those affected by it. The measurement of a restructuring provision includes only the direct expenditures arising from the restructuring, which are those amounts that are both necessarily entailed by the restructuring and not associated with the ongoing activities of the Group.

2.26 Liabilities for employment benefits

In accordance with the laws and practices of each country in which it operates, the Group participates in, or maintains, several employee benefits. There are as follows:

2.26.1 Short-term benefits for employees

Short-term benefits for employees include salaries, vacation pay, sick leave, recuperation pay and employers' deposits for national insurance and are recognized as an expense when the services are provided. A liability in respect of a cash bonus or a profits participation scheme is recognized where the Group has a legal or an implicit commitment to pay the said amount in respect of service that has been provided by the employee in the past and where the amount can be reliably estimated.

2.26.2 Post-retirement benefits

In Israel, the Group operates a defined benefits plan in respect of the payment of severance pay in accordance with the Israeli Severance Pay Law. According to this law, employees are entitled to receive severance pay if they are dismissed or on their retirement. The liability in respect of the termination of employee-employer relations is measured in accordance with the actuarial value of a forecast unit of entitlement method. The actuarial calculation takes into account increases in salaries in the future and the rate at which employees leave the Group and this on the basis of an estimate of the timing of the payment. The amounts are presented on the basis of the discounting of the forecast future cash flows, in accordance with government bonds' interest rates, whose repayment dates are close to the period relating to the liability in respect of severance pay.

The Group deposits funds in respect of its severance pay liability in pension funds and insurance companies (hereafter—the plan assets). The plan assets are assets that are held by the employee benefits plan for the long-term or in qualifying insurance policies. The plan assets are not available for use by the Group's creditors, and cannot be paid directly to the Group.

The liability regarding employee benefits presented in the statement of financial position represents the present value of the defined benefits obligation less the fair value of the plan assets, and the past service costs. Actuarial gains and losses are reflected in the income statement in the period in which they arise, as part of the salary costs.

2—Significant accounting policies (Continued)

The Group has defined contribution plans pursuant to the Severance Pay Law under which the Group pays fixed contributions and will have no legal or constructive obligation to pay further contributions if the fund does not hold sufficient amounts to pay all employee benefits relating to employee service in the current and prior periods. Contributions to the defined contribution plan in respect of severance or retirement pay are recognized as an expense when contributed simultaneously with receiving the employee's services and no additional provision is required in the financial statements.

2.26.3 Other long-term employee benefits

The Group's employees are entitled to benefits and other long-service grants. These benefits are accounted for as other long-term benefits since the Group estimates that these benefits will be used and the respective Group's obligation will be settled during the employment period and after one year from the end of the reporting period.

The Group's net obligation regarding other long-term employee benefits is in respect of the future benefit amount due to employees for services rendered in current and prior periods. This amount of benefits is discounted to its present value and the fair value of the assets relating to this obligation is deducted from said amount. The discount rate is determined by reference to the yields on Government bonds whose currency and term are consistent with the currency and term of the Group's obligation. The obligation is calculated using the projected unit credit method. Actuarial gains and losses are recognized in profit or loss in the period in which they occur.

2.26.4 Benefits in respect of the termination of employment

Severance pay for employees is reflected as an expense when the Group has made an undertaking, with no real possibility of cancellation, for the dismissal of employees before they reach the customary retirement age in accordance with a detailed formal plan. The benefits that are given to the employees who take voluntary retirement when the Group has offered the employees a plan that encourages voluntary retirement, it is expected that the offer will be accepted and the number of persons accepting the offer can be reliably estimated.

2.27 Significant accounting judgments and estimates used in the preparation of the financial statements

2.27.1 Judgments

In the process of applying the significant accounting policies, the Group has exercised its judgment and has taken into account matters which have the most significant impact on the amounts that have been recognized in the consolidated financial statements.

2.27.2 Estimates and assumptions

The preparation of the consolidated financial statements requires the Group to make estimates and assumptions that have an effect on the application of the accounting policies and on the reported amounts of assets, liabilities, revenues and expenses. These estimates and underlying assumptions are reviewed regularly. Changes in accounting estimates are reported in the period in which the estimate changes.

2.27.3 Impairment of goodwill

Determining whether goodwill is impaired requires an estimation of the value in use of the cash-generating units to which goodwill has been allocated. The value in use calculation requires the Managers to estimate the future cash flows expected to arise from the cash-generating unit and a suitable discount rate in order to calculate present value. Where the actual future cash flows are less than expected, a material impairment loss may arise.

2—Significant accounting policies (Continued)

The value in use of each CGU was determined by estimating cash flows for a period of five years for the operating activities. Cash flow forecasts are derived from the most recent business plans approved by the Board of Managers. Beyond the specifically forecasted period of five years, the Company extrapolates cash flows for the remaining years based on an estimated constant growth rate between 1.5-2%. This rate does not exceed the average long-term growth rate for the relevant markets. Discount rates have been computed using WACC approach and range from 6.3% to 11%.

2.27.4 Legal claims

In estimating the likelihood of outcome of legal claims filed against the Group and its investees, the Group companies rely on the opinion of their legal counsel. These estimates are based on the legal counsel's best professional judgment, taking into account the stage of proceedings and historical legal precedents in respect of the different issues. Since the outcome of the claims will be determined in courts, the results could differ from these estimates.

2.27.5 Post-employment benefits

The liability in respect of post-employment defined benefit plans is determined using actuarial valuations. The actuarial valuation involves making assumptions about, among others, discount rates, expected rates of return on assets, future salary increases and mortality rates. Due to the long-term nature of these plans, such estimates are subject to uncertainty.

2.27.6 Deferred tax asset

Deferred tax assets relate primarily to tax loss carry forwards and to deductible temporary differences between reported amounts and the tax bases of assets and liabilities. The assets relating to the tax loss carry forwards are recognized if it is probable that the Group will generate future taxable profits against which these tax losses can be set off. Evaluation of the Group's capacity to utilize tax loss carry-forwards relies on significant judgment. The Group analyses past events, and the positive and negative elements of certain economic factors that may affect its business in the foreseeable future to determine the probability of its future utilization of these tax loss carry forwards.

2.27.7 Discounting of Yield Free Preferred Equity Certificates and similar instruments (YFPEC)

The Group has loans with its equity holder which are currently non-interest bearing and therefore considered as not being at arm's length. In determining the present value, a discount rate of 4.76% has been used for YFPECs and a discount rate of 6.79% for the Interest Free Loans (IFLs) issued by the Group.

Altice VII S.à r.l.

Consolidated financial statements as of December 31, 2013 (Continued)

3—Scope of consolidation

3.1 The entities included in the scope of consolidation

Name of subsidiary	Place of incorporation and operation	Method of consolidation		Proportion of ownership interest and voting power held by the group	
		December 31, 2013	December 31, 2012	December 31, 2013	December 31, 2012
Altice VII S.à r.l.	Luxembourg	Parent company	Parent company	—	—
Cool Holding LTD	Israel	FC(*)	FC(*)	100%	100%
H. Hadaros 2012 LTD	Israel	FC(*)	FC(*)	100%	100%
HOT Telecommunication Systems LTD	Israel	FC(*)	FC(*)	100%	100%
Hot Telecom Limited Partnership	Israel	FC(*)	FC(*)	100%	100%
Hot Mobile LTD	Israel	FC(*)	FC(*)	100%	100%
Hot Cable Telecommunications Systems LTD	Israel	FC(*)	FC(*)	100%	100%
Hot Net Internet Services LTD (Formerly Hot Investments and Finance LTD)	Israel	FC(*)	FC(*)	100%	100%
Hot Vision LTD	Israel	FC(*)	FC(*)	100%	100%
Nonstop Ventures LTD	Israel	Equity method	Equity method	50%	50%
South Saron Communications LTD	Israel	FC(*)	FC(*)	100%	100%
Iscarable LTD	Israel	FC(*)	FC(*)	100%	100%
Hot TLM Subscription Television LTD	Israel	FC(*)	FC(*)	100%	100%
Hot Eden Cables Systems LTD	Israel	FC(*)	FC(*)	100%	100%
Hot Israel Cables Systems LTD	Israel	FC(*)	FC(*)	100%	100%
Hot Net Limited Partnership	Israel	FC(*)	FC(*)	100%	100%
Hot EDOM LTD	Israel	FC(*)	FC(*)	100%	100%
Zira (Copyrights on the Internet) LTD	Israel	Equity method	Equity method	25%	25%
Altice Securities S.à r.l.	Luxembourg	FC(*)	FC(*)	100%	100%
Altice Holdings S.à r.l.	Luxembourg	FC(*)	FC(*)	100%	—
Altice Africa S.à r.l.	Luxembourg	FC(*)	FC(*)	100%	100%
Altice Blue One S.A.S.	France	FC(*)	FC(*)	100%	100%
MTVC S.A.	France	FC(*)	FC(*)	76.97%	100%
WSG S.A.	France	FC(*)	FC(*)	76.97%	99.95%
Green.ch	Switzerland	FC(*)	FC(*)	99.12%	99.12%
Valvision S.A.S.	France	—	FC(*)	—	100%
Auberimmo S.A.S.	France	FC(*)	FC(*)	100%	100%
Green Datacenter AG	Switzerland	FC(*)	FC(*)	97,3%	97%
Deficom Telecom S.à r.l.	Luxembourg	FC(*)	FC(*)	74%	74%
Coditel Holding Lux II S.à r.l.	Luxembourg	FC(*)	FC(*)	84.4%	44.39%
Coditel Holding Lux S.à r.l.	Luxembourg	FC(*)	FC(*)	84.4%	44.39%
Coditel Holding S.A.	Luxembourg	FC(*)	FC(*)	84.4%	44.39%
Coditel Brabant S.p.r.l.	Belgium	FC(*)	FC(*)	84.4%	44.39%
Coditel S.à r.l.	Luxembourg	FC(*)	FC(*)	84.4%	44.39%
Coditel Management S.à r.l.	Luxembourg	FC(*)	FC(*)	84.4%	44.39%
Altice Caribbean S.à r.l.	Luxembourg	FC(*)	FC(*)	100%	100%
Altice Portugal S.A.	Portugal	FC(*)	FC(*)	100%	60%
Cabovisao S.A.	Portugal	FC(*)	FC(*)	100%	60%
Altice Finco S.A.	Luxembourg	FC(*)	FC(*)	100%	100%
Altice Financing S.A.	Luxembourg	FC(*)	FC(*)	100%	100%
Altice West Europe S.à r.l.	Luxembourg	FC(*)	—	100%	—
OMT Invest S.A.S	France	FC(*)	—	76.97%	—
Groupe Outremer Telecom S.A.	France	FC(*)	—	76.97%	—
Outremer Télécom S.A.S	France	FC(*)	—	76.97%	—
Outremer Télécom Océan Indien S.A.S	France	FC(*)	—	76.97%	—
Altice Blue Two S.A.S	France	FC(*)	—	76.97%	—
City Call Ltd	Mauritius	FC(*)	—	76.97%	—
Outremer Telecom Ltee	Mauritius	FC(*)	—	76.97%	—
Telecom Reunion SNC	France	FC(*)	—	76.97%	—
Telecom 2004 SNC	France	FC(*)	—	76.97%	—

Altice VII S.à r.l.

Consolidated financial statements as of December 31, 2013 (Continued)

3—Scope of consolidation (Continued)

Name of subsidiary	Place of incorporation and operation	Method of consolidation		Proportion of ownership interest and voting power held by the group	
		December 31, 2013	December 31, 2012	December 31, 2013	December 31, 2012
		OPS S.A.S	France	FC ^(*)	—
WLL Antilles-Guyane S.A.S . . .	France	FC ^(*)	—	76.97%	—
WLL Réunion SAS	France	FC ^(*)	—	76.97%	—
ONI S.G.P.S., S.A.	Portugal	FC ^(*)	—	100%	—
Winreason S.A.	Portugal	FC ^(*)	—	100%	—
Onitelecom-Infomunicações, S.A.,	Portugal	FC ^(*)	—	100%	—
Knewon S.A.	Portugal	FC ^(*)	—	100%	—
Onitelecom Açores S.A.	Portugal	FC ^(*)	—	100%	—
Onitelecom Madeira S.A.	Portugal	FC ^(*)	—	100%	—
Altice Content S.à r.l.	Luxembourg	FC ^(*)	—	100%	—
Ma Chaîne Sport S.A.S.	France	FC ^(*)	—	100%	—
Sport Lux S.à r.l.	Luxembourg	FC ^(*)	—	100%	—
Sportv S.A.	Luxembourg	FC ^(*)	—	100%	—
CPA Lux S.à r.l.	Luxembourg	FC ^(*)	—	100%	—
Altice Bahamas S.à r.l.	Luxembourg	FC ^(*)	—	100%	—

(*) FC stands for “Full Consolidation”

3.1.1 Composition of the Group

Principal activity	Place of incorporation and operation	Number of wholly owned subsidiaries	
		31/12/2013	31/12/2012
Distribution of cable based telecommunication services	Israel	9	9
	Belgium	1	1
	Luxembourg	1	1
	Portugal	5	1
	France	3	2
Provider of mobile services	France	2	—
	Israel	1	1
Production and distribution of content based services	Israel	1	1
	France	1	—
	Luxembourg	1	—
Total		25	16

3.2.2 Details of non-wholly owned subsidiaries that have material non-controlling interests

Name of subsidiary	Place of incorporation and operation	Proportion of ownership interests and voting rights held by non-controlling interests		Profit/ (loss) allocated to non-controlling interests		Accumulated non-controlling interests	
		December 31, 2013	December 31, 2012	December 31, 2013	December 31, 2012	December 31, 2013	December 31, 2012
		Altice Blue Two S.A.S	France	23%	—	(2.7)	—
Deficom Telecom S.à r.l.	Luxembourg	26%	26%	(17.1)	(10.6)	(9.3)	(13.5)
Green.ch	Switzerland	0.88%	0.88%	—	—	0.3	0.4
Green Datacenter AG	Switzerland	3%	3%	—	—	0.2	0.2
Cool Holding	Israel	—	—	—	(39.4)	9.3	9.1
Winreason S.A.	Portugal	—	—	—	—	0.4	—
Altice Portugal S.A.	Portugal	—	40%	(2.3)	9.1	—	9.1
Total				(22.1)	(40.9)	(0.5)	5.2

3—Scope of consolidation (Continued)

3.2 Modification of the scope of consolidation

3.2.1 Main acquisitions in 2013

3.2.1.1 Acquisition of OMT

On July 5, 2013 the Group obtained control of OMT, a telecommunications operator in the French Overseas Territories, by acquiring 77% of the shares and voting interests in the company. This acquisition enables the Group to expand its footprint in the French Overseas Territories.

Since July 5, 2013 OMT contributed €102.1 million to revenue and €13.5 million to operating profit to the Group's results for the year ended December 31, 2013.

A purchase price allocation was performed following the acquisition of OMT based on the assumptions described below.

Brand:

The ONLY brand was valued using the royalty relief method over an indefinite useful life and the method was built on the following assumptions :

- Discount rate—11.4%
- Royalty rate—1.5%

Clients:

The portfolio of clients has been valued using the excess earnings approach and based upon the following assumption:

- EBIT margin rate: 13.5% for fixed telephone clients, 12.4% for internet clients, 19.3% for mobile clients, 26.4% for B2B clients.
- Attrition rate: 9.7% for fixed telephone clients, 29.2% for internet clients, 48.5% for mobile clients, 16.4% for B2B clients.
- Discount rate: 11.4%
- Perpetuity growth rate: 2%

3.2.1.2 Acquisition of ONI Communication

On August 8, 2013 the Group obtained control of ONI, a business to business telecommunications operator in Portugal, by acquiring 100% of the shares and voting interests in the company. This acquisition enables the Group to expand its footprint in Portugal and eventually realise synergies with the Group's other business within the same country.

Since August 8, 2013 ONI contributed €41.8 million in revenue and €4.9 million in operating loss to the Group's result for the year ended December 31, 2013.

A purchase price allocation was performed following the acquisition of ONI based on the assumptions described below.

Brand:

The ONI brand was valued using the royalty relief method over an indefinite useful life and the method was built on the following assumptions :

- Discount rate—6.5%;
- Royalty rate—2.0%.

Altice VII S.à r.l.
Consolidated financial statements as of December 31, 2013 (Continued)

3—Scope of consolidation (Continued)

Clients:

The portfolio of clients has been valued using the excess earnings approach and based upon the following assumptions :

- EBIT margin rate: 14.1%;
- Attrition rate: 22.9% for B2B clients;
- Discount rate: 6.5%;
- Perpetuity growth rate: 0%.

3.2.1.3 Integration of content channels

On October 4, 2013 Ma Chaine Sport S.A.S. (“MCS”) and SportV S.A. (“SportV”), two exclusive content producing companies based in France and Luxembourg respectively were transferred to the Group by Altice IV and Valemi Corp, Altice IV S.A. being considered as a related party as it shares the same controlling shareholder as the Group at time of acquisition. In the absence of any specific guidance concerning the accounting for common control transactions within IFRS, no purchase price allocation was performed. These transactions allow the group to pursue a strategy of vertical integration and also provide a more integrated solution to its customers.

Since October 4, 2013, Ma Chaine Sport and SportV contributed €6.4 million in revenue and €0.3 million in operating profit to the Group’s result for the year ended December 31, 2013.

3.2.2 Change in the Group’s ownership interest in 2013

3.2.2.1 Acquisition of minority interests in Cabovisao

On April 23, 2013, the Company completed the acquisition of 40% of minority stake held by Apax Partners in its Portuguese subsidiary Cabovisao S.A, through an investment in the holding company of Cabovisao S.A, Altice Portugal.

The total consideration of EUR 105.0 million was paid on April 23, 2013, of which EUR 90.0 million was paid in consideration for the shares acquired and EUR 15.0 million towards the repayment of an existing vendor note. An amount of EUR 9.1 million (being the proportionate share of the carrying amount of the net assets of the entity) has been transferred between non-controlling interests to controlling interest. The difference of EUR 80.9 million between the decrease in the non-controlling interests and the consideration received has been debited from the retained earnings.

3.2.2.2 Disposal of Valvision

On June 6, 2013, the Company disposed of its interests in Valvision S.A.S, a cable based service provider in France to Altice VII Bis S.à r.l., a sister concern under common control of the Company’s sole shareholder, Next L.P.

The difference of EUR 3.3 million gain generated on this transaction (representing the difference between the net asset value of the entity prior to transfer and the consideration received) has been recognized directly in equity.

3.2.2.3 Acquisition of minority interests in Coditel

Deficom Telecom S.à r.l., a majority owned subsidiary of Altice VII, is the owner of 60% of the outstanding shares of Coditel Holding Lux II and Coditel Management. On November 29, 2013, Altice Holdings S.à r.l. purchase 40% of the interest of Coditel Holding Lux II and Coditel Management held by Codilink S.à r.l. .

The total consideration of EUR 82.5 million was paid on November 29, 2013, of which EUR 30.6 million was paid in consideration for shares and EUR 51.9 million paid as repayment of subordinated debt instruments held by Codilink (the Coditel PECs). An amount of EUR (9.3) million (being the proportionate

Altice VII S.à r.l.

Consolidated financial statements as of December 31, 2013 (Continued)

3—Scope of consolidation (Continued)

share of the carrying amount of the net assets of the entity) has been transferred from non-controlling interests to controlling interest. The difference of EUR 39.9 million between the decrease in the non-controlling interests and the consideration received has been debited from the retained earnings.

3.3 Acquisitions of businesses

Business combinations that occurred during the reporting period are described in note 3.2.

The major classes of assets acquired and liabilities assumed at the acquisition date are:

	Total Business Combinations	OMT	ONI	MCS ⁽¹⁾	SportV ⁽¹⁾
	(in millions of euros)				
Cost of acquisition ⁽²⁾	280.6	223.3	22.3	23.0	12.0
ASSET					
Intangible assets	154.1	106.7	45.9	1.3	0.2
Property, plant and equipment	122.9	69.5	52.6	0.9	—
Non-current financial assets	1.6	1.6	—	—	—
Inventories	6.3	4.9	1.4	—	—
Trade accounts receivable and other	55.7	28.1	19.6	6.0	2.0
Tax receivable	3.0	2.6	0.4	—	—
Cash and cash equivalents	36.3	33.6	0.7	0.3	1.7
Other current assets	13.0	3.2	8.7	0.6	0.5
Total assets	393.0	250.2	129.3	9.1	4.4
EQUITY AND LIABILITIES					
Non-current liabilities	253.1	205.3	47.5	0.3	—
Current liabilities	185.7	115.5	60.8	6.7	2.7
Total liabilities	438.8	320.8	108.3	7.0	2.7
Net assets	(45.9)	(70.6)	21.0	2.1	1.7
Residual goodwill	295.2	293.9	1.3	—	—
<i>Including impact of non-controlling interests on goodwill</i>	67.7	67.7	—	—	—

(1) No goodwill is attributed to neither MCS nor SportV as these were deemed by the Board of Managers to be integrations under common control and thus any difference in the net asset value and the purchase price is recorded directly in the reserves of the group attributable to the shareholders. See note 13 for more details.

(2) When acquiring OMT, ONI and MCS and Sport, the company did not, (i) pay the vendors of OMT and ONI directly as the cash was transferred directly from the lenders to the sellers' accounts, or to their debt holders in case of refinancing of the acquired entities debts or (ii) did not pay the entire amount in cash (as was the case for MCS and SportV), thus generating vendor notes held by the vendors. The total cash out from the accounts of the company amounted to EUR 13.0 million. These vendor notes were settled in 2014.

The acquisition of a controlling stake in OMT Invest S.A.S ("OMT") and Winreason S.A. ("ONI") are considered to be non-cash transactions, as the consideration paid to the vendors flows directly from the lending parties to final sellers, without transitioning through the company's accounts. Thus, the cost of such transactions is deducted directly from the issuance of debt in the consolidated statement of cash flows.

Altice VII S.à r.l.

Consolidated financial statements as of December 31, 2013 (Continued)

3—Scope of consolidation (Continued)

The main figures of the entity, since the beginning of the year, and until the business combination, are presented as follows:

	<u>OMT</u>	<u>ONI</u>	<u>MCS</u>	<u>SportV</u>
	(in millions of euros)			
Revenues	96.5	59.0	13.8	4.5
Cost of sales	(30.1)	(31.2)	(3.4)	(1.1)
Gross Profit	66.4	27.8	10.5	3.3
Other operating expenses	(19.8)	(11.2)	(1.4)	—
General and administrative expenses	(6.1)	(5.9)	(1.1)	(0.1)
Other sales and marketing expenses	(7.3)	(1.3)	(0.2)	(0.2)
Operating profit before depreciation, amortization and non-recurring costs	33.2	9.4	7.7	3.0
Depreciation and amortization	(11.4)	(9.9)	(6.2)	(1.1)
Other (expenses)/income, net	(2.0)	(1.7)	(0.5)	—
Management fees	—	—	—	—
Reorganization and non-recurring costs	(0.4)	(0.5)	—	—
Operating profit	19.4	(2.7)	1.0	1.9
Profit / (loss) for the period (including non-controlling interests) .	10.9	(8.8)	0.8	1.4

Altice VII S.à r.l.

Consolidated financial statements as of December 31, 2013 (Continued)

4—Goodwill

The Company identified six operating segments. As a result, goodwill acquired in business combinations was allocated to these operating segments based on the relative fair values of the operating segments. Goodwill is allocated as follows to each of the Company's operating segments:

	December 31, 2012	Business combinations	Impairment losses	Changes in foreign currency translation	Disposals	December 31, 2013
	(in millions of euros)					
WSG	4.6	—	—	—	—	4.6
Valvision	1.4	—	—	—	(1.4)	(0.0)
Green ch	17.8	—	—	—	—	17.8
Coditel	295.5	—	—	—	—	295.5
Hot Telecom	601.8	—	—	18.4	—	620.2
OMT Invest	—	293.9	—	—	—	293.9
ONI	—	1.3	—	—	—	1.3
Total Gross Value . . .	921.1	295.2	—	18.5	(1.4)	1,233.3
WSG	(4.6)	—	—	—	—	(4.6)
Valvision	(1.4)	—	—	—	1.4	—
Green ch	—	—	—	—	—	—
Coditel	—	—	—	—	—	—
Hot Telecom	(124.2)	—	—	(3.8)	—	(128.0)
OMT Invest	—	—	—	—	—	—
ONI	—	—	—	—	—	—
Total Cumulative impairment	(130.1)	—	—	(3.8)	1.4	(132.6)
WSG	(0.0)	—	—	—	—	(0.0)
Valvision	(0.0)	—	—	—	—	(0.0)
Green ch	17.8	—	—	—	—	17.8
Coditel	295.4	—	—	—	—	295.5
Hot Telecom	477.6	—	—	14.7	—	492.2
OMT Invest	—	293.9	—	—	—	293.9
ONI	—	1.3	—	—	—	1.3
Total Net book value .	790.9	295.2	—	14.6	—	1,100.7

Altice VII S.à r.l.
Consolidated financial statements as of December 31, 2013 (Continued)

4—Goodwill (Continued)

	December 31, 2011	Business combinations	Impairment losses	Changes in foreign currency translation	December 31, 2012
	(in millions of euros)				
WSG	4.6	—	—	—	4.6
Valvision	1.4	—	—	—	1.4
Green ch	17.8	—	—	—	17.8
Coditel Brabant	209.2	—	—	—	209.2
Coditel S.à r.l.	86.3	—	—	—	86.3
Hot Telecom	600.2	—	—	1.6	601.8
Total Gross Value	919.5	—	—	1.6	921.1
WSG	(4.6)	—	—	—	(4.6)
Valvision	(1.4)	—	—	—	(1.4)
Green ch	—	—	—	—	—
Coditel Brabant	—	—	—	—	—
Coditel S.à r.l.	—	—	—	—	—
Hot Telecom	(1.6)	—	(121.9)	(0.7)	(124.2)
Total Cumulative impairment . . .	(7.6)	—	(121.9)	(0.7)	(130.2)
WSG	—	—	—	—	—
Valvision	—	—	—	—	—
Green ch	17.8	—	—	—	17.8
Coditel Brabant	209.2	—	—	—	209.2
Coditel S.à r.l.	86.3	—	—	—	86.3
Hot Telecom	598.6	—	(121.9)	0.9	477.6
Total Net book value	911.9	—	(121.9)	0.9	790.9

The carrying amount of goodwill as at December 31, 2013 was EUR 1,100.7 million (December 31, 2012 was EUR 790.9 million).

Goodwill is reviewed at the Group of cash-generating unit (“CGU”) level for impairment annually and whenever changes in circumstances indicate that its carrying amount may not be recoverable. For 2013, goodwill was tested at the CGU level for impairment as of December 31. The CGU is at the subsidiary level of the Company. The recoverable amounts of the CGUs are determined based on their value in use. The Company determined to calculate value in use for purposes of its impairment testing and, accordingly, did not determine the fair value of the CGUs as the carrying value of the CGUs was lower than their value in use. The key assumptions for the value in use calculations are primarily the pre-tax discount rates, the terminal growth rate and the churn rate. The impairment tests did not result in impairment for any periods presented in these consolidated financial statements, except for EUR 121.9 million in Hot Telecom for the year ended December 31, 2012.

The value in use of the CGUs was determined by estimating cash flows for a period of five years, giving due consideration to the nature of the industry in which each CGU operates. Assumptions for churn rates and EBIT margin were based on historical experience and expectations of future changes in the market. Cash flow forecasts were derived from the most recent financial plans approved by management.

Beyond the specifically forecasted period of five years, the Company extrapolated cash flows for the remaining years based on an estimated constant growth rate between 1% and 2%. These rates did not exceed the average long-term growth rate for the relevant markets.

When estimating turnover for purposes of the 2013 impairment test, the Company used a growth rate between (3.6)-6% over the next 5 years. Those estimates were determined on the basis of the analysis of

Altice VII S.à r.l.

Consolidated financial statements as of December 31, 2013 (Continued)

4—Goodwill (Continued)

the markets where the Company is active in as well as on the basis of projections provided by external sources.

	<u>Green. ch</u>	<u>Coditel</u>	<u>Hot Telecom</u>
Average long term growth rate in 2012 (in %)	2.0	2.0	1.5-2
Average long term growth rate in 2103 (in %)	2.0	2.0	2.0

When estimating EBIT margin for purposes of the 2013 impairment test, the Company used a stable ratio of EBIT margin over the next 5 years.

Management estimated discount rates using post-tax rates that reflected current market rates for investments of similar risk. The discount rate for the CGUs was estimated from the weighted average cost of capital (“WACC”) of companies which operate a portfolio of assets similar to those of the Company’s assets.

	<u>Green ch</u>	<u>Coditel</u>	<u>Cabovisao</u>	<u>Hot Telecom</u>
CGU weighted average post-tax WACC rate used in 2012 (in %)	7.0	8.0-8.5	—	10-11
CGU weighted average pre-tax WACC rate used in 2013 (in %)	6.5	6.6	6.3	10-11

The results of the goodwill impairment test of 2012 and 2013 for each CGU did not result in an impairment of goodwill as the value in use exceeded the carrying value of the CGU, except for EUR 121.9 million in Hot Telecom for the year ended December 31, 2012.

In validating the value in use determined for the CGU for the year ended December 31, 2013, key assumptions used in the discounted cash-flow model were sensitized to test the resilience of value in use and no impairments were noted in these sensitivity analysis.

	<u>Green.ch</u>	<u>Coditel</u>	<u>Hot Telecom</u>
Recoverable amount	124.4	466.6	1,357.1
Carrying amount	<u>17.8</u>	<u>295.5</u>	<u>477.6</u>
Excess of recoverable amount over carrying amount	<u>106.6</u>	<u>171.1</u>	<u>879.5</u>

The following changes in key assumptions in projected cash flows in every year of the initial five-year period, assuming unchanged values for the other assumptions, would cause the recoverable amount to equal the respective carrying value;

In addition, the Company analyzed the sensitivity of the estimated recoverable amounts to the reasonable expected changes in assumptions, assuming unchanged values for the other assumptions:

- Sensitivity of the recoverable amount was tested for a movement of 50 bps in the weighted average cost of capital (WACC), all other assumptions being stable and the impact would be :
 - Green.ch: an increase of 50 bps in the WACC decreases the excess of recoverable amount to EUR 90.2 million and therefore no impairment is required.
 - Coditel: an increase of 50 bps in the WACC decreases the excess of recoverable amount to EUR 103.9 million and therefore no impairment would be required.
 - HOT Mobile: an increase of 50 bps in the WACC decreases the recoverable amount to EUR 807.2 million and therefore no impairment would be required.
- Sensitivity of the recoverable amount was tested for a movement of 50 bps in the perpetuity growth rates, all other assumptions being stable and the impact would be :
 - Green.ch: an increase of 50 bps in the perpetuity growth rate decreases the excess of recoverable amount to EUR 93 million and therefore no impairment would be required.

Altice VII S.à r.l.

Consolidated financial statements as of December 31, 2013 (Continued)

4—Goodwill (Continued)

- Coditel: an increase of 50 bps in the perpetuity growth rate decreases the excess of recoverable amount to EUR 66.1 million and therefore no impairment would be required.
- HOT Mobile: an increase of 50 bps in the perpetuity growth rate decreases the recoverable amount to EUR 825.1 million and therefore no impairment would be required.

The analysis did not result in a scenario whereby a reasonable possible change in the aforementioned key assumptions would result in a recoverable amount for the CGU which is inferior to the carrying value.

5—Intangible assets

	December 31, 2012	Additions and related depreciation and amortization	Disposals	Business Combinations	Changes in foreign currency translation adjustment	Other	December 31, 2013
	(in millions of euros)						
Software	64.9	23.5	—	—	3.0	0.1	91.2
Brand name	79.8	0.3	—	49.1	0.7	—	129.9
Customer relations ⁽¹⁾ . .	325.6	—	—	52.9	8.2	—	386.7
Licenses	31.9	6.2	—	14.7	0.5	3.6	56.8
R&D costs acquisitions	—	—	—	1.8	—	2.1	3.8
Subscriber purchase costs ⁽²⁾	173.9	20.2	—	—	6.2	—	200.3
Intangible assets under construction	—	5.2	(0.5)	7.7	—	(5.9)	6.5
Other intangible assets	118.9	37.1	(0.7)	28.0	2.5	0.5	186.3
Total Gross Value . . .	795.0	92.5	(1.2)	154.1	21.1	0.5	1,061.9
Software	(28.1)	(25.4)	—	—	(1.9)	(0.1)	(55.5)
Brand name	(2.6)	(2.2)	—	—	(0.2)	—	(5.0)
Customer relations ⁽¹⁾ . .	(52.9)	(36.1)	—	—	(2.5)	—	(91.5)
Licenses	(9.9)	(7.3)	—	—	(0.1)	0.1	(17.2)
R&D costs	—	(0.7)	—	—	—	—	(0.7)
Subscriber purchase costs ⁽²⁾	(166.3)	(21.8)	—	—	(6.0)	—	(194.1)
Intangible assets under construction	—	—	—	—	—	—	—
Other intangible assets	(76.7)	(40.7)	0.7	—	(1.6)	—	(118.3)
Total Cumulative amortization and depreciation	(336.5)	(134.1)	0.7	—	(12.3)	—	(482.3)
Software	36.8	(1.9)	—	—	1.1	—	.36
Brand name	77.2	(1.9)	—	49.1	0.5	—	124.9
Customer relations ⁽¹⁾ . .	272.7	(36.1)	—	52.9	5.8	—	295.3
Licenses	22.0	(1.1)	—	14.7	0.4	3.8	39.7
R&D costs	—	(0.7)	—	1.8	—	2.1	3.1
Subscriber purchase costs ⁽²⁾	7.6	(1.6)	—	—	0.2	—	6.2
Intangible assets under construction	—	5.2	(0.5)	7.7	—	(5.9)	6.5
Other intangible assets	42.2	(3.6)	—	28.0	0.9	0.5	68.0
Total Net book value .	458.5	(41.7)	(0.5)	154.1	8.7	0.5	579.6

Altice VII S.à r.l.

Consolidated financial statements as of December 31, 2013 (Continued)

5—Intangible assets (Continued)

	December 31, 2011	Additions and related depreciation and amortization	Disposals	Business Combinations	Changes in foreign currency translation adjustment	Other	December 31, 2012
	(in millions of euros)						
Software	37.1	27.3	—	—	0.3	0.1	64.9
Brand name	50.0	—	—	29.6	0.2	—	79.8
Customer relations ⁽¹⁾ . .	316.4	—	—	8.2	1.0	—	325.6
Licenses	19.2	13.2	(0.6)	—	—	0.1	31.9
Subscriber purchase costs ⁽²⁾	152.1	21.2	—	—	0.6	—	173.9
Intangible assets under construction	—	0.3	—	—	—	(0.3)	—
Other intangible assets	95.3	23.1	—	0.1	0.4	—	118.9
Total Gross Value . . .	670.3	85.1	(0.6)	37.9	2.5	(0.1)	795.0
Software	(10.8)	(17.2)	0.2	—	(0.2)	(0.1)	(28.1)
Brand name	(1.1)	(1.5)	—	—	—	—	(2.6)
Customer relations ⁽¹⁾ . .	(21.6)	(31)	—	—	(0.3)	—	(52.9)
Licenses	(7.1)	(2.9)	0.2	—	—	(0.1)	(9.9)
Subscriber purchase costs ⁽²⁾	(140.4)	(25.3)	—	—	(0.6)	—	(166.3)
Intangible assets under construction	—	—	—	—	—	—	—
Other intangible assets	(30.9)	(46.1)	—	—	(0.3)	0.6	(76.7)
Total Cumulative amortization and depreciation	(211.9)	(124.0)	(0.4)	0.0	(1.4)	0.4	(336.5)
Software	26.3	10.1	0.2	—	0.1	—	36.8
Brand name	48.9	(1.5)	—	29.6	0.2	—	77.2
Customer relations ⁽¹⁾ . .	294.8	(31.0)	—	8.2	0.7	—	272.7
Licenses	12.1	10.3	(0.4)	—	—	—	22.0
Subscriber purchase costs ⁽²⁾	11.7	(4.1)	—	—	—	—	7.6
Intangible assets under construction	—	0.3	—	—	—	(0.3)	—
Other intangible assets	64.4	(23.0)	—	0.1	0.1	0.6	42.2
Total Net book value .	458.3	(38.9)	(0.2)	37.9	1.1	0.3	458.5

(1) Customer relations have been valued on the basis of the fair value of the existing customers. These are amortized on the basis of the local churn rate.

(2) Subscriber purchase costs were recognized in respect of the costs of acquisition of subscribers (including additional sales commissions). The amortization expenses are linked to the length of the average commitment of the subscribers.

Altice VII S.à r.l.

Consolidated financial statements as of December 31, 2013 (Continued)

6—Property, Plant & Equipment

	December 31, 2012	Additions and related depreciation and amortization	Disposals	Business Combinations	Changes in foreign currency translation adjustment	Other	December 31, 2013
	(in millions of euros)						
Land	2.9	0.2	—	0.2	—	—	3.3
Buildings	68.6	8.7	—	5.6	1.4	2.5	86.8
Cable networks ⁽¹⁾	661.8	58.8	(0.2)	0.7	31.8	1.1	754.0
Call center (primarily electronic equipment) ⁽²⁾	94.8	16.1	(0.4)	1.0	7.5	0.1	119.1
Converters and modems	230.5	26.3	(1.0)	2.9	14.8	2.0	275.5
Computers and ancillary equipment	39.5	3.1	(0.1)	0.8	2.0	—	45.3
Office furniture and equipment ⁽³⁾	110.7	17.1	(19.2)	1.0	(0.5)	1.3	110.4
Communication network infrastructure ⁽⁴⁾	361.7	41.5	(3.6)	89.2	9.7	25.0	523.5
Other data center equipment	2.0	0.7	—	—	(0.0)	0.6	3.3
Tangible assets under construction	17.0	19.9	—	19.9	0.0	(31.6)	25.2
Prepayments on tangible assets	3.1	0.3	—	0.7	(0.0)	(4.1)	—
Other tangible assets	9.5	4.0	(0.1)	1.0	0.5	0.6	15.5
Total Gross Value	1,602.1	196.7	(24.6)	123.0	67.2	(2.5)	1,961.9
Buildings	(12.9)	(9.0)	—	—	(0.7)	—	(22.6)
Cable networks ⁽¹⁾	(136.4)	(112.1)	0.2	—	(18.5)	—	(266.8)
Call center (primarily electronic equipment) ⁽²⁾	(26.7)	(25.6)	—	—	(5.5)	—	(57.8)
Converters and modems	(50.5)	(50.3)	0.6	—	(9.3)	0.2	(109.3)
Computers and ancillary equipment	(27.6)	(5.4)	0.1	—	(1.8)	—	(34.7)
Office furniture and equipment ⁽³⁾	(37.0)	(14.1)	15.2	—	0.1	—	(35.8)
Communication network infrastructure ⁽⁴⁾	(235.0)	(46.2)	3.6	—	(5.9)	(0.5)	(284.0)
Other data center equipment	(1.4)	(0.4)	—	—	—	—	(1.8)
Tangible assets under construction	(0.3)	—	—	—	—	0.3	(0.1)
Prepayments on tangible assets	—	—	—	—	—	—	—
Other tangible assets	(6.4)	(8.0)	—	—	(0.5)	0.1	(14.8)
Total Cumulative amortization and depreciation	(534.3)	(271.1)	19.7	—	(42.1)	0.1	(827.7)
Land	2.9	0.2	—	0.2	—	—	3.3
Buildings	55.7	(0.3)	—	5.6	0.7	2.5	64.2
Cable networks ⁽¹⁾	525.4	(53.3)	—	0.7	13.3	1.1	487.2
Call center (primarily electronic equipment) ⁽²⁾	68.1	(9.5)	(0.4)	1.0	2.0	0.1	61.3
Converters and modems	180.0	(24.0)	(0.4)	2.9	5.5	2.2	166.2
Computers and ancillary equipment	11.9	(2.3)	—	0.8	0.2	—	10.6
Office furniture and equipment ⁽³⁾	73.7	3.0	(4.0)	1.0	(0.4)	1.3	74.6
Communication network infrastructure ⁽⁴⁾	126.7	(4.7)	—	89.2	3.8	24.5	239.5
Other data center equipment	0.6	0.3	—	—	—	0.6	1.5
Tangible assets under construction	16.6	19.9	—	19.9	—	(31.3)	25.1
Prepayments on tangible assets	3.1	0.3	—	0.7	—	(4.1)	0.0
Other tangible assets	3.1	(4.0)	(0.1)	1.0	—	0.7	(0.7)
Total Net book value	1,067.8	(74.4)	(4.9)	123.0	25.1	(2.4)	1,134.2

Altice VII S.à r.l.

Consolidated financial statements as of December 31, 2013 (Continued)

6—Property, Plant & Equipment (Continued)

	December 31, 2011	Additions and related depreciation and amortization	Disposals	Business Combinations	Changes in foreign currency translation adjustment	Other	December 31, 2012
	(in millions of euros)						
Land	2.6	—	—	0.3	—	—	2.9
Buildings	55.5	12.3	—	0.5	0.3	—	68.6
Cable networks ⁽¹⁾	480.3	58.3	(0.9)	110.4	3.0	10.7	661.8
Call center (primarily electronic equipment) ⁽²⁾	68.3	25.8	—	—	0.7	—	94.8
Converters and modems	161.8	70.4	(3.2)	—	1.5	—	230.5
Computers and ancillary equipment	29.1	6.4	—	0.1	0.2	3.7	39.5
Office furniture and equipment ⁽³⁾	97.7	12.2	(0.5)	0.7	0.2	0.4	110.7
Communication network infrastructure ⁽⁴⁾	301.9	58	(2.3)	3.1	1	—	361.7
Other data center equipment	3.0	—	(2.8)	—	—	1.8	2.0
Tangible assets under construction	7.2	19.8	(1.8)	8.4	—	(16.6)	17.0
Prepayments on tangible assets	0.1	3.0	—	—	—	—	3.1
Other tangible assets	6.2	3.2	—	0.1	—	—	9.5
Total Gross Value	1,213.7	269.4	(11.5)	123.6	6.9	0.0	1,602.1
Buildings	(8.7)	(4.0)	—	—	(0.2)	—	(12.9)
Cable networks ⁽¹⁾	(24.7)	(110.6)	0.8	—	(1.9)	—	(136.4)
Call center (primarily electronic equipment) ⁽²⁾	(5.8)	(19.6)	(0.8)	—	(0.5)	—	(26.7)
Converters and modems	(11)	(44.9)	6.3	—	(0.9)	—	(50.5)
Computers and ancillary equipment	(20.4)	(5.0)	(2.0)	—	(0.2)	—	(27.6)
Office furniture and equipment ⁽³⁾	(23.7)	(15.2)	1.9	—	—	—	(37.0)
Communication network infrastructure ⁽⁴⁾	(212.3)	(28.2)	6.0	—	(0.5)	—	(235.0)
Other data center equipment	(1.1)	(0.3)	—	—	—	—	(1.4)
Tangible assets under construction	(0.1)	(0.3)	—	—	—	—	(0.3)
Prepayments on tangible assets	—	—	—	—	—	—	—
Other tangible assets	(4.1)	(2.9)	0.6	—	—	—	(6.4)
Total Cumulative amortization and depreciation	(311.9)	(231.0)	12.8	—	(4.2)	—	(534.3)
Land	2.6	—	—	0.3	—	—	2.9
Buildings	46.8	8.3	—	0.5	0.1	—	55.7
Cable networks ⁽¹⁾	455.6	(52.3)	(0.1)	110.4	1.1	10.7	525.4
Call center (primarily electronic equipment) ⁽²⁾	62.6	6.2	(0.8)	—	0.2	—	68.1
Converters and modems	150.8	25.5	3.1	—	0.6	—	180.0
Computers and ancillary equipment	8.7	1.4	(2.0)	0.1	—	3.7	11.9
Office furniture and equipment ⁽³⁾	74	(3.0)	1.4	0.7	0.2	0.4	73.7
Communication network infrastructure ⁽⁴⁾	89.6	29.8	3.7	3.1	0.5	—	126.7
Other data center equipment	1.9	(0.3)	(2.8)	—	—	1.8	0.6
Tangible assets under construction	7.1	19.5	(1.8)	8.4	—	(16.6)	16.6
Prepayments on tangible assets	0.1	3.0	—	—	—	—	3.1
Other tangible assets	2.0	0.3	0.6	0.1	—	—	3.1
Total Net book value	901.8	38.4	1.3	123.6	2.7	0.0	1,067.8

(1) Cable network: the Group owns, directly and indirectly through its subsidiaries, cable or fibre network which allow it to supply cable-based pay television, broadband internet and fixed-line telephony services to its subscribers.

(2) Call center represents centralized offices used for the purpose of receiving or transmitting a large volume of administrative, technical or commercial requests by telephone.

Altice VII S.à r.l.

Consolidated financial statements as of December 31, 2013 (Continued)

6—Property, Plant & Equipment (Continued)

- (3) Office furniture and equipment refers to furnishings and IT equipment.
- (4) The Communication network infrastructure includes the digital technologies for the transmission of multi-channel television services.

The increase in the intangible and tangible assets of the group can mainly be attributed to the acquisition of Outremer Telecom and ONI Telecom during the course of 2013. These increases were slightly offset by the disposal of the Company's interests in Valvision.

7—Financial assets

	December 31, 2013	December 31, 2012
	(in millions of euros)	
Investments held as available for sale ⁽¹⁾	40.3	6.1
Loans and receivables ⁽²⁾	3.0	18.7
Other financial assets	5.5	—
Restricted cash ⁽³⁾	1.8	9.6
Total	50.6	34.4

- (1) Investment in available for sale financial assets are composed of:

Partner Communications LTD: A subsidiary company, operating through Hot Net Internet Services LTD. (formerly Hot Properties) and Finance LTD. (hereinafter-Hot Net) holds 1 454 663 regular shares in Partner Communications LTD, (hereinafter-Partner), constituting approximately 0,9% of Partner's share capital which is engaged in the provision of mobile communications services and whose shares are traded on stock exchanges in the United States of America, in the United Kingdom and in Israel.

Wananchi Group Holdings Ltd. In February 2013, the Company exercised its right to convert loans and receivables held against Wananchi Group Holdings Ltd. into shares. These notes were initially recorded as a long term trade receivable for the year ended December 31, 2012 and subsequently converted into equity in February 2013. The Board of Managers considers the investment in Wananchi to be available for sale investment and has injected further funds in Wananchi during the course of the year ended December 31, 2013. Wananchi operates in the fast developing East-African market and given the evolving nature of the business in this region, the Board of Managers considers that the nominal value of its investment in Wananchi represents the fair value of the investment. As of December 31, 2013, Altice VII held 17.05% of the capital of Wananchi and the Board of Managers is of the opinion that it has no significant influence on the Board of Wananchi.

- (2) As of December 31, 2013, this caption includes an additional investment made by the company in Wananchi, in return for which it was issued convertible notes, convertible at the discretion of the holder. The investment amounted to € 3.0 million (\$4 million equivalent). The decrease compared to December 31, 2012 is explained by the partial conversion of the notes from Wananchi to equity.
- (3) Restricted cash (see Note 2.21)

As of December 31, 2013 the restricted cash caption contained cash accounts pledged at Cabovisao, HOT and Green.ch held as guarantees to various financial institutions. The decrease in the amount of restricted cash compared to the year ended December 31, 2012, was mainly due to substitution of a guarantee given to Banco Esprito Santo by Cabovisao by an amount of EUR 8.4 million drawn from the Company's guarantee facility.

8—Non current Trade and other receivables

	December 31, 2013	December 31, 2012
	(in millions of euros)	
Prepaid expenses	0.6	0.8
Other receivables ⁽¹⁾	22.2	23.7
Total	22.8	24.6

- (1) The balance reflects customer's debts in respect of the sale of devices under long-term credit terms (sales in installments). The balance of the debt is presented at its value, as discounted using an interest rate of 5% for a period of up to 36 months, less the current maturities, which are presented under trade receivables.

Altice VII S.à r.l.

Consolidated financial statements as of December 31, 2013 (Continued)

9—Inventories

	December 31, 2013	December 31, 2012
	(in millions of euros)	
Work in progress	0.1	0.1
Finished/semi-finished goods	12.4	7.1
Total Gross Value	12.5	7.2
Work in progress	—	(0.1)
Finished/semi-finished goods	(1.5)	(1.0)
Total Depreciation	(1.5)	(1.1)
Work in progress	0.1	—
Finished/semi-finished goods	10.9	6.2
Total Net book value	11.0	6.1

Inventories are almost exclusively comprised finished goods corresponding to customer premises equipment (modems, decoders, mobile handsets etc.), which is used in the daily business activity of the Group. Management considers that inventory will be fully renewed in the next twelve months.

Movement for allowance for obsolescence of inventory or slow moving inventory:

	December 31, 2012	Business Combinations	Variation	Divestitures, changes in foreign currency translation adjustments and other	December 31, 2013
	(in millions of euros)				
Work in progress (goods)	(0.1)	—	0.1	—	—
Finished/semi-finished goods	(1.0)	—	(0.5)	—	(1.5)
Total Cumulative amortization and depreciation	(1.1)	—	(0.4)	—	(1.5)
	December 31, 2011	Business Combinations	Reversal	Divestitures, changes in foreign currency translation adjustments and other	December 31, 2012
	(in millions of euros)				
Work in progress (goods)	—	(0.1)	—	—	(0.1)
Finished/semi-finished goods	(1.9)	—	0.9	—	(1.0)
Total Cumulative amortization and depreciation	(1.9)	(0.1)	0.9	—	(1.1)

The cost of inventories recognised as an expense during the year in respect of continuing operations was EUR 0.4 million (31 December 2012: EUR 0.1 million).

The cost of inventories recognised as an expense includes EUR 0.4 million (2012: EUR 0.1 million) in respect of write-downs of inventory to net realisable value. This write down mainly concerns the write off of mobile handsets and accessories at OMT to reflect their net recoverable value.

Altice VII S.à r.l.

Consolidated financial statements as of December 31, 2013 (Continued)

10—Trade and other receivables

10.1 Trade receivables

	December 31, 2012	Business Combinations	Net increase/ (decrease)	Reversal	Divestitures, changes in foreign currency translation adjustments and other	December 31, 2013
	(in millions of euros)					
Trade receivables	175.6	50.0	(6.8)	—	5.5	224.3
Allowance for doubtful debts	(24.8)	—	(10.1)	7.0	(2.4)	(30.3)
Trade receivable, net	150.8	50.0	(16.9)	6.9	3.1	194.0

	December 31, 2011	Business Combinations	Net increase/ (decrease)	Reversal	Divestitures, changes in foreign currency translation adjustments and other	December 31, 2012
	(in millions of euros)					
Trade receivables	129.1	5.9	40.4	—	0.1	175.6
Allowance for doubtful debts	(26.4)	—	(3.0)	4.4	0.2	(24.8)
Trade receivable, net	102.7	5.9	37.4	4.4	0.3	150.8

The increase in trade receivables in the year ended December 31, 2013, as compared to the year ended December 31, 2012 is mainly explained by the acquisition of OMT, ONI, MCS and SportV during the course of the year.

10.2 Age of trade receivables

	December 31, 2013	December 31, 2012
	(in millions of euros)	
Not yet due	137.1	116.7
30 - 90 days	22.1	14.0
91 - 121 days	34.8	20.2
Total	194.0	150.8

10.3 Other receivables

	December 31, 2013	December 31, 2012
	(in millions of euros)	
Loans to related party	0.1	3.8
Bank guarantee ⁽¹⁾	—	14.0
Prepaid expenses ⁽²⁾	20.9	6.3
Other current receivables	15.9	8.2
Total	36.9	32.3

(1) Bank guarantees were provided to the Israeli regulator by HOT mobile in relation with the acquisition of the UMTS mobile license and then subsequently released after the occurrence of certain events. Please see note 22 for details on guarantees given by HOT and HOT mobile.

(2) The increase in prepaid expenses is mainly explained by the acquisition of ONI and the entry of MCS in the Group scope during the year ended December 31, 2013. The new entities contributed EUR 4.7 million and EUR 2.6 million to prepaid expenses and mainly concerned prepayments made on long term contracts.

Altice VII S.à r.l.

Consolidated financial statements as of December 31, 2013 (Continued)

10—Trade and other receivables (Continued)

The Group provides services on credit for an average of 16 days, 24 days and 96 days in average to its customers in the cable television field, the in-country fixed line communications field and the mobile communication field, respectively. The Group routinely evaluates the credit that is provided to its customers, while checking their financial situations; however it does not demand collateral for those debts. The Group records a provision for doubtful debts, based on the factors that affect the credit risks of certain customers, past experience and other information.

11—Cash and cash equivalents and current restricted cash

	December 31, 2013	December 31, 2012
	(in millions of euros)	
Term deposits	1.4	5.2
Bank overdraft	(0.3)	—
Bank balances	60.1	124.5
Cash and cash equivalents presented in the consolidated statement of cash flows	61.3	129.7
Restricted cash ⁽¹⁾	1,242.7	—
Restricted cash	1,242.7	—

(1) Current restricted cash refers to cash held in escrow accounts on behalf of Altice Finco and Altice Financing S.A., related to the acquisition of Orange Dominicana and Tricom. The Board of Managers expects the transactions to close in the first quarter of 2014, thus ensuring utilization of the cash in less than twelve months following December 31, 2013. As of the date of signing of these accounts, the Tricom acquisition had been successfully closed (See note 35).

12—Issued capital and share premium

On December 31, 2013, the share capital amounts to EUR 7.4 million and is divided into 743,011,510 fully paid shares with a nominal value of EUR 0.01.

	December 31, 2013	December 31, 2012
	(in millions of euros)	
Share capital	7.4	7.4
Share premium	5.4	—
Total	12.8	7.4

In June 2013, all the classes of shares were converted into one single class of shares with a nominal value of EUR 0.01 per share and equal voting rights. A capital increase amounting to EUR 4,500 took place on May 30, 2013 together with a share premium of EUR 1.8 million.

Share premium was also issued through the capitalization of a debt instrument for an amount of EUR 3.6 million.

Different classes of shares are summarized below:

	December 31, 2013	
Class of corporate units	Number	
Common shares	743,011,510	

Altice VII S.à r.l.
Consolidated financial statements as of December 31, 2013 (Continued)

12—Issued capital and share premium (Continued)

December 31, 2012	
Class of corporate units	Number
Class A	14,832,900
Class B	71,747,100
Class C	98,886,400
Class D	64,226,800
Class E	98,886,400
Class F	98,886,400
Class G	1,058,610
Class 1A	1,113,600
Class 1B	5,386,000
Class 1C	202,108,900
Class 1D	4,603,900
Class 1E	19,337,000
Class 1F	25,657,900
Class 1O	44,600
Class 1G	79,600
Class M	31,000,000
Class H	742,868
Class 1H	7,132
Ordinary	3,955,400
	December 31, 2013 December 31, 2012
	Number of shares
Opening balance	742,561,510 741,811,510
Issuance	450,000 750,000
Redemption	0 0
Closing balance	743,011,510 742,561,510

13—Other reserves

	December 31, 2013	December 31, 2012
	(in millions of euros)	
CPEC reserve	(2.2)	201.7
Discounting reserve	25.3	22.7
Employee Benefits Reserve	0.8	0.3
Currency Translation Reserve	(6.7)	(6.7)
Impact of changes in ownership interests	(71.5)	61.3
Integration of entities under common control	(31.2)	—
Other reserves	2.6	(1.6)
Group reserves	(82.9)	277.7

13.1 CPEC Reserves

CPECs (Convertible preferred equity certificates) issued by the group and subscribed by the direct shareholder Next L.P., whose maturity comprises between 2058 and 2061, increased from EUR 219.1 million in 2012 to EUR 290.5 that million in 2013, due to new issuances and subscriptions. In

Altice VII S.à r.l.

Consolidated financial statements as of December 31, 2013 (Continued)

13—Other reserves (Continued)

substance, CPECs are subordinated financial instruments have been considered as equity instruments as the issuer can avoid settling these in cash and the CPECs instruments does not bear interest.

Name	Maturity date	Interest rate	Convertible	Principal amount as at December 31, 2012	Principal amount as at December 31, 2013
CPECs A	14/05/2058	—	Yes (at the option of the issuer)	0.84	—
CPECs B	01/12/2058	—	Yes (at the option of the issuer)	3.61	—
CPECs B	14/05/2058	—	Yes (at the option of the issuer)	0.46	—
CPECs B	14/05/2058	—	Yes (at the option of the issuer)	15.42	—
CPECs C	03/12/2058	—	Yes (at the option of the issuer)	23.48	—
CPECs C	03/12/2058	—	Yes (at the option of the issuer)	22.67	—
CPECs C	14/05/2058	—	Yes (at the option of the issuer)	132.30	—
CPECs D	03/12/2058	—	Yes (at the option of the issuer)	3.45	—
CPECs E	01/12/2058	—	Yes (at the option of the issuer)	16.18	—
CPECs G	18/03/2058	—	Yes (at the option of the issuer)	0.06	—
CPECs H	29/06/2058	—	Yes (at the option of the issuer)	0.45	—
CPECs H	16/11/2060	—	Yes (at the option of the issuer)	0.01	—
CPECs H	01/12/2060	—	Yes (at the option of the issuer)	0.15	—
CPECs I	29/02/2061	—	Yes (at the option of the issuer)	0.03	—
Master CPECs	06/06/2062	—	Yes (at the option of the issuer)	—	290.5
Total				219.1	290.5

13.2 Discounting Reserves

The Master Yield Free Preferred Equity Certificates (“YFPEC”) have been valued using a discount rate of 4.76% given their preferred interest rate which therefore values these certificates at €4.8 million as of December 31, 2013. This value is recorded as a loan from related parties in the accounts of Altice VII.

The nominal amount of outstanding YFPECs issued by Altice VII as of December 31, 2013 is given below. The initial discounting effect is recorded in the Group’s reserves and includes the impact of deferred taxes arising as a result of the discounting for EUR 22.7 million as of December 31, 2013.

Details of YFPECS (before impact of discounting) are presented as follows:

Name	Maturity date	Interest rate	Convertible	Principal amount as at the end 2012	Principal amount as at the end 2013
				in millions of euros	
YFPECs C	14/05/2058	—	No	22.07	—
YFPECs C	03/12/2058	—	No	4.51	—
YFPECs C	15/06/2060	—	No	0.10	—
YFPECs C	26/08/2011	—	No	0.11	—
YFPECs C	28/11/2011	—	No	2.51	—
YFPECs C	03/12/2058	—	No	4.00	—
YFPECs E	01/12/2058	—	No	1.88	—
YFPECs K	31/12/2061	—	No	1.16	—
Master YFPECs	06/06/2062	—	No	—	38.3
Total				36.34	38.3

Details of the interest free loan registered as equity are given below.

IFL	26/04/2061	—		—	2.6
---------------	------------	---	--	---	-----

13—Other reserves (Continued)

13.3 Employee benefits reserve

This reserve contains variations related to employee benefit plans in place at different group entities that apply IAS 19R. More information is provided in note 15.

13.4 Currency translation reserve

Exchange rate differences relating to the translation of the results and net assets of the Group's foreign operations from their functional currencies to the Group's presentation currency are recognized directly in other comprehensive income and accumulated in the foreign currency translation reserve.

Exchange differences previously accumulated in the foreign currency translation reserve (in respect of translating both the net assets of foreign operations and hedges of foreign operations) are reclassified to profit or loss on the disposal of the foreign operation.

13.5 Impact of changes in ownership structure

This reserves records the impact of the changes in ownership interests held by the Group in its different subsidiaries. As described in note 3.2., the Group acquired non-controlling interests held in Altice Portugal, Cabovisao and Coditel from non-controlling interests, leading to a net decrease of EUR 120.7 million in the Group's reserves, offset by a EUR 3.3 million gain realized on the sale of Valvision. In addition to these transfers of non-controlling interests, an adjustment of EUR 14.2 million, relating to the share of non-controlling interests was recorded in the reserves.

13.6 Integration of entities under common control

As described in note 3.2.1.3, the entry of Ma Chaine Sport S.A.S. and SportV S.A. in the scope of the Group's consolidation had an impact on the reserves equal to the difference between the acquisition price and the net asset position of the companies acquired. The total consideration paid for 100% of the shares MCS amounted to EUR 23.0 million, of which EUR 10.0 million was paid in cash with the remainder generating a vendor note of EUR 13.0 million. The net equity acquired amounted to EUR 2.1 million, thus generating an adjustment of the reserves accounts of EUR 20.9 million.

The total consideration paid for 100% of the shares of SportV was EUR 12.0 million, of which EUR 5.0 million was paid in cash with the rest generating a vendor note. The net equity acquired amounted to EUR 1.7 million, thus generating an adjustment of the reserves accounts of EUR 10.3 million.

13.7 Legal reserve

According to the Luxemburg legal provisions, 5% of net profit must be obligatorily credited to a legal reserve account. The obligation to make this contribution ends when the legal reserve equal 10% or more of the share capital of the Group.

Altice VII S.à r.l.

Consolidated financial statements as of December 31, 2013 (Continued)

14—Provisions

	December 31, 2012	Business Combinations	Addition	Utilization	Divestitures, changes in foreign currency translation adjustments and other	December 31, 2013
	(in millions of euros)					
Litigations ⁽¹⁾	15.8	3.2	3.7	(6.9)	2.2	18.0
Other risks	8.0	0.2	1.3	(0.1)	(1.6)	7.9
Provisions for other expenses	1.8	4.7	0.5	(0.7)	(1.0)	5.3
TOTAL	25.6	8.2	5.5	(7.7)	(0.4)	31.2

	December 31, 2011	Business Combinations	Addition	Utilization	Divestitures, changes in foreign currency translation adjustments and other	December 31, 2012
	(in millions of euros)					
Litigations ⁽¹⁾	38.8	—	1.9	(24.0)	(0.9)	15.8
Other risks	1.7	5.0	1.4	(0.1)	(0.1)	8.0
Provisions for other expenses	—	—	1.8	—	—	1.8
TOTAL	40.5	5.0	5.1	(24.1)	(1.0)	25.6

(1) Provisions for litigations : For the year ended December 31, 2013, HOT made payments to Tali, AGICOA and ESHKOLOT copyright owners. Total payments amounted to EUR 5.4 million. HOT also recorded additional provisions for litigation based on a class action lawsuit for a total of EUR 2.9 million.

Provisions for litigations are mainly relating to, (i) claims made by associations representing the owners of certain copyrights in Israel, (ii) class action suits filed by certain consumers in Israel and (iii) lawsuits pertaining to the take-private operation performed in December 2012.

More information on these provisions is provided in note 32.. Management considers that all potential risks of cash-outs on such litigations and claims is properly evaluated and represented correctly in the consolidated financial statements for the year ended December 31, 2013.

15—Employee benefits

Breakdown of the employee benefits by entity :

	Notes	December 31, 2013	December 31, 2012
		(in millions of euros)	
Coditel Brabant		0.5	0.7
Hot Telecom	15.1	3.8	6.5
Green.ch	15.1	1.8	1.9
OMT Invest	15.1	2.2	—
Total		8.2	9.1

15—Employee benefits (Continued)

15.1 Description of employee benefits by entity

15.1.1 HOT Telecom

(a) Defined Benefit Plans

Employee benefit liabilities

HOT Telecom has several employee benefit plans:

- Short-term employee benefits

Short-term employee benefits are benefits that are forecast to be cleared in full within 12 months of the end of the annual reporting period in which the employees provide the related services. These benefits include salaries, paid annual leave, paid sick leave, recuperation and social security contributions and are recognized as expenses as the services are rendered. A liability in respect of a cash bonus is recognized when the Group has a legal or constructive obligation to make such payment as a result of past service rendered by an employee and a reliable estimate of the amount can be made.

- Post-employment benefits

The plans are normally financed by contributions to insurance companies and classified as defined contribution plans or as defined benefit plans.

Since 2011, the Group has defined contribution plans pursuant to Section 14 of the Severance Pay Law under which the Group pays regular contributions and will have no legal or constructive obligation to pay further contributions if the fund does not hold sufficient amounts to pay all employee benefits relating to employee service in the current and prior periods.

Contributions to the defined contribution plan in respect of severance or retirement pay are recognized as an expense when contributed concurrently with performance of the employee's services.

In addition, the Group has a defined benefit plan in respect of severance pay pursuant to the Severance Pay Law. According to the Law, employees are entitled to receive severance pay upon dismissal or retirement. The liability for termination of employment is measured in accordance with an actuarial evaluation of the projected unit credit. The actuarial calculation takes into account the future salary costs and the rate at which employees leave the Group, which is done on the basis of an evaluation of the timing of the payment. The amounts are presented based on discounted expected future cash flows using a discount rate determined by reference to yields on Government bonds with a term that matches the estimated term of the obligation relating to severance pay.

In respect of its severance pay obligation to certain of its employees, the Group makes current deposits in pension funds and insurance companies ("the plan assets"). Plan assets comprise assets held by a long-term employee benefit fund or qualifying insurance policies. Plan assets are not available to the Group's own creditors and cannot be returned directly to the Group.

The employee benefit liabilities, which are presented in the statement of financial position, represents the present value of the defined benefit liabilities less the fair value of the plan assets.

Re-measurements of the net liability are reflected under other comprehensive income as they arise.

Actuarial gains and losses are reflected in other comprehensive income.

- Other long-term employee benefits

The Group's net obligation in respect of other long-term employee benefits is calculated on the basis of an actuarial valuation and is in respect of the future benefit amount due to employees for services rendered in current and prior periods, taking the rate of expected salary increases into account. This amount of benefits is discounted to its present value. The discount rate is determined

Altice VII S.à r.l.
Consolidated financial statements as of December 31, 2013 (Continued)

15—Employee benefits (Continued)

by reference to the yields on Government bonds whose currency and term are consistent with the currency and term of the Group's obligation.

Re-measurements of the net liabilities are reflected in profit or loss in the period in which they arise.

- Termination benefits:

Employee termination benefits are recognized as an expense at the earlier of such time at which the Group has committed to terminate employees before the normal retirement date and it is unable to cancel the proposal or where the Group recognized costs in respect of a structural change that includes the payment of termination benefits.

The portion of the severance pay payments that is not covered by deposits, is treated by the Group as a defined benefit plan in accordance with which a liability is recorded in respect of employee benefits, and the Group deposits amounts in central severance pay funds and in appropriate insurance policies in respect of it.

The Group has defined contribution plans, in accordance with section 14 of the Israeli Severance Pay Law, in accordance with which the Group makes regular payments without it having a legal or implicit commitment to pay additional payments even if sufficient funds have not accumulated in the funds to pay all of the benefits to an employee that relate to the employee's employment in the current period and in previous periods.

Deposits in a defined contribution plan in respect of severance pay or in respect of emoluments are recognized as expense at the time of the deposit in the plan, in parallel to the receipt of the labor services from the employee and no additional provision is required in the financial statements.

(b) Expenses reflected in the statement of comprehensive income

	December 31, 2013	December 31, 2012
	(in millions of euros)	
Current service cost	3.5	4.7
Interest expenses in respect of the benefit liabilities	0.8	1.0
Expected yield in the plan assets	(0.6)	(0.8)
Net actuarial gain which has been recognized in the year	0.1	0.6
Total expenses in respect of employee benefit	3.8	5.5

(c) The plan assets (liabilities)

	December 31, 2013	December 31, 2012
	(in millions of euros)	
Liabilities in respect of a defined benefit plan	(19.3)	(26.8)
Fair value of the plan assets	15.5	20.3
Total net assets/(liabilities)	(3.8)	(6.5)

Altice VII S.à r.l.
Consolidated financial statements as of December 31, 2013 (Continued)

15—Employee benefits (Continued)

(d) *Changes in the present value of the liabilities in respect of a defined plan*

	December 31, 2013 ^(*)	December 31, 2012
	(in millions of euros)	
Opening balance	27.6	25.4
Interest expenses	0.8	1.0
Current service cost	3.6	4.6
Benefits paid	(10.6)	(3.2)
Transfer of employees to section 14	(2.1)	(1.6)
Net actuarial loss (profit)	0.0	0.6
Closing balance	<u>19.3</u>	<u>26.8</u>

(e) *Changes in the present value of the assets in respect of a defined plan*

The plan assets include assets that are held by a long-term employee benefit fund as well as in appropriate insurance policies.

	December 31, 2013	December 31, 2012
	(in millions of euros)	
Opening balance	20.9	20.7
Expected yield	0.6	0.8
Deposits by the employer into the plan	3.8	4.1
Benefits paid	(8.3)	(3.7)
Transfer of employees to section 14	(2.1)	(1.6)
Net actuarial loss	0.6	—
Closing balance	<u>15.4</u>	<u>20.3</u>

(f) *The principal assumptions:*

	December 31, 2013	December 31, 2012
	(in %)	
Discount rate	3.61	3.54
Expected yield on the plan assets	3.74	3.84
Expected yield of salary increases	2 - 5	2 - 4

15.1.2 Green.ch

(a) *Defined Benefit Plans*

The portion of the severance pay payments that is not covered by deposits, is treated by the Group as a defined benefit plan in accordance with which a liability is recorded in respect of employee benefits, and the Group deposits amounts in central severance pay funds and in appropriate insurance policies in respect of it.

The Group has defined contribution plans, in accordance with which the Group makes regular payments without it having a legal or implicit commitment to pay additional payments even if sufficient funds have not accumulated in the funds to pay all of the benefits to an employee that relate to the employee's employment in the current period and in previous periods.

Deposits in a defined contribution plan in respect of severance pay or in respect of emoluments are recognized as expense at the time of the deposit in the plan, in parallel to the receipt of the labor services from the employee and no additional provision is required in the financial statements.

Altice VII S.à r.l.
Consolidated financial statements as of December 31, 2013 (Continued)

15—Employee benefits (Continued)

(b) *Expenses reflected in the statement of comprehensive income*

	December 31, 2013	December 31, 2012
	(in millions of euros)	
Current service cost	0.4	—
Net actuarial gain which has been recognized in the year	(0.3)	—
Total expenses in respect of employee benefit	<u>0.2</u>	<u>—</u>

(c) *The plan assets (liabilities)*

	December 31, 2013	December 31, 2012
	(in millions of euros)	
Liabilities in respect of a defined benefit plan	(7.5)	—
Fair value of the plan assets	5.7	—
Total net assets/(liabilities)	<u>(1.8)</u>	<u>—</u>

(d) *Changes in the present value of the liability in respect of a defined plan*

	December 31, 2013 ^(*)	December 31, 2012
	(in millions of euros)	
Opening balance	6.6	—
Interest expenses	0.1	—
Current service cost	0.4	—
Participant contribution	0.3	—
Benefits received	0.4	—
Net actuarial loss (profit)	(0.4)	—
Closing balance	<u>7.5</u>	<u>—</u>

(e) *Changes in the present value of the assets in respect of a defined plan*

The plan assets include assets that are held by a long-term employee benefit fund as well as in appropriate insurance policies.

	December 31, 2013	December 31, 2012
	(in millions of euros)	
Opening balance	4.6	—
Expected yield	0.1	—
Deposits by the employer into the plan	0.3	—
Participant contribution	0.3	—
Benefits received	0.4	—
Net actuarial loss	(0.1)	—
Closing balance	<u>5.7</u>	<u>—</u>

Altice VII S.à r.l.

Consolidated financial statements as of December 31, 2013 (Continued)

15—Employee benefits (Continued)

(f) *The principal assumptions:*

	December 31, 2013	December 31, 2012
	(in %)	
Discount rate	2.5	—
Expected yield on the plan assets	—	—
Expected yield of salary increases	1.0	—

15.1.3 OMT Invest

(a) *Defined Benefit Plans*

The portion of the severance pay payments that is not covered by deposits, is treated by the Group as a defined benefit plan in accordance with which a liability is recorded in respect of employee benefits, and the Group deposits amounts in central severance pay funds and in appropriate insurance policies in respect of it.

The Group has defined contribution plans, in accordance with which the Group makes regular payments without it having a legal or implicit commitment to pay additional payments even if sufficient funds have not accumulated in the funds to pay all of the benefits to an employee that relate to the employee's employment in the current period and in previous periods.

Deposits in a defined contribution plan in respect of severance pay or in respect of emoluments are recognized as expense at the time of the deposit in the plan, in parallel to the receipt of the labor services from the employee and no additional provision is required in the financial statements.

(b) *Expenses reflected in the statement of comprehensive income*

	December 31, 2013	December 31, 2012
	(in millions of euros)	
Current service cost	0.1	—
Interest expenses in respect of the benefit liabilities	—	—
Expected yield in the plan assets	—	—
Net actuarial loss which has been recognized in the year	0.1	—
Total expenses in respect of employee benefit	0.2	—

(c) *The plan assets (liabilities)*

	December 31, 2013	December 31, 2012
	(in millions of euros)	
Liabilities in respect of a defined benefit plan	2.2	—
Fair value of the plan assets	—	—
Total net assets/(liabilities)	2.2	—

Altice VII S.à r.l.
Consolidated financial statements as of December 31, 2013 (Continued)

15—Employee benefits (Continued)

(d) *Changes in the present value of the liability in respect of a defined plan*

	December 31, 2013 ^(*)	December 31, 2012
	(in millions of euros)	
Opening balance	2.1	—
Interest expenses	0.0	—
Current service cost	0.2	—
Participant contribution	—	—
Benefits paid	(0.0)	—
Net actuarial loss (profit)	(0.1)	—
Closing balance	<u>2.2</u>	<u>—</u>

(e) *Changes in the present value of the assets in respect of a defined plan*

The plan assets include assets that are held by a long-term employee benefit fund as well as in appropriate insurance policies.

	December 31, 2013	December 31, 2012
	(in millions of euros)	
Opening balance	—	—
Expected yield	—	—
Deposits by the employer into the plan	—	—
Participant contribution	—	—
Net actuarial loss	—	—
Closing balance	<u>—</u>	<u>—</u>

The principal assumptions:

	December 31, 2013	December 31, 2012
	(in %)	
Discount rate	3.15	—
Expected yield on the plan assets	—	—
Expected yield of salary increases	1.5 - 2.0	—

16—Variations in non-controlling interests

	December 31, 2013	December 31, 2012
Balance at beginning of year	5.2	349.2
Share in loss for the year	(22.1)	(40.9)
Acquisition of non-controlling interests on Hot Telecom Ltd	—	(298.4)
Dividends paid to non-controlling interests	—	(26.0)
Acquisition of non-controlling interests in Altice Portugal S.A.	(9.1)	21.6
Acquisition of non-controlling interests in OMT Invest S.A.S	1.3	—
Acquisition of non-controlling interests in Winreason S.A.	0.4	—
Acquisition of non-controlling interests in Coditel Holding Lux II S.à r.l.	23.6	—
Effect of foreign exchange translation	0.2	(1.3)
Other variations	—	1.0
Balance at end of year	<u>(0.5)</u>	<u>5.2</u>

Altice VII S.à r.l.
Consolidated financial statements as of December 31, 2013 (Continued)

17—Borrowings and other financial liabilities

Total financial liabilities are broken down as follows:

	December 31, 2013	December 31, 2012
	(in millions of euros)	
Bonds	2,527.0	1,108.5
Related party bonds ⁽⁵⁾	99.2	109.0
Borrowings from financial institutions ⁽¹⁾	894.3	257.2
Finance leases ⁽²⁾	23.4	27.1
Other financial liabilities	105.9	84.9
Financial instruments	142.3	62.5
Non-current liabilities⁽³⁾	3,792.1	1,649.5
Bonds	26.4	25.4
Borrowings from financial institutions	—	86.5
Finance leases ⁽²⁾	11.4	7.8
Other financial liabilities	4.5	—
Accrued interest	31.2	2.7
Current liabilities⁽⁴⁾	73.5	122.4
Total	3,865.6	1,771.9

- (1) Borrowings from financial institutions mainly comprised of (i) EUR 764.8 million corresponding to the Altice Financing term loan facility, (ii) the Coditel Mezzanine facility for EUR 104.0 million and (iii) Green data center debt for a total of EUR 23.7 million
- (2) Liabilities related to finance leases were included in the line item 'other financial liabilities' for the year ended December 31, 2012 and have been reclassified for comparative purposes for the year ended December 31, 2013.
- (3) Non-current liabilities shown here correspond to the total of the line items, 'borrowings from banking corporations and debentures', 'long term loans from related parties' and 'other financial liabilities' as presented in the consolidated statement of financial position.
- (4) Current liabilities shown above correspond to the total of the line items, 'borrowings from banking corporations and debentures', 'other current liabilities' and 'related party bonds', as presented in the consolidated statement of financial position.
- (5) As part of the proposed initial public offering of the newly incorporated Altice S.A., it was decided to redeem the related party preferred equity certificates issued by Altice VII. The redemption proceeds will be contributed by Altice S.A. to Altice VII against shares in Altice VII and related premium.

Altice VII S.à r.l.
Consolidated financial statements as of December 31, 2013 (Continued)

17—Borrowings and other financial liabilities (Continued)

17.1 Bonds

Issuer	Fair value in millions of euros December 31, 2013	Effective interest rate	Year of maturity	Carrying amount December 31, 2013	Carrying amount (excluding transaction costs) December 31, 2013	Carrying amount December 31, 2012 (excluding transaction costs)
Hot Telecom						
—Debentures	310.1	Between 3.9% and 6.9% + Consumer Price Index	2018	280.1	282.5	269.2
Altice Financing						
—Senior Secured Notes USD 460 M	346.1	7.875%	2019	305.1	333.9	348.4
—Senior Secured Notes EUR 210M	219.1	8.00%	2019	201.8	210.5	210.5
—New Senior Secured Notes EUR 300M ⁽¹⁾	300.0	6.5%	2022	292.8	300.0	—
—New Senior Secured Notes USD 900M ⁽¹⁾	652.7	6.5%	2022	637.3	652.7	—
Altice Finco						
—Senior Notes USD 425M	309.6	9.875%	2020	309.1	309.1	322.7
—Senior Notes EUR 250M	272.2	9.00%	2023	245.3	250.0	—
—New Senior Notes USD 400M ⁽¹⁾	351.6	8.125%	2024	282.5	290.1	—
Nominal value of bonds	2,761.3			2,554.0	2,628.8	1,150.8
Of which due within one year	26.8			26.8	26.8	—
Of which due after one year	2,734.6			2,527.0	2,602.0	1,150.8

(1) New notes issued by Altice Finco S.A. and Altice Financing S.A. are held in escrow and are not used as of December 31, 2013 (See note 11).

During the year ended December 31, 2013, debentures issued by the Company included:

The Hot Telecom Debentures:

The Series A' debentures-EUR 167 million, linked to the Consumer Prices Index for Tel Aviv, bear yearly interest at a rate of 3,9%. Series A' debentures are repayable in 13 semi-annual payments commencing on September 30, 2012 and up to September 30, 2018.

The Series B' debentures-EUR 137 million bear yearly interest at a fixed rate of 6,9%. Series B' debentures are repayable in 13 semi-annual payments commencing on September 30, 2012 and up to September 30, 2018.

Altice Financing Senior Secured Notes:

Altice Financing S.A. has issued Senior Secured Notes in December 2012 and December 2013 to finance various acquisitions:

- \$ 460.0 million senior secured notes, issued in December 2012, bearing a semi-annual coupon of 7.875% and maturing on December 15, 2019.
- € 210.0 million senior notes, issued in December 2012, bearing a semi-annual coupon of 8.0% and maturing on June 15, 2023.
- \$ 900.0 million senior secured notes issued in December 2013, bearing a semi-annual coupon of 6.5% and maturing in 2022. These notes were issued in relation with the Orange Dominicana

Altice VII S.à r.l.
Consolidated financial statements as of December 31, 2013 (Continued)

17—Borrowings and other financial liabilities (Continued)

acquisition and are currently in an escrow account and will be released upon closing of the Orange Dominicana acquisition.

- € 300.0 million senior secured notes issued in December 2013, bearing a semi-annual coupon of 6.5% and maturing in 2022. These notes were issued in relation with the Orange Dominicana acquisition and are currently in an escrow account and will be released upon closing of the Orange Dominicana acquisition.

Altice Finco Senior Notes:

Altice Finco S.A. has issued Senior Notes in December 2012, June 2013 and December 2013 to finance various acquisitions:

- \$ 425.0 million senior notes issued in December 2012, bearing a semi-annual coupon of 9.875% and maturing on December 15, 2020.
- € 250.0 million senior notes, issued in June 2013, bearing a semi-annual coupon of 9.0% and maturing on June 15, 2023.
- \$ 400.0 million senior notes issued in December 2013, bearing a semi-annual coupon of 8.125% and maturing in 2024. These notes were issued in relation with the Orange Dominicana acquisition and are currently in an escrow account and will be released upon closing of the Orange Dominicana acquisition.

The Senior and Senior Secured Notes are listed on the Official List of the Luxembourg Stock Exchange and traded on the Euro MTF Market of the Luxembourg Stock Exchange.

17.2 Covenants

17.2.1 Hot Telecom

The unsecured debentures issued on the Tel Aviv Stock Exchange by the Group's subsidiary Hot Telecom include financial covenants measured on Hot Telecom performance, which mainly include:

- A debt to EBITDA ratio, which is not to exceed 6 for a period that exceeds two consecutive quarters;
- No distribution of a dividend when Hot Telecom exceeds a debt to EBITDA ratio of 5.5.

As of December 31, 2013, Hot Telecom was in compliance with all of the required financial covenants.

17.2.2 Altice Blue One

As of December 31, 2012, Altice Blue One was in default of financial covenants, though it was not in default of any scheduled payments due to the lenders. As per the debt agreements, one consequence of this default could be early or accelerated repayment of the debts, if and only if such repayments are unanimously reclaimed by all of the lending agencies.

Altice Blue One debt has refinanced its external debt on July 2, 2013 and Altice Blue One is no longer subject to any debt covenants.

17.2.3 Coditel Holding

Financial covenants have been set for Coditel Holding, in the framework of the financing agreement entered into with a pool of financial institutions on December 2, 2011, based on the consolidated accounts of Coditel Holding S.A. On June 2, 2013, the senior facilities (A and B) were refinanced and repaid by anticipation, thus releasing Coditel Holding S.A. from any covenant requirements on the senior debt facility.

As of December 31, 2013, Coditel Holding S.A. was in compliance with all of the required financial covenants on the Coditel Mezzanine debt.

Altice VII S.à r.l.
Consolidated financial statements as of December 31, 2013 (Continued)

17—Borrowings and other financial liabilities (Continued)

17.2.4 Altice Finco and Altice Financing

Altice Finco and Altice Financing, the Senior and Senior Secured Notes issuers are subject to covenants that only come into effect every time new debts are issued with the following requirements:

- Secured net debt to EBITDA ratio: < 3:1
- Unsecured net debt to EBITDA ratio: <4:1

The Group is allowed to fully consolidate the EBITDA from any subsidiaries in which they have a controlling interest and that are contained in the restricted group as defined under the indenture. In addition, the Group is allowed to use a general debt basket adjustment amounting to 4% of the total assets of the group, against the net debt of the Group.

In case the Group exceeds any of the two conditions mentioned above, it cannot incur any new debt, till such time as the ratios are met again. No other penalties are applicable in case of a breach of covenant. The Group also has access to two super senior revolvers provided under the indenture, in case of any financing needs the Group may face (for a total EUR equivalent amount of EUR 118.0 million).

17.3 Borrowings from financial institutions

In addition to the bonds described above, the Group has issued the following debts:

- A mezzanine debt issued by Coditel Holding S.A. in 2011 with a principal amount of €100.0 million, bearing cash interest at 8.5% and a PIK interest at 5.25% which is capitalized annually. This debt matures in 2016.
- A covenant lite term loan issued by Altice Financing S.A for a total amount of \$ 1,034 million (€ 795 million), bearing interest at Prime FFER, Libor + 4.5%) and maturing in June 2019.

17.4 Related party bonds

Issuer	Fair value in millions of euros December 31, 2013	Effective interest rate	Year of maturity	Carrying amount December 31, 2013	Carrying amount (excluding transaction costs) December 31, 2013	Carrying amount December 31, 2012 (excluding transaction costs)
Related party bonds						
Altice VII						
—Alpecs	94.3	Variable	2057 to 2061	94.3	94.3	104.6
—Yfpecs	4.8	4.76%	2058 to 2061	4.8	4.8	4.4
—IFL	0.2	6.79%	2061	0.2	0.2	—
Nominal value of bonds .	99.2			99.2	99.2	109.0
Of which due within one year	—			—	—	
Of which due after one year	99.2			99.2	99.2	109.0

Subordinated financial instruments have been issued by Altice VII and Coditel Holding.

(a) *Altice VII*

Subordinated financial instruments have been issued by Altice VII consists of:

YFPECs: Yield Free Preferred Equity Certificates;

ALPECs: Asset Linked Preferred Equity Certificate;

IFL: Interest Free Loans.

Altice VII S.à r.l.
Consolidated financial statements as of December 31, 2013 (Continued)

17—Borrowings and other financial liabilities (Continued)

Conversely, according to our appreciation, and upon application of IAS 32/39, following instruments have to be classified as debt instruments:

ALPECs instruments (about EUR 94.3 Million as at the end of 2013; 2012 amount: EUR 104.6 million)

YFPECs instruments (about EUR 4.8 Million as at the end of 2013; 2012 amount: EUR 4.4 million)

IFL instruments (about EUR 0.2 million at the end of 2013; 2012 amount: EUR 0.2 million)

The YFPECs have been valued using a discount rate of 4.76% given its preferred interest rate which therefore values the liabilities at EUR 4.8 million as at December 31, 2013.

17.5 Other financial liabilities

Other financial liabilities mainly consist of:

(i) Preferred equity certificates (PECs): These instruments bear a yield and shall have a maturity of 49 years.

On November 29, 2013, Altice Holding S.à r.l. acquired the PECs held by Codilink S.à r.l. (40% of the total amount). Following this transaction, all remaining PECs issued by Coditel Holding Lux II have been subscribed by Deficom Telecom, of which 26.2% is detained by Deficom Group S.A

Name	Issuing date	Maturity date	Number of instruments (in millions)	Nominal value per instrument in euro (in euro)	Interest rate	Convertible	Amount as at the end of 2012 (in millions of euros) including interests	Amount as at the end of 2013
PECs C	30/06/2011	30/06/2060	16.90	1	12.98%	No	51.4	14.9
PECs C	02/12/2011	02/12/2060	3.86	1	12.98%	No	10.5	2.8
Total			20.76				61.9	17.7

(ii) Debt related to Altice Caribbean put: Altice Caribbean, the sole shareholder of Altice Blue Two S.A.S, has the option to repurchase the minority stake in Altice Blue Two S.A.S, valued at EUR 52.7 million for the year ended December 31, 2013.

(iii) EUR 20.2 million in vendor notes owed by Altice VII S.à r.l. to the previous shareholders of MCS S.A.S. and SportV S.A., payable in 2014. Of the total purchase price of EUR 23.0 million for MCS and EUR 12.0 million for SportV S.A. cash payments were made for an amount of EUR 14.9 million in the year ended December 31, 2013. These vendor notes were settled after year end.

17.5 Maturity of financial liabilities

	December 31, 2013	< 1 year (in millions of euros)	Between 1 and 5 years	> 5 years
Bonds	2,554.0	26.8	253.7	2,273.3
Related party bonds	99.2	—	—	99.2
Borrowings from financial institutions	893.4	—	—	893.4
Finance leases	34.8	11.4	23.4	—
Accrued interest	31.2	31.2	—	—
Other financial liabilities	110.4	2.0	59.3	49.1
Financial instruments	142.3	—	142.3	—
Nominal value of borrowings	3,865.2	71.4	478.7	3,315.9

Altice VII S.à r.l.

Consolidated financial statements as of December 31, 2013 (Continued)

17—Borrowings and other financial liabilities (Continued)

	December 31, 2012	< 1 year	Between 1 and 5 years	> 5 years
		(in millions of euros)		
Bonds	1,133.9	25.4	77.3	1,031.2
Related party bonds	109.0	—	—	109.0
Borrowings from financial institutions	343.7	86.5	27.5	229.7
Finance leases	34.9	12.3	15.0	7.6
Accrued interest	3.0	3.0	—	—
Other financial liabilities	84.9	—	7.8	77.1
Financial instruments	62.5	—	—	62.5
Nominal value of borrowings	1,771.9	116.3	116.0	1,539.6

17.6 Currency of borrowings

	December 31, 2013	Euro (EUR)	US Dollar (USD)	Israeli Shekel	Swiss Franc
		(in millions of euros)			
Bonds	2,554.0	739.4	1,534.0	280.6	—
Related party bonds	99.2	99.2	—	—	—
Borrowings from financial institutions	893.4	870.0	—	—	23.4
Finance leases	34.8	5.8	—	26.5	2.5
Accrued interest	31.2	25.8	5.4	—	—
Other financial liabilities	110.4	107.1	—	3.0	0.2
Financial instruments	142.3	142.3	—	—	—
TOTAL	3,865.2	1,989.6	1,539.4	310.1	26.4

	December 31, 2012	Euro (EUR)	US Dollar (USD)	Israeli Shekel	Swiss Franc
		(in millions of euros)			
Bonds	1,133.9	—	839.3	294.6	—
Related party bonds	109	109	—	—	—
Borrowings from financial institutions	343.7	319.7	—	—	24
Finance leases	34.9	6.2	—	26.1	2.6
Accrued interest	3	1.2	1.6	—	0.2
Other financial liabilities	84.9	82.0	—	2.7	0.2
Financial instruments	62.5	—	62.5	—	—
TOTAL	1,771.9	544.2	903.4	297.3	27

17.7 Nature of interest rate

	December 31, 2013	Fixed interest rate	Floating interest rate
		(in millions of euros)	
Bonds	2,554.0	2,554.0	—
Related party bonds	99.2	5.0	94.2
Borrowings from financial institutions	892.4	129.1	764.3
Finance leases	34.8	34.8	—
Accrued interest	31.2	15.4	15.8
Other financial liabilities	110.4	103.3	7.1
Financial instruments	142.3	—	142.3
TOTAL	3,865.2	2,841.6	1,023.7

Altice VII S.à r.l.

Consolidated financial statements as of December 31, 2013 (Continued)

17—Borrowings and other financial liabilities (Continued)

	December 31, 2012	Fixed interest rate	Floating interest rate
(in millions of euros)			
Bonds	1,133.9	969.7	164.2
Related party bonds	109.0	109.0	—
Borrowings from financial institutions	343.7	229.9	113.8
Finance leases	34.9	2.6	32.3
Accrued interest	3.0	3.0	—
Other financial liabilities	84.9	82.0	2.9
Financial instruments	62.5	62.5	—
TOTAL	1,771.9	1,484.8	287.1

17.8 Derivatives

As of December 31 2013, the Group had entered into the following swap transactions:

- A coupon only cross-currency swap transaction covering USD 200 million of the USD 400 million principal of Altice Finco's Senior Notes (of which USD 25 million is unhedged), based on which Altice pays Israeli Shekels and receives US Dollars, amounting to a Euro equivalent of 145 million with a maturity date on December 15, 2017 and an interest rate composed of an ILS TELBOR 3M floating rate and a fixed spread of between 8.0% and 8.25%
- A coupon only cross-currency swap transaction covering USD 225 million of the USD 450 million principal of Altice Financing's Senior Secured USD Notes (of which USD 10 million is unhedged), on the basis of which Altice pays Israeli Shekels and receives US Dollars, amounting to a Euro equivalent of EUR 163 million with a maturity date on December 15, 2017 and an interest rate composed of an ILS TELBOR 3M floating rate of 1.819% and a fixed spread of between 5.9% and 6.2%
- A coupon only cross-currency swap transaction covering EUR 100 million of the EUR 200 million principal of Altice Financing's Senior Secured Euro Notes (of which EUR 10 million is unhedged), based on which Altice pays Israeli Shekels and receives Euros, amounting to EUR 100 million with a maturity date on December 15, 2017 and an interest rate composed of an ILS TELBOR 3M floating rate of 1.819% and a fixed spread of 5.775%
- A coupon only cross-currency swap transaction covering a part of the USD 1,034 million Term loan notional (USD 292.8 million), in which Altice pays Israeli Shekels and receives US Dollars, amounting to USD 212 million with a maturity date on October 31, 2018 and an interest rate composed of an ILS TELBOR 3M floating rate of between 1.18 and 1.2% and a fixed spread of between 5.0% and 5.6%
- A coupon only cross-currency swap transaction covering part of the USD 1,034 million Term loan notional (USD 540.5 million), in which Altice pays Euros and receives US Dollars, amounting to EUR 392 million with a maturity date on October 31, 2018 and an interest rate composed of an EURIBOR 3M floating rate of between 0.22% and 0.26% and a fixed spread of between 4.5% and 4.8%

As of December 31, 2013, the Group has entered into the following forward transactions:

- A forward transaction covering USD 500 million of the total USD nominal due at maturity of the Altice Finco USD Senior Notes and Altice Financing USD Senior Secured Notes (USD 885 million) based on which Altice pays Israeli Shekels and receives US Dollars, with a hedged rate ranging from 4.28-4.33 ILS/USD.
- A forward transaction to cover the repayment of a part of the nominal of the USD 1,034 million Term loan at maturity, in which Altice pays Israeli Shekels and Euros to receive US Dollars. As part of the

Altice VII S.à r.l.

Consolidated financial statements as of December 31, 2013 (Continued)

17—Borrowings and other financial liabilities (Continued)

transaction, Altice will pay ILS 1,076 million and receive USD 293 million at a hedged rate of 3.678 ILS/USD and will pay EUR 415 million and receive USD 541 million at a hedged rate of 1.301.

- A coupon only forward transaction covering USD 200 million of the USD 400 million Senior Notes issued by Altice Finco (of which USD 25 million are unhedged), in which Altice pays Israeli Shekels and receives US Dollars, with an average hedged exchange rate of 4.081 ILS/USD.
- A coupon only forward transaction covering USD 225 million of the USD 450 million Senior Secured Notes issued by Altice Financing (of which USD 10 million are unhedged), in which Altice pays Israeli Shekels and receives US Dollars, with an average hedged exchange rate of 4.081 ILS/USD.
- A coupon only forward transaction covering EUR 200 million of the EUR 200 million Senior Secured Notes issued by Altice Financing (of which EUR 10 million are unhedged), in which Altice pays Israeli Shekels and receives Euros, with an average hedged exchange rate of 5.036 ILS/EUR.

17.9 Non-cash transactions

Non-cash transactions consist of transactions where the Group has made payments to sellers of acquired entities or lenders (in case of debt repayments), with the cash being transferred directly to the third party.

The details of non-cash transactions are given below:

	<u>December 31, 2013</u>
(in millions of euros)	
Transaction costs related to acquisitions	(35.8)
Transaction with non-controlling interests	(120.9)
Net payments on acquisition of subsidiaries	(240.1)
Repayment of external debts	(641.7)
TOTAL	<u>(1,038.5)</u>

18—Obligations under finance leases

18.1 Leasing arrangements

The Group leased certain of its office facilities under financial leases. The average lease term is 5 years (2012: 5 years). The Group has options to purchase the equipment for a nominal amount at the end of the lease terms. Obligations under finance leases are secured by the lessors' title to the leased assets. Entities with major lease contracts are, (i) HOT and HOT Mobile, (ii) Outremer Telecom and (iii) Auberimmo.

Interest rates underlying all obligations under finance leases are fixed at respective contract dates ranging from 3.5% to 5.5% (2012: 3.75% to 6%) per annum.

Altice VII S.à r.l.

Consolidated financial statements as of December 31, 2013 (Continued)

18—Obligations under finance leases (Continued)

18.1.1. Leasing arrangements

	Minimum lease payments	
	31 December 2013	31 December 2012
Less than one year	12.6	12.3
Between one and two years	7.3	7.2
Between two and three years	5.0	4.9
Between three and five years	2.8	2.9
More than five years	7.6	7.6
Less: future finance expenses	(2.9)	(2.6)
Present value of minimum lease payments	35.3	34.9
	<u>31 December 2013</u>	<u>31 December 2012</u>
Included in the consolidated financial statements as:		
Current borrowings (note 17)	<u>23.4</u>	<u>27.1</u>
Non-current borrowings (note 17)	<u>11.4</u>	<u>7.8</u>
Total	<u>34.8</u>	<u>34.9</u>

Current leasing obligations for HOT are listed below:

The HOT group (HOT Telecom and HOT Mobile) leases equipment under finance leasing agreements. An arrangement exists within the framework of the leases, which does not meet the legal definition of leasing, but which is treated as a leasing agreement, based upon its terms. The leased equipment serves as collateral for the liabilities under the lease contract. As of December 31, 2013 the net carrying value of the leased facilities and equipment is EUR 38.1 million (NIS 182 million) (2012—EUR 41.7 million/NIS 205 million).

HOT Mobile has finance leasing in an amount of EUR 2.9 million in accordance with its rental contract with the company “Airport City” Ltd., which is for a period of 10 years ending in 2019. As of December 31, 2013, there is no balance recorded in the accounting records in respect of leasehold improvements (as of December 31, 2012, the net carrying value of leasehold improvements was EUR 3.0 million).

The Group has recorded finance leasing in respect of the Bezeq agreement. As of December 31, 2013, the finance leasing commitment in respect of the long-term Bezeq rental fees was updated by an amount of EUR 0.4 million (NIS 2 million), as a result of additional payments made in respect of the leasing in the reporting period (as of December 31, 2012—EUR 0.4 million/NIS 2 million).

Other leasing contracts exist at Auberimmo, a datacenter owned by the Group and operating in France. The facility was purchased under a finance lease agreement for an initial amount of EUR 5.6 million. A second tranche was issued to carry out renovations and leasehold improvements, amounting to a total of EUR 3.0 million.

19—Financial risk factors

In the course of its business, the Group is exposed to a number of financial risks: credit risk, liquidity risk, market risk (including foreign currency risk and interest rate risk) and other risks (including equity price risk and settlement risk). This note presents the Group’s objectives, policies and processes for managing its financial risk and capital.

Financial risk management is an integral part of the way the Group is managed. The Board of Managers establishes the Group’s financial policies and the Chief Executive Officer establishes objectives in line with these policies.

Altice VII S.à r.l.
Consolidated financial statements as of December 31, 2013 (Continued)

19—Financial risk factors (Continued)

The Group is not subject to any externally imposed capital requirements.

19.1 Credit risk

The Group does not have significant concentrations of credit risk. The credit risk may arise from the exposures of commitments under a number of financial instruments with one body or as the result of commitments with a number of Groups of debtors with similar economic characteristics, whose ability to meet their commitments could be similarly affected by economic or other changes.

The Group's income mainly derives from customers in Israel, in the French Overseas Territories and in Europe (Belgium, Luxembourg, Portugal and Switzerland). The Group regularly monitors its customers' debts and provisions for doubtful debts are recorded in the consolidated financial statements, which provide a fair value of the loss that is inherent to debts whose collection lies in doubt.

The Group does not have significant concentration of credit risk, as a result of the Group's policy, which ensures that the sales are mostly made under standing orders or via credit cards.

19.2 Liquidity risk

Ultimate responsibility for liquidity risk management rests with the Board of Managers, which manages liquidity risk by maintaining adequate reserves, banking facilities and reserves borrowing facilities, by continuously monitoring forecast and actual cash flows, and by matching the maturity profiles of financial assets and liabilities.

19.3 Market risks

The Group is exposed to risk from movements in foreign currency exchange rates, interest rates and market prices that affect its assets, liabilities and anticipated future transactions.

19.3.1 Interest rate risk

Interest rate risk comprises the interest price risk that results from borrowings at fixed rates and the interest cash flow risk that results from borrowings at variable rates.

The Group has an exposure to changes of interest rate in the market, deriving from long-term loans that have been received and which bear variable rate interest.

Interest structure of non-current financial debt (including interest effects of derivatives):

	December 31, 2013	December 31, 2012
	(in millions of euros)	
Financial debt at fixed rates	2,841.6	1,484.8
Financial debt at variable rates	1,023.7	287.1
TOTAL	<u>3,865.2</u>	<u>1,771.9</u>

31 December 2013	Weighted average effective interest rate	< 1 year	1 - 5 years	5+ years	Total	Carrying amount
Non-interest bearing	—	—	—	4.9	4.9	4.9
Variable interest rate instruments ⁽¹⁾	5.9%	58.7	989.89	481.1	1,529.7	1,023.7
Fixed interest rate instruments . . .	7.7%	272.62	1,942.42	1,712.64	3,927.68	2,841.6

Altice VII S.à r.l.

Consolidated financial statements as of December 31, 2013 (Continued)

19—Financial risk factors (Continued)

31 December 2012	Weighted average effective interest rate	< 1 year	1 - 5 years	5+ years	Total	Carrying amount
Non-interest bearing	—	—	—	4.4	4.4	4.4
Variable interest rate instruments	5.1%	—	5.6	326.3	842.2	287.1
Fixed interest rate instruments . .	7.4%	—	—	839.4	839.4	1,484.8

(1) The carrying amount of variable interest rate instruments excludes the following items included in note 17.6: 'Accrued interest, Other financial liabilities and financial instruments'.

19.3.2 Israeli CPI risk

The Group has borrowed from banks and issued debentures that are linked to the changes in the Israeli CPI. Also, the Group has deposits and gave loans that are linked to the changes in the Israeli CPI. The net amount of the financial instruments that are linked to the Israeli CPI and for which the Group is exposed to changes in the Israeli CPI amounted to approximately EUR 187.0 million (NIS 895 million) as of December 31, 2013.

19.3.3 Foreign currency management

1. Foreign currency sensitivity analysis

The Group is exposed to foreign currency risk from transactions and translation. Transactional exposures are managed within a prudent and systematic hedging policy in accordance with the Group's specific business needs. Translation exposure arises from the consolidation of the financial statements of foreign operations in euros, which is, in principle, not hedged. The Group's objective is to manage its foreign currency exposure through the use of currency forwards, futures and swaps.

	December 31, 2013		
	Israeli Shekel	Swiss Franc	Total
	(in millions of euros)		
Profit for the year			
Increase of 10% in exchange rate	(12.8)	(0.2)	(12.9)
Decrease of 10% in exchange rate	12.8	0.2	12.9
Equity			
Increase of 10% in exchange rate	5.6	2.1	7.6
Decrease of 10% in exchange rate	(5.6)	(2.1)	(7.6)
	December 31, 2012		
	Israeli Shekel	Swiss Franc	Total
	(in millions of euros)		
Profit for the year			
Increase of 10% in exchange rate	(12.9)	(0.1)	(13.1)
Decrease of 10% in exchange rate	12.9	0.1	13.1
Equity			
Increase of 10% in exchange rate	23.3	3.0	26.3
Decrease of 10% in exchange rate	(23.3)	(3.0)	(26.3)

Exchange differences recorded in the income statement represented a profit of EUR 66.4 million in 2013 (2012: loss of EUR 22.5 million). They are allocated to the appropriate headings of expenses by nature.

The Group estimates that a 10% variation of foreign currencies against euro parity is a relevant change of variables and reasonably possible risk in a year and the presented above allows to assess the impact of a 10% increase of foreign currencies against euro on net result and reserves. A 10% decrease would have a symmetrical impact with the same amounts but in the opposite direction.

Altice VII S.à r.l.

Consolidated financial statements as of December 31, 2013 (Continued)

19—Financial risk factors (Continued)

2. Foreign currency hedging

It is the policy of the Group to enter into hedging foreign exchange contracts to cover specific foreign currency payments and receipts.

The following table details the hedging contracts outstanding at the end of the financial year :

	<u>31/12/13</u> Average exchange rate	<u>31/12/13</u> Foreign currency	<u>31/12/13</u> Notional Value	<u>31/12/13</u> Fair Value of assets ⁽¹⁾
Outstanding swap contracts				
Outstanding swap contracts (ILS coupons only)	4.34	3,201.8	620.6	(25.0)
Outstanding swap contracts (EUR coupons only)	0.79	415.5	392.0	(12.9)
Outstanding forward contracts (ILS coupons only)	4.31	2,154.3	426.7	(22.7)
Outstanding forward contracts (ILS nominal only)	5.07	2,125.0	362.6	(81.7)

(1) Fair value of swap and forward contracts as of December 31, 2012 amounted to EUR 62.5 million

19.3.4 Price risk

The Group has investments in listed financial instruments, shares and debentures that are classified as available-for-sale financial assets and financial assets at fair value through profit or loss in respect of which the Group is exposed to risk of fluctuations in the security price that is determined by reference to the quoted market price. As of December 31, 2013, the carrying amount of these investments was EUR 9.4 million (6.1 million as of December 31, 2012).

19.4 Gearing computation

For the year ended December 31, 2013, the Altice VII Group had a negative net equity position of EUR 261.2 million, thus resulting in a negative gearing ratio.

	<u>December 31, 2013</u>	<u>December 31, 2012</u>
	(in millions of euros)	
Net Debt	3,865.6	1,771.5
Cash and cash equivalents	(61.3)	(129.7)
Total equity	(261.2)	285.7
Gearing	(1,456)%	575%

19—Financial risk factors (Continued)

19.5 Fair value of financial assets and liabilities

19.5.1 Fair value of the Group's financial assets and financial liabilities that are measured at fair value on a recurring basis

Some of the Group's financial assets and financial liabilities are measured at fair value at the end of each reporting period. The following table gives information about how the fair values of these financial assets and financial liabilities are determined (in particular, the valuation technique(s) and inputs used).

Financial assets/ Financial liabilities	Fair value as at		Fair value hierarchy	Valuation technique(s) and key input (s)	Significant unobservable differences	Relationship of unobservable differences
	31/12/2013	31/12/2012				
Foreign currency forward contracts (see notes 17.8)	(104.9)	(52.6)	Level 2	Zero curve	N/A	N/A
					N/A	N/A
Interest rate swaps (see note 17.8)	(37.9)	(9.8)	Level 2	Zero curve	N/A	N/A
					N/A	N/A
AFS					N/A	N/A
—Wananchi ⁽¹⁾	31.9	—	Level 3	Internal approach using business plans	N/A	N/A
—Partner and Co.	8.4	6.1	Level 1	Quoted price in an active market	N/A	N/A

(1) In April 2012, the Group made an investment in the East-African cable operator Wananchi, to gain a foothold in the strategic and fast developing African cable and telecom market. To date the Group has invested a total of EUR 34.9 million (\$ 48.4million, of which EUR 31.9 million in equity and EUR 3.0 as a convertible note, as of the year ended December 31, 2013) in this venture, alongside other industry peers, and has acquired a total stake of 17.5% in Wananchi. Given the specific geo-economic context of the zone that Wananchi operates in, the high growth rate, infrastructure development needs and volatilities associated with the region, the Board of Managers considers that the carrying amount of its investment reflects the fair value of the investment as of December 31, 2013.

19.5.2 Reconciliation of Level 3 fair value measurements

	Available for sale (unlisted shares)	Others	Total
31 December 2013			
Opening balance	0.0	—	0.0
Total gains or losses:			
—in profit or loss	0.0	—	0.0
—in other comprehensive income	—	—	—
Purchases ^(*)	31.9	—	31.9
Issues	—	—	—
Disposals/settlements	—	—	—
Transfers in level 3	—	—	—
Transfers out of level 3	—	—	—
Closing balance	31.9	—	31.9

There were no available for sale instruments classified as level 3 for the year ended December 31, 2012.

(*) As at December 31, 2012 and during the year 2013, the Group invested into convertible bonds issued by Wanachi. Such bonds have been converted during the year in exchange for shares of Wananchi.

Altice VII S.à r.l.

Consolidated financial statements as of December 31, 2013 (Continued)

20—Trade and other payables

	December 31, 2013	December 31, 2012
	(in millions of euros)	
Trade payables	392.2	314.2
Corporate and social security contributions	29.8	24.5
Other payables	94.3	46.3
Amounts due to related parties	0.1	0.2
Deposit and guarantee received	0.4	—
Total current payables	516.6	385.2
Trade payables-acquisition of assets	13.0	5.9
Other payables	16.0	32.9
Total non-current payables	29.0	38.8

The increase in trade payables can mainly be attributed to the acquisitions of Outremer, ONI and integration of MCS and SportV in the scope of consolidation of the Group in 2013.

The increase in income tax payables can be attributed to an improvement in the profit before tax at HOT and a concomitant increase in the income tax rate in Israel from 25.0% to 26.5% as compared to FY2012.

21—Deferred revenues

	December 31, 2013	December 31, 2012
	(in millions of euros)	
Current deferred revenue	55.9	34.1
Non-current deferred revenue	10.6	10.8
Total deferred revenues	66.5	44.9

Current deferred revenues refer to revenues recognized from customers billed in advance of the monthly cut-off. Non-current deferred revenues result from multi-year contracts with business customers.

The increase in deferred revenues for the year ended December 31, 2013 was mainly due to an increase in price of certain products for the year ended December 31, 2013 and the subsequent billing and revenue collection of these subscriptions before the year end.

Altice VII S.à r.l.

Consolidated financial statements as of December 31, 2013 (Continued)

22—Classification and fair value of financial assets and liabilities

On December 31, 2013 and 2012, the principles for measuring financial instruments and their market value break down as follows:

	December 31, 2013			
	Book value	Amortized cost	Fair Value	
			Fair value through profit/loss	Assets available for sale
	(in millions of euros)			
Current assets				
Cash and cash equivalents	61.3	61.3	—	—
Restricted cash	1,242.7	1,242.7	—	—
Trade receivables	194.0	194.0	—	—
Other receivables	37.1	37.1	—	—
Non-current assets				
Restricted cash	1.8	1.8	—	—
Loans and receivables	3.0	3.0	—	—
Available for Sale	40.3	—	—	40.3
Long term trade receivables	5.5	5.5	—	—
Other long-term trade receivables	22.8	22.8	—	—
	<u>1,608.5</u>	<u>1,568.3</u>	<u>0.0</u>	<u>40.3</u>
	<u>Book value</u>	<u>Amortized cost</u>	<u>Fair value</u>	
Current liabilities				
Credit from banking corporations and debentures	57.6	57.6	—	—
Loans from related parties	—	—	—	—
Trade payables	383.4	383.4	—	—
Others payables	246.0	246.0	—	—
Other current liabilities	15.9	15.9	—	—
Non-current liabilities				
Loans from banking corporations and debentures	3,520.5	3,520.5	—	—
Other financial liabilities	271.6	129.3	—	142.3
Other non-current liabilities	39.6	39.6	—	—
	<u>4,534.6</u>	<u>4,392.3</u>	<u>—</u>	<u>142.3</u>
	December 31, 2012			
	Book value	Amortized cost	Fair value through profit/loss	Assets available for sale
Current assets				
Cash and cash equivalents	129.7	129.7	—	—
Trade receivables	150.8	150.8	—	—
Other receivables	37.9	37.9	—	—
Non-current assets				
Restricted cash	9.6	9.6	—	—
Investments in financial assets available for sale	—	—	—	—
Available for Sale	6.1	—	—	6.1
Long term trade receivables	18.7	18.7	—	—
Other long-term trade receivables	24.6	24.6	—	—
	<u>377.4</u>	<u>371.3</u>	<u>—</u>	<u>6.1</u>

Altice VII S.à r.l.

Consolidated financial statements as of December 31, 2013 (Continued)

22—Classification and fair value of financial assets and liabilities (Continued)

	<u>Book value</u>	<u>Amortized cost</u>	<u>Fair value</u>
Current liabilities			
Credit from banking corporations and debentures	113.2	113.2	—
Trade payables	311.3	311.3	—
Others payables	118.8	118.8	—
Short-term loans from related parties	2.7	2.7	—
Non-current liabilities			
Loans from banking corporations and debentures	1,365.7	1,365.7	—
Long-term loans from related parties	109.0	109.0	—
Other financial liabilities	174.5	112.0	62.5
Other non-current liabilities	49.5	49.5	—
	<u>2,244.7</u>	<u>2,182.2</u>	<u>—</u>

23—Taxes on income

23.1 Income tax (expense)/benefit

	<u>December 31, 2013</u>	<u>December 31, 2012</u>
	(in millions of euros)	
Current income tax	(38.0)	4.2
Deferred taxes on deductible temporary differences	<u>30.6</u>	<u>21.8</u>
TOTAL	<u>(7.4)</u>	<u>26.0</u>

	<u>December 31, 2013</u>	<u>December 31, 2012</u>
	(in millions of euros)	
Current tax assets	14.6	5.5
Current tax liabilities	<u>(57.1)</u>	<u>(10.7)</u>
TOTAL	<u>(42.5)</u>	<u>(5.2)</u>

23.2 Deferred tax assets and liabilities

	<u>December 31, 2012</u>	<u>Reclassifications</u>	<u>Business combination</u>	<u>From equity</u>	<u>From profit and loss</u>	<u>December 31, 2013</u>
	(in millions of euros)					
Other	0.4	0.2	—	—	—	0/4
IAS 19R	—	(0.2)	—	0.7	0.3	0.8
Employee Benefits	—	(0.2)	—	0.7	0.3	0.8
IAS 36, Depreciable fixed assets	(0.6)	0.6	—	—	—	—
IAS 38, Intangible assets	—	—	1.3	—	0.1	1.4
IAS 39, Financial Instruments	19.0	—	—	(1.5)	26.2	43.7
Compensation DTA/ DTL	—	(6.6)	—	—	—	(6.6)
Other	<u>0.4</u>	<u>0.4</u>	<u>—</u>	<u>4.9</u>	<u>2.1</u>	<u>7.7</u>
Total deferred taxes assets	<u>19.3</u>	<u>(6.1)</u>	<u>1.3</u>	<u>4.1</u>	<u>28.7</u>	<u>47.4</u>

Altice VII S.à r.l.

Consolidated financial statements as of December 31, 2013 (Continued)

23—Taxes on income (Continued)

	December 31, 2012	Reclassification	Business combination	From equity	From profit and loss	December 31, 2013
	(in millions of euros)					
Customer relationships	51.3	(.3)	15.1	—	(4.1)	62.0
Brand	16.7	.3	13.7	—	—	30.8
Other Intangible assets	21.3	14.1	2.0	2.3	17.6	57.3
Reevaluation of						
Tangible assets	30.1	(8.8)	.2	.0	(4.1)	17.4
IAS 23, Borrowing						
Costs	3.1	—	—	—	—	3.1
IAS 36, Depreciable						
fixed assets	(8.8)	(4.9)	—	(4)	32.0	17.8
Present value of						
YFPECS financial						
instrument	9.3	—	—	—	.4	9.7
Present value of IFL						
financial instrument	—	—	—	1.1	—	1.1
Capitalisation of						
transaction costs	—	—	—	—	7.8	7.8
Temporary differences	22.3	(22.3)	—	—	—	—
Other	3.1	22.5	—	6.6	(49.4)	(17.2)
Compensation DTA/DTL	—	(6.6)	—	—	—	(6.6)
Total deferred taxes						
liabilities	148.4	(6.0)	31.0	9.6	.2	183.3

	December 31, 2011	Business combination	From equity	From profit and loss	December 31, 2012
	(in millions of euros)				
Other	0.2	—	—	0.2	0.4
IAS 16, Property, Plant and Equipment	0.1	—	—	0.3	0.4
IAS 36, Depreciable fixed assets	—	—	(0.6)	—	(0.6)
IAS 38, Intangible assets	—	—	—	—	—
IAS 39, Financial Instruments	—	—	—	19.0	19.0
Total deferred taxes assets	0.3	—	(0.6)	19.5	19.3

	December 31, 2011	Business combination	From equity	From profit and loss	December 31, 2012
	(in millions of euros)				
Customer relationships	52.0	3.6	—	(2.8)	51.3
Brand	9.3	7.4	—	—	16.7
Other Intangible assets	23.9	—	(4.7)	2.1	21.3
Reevaluation of Tangible assets	11.0	23.2	—	(4.1)	30.1
IAS 23, Borrowing Costs	3.6	—	—	(0.4)	3.1
IAS 36, Depreciable fixed assets	(11.1)	—	(1.4)	3.6	(8.8)
Present value of YFPECS financial					
instrument	9.0	—	—	0.2	9.3
Temporary differences	22.8	—	—	(0.5)	22.3
Other	3.1	—	0.1	(0.1)	3.1
Total deferred taxes liabilities	123.7	32.7	(6.0)	(2.0)	148.4

Altice VII S.à r.l.

Consolidated financial statements as of December 31, 2013 (Continued)

23—Taxes on income (Continued)

23.3 Reconciliation between the effective tax rate and the theoretical tax rate

	December 31, 2013	December 31, 2012
	(in millions of euros)	
Net income	(208.3)	(189.8)
Share of net income-associates	—	—
Share of net income-equity holders	(208.3)	(189.8)
Tax charge [(-) expenses/(+) income]	(7.4)	(26.0)
Earnings/(Loss) before tax	(200.9)	(215.8)
Theoretical tax rate	29.22%	28.80%
Income tax calculated on theoretical tax	58.7	62.1
Impact of:		
Effect of different tax rates of subsidiaries depending in other jurisdictions	(6.5)	(5.8)
Permanent differences	(9.5)	(57.0)
Restatements without tax impact	(2.9)	18.7
Utilization of previously non capitalized tax credit	13.9	20.0
Carry-back	0.0	0.1
Tax loss carry forwards of the periods non activated	(61.2)	(13.2)
Effect of unused tax losses not recognized as Deferred tax asset	—	1.0
Effective Tax	(7.4)	25.9
Effective tax rate	4%	(12%)

Permanent differences present in different Group companies are summarized below:

	Altice VII	ABO	Altice Financing	Cool Holding	Hot Mobile	Others	December 31, 2013
Permanent differences	(1.5)	(3.9)	22.7	(0.5)	(2.5)	(0.6)	13.6
Tax adjustments	—	—	—	0.4	1.0	—	1.4
Regularization of deferred tax from prior periods	—	—	—	(8.3)	—	—	(8.3)
Regularization of local tax from prior periods	—	—	—	3.5	—	—	3.5
Earnout adjustment	—	—	(13.4)	—	—	(0.1)	(13.5)
Tax provisions	—	—	(6.8)	—	—	—	(6.8)
Others	—	0.3	—	—	—	0.3	0.6
Total	(1.5)	(3.6)	2.4	(4.9)	(1.5)	(0.4)	(9.5)

23.4 Tax assessments

23.4.1 Hot Telecom

On December 22, 2013, an agreement was signed between Cool Holdings Ltd and all of its subsidiary companies (except for HOT Mobile Ltd.) (hereinafter in this section—the companies) and the Israeli Income Tax Authority for the closure of disputes that had arisen in the assessment discussions for the years 2006 - 2011 and in continuation of the tax assessments that had been received in December 2009 and during the course of 2010 for the 2006 - 2008 tax years. Pursuant to the compromise agreements the companies will be required to pay an additional amount of tax in respect of the said tax years, primarily in respect of timing differences in respect of the depreciation of the infrastructure and the cables network and the amortization of intangible assets. The implementation of the compromise agreements will result in the Company having chargeable income in 2012 and 2013 as well.

Consolidated financial statements as of December 31, 2013 (Continued)

23—Taxes on income (Continued)

HOT Telecom's management has recorded the provision relating to the assessments in its financial statements in the past.

The impact of such assessment agreement in HOT's financial statements, including in respect of the updating of the HOT's deferred tax balances, is a net income of EUR 5.0 million.

Most of the companies have been issued with final tax assessments up to and including the 2011 tax year. HOT Mobile has been issued with tax assessments up to and including the 2009 tax year, which are deemed to be final.

23.4.2 Cabovisao

For the years 2012 and 2013, Cabovisao is subject to corporate income tax ("IRC—Imposto sobre o Rendimento das Pessoas Colectivas") at a rate of 25%, increased (i) up to a maximum of 1.5% of taxable income through a municipal tax ("Derrama"); and (ii) by a 3% and 5% state tax ("Derrama Estadual") applicable on taxable income between 1,5 million Euros and EUR 10 million (EUR 7.5 million as from January 1, 2013, following a change in Portuguese tax legislation occurred in December 2012) and on taxable income in excess of EUR 10 million (EUR 7.5 million as from January 1, 2013), respectively, in accordance with the article 87- A of the Portuguese Corporate Income Tax code, resulting in a maximum aggregate tax rate of approximately 31.5%.

In accordance with article 88^o of the Portuguese Corporate Income Tax code, the Company is subject to an autonomous taxation over some expenses at the rates defined in that article.

As at December 31, 2013, the Company's tax returns, for the fiscal periods of 2006 until 2010, are being reviewed by Portuguese tax authorities. During the year ended December 31, 2013, the Company already received a tax notification, adjusting the Company's tax losses obtained in the fiscal year ended 2006, in the amount of approximately EUR 16.5 million. However, as of December 31, 2013, any carrying forward tax losses obtained in the fiscal year ended 2006 already expired, and therefore cannot be used to reduce future taxable profits.

The Company was subject to an inspection from the Portuguese tax authorities for the fiscal years 2003 to 2006, and the outcome was the following:

- An assessment of the Portuguese Tax Authorities related to 2005, requested an adjustment of tax losses in the amount of EUR 17.2 million, as well as an additional tax payment in the amount of EUR 4.1 million for withholding tax and stamp tax. The Company paid EUR 2.9 million and contested this decision through an appeal, but has not received the final decision yet. The unpaid amount of, approximately, EUR 1.0 million (excluding related late payment interests) was contested on appeal. In the year ended August 31, 2012, the Corporate Tax Authority accepted the claim. As of today, there were not any subsequent deliberations after that decision. The Board of Managers understands that the final outcome of this matter will be favorable to the Company.
- An assessment of the tax payable concluded that there was withholding tax due in the amount of approximately EUR 5.2 million (excluding related late payment interests). Cabovisao doesn't agree with this assessment, having filed a gracious complaint and submitted a bank guarantee in the amount of approximately EUR 6.8 million. As of December 31, 2013, the administrative and tax court of Almada didn't pronounce itself on that claim. The Board of Managers understands that the final outcome of this matter will be favorable to the Company.

23.4.3 Other entities

The Board of Managers has not identified any other material tax assessments in other Group entities.

Consolidated financial statements as of December 31, 2013 (Continued)

23—Taxes on income (Continued)

23.5 *Unrecognized deferred tax assets*

As at December 31, 2013, unrecognized deferred tax assets amount to EUR 253.0 million and are mainly split as follows:

	December 31, 2013	December 31, 2012
	(in million Euros)	
Cool Holding and HOT Telecom	(13.9)	—
HOT Mobile	(118.9)	(10.8)
Altice Financing	(3.9)	—
Cabovisao	(56.0)	(51.3)
Altice Finco	(1.8)	—
Altice Holdings	(36.9)	—
Altice Caribbean	(1.5)	—
Altice Blue Two	(6.4)	—
ONI	(11.8)	—
Others	(2.0)	—
Total	<u>(253.0)</u>	<u>(62.2)</u>

24—Segment analysis

24.1 *Definitions of segments*

Given the geographic spread of the various Group entities, it logically follows that an analysis and control by geography is inalienable to Group strategy of managing its different businesses. It has thus been decided by the central management team to analyse the business across geographies and then by activity. The following geographies have been identified:

- Israel,
- Belgium and Luxembourg (Western Europe),
- Portugal (Western Europe),
- French Overseas Territories (Antilles and Indian Ocean),
- Others (Switzerland, Africa, France etc.).

Activities have been split as follows:

- Cable,
- Mobile,
- B2B and Others (Content/etc.).

Following the signature of agreements to acquire Tricom and Orange Dominicana in the Dominican Republic in October and November 2013 respectively, a new segment, “Dominican Republic”, will be defined. Given the nature of the activities of the two firms, there will be no changes to the activities segment.

24.1.1 **Operational KPIs**

It has also been decided by Management that operating subsidiaries shall report operational KPIs every week together with financial KPIs every month, using a standard reporting format.

24—Segment analysis (Continued)

The main operational KPIs include:

The main operational KPIs that will be tracked will be:

- Subscriber base evolution (both cable and mobile),
- ARPU (Average Revenue per Unit) (cable and mobile),
- Other relevant cost drivers.

These KPIs are benchmark indicators followed throughout the industry and allow for a thorough and accurate analysis of the business and strategic decision making.

24.1.2 Financial KPIs

Each local operational company will also report on a monthly basis the following financial KPIs by segment:

- Revenues (Cable/Mobile/B2B and Others),
- Cost of Sales (Cable/Mobile/B2B and Others),
- Capex (Cable/Mobile/B2B and Others).

The central team believes that given the uniformity in the accounting and nature of operating expenses and given the experience and competence of the Group in managing operating costs, the main indicator that can vary between business units is the gross margin.

Capital expenditure (Capex) is an important indicator to follow, as the profile varies greatly between the two activities:

The cable business has fixed Capex requirements that are mainly discretionary (network, platforms, general), and variable Capex requirements related to the connection of new customers and the purchase of Customer Premise Equipment (TV decoder, modem, etc).

Mobile Capex are mainly driven by investment in new mobile sites, upgrade to new mobile technology and licences to operate. Once Capex are engaged and operational, there are limited Capex requirement.

Management believes that operations in Switzerland are currently not substantial enough to require a separate reporting segment, and will be reported under 'B2B and Others'. However, as these activities grow, it is intended that they are also reported under a separate segment with relevant operating KPIs specific to the activity.

24.2 Regional specificities

24.2.1 Israel

Israel is currently an important contributor to the Group revenues and EBITDA and has particularities that differentiate it. For this reason, it is classified as a separate region.

It is characterized by a high broadband and cable penetration and a very technology-savvy population. Segments within the Israeli telecom market show different level of maturity and competition, with relatively frequent interventions from the regulator. Management is factoring expectations for price pressure and increasing competition in its strategic plan.

Triple play penetration is low and represents a valuable growth driver.

The regulatory environment does not yet allow for quadruple play packages (coupling fixed and mobile services), which Management need to consider when setting up integration plans and operational synergies. The prevailing political environment in the region can also have adverse impacts on the

24—Segment analysis (Continued)

development of the business, as a deterioration of the situation may have serious repercussions on the market environment and may even lead to physical damage of the infrastructure.

24.2.2 Belgium and Luxembourg

Even though Belgium/Luxembourg and Portugal can be considered to be the same sub-region, the challenges posed by these two regions are quite different.

The Belgian and Luxembourg territories have a high standard of living and well developed economies, which translates into higher prices for services. The markets are quite mature, with high broadband penetration. Customers are willing to pay more for premium services and hence price pressure appears limited.

These regions are marked by the presence of many well established local cable operators with no overlap thou. Customer retention is a key factor in maintaining strong profit margins.

Given the density and presence of mobile operators, the mobile strategy has been driven by Mobile Virtual Network operations, through the deployment of quadruple play packages.

24.2.3 Portugal

The Portuguese market is marked by a high concentration of double play subscribers and a mature telecommunications market, which, when coupled with slow economic recovery, makes it difficult to achieve revenue growth. This market is marked by high subscriber attrition and downward migration from high to low ARPU offers.

The challenge in Portugal is to maintain a subscriber base and migrate the customer base from double play to triple play offers.

24.2.4 French Overseas Territories

The French Overseas Territories present growth opportunities with relatively limited competition and room to attract more subscribers on our cable infrastructure. Additional growth potential exists notably through the deployment of multiple-play services and efficiency gains in distribution network, , as multiple-play packages penetration remains low. Price pressure is low in these regions and customers are willing to pay more for value added services.

Additional opportunities have been identified and pursued in the e-banking sector.

Altice VII S.à r.l.

Consolidated financial statements as of December 31, 2013 (Continued)

24—Segment analysis (Continued)

24.3 Segment information

Details regarding revenues, cost of sales and gross profit for our cable, mobile and other segments are as follows:

	December 31, 2013					
	Total	Belgium & Luxembourg	Israel	French Overseas Territories	Portugal	Others
	(in millions of euros)					
Cable						
Revenue	891.9	61.8	694.2	27.1	108.7	—
Costs of sales	(179.5)	(10.6)	(129.6)	(5.0)	(34.1)	—
Gross Profit	712.3	51.0	564.6	22.1	74.6	—
Mobile						
Revenue	256.2	1.2	187.6	67.3	—	—
Costs of sales	(129.9)	(0.9)	(107.8)	(21.2)	—	—
Gross Profit	126.4	0.3	79.8	46.1	—	—
B2B and others						
Revenue	138,6	8.9	—	32.5	41.8	55,3
Costs of sales	(58.4)	(1.0)	—	(10.9)	(24.3)	(22.1)
Gross Profit	80.2	7.8	—	21.6	17.5	33.2
Total						
Total Revenue	1,286.7	72.0	881.8	126.9	150.5	55.3
Total Costs of sales	(367.8)	(12.9)	(237.4)	(36.9)	(58.4)	(22.1)
Total Gross Profit	918.9	59.1	644.4	89.8	92.1	33.2
Operating expenses	(400.2)	(12.9)	(281.7)	(40.5)	(43.0)	(22.0)
Depreciation and amortisation	(399.6)	(18.1)	(274.9)	(26.6)	(65.1)	(14.8)
Other operating income & expenses . .	(76.8)	(4.2)	(57.4)	(9.5)	(10.7)	5.0
Operating income	42.3	23.8	30.4	13.3	(26.8)	1.5

Altice VII S.à r.l.

Consolidated financial statements as of December 31, 2013 (Continued)

24—Segment analysis (Continued)

	December 31, 2012					Others
	Total	Belgium & Luxembourg	Israel	French Overseas Territories	Portugal	
	(in millions of euros)					
Cable						
Revenue	873.3	70.3	677.9	24.4	98.2	2.5
Costs of sales	(212.9)	(10.3)	(159.0)	(4.1)	(39.1)	(0.5)
Gross Profit	660.4	60.0	518.9	20.4	59.1	2.0
Mobile						
Revenue	172.7	0.2	172.5	—	—	—
Costs of sales	(69.9)	(0.1)	(69.8)	—	—	—
Gross Profit	102.8	0.1	102.7	—	—	—
B2B and others						
Revenue	46.4	0.8	—	—	—	45.6
Costs of sales	(19.3)	(0.6)	—	—	—	(18.7)
Gross Profit	27.1	0.2	—	—	—	26.9
Total						
Total Revenue	1.092.4	71.3	850.4	24.4	98.2	48.1
Total Costs of sales	(302.1)	(11.0)	(228.8)	(4.1)	(39.1)	(19.2)
Total Gross Profit	790.3	60.3	621.7	20.4	59.1	28.9

25—Operating expenses

	December 31, 2013	December 31, 2012
	(in millions of euros)	
Technical and maintenance costs	(149.0)	(141.9)
Customer services	(32.9)	(18.3)
Taxes	(3.6)	(2.4)
Total	(185.4)	(162.5)

26—Depreciation, amortization and goodwill impairment

It consists in (i) amortization of intangible assets for a total of EUR 133.4 million (2012: EUR 245.7 million including EUR 121.9 million of goodwill impairment), (ii) depreciation of tangible assets for a total of EUR 251.4 (2012: EUR: 219.6 million) and (iii) other additions and reversals for a total of EUR 14.8 million (mainly representing additional depreciation on inventories and receivables) (2012: EUR 77.10 million, representing a net reversal for the year).

Altice VII S.à r.l.
Consolidated financial statements as of December 31, 2013 (Continued)

27—Other operating incomes and expenses

	December 31, 2013	December 31, 2012
	(in millions of euros)	
Other incomes and expenses	(17,0)	(24.9)
Other revenues	0.9	—
Disposal of tangible assets	1.0	(4.8)
Other expenses, net	(15.1)	(29.8)
Non-recurring costs ⁽¹⁾	(58.3)	(22.4)
Restructuring costs ⁽²⁾	(2.9)	(6.7)
Restructuring and other non-recurring costs	(61.2)	(20.8)
Total	<u>(76.3)</u>	<u>(50.5)</u>

- (1) The increase of non-recurring costs is mainly explained by a one-off EUR 31.6 million charge booked at HOT Mobile concerning the entering into a new network sharing agreement with Partner Telecommunication and the termination of the existing agreement with Pelephone. The provision relates to any cost overlap resulting from the use of Pelephone's network during the transition phase. In addition, Altice financing incurred costs related to consultants' fees and other outlays related to the acquisition of OMT Invest S.A.S and Winreason S.A.
- (2) Restructuring costs decreased in the year ended December 31, 2013 as a result of the completion of restructuring at Cabovisao. The charge of EUR 2.9 million refers to the restructuring costs engaged at ONI telecom since its acquisition in august 2012.

28—Net finance costs

	December 31, 2013	December 31, 2012
	(in millions of euros)	
Gain arising on fair value of financial instruments ⁽¹⁾	0.1	0.5
Foreign exchange gains	91.0	24.7
Gain arising from fair value of subordinated financial instruments ⁽¹⁾	2.5	0.9
Finance income	93.6	26.1
Interest charges on borrowings and overdrafts ⁽²⁾	(199.2)	(118.5)
Loss arising on fair value of financial instruments	(99.4)	(62.8)
Foreign exchange losses	(24.5)	(2.8)
Net book-value of disposal/financial assets	(13.6)	(16.7)
Finance costs	(336.8)	(200.0)
Total	<u>(243.2)</u>	<u>(174.1)</u>

- (1) Gains arising on fair value variations of financial and subordinated financial instruments issued by the Company for a total amount of EUR 1.4 million and a gain on interest rate swaps recorded at Altice financing for a total amount of EUR 1.3 million.
- (2) The increase in interest expense for the year ended December 31, 2013 was primarily due to (i) the issuance of new debt to finance the Outremer Telecom and ONI transactions (€12.9 million impact in 2013) and (ii) the full year impact of the debt incurred to finance the HOT take private in 2012 (€47.45 million in 2013).

29—Transactions with non-controlling interests

On April 23, 2013, the company repurchased the 40% minority interests held by Apax in its Portuguese subsidiary, Cabovisao for a total consideration of EUR 105.0 million, of which EUR 90.0 million was paid as consideration for equity acquired and EUR 15.0 million used in the repayment of a shareholder loan. The total amount of equity acquired was valued at EUR 13.1 million and the impact on the net equity of the Group was EUR 77.0 million following the consummation of the deal.

On November 29, 2013, the company repurchased the 40% minority interests held by Apax through its holding company Codilink S.à r.l. in Coditel Holding Lux and Coditel Management. The total

Altice VII S.à r.l.

Consolidated financial statements as of December 31, 2013 (Continued)

29—Transactions with non-controlling interests (Continued)

consideration paid was EUR 82.5 million, of which EUR 30.6 million was paid to acquire shares in Coditel Holding Lux II and EUR 51.9 paid to reimburse subordinated debt instruments (CPECs) held by the minority shareholder. The amount of equity acquired by the Group was valued at EUR 1.7 million, with a total impact of EUR 28.9 on the Group net equity following the consummation of the deal.

30—Average workforce

	December 31, 2013	December 31, 2012
Managers	352	268
Technicians	857	660
Employees	<u>3,011</u>	<u>4,719</u>
	<u>4,220</u>	<u>5,647</u>

31—Transaction with related parties

31.1 Trading and financial transaction

Transactions with related parties mainly related to transactions with Numericable Group, Next L.P. or Altice Six S.A.. Such transactions are limited to (i) re-invoicing of certain operational services granted by Numericable Group to certain subsidiaries of Altice VII, or (ii) shareholder preferred equity certificates or loan issued by Altice VII and held by Next L.P.

Transaction with related parties that directly impact the reserves of the Group are summarized in note 13.

Other related parties include consulting firms specialized in the management and operations of telecom companies and executive managers of Altice VII. The fees paid to the consulting companies include recurring fees paid based on service level agreements established with Altice VII, one-off success fees for the successful completion of acquisitions or negotiations with banks on debt contracts/bond issuance and reimbursement of any outlays and expenditures incurred by the employees of these companies when working on behalf of Altice VII. Transactions with executive managers include loans provided to them by the Company.

Consolidated Income and expenses	Revenue		Operating expenses		Financial expenses	
	December 31, 2012	December 31, 2013	December 31, 2012	December 31, 2013	December 31, 2012	December 31, 2013
	(In millions of euros)					
Equity holders	0.2	0.1	12.1	0.2	—	0.6
Executive managers	—	—	—	—	—	—
Remuneration and benefits in kind	—	—	2.5	—	—	—
Associate companies	—	<u>0.1</u>	—	<u>0.7</u>	—	<u>6.2</u>
TOTAL	<u>0.2</u>	<u>0.2</u>	<u>14.6</u>	<u>0.9</u>	<u>—</u>	<u>6.8</u>

Assets	Loans and receivables		Trade accounts receivable and other		Current accounts	
	December 31, 2012	December 31, 2013	December 31, 2012	December 31, 2013	December 31, 2012	December 31, 2013
	(In millions of euros)					
Equity holders	—	—	—	0.2	—	—
Executive managers	2.7	—	—	—	—	—
Associate companies	—	—	—	<u>0.8</u>	—	—
TOTAL	<u>2.7</u>	<u>0.0</u>	<u>—</u>	<u>1.0</u>	<u>—</u>	<u>—</u>

Altice VII S.à r.l.
Consolidated financial statements as of December 31, 2013 (Continued)

31—Transaction with related parties (Continued)

Liabilities	Other financial liabilities		Trade accounts payable and other		Current accounts	
	December 31, 2012	December 31, 2013	December 31, 2012	December 31, 2013	December 31, 2012	December 31, 2013
	(In millions of euros)					
Equity holders	109.0	99.2	1.6	—	0.6	—
Executive managers	—	—	—	—	—	—
Associate companies	—	—	—	6.6	—	—
TOTAL	109.0	99.2	1.6	6.6	0.6	—

31.2 Compensation of key management personnel

The compensation given to the managers, in respect of their duties as Chairman of the Executive Board or member of the Executive Board of Altice S.A. for the financial year 2013, is EUR 2.3 million compared to EUR 1.7 million for the financial year 2012.

The remuneration of directors and other members of key management personnel during the year was as follows:

	December 31, 2013	December 31, 2012
Short-term benefits	2.3	1.7
Post-employment benefits	—	—
Other long-term benefits	—	—
Share-based payments	—	—
Termination benefits	—	—
TOTAL	2.3	1.7

32—Contractual obligations and commercial commitments

The Group has contractual obligations to various suppliers, customers and financial institutions that are summarized below. A detailed breakdown by operating entity is provided below.

Unrecognised contractual commitments	December 31, 2013					Total
	< 1 year	Between 1 and 2 years	Between 2 and 3 years	Between 3 and 4 years	Five years or more	
Good and service purchase commitments	103.4	70.0	36.0	1.4	21.9	232.7
Investment commitments	38.9	1.2	.6	—	—	40.7
Guarantees given to suppliers/customers	5.8	2.7	2.3	2.3	1.2	14.3
Guarantees given to government agencies	14.1	7.5	.5	4.0	22.3	48.3
Other commitments	(2.1)	51.5	—	—	—	49.4
Total	160.1	132.9	39.3	7.7	45.4	385.3

32.1 Hot Telecom Commitments

32.1.1 Commitments

A. Contingent liabilities

1. Within the framework of the merger of the cable companies on December 31, 2006, HOT Telecom (or “HOT”) assumed responsibility for the existing claims in the field of activity of the acquired companies (the cable companies in their former format), furthermore, it was determined that the

32—Contractual obligations and commercial commitments (Continued)

company would assume responsibility for any claim that might be filed in the interim period by any of the acquired companies after the time of the completion of the merger of the cable companies.

In addition, HOT has entered into a commitment under an indemnification agreement with each of the three previous holders of the rights in the HOT Gold Partnership (the Tevel Group, the Yedioth Communications and the Fishman Group) in accordance with which the company has undertaken to fully indemnify the partners in the HOT Gold Partnership, prior to the completion of the merger transaction, so that they will be released from all responsibility, commitment or debt of any sort whatsoever that HOT Gold had on December 31, 2006 or that HOT Gold might have had after that date, and which relate to the period prior to the completion of the merger, including in respect of claims and legal proceedings.

2. Lawsuits have been filed and are pending against companies in the Group in the routine course of business and various legal proceedings are outstanding against it (hereinafter—Lawsuits).

In the opinion of the managements of the Group companies, based, inter alia, on legal opinions in respect of the chances of the lawsuits, appropriate provisions have been recorded in the financial statements as of December 31, 2013 in an amount of EUR 11.1 million, were provisions are required, to cover the exposure in respect of the said lawsuits.

In the opinion of the management of the Group companies the additional exposure in an amount of approximately EUR 565 million (over and above the provisions that have been recorded in these financial statements), as of December 31, 2013 in respect of lawsuits that have been filed against companies in the Group on various issues is as follows:

- a) An amount of approximately EUR 377 Million in respect of claims, the chances of which, in the assessment of the company's management, in reliance on opinions from its legal advisors, do not exceed 50%.
- b) An amount of approximately EUR 105 Million in respect of claims, which it is not possible to evaluate at this stage, and which consist primarily of applications for approval as class actions that were filed shortly before the date of the financial statements.
- c) An amount of approximately EUR 84 Million in respect of claims, where the chances of there being accepted in the assessment of the HOT's management, in reliance on the opinion of its legal advisers, exceed 50%.

Altice VII S.à r.l.

Consolidated financial statements as of December 31, 2013 (Continued)

32—Contractual obligations and commercial commitments (Continued)

The following table is an abbreviated summary of the Group's contingent liabilities, which are outstanding as of December 31, 2013, according to groupings having similar characteristics:

The subject matter of the lawsuit	Amount of the additional exposure over and above the provision as of December 31, 2013	Amount of the lawsuits that it is not possible to assess, which were presented shortly before the date of the financial statements (primarily applications for approval as class actions)	Provision recorded in the financial statements as of December 31, 2013	Provision recorded in the financial statements as of December 31, 2012	Updating of the expense (income) in the reporting period
	EUR in Million				
Customers ⁽¹⁾	490.0	82.0	4.2	2.1	2.1
Copyright	—	—	6.3	11.3	0.4
Suppliers ⁽²⁾	22.6	11.3	0.4	0.6	—
Employees	1.0	—	0.2	0.2	—
The merger transaction . .	50.2	—	—	—	—
Total	563.8	93.3	11.1	14.2	2.5

(1) The amount includes EUR 10.5 Million in respect of claims after the balance sheet date.

(2) The amount includes EUR 9.4 Million in respect of claims after the balance sheet date.

B. Commitments

1. Royalties to the Ministry of Communications and other payments to the government

a) HOT Telecom used to be committed to pay annual royalties in accordance with the Telecommunications Regulations (Concessions)—1987. In accordance with the Telecommunications Regulations (Telecommunications and Broadcasting) (Royalties)—2001, HOT Telecom is required to pay annual royalties in respect of its income from in country operator services and HOT Mobile is required to pay annual royalties in respect of its radio telephone services (less payments to another license holder in respect of reciprocal connection or roaming services). The royalties rates that HOT Telecom and HOT Mobile have each been charged to pay stood at 1.75% in 2012 and decreased to 0% from 2013 onwards.

b) In July 2001, the cables companies, including HOT Telecom, entered into a commitment under an agreement with the State of Israel on the subject of a solution to the disputes between the cable companies and the State in respect of the right of each company to operate the existing cables infrastructure in each of the concession areas after the end of the period of the concessions. It was stipulated in the agreement that the State undertakes to waive all of its claims and its rights in respect of the cables infrastructure such that each cables company would be the owner of all of the rights, including property rights, in the cables infrastructure that it held in the area of its concession and that it would have available to it the right to continue to operate it even at the end of the concession period. In consideration for this, it was stipulated that each company was to pay to the State, on an annual basis and for a period of 12 years (commencing on January 1, 2003), its relative share, as determined in the agreement, of an amount that is equivalent to the multiple of certain incomes (as determined in the agreement) of each of the cable companies on a graduated scale (in accordance with the level of income, as aforesaid) at a rate of from 0% to 4%. The relative share of each company can be altered by agreement between the cables companies.

In addition, it was stipulated that each company is to pay approximately 12% of the overall consideration from the sale of operations that are executed through the cables infrastructure for a period of 12 years. It was also stipulated in the agreement that in so far as HOT has received any amount whatsoever in consideration for the issuance of its shares to the public or to an external investor or in consideration for

32—Contractual obligations and commercial commitments (Continued)

the sale of shares of another company from among the cables companies, part of the consideration from the issue or the sale, as aforesaid, is to serve as an advance payment for the payment of the relevant portion of the consideration that remains to be paid under the agreement, in accordance with a formula that will be determined by the parties by agreement. It is further stipulated in the agreement that it shall apply to the cables companies or to any company that is split or merged even if structural changes are made of any sort whatsoever, and accordingly, with the completion of the merger, the agreement applies to HOT as a merged company.

c) In accordance with the Wireless Telegraph Regulations (Licensing, Certification and Levies)—1978, HOT Mobile is required to pay a fixed annual payment for each frequency that it uses. HOT Mobile paid amounts of EUR 6.1 million and EUR 5.4 million in respect of the years 2013 and 2012 respectively.

2. Other royalties

a) Within the framework of the Group's routine operations in the broadcasting field, the Group enters into commitments under arrangements and agreements under which the Group pays royalties to various authors' organizations. The amounts of the royalties that have been reflected by the Group within this context in the years 2013 and 2012 amounted to EUR 9.4 million and EUR 8.8 million respectively.

b) On January 30, 2012 a draft of the Authors and Performers Law (Judgment on Royalties Issues) 2012 (hereinafter, in this section—"The draft law") was placed before the Knesset. The draft law was intended to create a royalties court by empowering one of the District Court Judges to hear cases on royalties issues, royalty rates and disputes in royalty issues (in other words, a dispute on the issue of royalty rates between a collective management entity and a user or users of a repertoire).

This draft, if it is accepted, may have an implication for the issue of the payment of royalties to various organizations. As of the date of this report, HOT is unable to assess what the impact of the said legislation will be on its business results, if it is passed.

3. A commitment to invest in original productions

In accordance with the provisions of the Communications Law, the principles of communications and decisions by the Council, HOT is required, inter alia, to invest amounts in original productions at a rate of 8% of its annual income from subscription fees. During the course of the years 2012 and 2013 HOT complied with the investment rate that is required, as aforesaid.

It should be noted in this connection that the Communications Law has empowered the Council to determine the rate of investment that is required, and solely that it may not exceed 12% and may not fall below 8% of the annual income from subscriber fees. In this connection, in October 2011 the Council informed HOT that as from the year 2012 its income from subscriber fees, which form the basis for the calculation for the requirement to invest in original productions, will be deemed to include all of the payments that are paid by its subscribers in order to receive broadcasts and to receive services, including income from users' terminal equipment and the installation thereof, whereas in accordance with the policy adopted by the Council up to them regarding the inclusion of income from terminal equipment for the purpose of the calculation of the requirement for original productions was made conditional upon a mechanism that was based on the profitability of this income, and in past years the income from users' terminal equipment and the installation thereof was not included in the basis for the calculation for original productions. On January 12, 2012, the Council determined that HOT will be entitled to complete the amount of the additional investment for the year 2012 over three investment years.

4. Agreement to deploy and maintain a cables network

On January 1, 1990 and on May 1, 1989, Tevel International Transmission for Israel Ltd. and HOT Gold & Co. (hereinafter together—The cable companies) entered into commitments under agreements for the provision of planning, installation and maintenance services of the cables network with the Bezeq

32—Contractual obligations and commercial commitments (Continued)

company (the provisions of both of the two said agreements are similar, and they will hereinafter in this section be called—the agreement). This agreement was endorsed to HOT Telecom as part of the merger agreement.

In accordance with the agreement, Bezeq, Tevel and HOT Gold planned the cables network, inter alia, based on the Bezeq company’s available infrastructure, which was deployed in the areas of the concession at the time of the signing of the agreement. Tevel and HOT Gold supplied the Bezeq company with the base equipment (as defined in the agreement) that comprises the cables network whereas the Bezeq company supplied the additional equipment (as defined in the agreement) that is used for setting up the cables network.

In accordance with the agreement, a cables network was set up and deployed in a number of major cities across Israel, and the Bezeq company conducts the routine maintenance of the cables network and also provides malfunction repair services. The provisions of the agreement also relate, inter alia, to the possibility of the expansion of the cables network to additional facilities, the connection of new houses and of new neighborhoods.

It is determined in the agreement that it will remain in force for the length of the period of the concession, and that it will continue to be in force if the concession or the rights in the concession are transferred or afforded to another, in whole or in part and directly or indirectly, during the course of the original concession period and during the extension of that period or after the end of it. The Bezeq company is only entitled to cancel the agreement in respect of a breach for which notice has been given in writing.

The total of the expenses recorded in HOT’s accounting records for the network services payable to the Bezeq company in the years 2013 and 2012 amounted to EUR 9.8 million and EUR 10 million, respectively.

It should be noted that from time to time, during the routine course of business, disputes arise in connection with the implementation of the agreement, inter alia in respect of the division of the costs that are involved in the performance of some of the services that are supplied by the Bezeq company under the agreement, however the parties are continuing to operate in accordance with the agreement. It is further noted that over the course of the years additions have been signed to the agreement, primarily in connection with enhancement and upgrading work on the cables network.

5. Commitments to lease assets

The Group has commitments under agreements for the leasing of buildings and motor vehicles for various periods up to the end of the year 2020. The minimal future rental fees in respect of the rental contracts as of December 31, 2013, exclusive of the option period, are as follows:

	<u>EUR Million</u> <u>December 31, 2013</u>	<u>EUR Million</u> <u>December 31, 2012</u>
2014	37.3	37.8
2015	30.2	30.0
2016	19.7	24.4
2017	10.1	17.5
2018 and thereafter	7.3	61.7
	<u>104.6</u>	<u>171.3</u>

6. On July 19, 2011, HOT’s Board of Directors approved a commitment under agreements for the execution of the upgrading of the fiber optic infrastructure (FTTX). In accordance with the said commitment, HOT Telecom will purchase advanced optic equipment, work and services from third parties, in order to upgrade the infrastructures, including maintenance services, in accordance with the deployment and the timetables that will be agreed upon between the parties from time to time. The upgrading of the infrastructure, as aforesaid, will enable the expansion of the traffic capacity on the network, in favor of the supply of enhanced VOD services, the increasing of the number of channels that the Group can offer to its subscribers, faster internet services and it will also enable HOT to deal with increased demand for traffic capacity on the network in the future, which is expected to arise as a result of increased uses and applications that require a considerable band width.

32—Contractual obligations and commercial commitments (Continued)

7. On May 27, 2010, a facility agreement was signed between HOT Mobile and Motorola for the purchase, licensing and installation of the infrastructure equipment (hardware and software) which is required in order to operate HOT Mobile's iDEN network. The agreement is in force for a period of five years from the time that it was signed (hereinafter -the initial period) and it will be renewed for additional periods of one year each (or for a longer period that is agreed between the parties), unless a party to the agreement gives notice to the other party, 90 days before the end of the initial period, or one of the extension periods, as the case may be, of its desire to terminate the commitment. The agreement arranged the commitment between the parties for the purpose of the execution of the work orders that will be presented to Motorola, from time to time, by HOT Mobile for the purpose of the supply of equipment or software for the iDEN network.

Within the framework of the agreement, Motorola has undertaken that during the initial period it will hold an inventory of equipment that will enable it to immediately supply the components that are required for the proper functioning of HOT Mobile's iDEN network, and so that it will be capable of supplying HOT Mobile with the maintenance services for the infrastructure equipment and the software that are required to operate the network for a period of seven years from the signing of the agreement, subject to the purchase of the said maintenance services by HOT Mobile.

In consideration for Motorola's commitment to sell the equipment and the licenses to HOT Mobile at the prices that are denoted in the agreement, HOT Mobile has made a commitment to purchase the infrastructure equipment and the software that is required to operate the iDEN network from Motorola alone during the period of the agreement.

8. As part of the commitment with Motorola in respect of the infrastructure for the iDEN network, HOT Mobile has signed on a system maintenance agreement with Motorola as well as on an agreement for the maintenance of the system's hardware, which arrange the repair of malfunctions and the provision of support by Motorola for HOT Mobile's iDEN network.

In December 2011, the system maintenance agreement was extended for an additional period of three years, until the end of 2014.

9. On May 26, 2010, as part of the sale of the control in HOT Mobile to Altice, HOT Mobile entered into a commitment under an agreement with Mobility for the purchase of terminal equipment that supports the iDEN technology.

The agreement is in force for a period of 5 years and it will be renewed for additional periods of one year each time unless a party to the agreement gives notice to the other party, 60 days before the end of the initial period, or one of the extension periods, as the case may be, of its desire to terminate the commitment.

The agreement arranged a mechanism for the ordering and supply of the terminal equipment (including quarterly forecasts by HOT Mobile) with HOT Mobile being responsible for the importing of the terminal equipment from abroad.

The supplier has received an option and the right of first refusal for the repurchase from HOT Mobile of all of the terminal equipment that it may be holding at the time of the termination of the agreement, in accordance with a mechanism that was set in the agreement.

10. On June 16, 2011, HOT Mobile entered into a commitment with Nokia Siemens Networks Israel Ltd. (hereinafter—the supplier) for the setting up of the infrastructure for HOT Mobile's new network.

In accordance with the terms of the agreement, the supplier will plan and set up the new network for HOT Mobile as a turnkey contractor. In the first stage, which was completed in May 2012, the supplier completed the setting up of the systems that are required for the purpose of operating the new system with a coverage of approximately 30%, which is in excess of the extent of the coverage which HOT Mobile is required to provide (20%) in accordance with the terms of the tender within two years from the time of the receipt of the new radio telephone license. After the completion of the first stage, HOT Mobile

32—Contractual obligations and commercial commitments (Continued)

has expanded and is expanding the new network, both from the perspective of the coverage and also from the perspective of the LTE capability.

The agreement is in force for 15 years, and it contains warranties for the proper functioning of the components of the system for a period of two years from the time of the handing over of each component in accordance with the agreement, as well as warranties for the entire period of the agreement that the system will operate in accordance with the system requirements that HOT Mobile placed (in terms of availability, functioning and capacity), subject to their being a maintenance agreement in force between the parties.

In consideration for the completion of the first, second and third stages in accordance with the agreement and the performance of all of the supplier's commitments by the year 2013, the Group will pay the supplier an amount of 52 million Dollars, which amount does not include the expansion of the coverage and the capacity over and beyond what is stipulated in the agreement.

11. In 2013 and at the beginning of 2014, a number of additions to the agreement were signed, within the framework of which the payments that were supposed to be paid under the agreement have been deferred to a later date, subject to HOT Mobile's signing on debt notes, with Hot acting as guarantor. Within this framework, HOT Mobile has signed on confirmation for the final receipt of significant portions of the said project.

12. On October 27, 2011, an agreement was signed between HOT Mobile and Comverse Ltd. (hereinafter—Comverse), in accordance with which Comverse will supply HOT with a BSS system (a billing system that is integrated with the customer relations management (CRM) system) (hereinafter—The system) and Comverse will also supply HOT with hardware, software and services, including the operation and maintenance of the system. The agreement is for a period of five years. In consideration for Comverse's services, HOT Mobile will pay an amount of approximately 12.5 million US Dollars. In January 2012, the parties signed on an addendum to this agreement, in accordance with which Comverse is committed to allocate seven additional employees to be available for the project (instead of the manpower that HOT had to make available for the project), for a payment of 500,000 US Dollars.

13. On May 30, 2012, HOT Mobile International Communications Ltd (hereinafter—HOT International), a wholly owned subsidiary of HOT Mobile's, received an operator's license for the provision of international telecommunications services (hereinafter—The international license). On January 6, 2013 HOT International received operational approval for starting to provide international telecommunications services in accordance with the international license and on January 8, 2013, notification of the opening of the services was sent to all of the operators.

14. On November 11, 2013, HOT's Audit Committee approved HOT's commitment under a sub-leasing agreement with the Middle East Company Ltd. (hereinafter—the lessor) for the sub-leasing of a plot of land in the Jaffa Port, which HOT is leasing (hereinafter—the leased property), retroactively, as from July 2013.

The leased property will be used by the tenant, which is a company that produces broadcasts for a foreign news company, which is 85% owned by Mr. Patrick Drahi, the ultimate controlling interest in HOT.

The lease fees that will be paid to HOT in respect of the leased property have been set in accordance with the rental fees that HOT pays in respect of the property and under the same payment terms (back to back), with the addition of a monthly amount in respect of: (1) the tenant's relative share of the municipal taxes, electricity, water, security and cleaning expenses (back to back terms to those paid by HOT) and (2) adaptations to the leased property that HOT has executed at its own expense.

It is determined in the rental agreement that in any case in which the agreement ends before the end of the rental period, the tenant shall pay HOT the balance of the payments in respect of the adaptations that HOT made in the leased property, as discounted using a real annual interest rate that has been set in the agreement.

32—Contractual obligations and commercial commitments (Continued)

15. On November 8, 2013, HOT Mobile signed on agreements with Partner Communications Ltd. (hereinafter—Partner), which are subject to the receipt of all of the approvals that are required, as detailed below: HOT Mobile and Partner will set up a limited partnership, which will hold, develop and operate a single advanced cellular communications network, for both of the companies, each of which will hold half of the rights in it. In accordance with the agreement, each of the parties will continue to hold and to operate its core of the network separately and provide cellular communications services, including the marketing and the selling of such services, to its customers alone.

The agreement arranges the management of the joint network and its development, the manner of the management of the partnership, including a mechanism for the appointment of a board of directors, the resolution of disagreements, the bearing of the costs of upgrading the network and so on.

The agreement will be in force for a period up to December 31, 2028, and thereafter, the agreement will be extended automatically for additional periods of 5 years each, unless either of the parties gives notice of its desire to terminate the agreement by giving notice in advance of 24 months before each automatic renewal. Despite the aforesaid, as from the end of a period of 8 years from the entry of the agreement into force, it may be cancelled by either of the parties, in accordance with their own judgment and by giving two years notice in advance from that time. The agreement also sets a mechanism for the separating of the parties in the event of the termination of the agreement.

In consideration for the agreement, HOT Mobile will pay a non-recurring amount, which is to be paid by the beginning of 2017, and thereafter, each party will bear half of the capital investments that are required to set up and to upgrade the joint network and the bearing of the operating expenses for the joint network will be in accordance with a mechanism that is set in the agreement and which is based, inter alia, on the volume of the data traffic that each party consumes from the joint network.

As an interim stage and until the receipt of the approvals that are required under the law, Partner will extend to HOT Mobile the right to use its cellular communications network for the purposes of the provision of brad national cover to its customers. The services under the agreement will apply after the completion of the preparations and in accordance with any agreement or regulation.

In the light of the commitment with Partner in connection with the in-country roaming services, HOT Mobile and Pelephone Telecommunications Ltd. (with which HOT Mobile had entered into an exclusive agreement in the past for in-country roaming services up to December 31, 2014) reached agreement regarding the cancellation of the exclusivity clause.

16. In the reporting period, the management of HOT Mobile Ltd. (hereinafter—HOT Mobile), made a decision regarding the vacation of its offices at Airport City, in respect of which there is a long-term rental contract with Airport City, for the period up to and including 2019. As a result of this decision, HOT has recognized losses of EUR 7.1 million in the reporting period, which have been recorded under other expenses, reflecting the rental expenses, taxes and amortization of leasehold improvements, which in HOT Mobile's assessment are irrecoverable, and which meet the definition of an onerous contract.

17. Capitalized leasing rights on land from the Israel Lands Authority

Capitalized leasing rights on land from the Israel Lands Authority over an area of 20,713 square meters on which the Group's buildings are located. The amount that is attributed to the capitalized rights is presented as a prepaid expenses in respect of operating leases in the balance sheet and is amortized over the period of the leases. See also Note 2K. The lease periods end in the years 2021-2045.

C. Guarantees and liens

1. As collateral for HOT's commitments vis-à-vis the parent company under the credit agreement with it, the following charges have been placed

- a) A floating charge on HOT's assets.
- b) A fixed charge on the shares in the subsidiary companies.

32—Contractual obligations and commercial commitments (Continued)

- c) HOT Telecom has given a charge on some of its assets.

The said charges are in an unlimited amount, vis-à-vis HOT, the investee partnership—HOT Telecom and the subsidiary company—HOT Net, jointly and severally.

2. As collateral for the commitments of HOT, the investee partnership HOT Telecom and the subsidiary company HOT Net, first ranking floating charges have been placed in unlimited amounts in favor of the borrowers, on all of the assets and the rights belonging to debtors of companies in the Group and a fixed charge on the goodwill and the unpaid share capital of the Companies in the Group.

3. As collateral for HOT's commitments in respect of the royalties agreement, as set forth in section B(1) above, a second ranking floating charge has been placed in favor of the State.

4. As collateral for the Group's commitments, as determined in the Group's licenses and in the decisions by the Director and the Council, the Group has issued a number of guarantees, as follows:

a) Bank guarantees to the Ministry of Communications, in respect of the national operator license that was granted to HOT Telecom amounting to 8.4 million Dollars, in force until December 2017 and December 2025.

b) Guarantees in an amount of EUR 7.1 million (index-linked) to the Council in respect of the broadcasting license, which are in force until May 2015.

5. HOT has given a number of bank guarantees to various bodies in an overall amount of EUR 6.7 million.

6. Guarantees for HOT Telecom and HOT Mobile

a) The Group has extended guarantees in a cumulative amount of 22 million Dollars as collateral for payments by HOT Telecom to the Cisco company.

b) The Group has extended a guarantee in an amount of EUR 51.5 million (index-linked) as collateral for HOT Telecom's commitments vis-à-vis an interested party with which it has signed a rental agreement.

c) The Group has extended a guarantee in an amount of 36 million Dollars as collateral for HOT Mobile's commitments to Bank Crédit Agricole in connection with transactions with suppliers of equipment.

d) The Group has extended a guarantee in an amount of EUR 2.3 million as collateral for the commitments of HOT Telecom to various bodies.

7. On May 23, 2013, HOT signed on a credit agreement with Bank Discount Le'Israel Ltd., the First International Bank Le'Israel Ltd. and HSBC Bank PLC (hereinafter—the banks and the credit agreement, respectively).

The amounts of the credit are divided into a number of facilities: A working capital facility, which may be exploited by the drawing down of loans in an amount of up to EUR 41.9 million and a credit facility for guarantees in an amount of up to EUR 22 million.

The collateral that exists under the financing agreement that HOT signed with Altice Financing S.A., which is a related party of HOT, will serve as collateral, together with the creation of new, additional liens on HOT's holdings in subsidiary companies and partnerships, except for HOT Mobile. As of the balance sheet date, HOT has taken up a guarantee in an amount of EUR 17.6 million from these facilities, however it has not taken up credit for working capital from these facilities.

32—Contractual obligations and commercial commitments (Continued)

32.2 Cabovisao commitments

32.2.1 Contingent assets

During the year ended December 31, 2013 and the analysis of the Decree-Law n^o 123/2009 of 21 May, Cabovisao made the decision not to pay any fees charged by municipalities, in addition to TMDP (Fees due for rights and charges related to the deployment of, passage within or crossing of systems, equipment and other resources of providers of publicly available electronic communications networks and services at a fixed location, of a public or private municipal domain). On December 31, 2013, Cabovisao had outstanding claims against several municipalities, totaling EUR 2.6 million. To present date, the Company received EUR 0.4 million from sixteen municipalities, and executed receivable plan of EUR 1.7 million for the next three years.

32.2.2 Contingent liabilities

a) Bank guarantees

	December 31, 2013
	In millions of euros
Tax Authority	9.6
City Council	0.9
Third Parties	<u>0.1</u>
Total	<u><u>10.6</u></u>

b) Commitments with third parties to add services to be provided in future years:

On December 31, 2013, the commitments with third parties to tangible assets and services to be provided in future years with an amount to approximately EUR 2.7 million Euros and EUR 65.7 million respectively.

c) Real guarantees:

During the year ended December 31, 2013, considering the refinancing and debt restructuring operations performed by Altice Group, headed by Altice VII S.à r.l., Cabovisao has signed a collateral agreement which involved the pledge of some Cabovisao's bank accounts, as well as a pledge on the Cabovisao's shares (representing 100% of Cabovisao's share capital and respective voting rights).

d) Other contingent liabilities:

As a result of the Cabovisao's decision to do not pay any taxes charged by municipalities (since September 2010), the municipality of Almada initiated a litigation process, regarding the municipality taxes charged for the period between 2006 and 2009, in the amount of EUR 595.000.. Until the present date, there are no subsequent deliberations. The Board of Managers understands that the final outcome will be favorable to Cabovisao, based on the legal counsels' opinion.

In addition, there are several legal proceedings, initiated by third parties, in particular claims by several suppliers, related to the supply of services and equipment, in the amount of approximately EUR 174.000. Until the present date, Cabovisao has not recognized any provision, since it is Board of Managers understanding that the final outcome will be favorable to the company, based on the legal counsels' opinion.

32—Contractual obligations and commercial commitments (Continued)

32.3 Coditel Holding commitments

As of December 31, 2013, off balance sheet commitments include:

The shares, bank accounts and receivables of Coditel Brabant S.p.r.l. and Coditel S.à r.l. have been pledged in the framework of the Coditel facility. Coditel Holding is not allowed to pledge these assets as security for other borrowings or to sell them to another entity.

32.4 Others

The shares, bank accounts and receivables of Altice VII and its following subsidiaries Altice Finco S.A., Altice Financing S.A., Altice Holdings S.à r.l., Altice West Europe S.à r.l., Altice Portugal S.A., Altice Carribean S. à r.l., Cool Holdings LTD S.A., H.Hadaros 2012 LTD., HOT Telecommunications System LTD, Cabovisao S.A., Altice Blue Two S.A.S. and its subsidiaries, Coditel Holding S.A., Winreason S.G.P.S and its subsidiaries have been pledged for the issued Senior Secured Notes and the Altice financing term loan. The Company is not allowed to pledge these assets as security for other borrowings or to sell them to another entity.

Altice financing has access to two super senior secured revolving credit facilities amounting to a total of USD 80 million and EUR 60 million respectively. In addition to these facilities, it also has access to a guarantee facility of EUR 75 million. As of December 31, 2013 the revolving credit facilities remain undrawn. EUR 8.4 million were drawn down on the guarantee facility, and recorded in the accounts of Cabovisao. All pledges applicable for the senior secured notes and the term loan are also applicable to these facilities.

33—Statutory Auditors' fees

In 2013, an amount of EUR 3.5 million was paid to various networks affiliates of the Group's auditors, split mainly between EUR 1.4 million for audit services, EUR 1.7 million for assurance services and EUR 0.4 million for non-audit services (tax and consultancy).

34—Going concern

During the financial year ended December 31, 2013, the company had a net current asset position of EUR 855.7 million (mainly due to current restricted cash of EUR 1,242.7 million), a net loss of EUR 208.3 million (down from a net loss of EUR 189.8 million in FY12), positive cash flow from operations of EUR 439.2 million and negative working capital of EUR 198.3 million. The positive cash flow from operations balance was mainly due to strong earnings growth and EBITDA generation. The net working capital of EUR 198.3 million is mainly driven by trade receivables and payables. The net loss recorded in FY13 was mainly driven by increased non-recurring expenses as compared to FY12 (+EUR 40.4 million) and increased financial expense, directly related to the issuance of new debt to finance acquisitions and buy back of minority stakes. The negative working capital position is structural and follows industry norms. Customers generally pay subscription revenues early or mid-month, with short DSOs (Days of Sales Outstanding) and suppliers are paid in the beginning of the following month, thus generating a negative working capital, as evidenced by the difference in the level of receivables and payables (EUR 194.0 million vs. EUR 392.3 million). Payables due the following month are covered by revenues and operating cash (if needed). As of December 31, 2013, the company had few short term loan payments (< 1y), and long term debt was refinanced in June 2013.

Despite the net current liability position, Management is of the view that the company will continue to act as a going concern for 12 months from the date of approval of these financial statements based on the following:

The Group has a strong track record of generating positive operating income before amortisation and depreciation and generated strong positive operating cash flows in 2013 (EUR 439.2 million). Operating income before D&A amounted to EUR 518.8 million, an increase of 28.7% compared to FY12, thus reaffirming management's ability to drive profits in the different operating companies.

34—Going concern (Continued)

The Group had healthy unrestricted cash reserves at the end of 2013 (EUR 61.3 million vs. EUR 129.7 million in 2012), which would allow it to cover any urgent cash needs. Additionally, the Group had access to a revolving credit facility (“RCF”) of up to USD 80.0 million and EUR 63.8 million (EUR 124 million equivalent), as well as access to a guarantee facility of up to EUR 75 million (of which EUR 8.4 million were drawn in FY2013 in order to unblock restricted cash at Cabovisao).

The Group had a negative net equity position of EUR 261.2 million as of December 31, 2013, resulting from accounting adjustments related to losses made on the acquisition of minority interests from non-controlling shareholders. It is management’s view that these acquisitions have a strategic founding and will allow the Group to better integrate, absorb and utilize the cash generated by the concerned entities.

In addition to the points enumerated above, the Group has implemented a new budgeting exercise, with monthly account reviews with CFOs of operating companies to track budget accuracy. This exercise is complemented by a mid-year reforecast based on real first semester numbers.

Management also tracks operational key performance indicators (KPIs) on a weekly basis, thus closely tracking top line trends very closely. This allows management and local CEOs to ensure proper alignment with budget targets and respond with speed and flexibility to counter any unexpected events and ensure that the budgeted targets are met.

In the view of the initial public offering of the newly formed company Altice S.A., the new direct controlling shareholder of Altice VII S.à r.l., it was decided to convert all existing subordinated debt instruments issued by Altice VII and subscribed by Next L.P., into share capital, before the contribution of Altice VII to Altice S.A. Thus, YPFECs and ALPECs issued by Altice VII were converted into equity at their nominal value, totalling EUR 133.3 million.

35—Events after the reporting period

Acquisition of the Mobius Group

On October 19, 2013, Altice Blue Two (a subsidiary of Altice VII) entered into an agreement pursuant to which Altice Blue Two will acquire the Mobius Group (the “Mobius Acquisition”). The Mobius Group is a telecommunications operator in the Overseas Territory of La Reunion, providing Internet access to professional clients under the “Mobius Technology” brand and double and triple play services based on xDSL technology to residential customers under the “IZI” brand. The consummation of the Mobius Acquisition is expected to occur on January 15, 2014. Pursuant to an investment agreement dated October 19, 2013, certain managers of the Mobius Group (the “Mobius Managers”) have agreed to reinvest a portion of the proceeds received from the Mobius Acquisition (approximately EUR 4.6 million) in Altice Blue Two. As a consequence of such reinvestment, the equity interest held by Altice Caribbean in Altice Blue Two would be reduced to approximately 77%. However, Altice Blue Two and the Mobius Managers are in advanced discussions to amend the existing investment agreement in order to provide that the Mobius Managers’ reinvestment will be made directly in Altice S.A., through the subscription by the Mobius Managers, at the Offer Price, of Ordinary Shares of Altice S.A..

The transaction was completed on January 15, 2014 and was financed via the super senior revolving credit facility that the company has access to. A total of EUR 20.5 million was drawn from the RCF to finance the acquisition.

Conversion of Altice VII subordinated debts

On January 31, 2014, Next L.P. converted all subordinated debt instruments held against Altice VII S.à r.l., before the planned initial public offering of Altice S.A., in exchange for common shares in the newly listed entity. All outstanding YPFECs and ALPECs issued by Altice VII were converted at their nominal value of EUR 133.2 million, which was directly attributed to the net equity of the company.

35—Events after the reporting period (Continued)

Initial public offering

On January 31, 2014, Altice S.A., a newly incorporated Luxembourg based entity and the new direct controlling shareholder of the Company, listed its shares in an initial public offering on Euronext Amsterdam.

Change in minority interests of Altice Blue Two

In January 2014, the Company entered into discussion with the management of Outremer Telecom (“OMT Managers”), holders of a 23% stake in Altice Blue Two, the holding company controlling Outremer Telecom, WSG and MTVC, to exchange their existing shares in Altice Blue Two S.A.S against shares in the newly floated mother company of Altice VII, Altice S.A.

As per the agreement, the OMT Managers will contribute all their shares held in Altice Blue Two and OMT Ocean 3 (an investment vehicle held by certain members of OMT’s senior management), for a base value of EUR 55.1 million and two separate earn out clauses that would become applicable only upon the achievement of certain operational and financial targets and the settlement of certain lawsuits.

The OMT managers will receive Altice S.A. common shares at the listing price at IPO (EUR 28.25), except in case of the second earn out, for which the determining price will be the share price at closing on the day on which any proceeds from the pending lawsuits are perceived by Altice Blue Two.

Acquisition of the Tricom Group

On March 12, 2014 the Group obtained control of Tricom S.A. and Global Interlink Ltd. (together, “Tricom”), a leading telecommunications operator in the Dominican Republic, providing (i) cable and xDSL-based multiple-play services and stand-alone pay television, broadband Internet and fixed-line telephony services and (ii) 3G and 4G mobile telephony services relying on its mobile network. This acquisition enables the Group to expand its footprint in the Carribean and more especially in the Dominican Republic. Control was obtained upon approval from Indotel, the Dominican Republic antitrust authority. As of the date of the transfer of the shares, the Group acquired 96% of the total equity in Tricom S.A. and 92% of the outstanding interests in Global Interlinks.

For the year ended December 31, 2013, Tricom would have contributed EUR 158.3 million to revenue and EUR 19.9 million to operating profit to the Group’s results, if it had been purchased on January 1, 2013 (these figures are based on unaudited US GAAP figures).

The following summarises certain of the major classes of consideration transferred and the provisionally determined amounts of identifiable assets and liabilities assumed at the acquisition date:

Total consideration paid to the vendors for the shares of Tricom amounted to €291.3 million, using the proceeds raised in December 2013.

The total value of assets transferred in consideration for the values mentioned above amounted to EUR 145.7 million, comprising mainly of intangible assets for a net value of EUR 21.0 million, property, plant and equipment for a total value of EUR 133.8 million and trade receivables for a total amount of EUR 16.5 million. Total liabilities amounted to €97.9 million, comprising of EUR 45.1 of non-current liabilities and EUR 52.8 million of current liabilities. The residual value of EUR 145.6 million was recognised provisionally as goodwill (these figures are based on unaudited US GAAP figures).

The values of the assets and liabilities assumed have been determined on a provisional basis until the Group finalizes its assessment of the fair valuation of the identifiable assets and liabilities assumed and shall complete this exercise within twelve months from the acquisition date.

Goodwill has been recognised as a result of the acquisition as follows:

Total consideration transferred	EUR291.3 million
Fair value of identifiable assets and liabilities	EUR(145.7) million
Goodwill	EUR145.6 million

ALTICE VII S.à r.l.

Société à responsabilité limitée

2012 Annual Report



REPORT OF THE REVISEUR D'ENTREPRISES AGREE

To the Partners of
Altice VII S.à r.l.
3, boulevard Royal
L-2449 Luxembourg
Grand-Duchy of Luxembourg

Report on the consolidated financial statements

Following our appointment by the Board of Managers, we have audited the accompanying consolidated financial statements of Altice VII S.à r.l., which comprise the consolidated statement of financial position as at December 31, 2012, and the consolidated statements of income, comprehensive income, changes in equity and cash flows for the year then ended, and a summary of significant accounting policies and other explanatory information.

Responsibility of the Board of Managers for the consolidated financial statements

The Board of Managers is responsible for the preparation and fair presentation of these consolidated financial statements in accordance with International Financial Reporting Standards as adopted in the European Union, and for such internal control as the Board of Managers determines is necessary to enable the preparation of consolidated financial statements that are free from material misstatement, whether due to fraud or error.

Responsibility of the réviseur d'entreprises agréé

Our responsibility is to express an opinion on these consolidated financial statements based on our audit. We conducted our audit in accordance with International Standards on Auditing as adopted for Luxembourg by the *Commission de Surveillance du Secteur Financier*. Those standards require that we comply with ethical requirements and plan and perform the audit to obtain reasonable assurance whether the consolidated financial statements are free from material misstatement.

An audit involves performing procedures to obtain audit evidence about the amounts and disclosures in the consolidated financial statements. The procedures selected depend on the *réviseur d'entreprises agréé's* judgement including the assessment of the risks of material misstatement of the consolidated financial statements, whether due to fraud or error. In making those risk assessments, the *réviseur d'entreprises agréé* considers internal control relevant to the entity's preparation and fair presentation of the consolidated financial statements in order to design audit procedures that are appropriate in the circumstances, but not for the purpose of expressing an opinion on the effectiveness of the entity's internal control. An audit also includes evaluating the appropriateness of accounting policies used and the reasonableness of accounting estimates made by the Board of Managers, as well as evaluating the overall presentation of the consolidated financial statements.

We believe that the audit evidence we have obtained is sufficient and appropriate to provide a basis for our audit opinion.

Opinion

In our opinion, the consolidated financial statements give a true and fair view of the consolidated financial position of Altice VII S.à r.l. as of December 31, 2012, and of its consolidated financial performance and cash flows for the year then ended in accordance with International Financial Reporting Standards as adopted in the European Union.

Report on other legal and regulatory requirements

The consolidated management report, which is the responsibility of the Board of Managers, is consistent with the consolidated financial statements.

For Deloitte Audit, *Cabinet de révision agréé*

John Psaila, *Réviseur d'entreprises agréé*
Partner

November 12, 2013

ALTICE VII S.À R.L.
Consolidated statement of income
Year ended December 31, 2012

	Notes	Year ended December 31, 2012	Year ended December 31, 2011
		(in millions of euros)	
Revenues	23	1 092,4	784,2
Purchases and subcontracting services	23	(302,1)	(175,4)
Other operating expenses	24	(248,9)	(195,4)
Staff costs and employee benefits expenses		(24,8)	(24,8)
General and administrative expenses	25	(33,3)	(26,4)
Other sales and marketing expenses		(80,1)	(64,4)
Operating profit before depreciation and amortization^(*)		403,2	297,8
Depreciation and amortization		(266,3)	(176,4)
Goodwill impairment		(121,9)	—
Other expenses, net	26	(29,8)	(5,6)
Management fees		(6,2)	(3,1)
Restructuring and other non-recurring costs	26	(20,8)	(7,6)
Operating (loss)/profit		(41,7)	105,1
Gain arising on step acquisitions	26	—	134,8
Share of profit of associates		—	11,7
Finance income	27	30,5	16,6
Finance costs	27	(204,7)	(111,6)
(Loss)/profit before income tax expenses		(215,8)	156,6
Income tax benefit/(expenses)	22	26	(32,5)
(Loss)/profit for the year		(189,8)	123,9
<i>Attributable to equity holders of the parent</i>		(148,9)	118,4
<i>Attributable to non-controlling interests</i>		(40,9)	5,5

(*) Operating profit before depreciation and amortization is further referred to as “EBITDA” in these consolidated financial statements.

The accompanying notes form an integral part of these consolidated financial statements.

ALTICE VII S.À R.L.
Consolidated statement of other comprehensive income
Year ended December 31, 2012

Notes	Year ended December 31, 2012	Year ended December 31, 2011
	(in millions of euros)	
(Loss)/profit for the year	(189,8)	123,9
Other comprehensive income		
Exchange differences on translating foreign operations	(5,1)	0,4
Net fair value gain on available-for-sale financial assets	—	0,3
Total comprehensive (loss)/income for the year	<u>(194,9)</u>	<u>124,6</u>
<i>Attributable to equity holders of the parent</i>	<i>(152,6)</i>	<i>117,2</i>
<i>Attributable to non-controlling interests</i>	<i>(42,2)</i>	<i>7,4</i>

The accompanying notes form an integral part of these consolidated financial statements.

ALTICE VII S.À R.L.
Consolidated statement of financial position
Year ended December 31, 2012

	Notes	December 31, 2012	December 31, 2011
(in millions of euros)			
ASSETS			
Current assets			
Cash and cash equivalents	11	129,7	19,8
Trade receivables	10	150,8	102,7
Other receivables	10	32,4	17
Inventories	9	6,1	6,1
Current tax assets	10	5,5	5,1
Total Current assets		324,5	150,8
Non-current assets			
Restricted cash	7	9,6	41,4
Deferred tax assets	22	19,3	0,3
Investments in financial assets available for sale	7	6,1	8,5
Long term trade receivables	7	18,7	2,4
Other long-term trade receivables	8	24,6	28,4
Property, Plant & Equipment	6	1 067,8	901,7
Other Intangible assets	5	458,5	458,3
Goodwill	4	790,9	911,9
Total non-current assets		2,395,5	2,352,9
Total assets		2,720,0	2,503,7
EQUITY AND LIABILITIES			
Current liabilities			
Borrowings from banking corporations and debentures	17	113,2	241,8
Trade payables	19	311,3	208,2
Others payables	19	108,1	98,4
Current loans from related parties	17	2,7	2,9
Current tax liabilities		10,7	7,2
Total current liabilities		546	558,5
Non-current liabilities			
Borrowings from banking corporations and debentures	17	1,373,5	835,2
Non-current loans from related parties	17	109,0	127,1
Other financial liabilities	17	173,5	32,1
Provisions	15	25,6	40,5
Other non-current liabilities	20	49,5	46,1
Retirement benefit obligations	15	9,1	6,9
Deferred tax liabilities	22	148,2	123,7
Total non-current liabilities		1,888,3	1,211,6
Equity			
Issued capital	12	7,4	7,4
Other reserves	14	277,5	232,9
Retained earnings		144,5	25,8
Net (loss)/income—attributable to the equity holders		(148,9)	118,4
Equity attributable to equity holders of the parent		280,5	384,5
Non-controlling interests		5,2	349,2
Total equity		285,7	733,6
Total equity and liabilities		2,720,0	2,503,7

The accompanying notes form an integral part of these consolidated financial statements.

ALTICE VII S.À R.L.
Consolidated statement of changes in equity
Year ended December 31, 2012

	Issued capital	Other reserves	Retained earnings	Net income	Total equity attributable to equity holders of the parent	Non- controlling interests	Total equity
(in millions of euros)							
Equity at January 1, 2011	7,8	254,9	(13,7)	40,2	289,2	0,4	123,9
Allocation to retained earnings			40,2	(40,2)			
Profit for the year				118,4	118,4	5,5	123,9
Variation in CPEC		(22,7)			(22,7)		(22,7)
Employee benefits		0,1			0,1	0,3	0,4
Increase in share capital	(0,4)				(0,4)		(0,4)
Variation in Currency Translation Reserve		(1,4)			(1,4)	1,8	0,4
Increase or decrease of ownership interest		4,5			4,5	(2,5)	2
Acquisition of an associates		(3,7)			(3,7)	343,5	339,8
Other variations		1,2	(0,8)		0,4	0,2	(0,7)
Equity at December 31, 2011	7,4	232,9	25,8	118,4	384,5	349,2	733,6
Allocation to retained earnings			118,4	(118,4)			
Loss for the year				(148,9)	(148,9)	(40,9)	(189,8)
Employee benefits		0,1			0,1	0,4	0,4
Variation in Currency Translation Reserve		(3,7)			(3,7)	(1,3)	(5,1)
Increase or decrease of ownership interest		(16,2)			(16,2)	21,6	5,4
Dividends paid						(26,0)	(26,0)
Option warrants		(3,9)			(3,9)		(3,9)
Purchase of minority interest		68,3			68,3	(298,4)	(230,1)
Other variations		—	0,3		0,3	0,8	1,1
Equity at December 31, 2012	7,4	277,5	144,5	(148,9)	280,5	5,2	285,7

The accompanying notes form an integral part of these consolidated financial statements.

ALTICE VII S.À R.L.
Consolidated statement of cash flows
Year ended December 31, 2012

	Notes	December 31, 2012	December 31, 2011
(in millions of euros)			
Net (loss)/income, including non-controlling interests		(189,8)	123,9
Adjustments for:			
Share of profit of associates		—	(11,7)
Depreciation and amortization		388,2	176,4
Gains and losses on disposals		4,8	6,0
Other non-cash operating gains and losses		56,7	(168,5)
Net cash provided by operating activities after changes in working capital, finance costs and income tax		259,9	126,1
Finance costs recognized in profit and loss		174,0	89,3
Income tax (benefit)/expense recognized in profit and loss		(22,8)	32,5
Income tax received/(paid)		1,6	(1,8)
Changes in working capital		51,8	60,2
Net cash provided by operating activities		464,5	306,4
Purchases of tangible and intangible assets		(347,0)	(189,8)
Acquisitions of Financial Assets		(35,8)	—
Proceeds from disposal of tangible, intangible and financial assets		0,1	0,4
(Decrease)/increase in loans and other non-current financial assets		(16,1)	1,2
Use of restricted cash		32,6	(40,8)
Net cash (outflow)/inflow on acquisition of subsidiaries	3.3	(35,1)	(347,3)
Transactions with non-controlling interests	27	(172,9)	—
Net cash provided used by investing activities		(574,2)	(576,3)
Proceeds from issue of equity instruments	12	—	(0,4)
Dividends paid to non-controlling-interests	27	(26,0)	—
Proceeds from issue of debts	17	891,5	823,0
Repayment of debt	17	(528,3)	(481,2)
Interest paid		(117,8)	(69,0)
Net cash provided in financing activities		219,3	272,4
Effects of exchange rate changes on the balance of cash held in foreign currencies		0,2	(0,9)
Net increase in cash and cash equivalents		109,9	1,6
Cash and cash equivalents at beginning of year	11	19,8	18,2
Net increase in cash and cash equivalents		109,9	1,6
Cash and cash equivalents at end of year	11	129,7	19,8

The accompanying notes form an integral part of these consolidated financial statements.

ALTICE VII S.À R.L.
Notes to the consolidated financial statements
December 31, 2012

1—Notes to the consolidated financial statements

1.1 General description of the Group and its activities

Altice VII (the “Company”) is a private limited liability company (*société à responsabilité limitée*) incorporated under the laws of the Grand Duchy of Luxembourg on December 15, 2008, and registered under the number B 143.725 in Luxembourg. The Group refers to the Company and its subsidiaries. The Company was initially established as a public limited company (*société anonyme*) and then converted to a private limited liability company on October 7, 2009.

The registered office of the Company is established at 3, boulevard Royal, L-2449 Luxembourg, and its sole equity holder is NEXT LP. The ultimate controlling party is considered to be Patrick Drahi.

The Group offers a variety of services over its cable and mobile infrastructure, including, but not limited to, pay television, broadband Internet access, fixed-line telephony and mobile telephony to residential customers, and, to a lesser extent, corporate customers, depending on the country. Available cable-based service offerings depend on the bandwidth capacity of its cable networks and whether they have been upgraded for two-way communications. Where possible, the Group intends to deploy the same technologies and equipments across its footprints to deploy economies of scale and common knowledge. In addition, the Group companies aim at sharing skills and best practices across the various operations of the Group.

Television service offerings include basic and premium programming, and, in most markets, incremental product and service offerings such as enhanced pay-per-view programming, including video-on-demand (“VoD”) and near-video-on-demand (“NVOD”), digital video recorders (“DVR”), high definition (“HD”) television services and, in certain areas, exclusive content, purchased or produced. The Group tailors its basic and premium channel line-up to each country of operation according to culture, demographics, programming preferences and local regulation. The Group also offers broadband Internet access services and fixed-line telephony in all of its broadband communications markets. It also owns and operates mobile infrastructures in certain geographies (Israel and the French Overseas Territories), and offers mobile services through an MVNO (Mobile virtual network operator) arrangement in Belgium.

2—Principles governing the preparation of the Consolidated Financial Statement

2.1 Basis of preparation of the consolidated financial statements:

The consolidated financial statements have been prepared on the historical cost basis, except for the liability in respect of share based payment transaction, derivatives and financial instruments at fair value through profit and loss, available for sale financial assets. The principal accounting policies are set out below.

2.1.1 Compliance with accounting standards

The 2012 consolidated financial statements of Altice VII Group, therein “the Group”, have been prepared in accordance with International Financial Reporting Standards as adopted in the European Union (IFRS).

2.1.2 Standards issued but not yet effective

In its financial statements, the Group has not anticipated the following standards and interpretations, for which application is not mandatory for periods opened from January 1, 2012. Their impact on the Group’s financial statements is estimated not to be significant and/or not applicable. This essentially relates to:

IFRIC 20 “Overdraft expenses”.

IFRS 1 amended “First application of IFRS” concerning serious hyperinflation and the abolition of dates set for the first adopters, published by the IASB on December 20, 2010 and adopted by the

ALTICE VII S.À R.L.
Notes to the consolidated financial statements (Continued)
December 31, 2012

2—Principles governing the preparation of the Consolidated Financial Statement (Continued)

European Union on December 29, 2012. Application of this standard is mandatory from January 1, 2013.

2.2 Significant accounting judgments and estimates used in the preparation of the financial statements

2.2.1 Judgments

In the process of applying the significant accounting policies, the Group has exercised its judgment and has taken into account matters which have the most significant impact on the amounts that have been recognized in the consolidated financial statements.

2.2.2 Estimates and assumptions

The preparation of the financial statements requires the Group to make estimates and assumptions that have an effect on the application of the accounting policies and on the reported amounts of assets, liabilities, revenues and expenses. These estimates and underlying assumptions are reviewed regularly. Changes in accounting estimates are reported in the period in which the estimate changes.

2.2.3 Impairment of goodwill

Determining whether goodwill is impaired requires an estimation of the value in use of the cash-generating units to which goodwill has been allocated. The value in use calculation requires the managers to estimate the future cash flows expected to arise from the cash-generating unit and a suitable discount rate in order to calculate present value. Where the actual future cash flows are less than expected, a material impairment loss may arise.

The carrying amount of goodwill as at December 31, 2012 was EUR 790,9 million (December 31, 2011: EUR 911,9 million). Details of the impairments are set out in Note 2.8.

2.2.4 Legal claims

In estimating the likelihood of outcome of legal claims filed against the Group and its investees, the Group companies rely on the opinion of their legal counsel. These estimates are based on the legal counsel's best professional judgment, taking into account the stage of proceedings and historical legal precedents in respect of the different issues. Since the outcome of the claims will be determined in courts, the results could differ from these estimates.

2.2.5 Post-employment benefits

The liability in respect of post-employment defined benefit plans is determined using actuarial valuations. The actuarial valuation involves making assumptions about, among others, discount rates, expected rates of return on assets, future salary increases and mortality rates. Due to the long-term nature of these plans, such estimates are subject to uncertainty.

2.2.6 Deferred tax asset

Deferred tax assets are recognized for deductible temporary differences and carried forward tax losses as and when management estimates that it is probable that future taxable profits will be available to utilize those temporary differences and tax losses.

2.2.7 Discounting of YFPEC

The Group has loans with its equity holder which are currently non-interest bearing and therefore considered as not being at arm's length. In determining the present value, a discount rate of 4,76% has been used.

ALTICE VII S.À R.L.
Notes to the consolidated financial statements (Continued)
December 31, 2012

2—Principles governing the preparation of the Consolidated Financial Statement (Continued)

2.3 Basis of consolidation

2.3.1 Subsidiaries

All companies in which the Group has a controlling interest are fully consolidated. Control exists when the Group has the power, directly or indirectly, to govern the financial and operating policies of an enterprise so as to obtain benefits from its activities. The financial statements of subsidiaries are included in the consolidated financial statements from the date that control commences until the date that control ceases.

All intra-group transactions, balances, income and expenses are eliminated in full on consolidation. Non-controlling interests in subsidiaries are identified separately from the Group's equity therein.

2.3.2 Associates

Investments, over which the Group exercises significant influence, but not control, are accounted for under the equity method. Such investees are referred to as "associates" throughout these consolidated financial statements.

Significant influence is presumed to exist when the Group holds at least 20% of the voting power in the associates. Associates are initially recognized at cost at acquisition date. The consolidated financial statements include the Group's share of income and expenses, from the date significant influence commences until the date that significant influence ceases.

2.3.3 Dates

The consolidated financial statements of the Group have been prepared as of the same date and for identical periods on an going concern basis. The accounting policies in the financial statements of the subsidiaries have been implemented in a uniform manner throughout the Group.

2.4 Functional currency

The Consolidated Financial Statements are presented in millions of euros. Euro is the functional currency of Altice VII, the parent company, and the presentation currency of the Group as well.

The functional currency, which is the currency that best reflects the economic environment in which the Group operates and conducts its transactions, is separately determined for each Group entity, including an associate accounted for using the equity method, and is used to measure its financial position and operating results.

2.5 Foreign currency translation

The functional currency of the Group is euro. In individual companies, transactions in foreign currencies are recorded at the exchange rate at the date of the transaction. Monetary assets and liabilities in foreign currencies are translated at year-end rates. Any resulting exchange differences are accounted for in the income statement. On consolidation, assets and liabilities of Group entities reported in their functional currencies are translated into euro, the Group's presentation currency, using the year-end exchange rates. Income and expense items are translated into euro at the annual weighted average exchange rate or at the rate of the date the transaction occurred for significant items.

Differences arising from the retranslation of opening net assets of Group entities, together with differences arising from the restatement of the net results for the year of Group entities, are recognized in other comprehensive income.

ALTICE VII S.À R.L.
Notes to the consolidated financial statements (Continued)
December 31, 2012

2—Principles governing the preparation of the Consolidated Financial Statement (Continued)

2.6 Goodwill and business combinations

Business combinations are accounted for in accordance with the purchase method. The acquiree's identifiable assets, liabilities and contingent liabilities that meet the conditions for recognition under IFRS 3 "Business Combinations" are recognized at their fair value at acquisition date.

The Group recognizes goodwill as of the acquisition date and is measured as the excess of (a) over (b) as follows :

(a) *The aggregate of:*

The consideration transferred, which generally requires acquisition-date fair value;

The amount of any non-controlling interests in the acquiree;

In a business combination achieved in stages, the acquisition-date fair value of the acquirer's previously held equity interest in the acquiree;

(b) *The net of the acquisition-date balances of the identifiable assets acquired and the liabilities measured in accordance with IFRS 3.*

Any excess of the cost of acquisition over the Group's share in the fair value of all identified assets and liabilities is recognized as goodwill.

The goodwill is determined provisionally by the end of the period. The Group recognizes any adjustments to those provisional values within twelve months after the acquisition date.

During the measurement period, the acquirer shall recognize adjustments to the provisional amounts as if the accounting for the business combination had been completed at the acquisition date. Thus, the acquirer shall revise comparative information for prior periods presented in financial statements as needed, including making any change in depreciation, amortization or other income effects recognized in completing the initial accounting.

If the net of the acquisition-date amounts of the identifiable assets acquired and the liabilities assumed exceeds the purchase price, a gain is recognized immediately.

Subsequently, goodwill is measured at its initial amount less recorded accumulated impairment losses. Impairment loss for goodwill is recorded in the income statement as a deduction from operating profit (account "Depreciation and amortization") and shall not be reversed subsequently.

Changes in the Group's ownership interests in subsidiaries that do not result in the Group losing control over the subsidiaries are accounted for as equity transactions. The carrying amounts of the Group's interests and the non-controlling interests are adjusted to reflect the changes in their relative interests in the subsidiaries. Any difference between the amount by which the non-controlling interests are adjusted and the fair value of the consideration paid or received is recognized directly in equity and attributed to owners of the Group.

2.7 Other intangible assets

Intangible assets acquired separately are recorded at cost on initial recognition, with the addition of direct acquisition costs. Intangible assets acquired in a business combination are measured at fair value as of the date of acquisition. Following initial recognition, intangible assets are carried at cost less any accumulated amortization and less any accumulated impairment losses. In our Israeli entity, the costs of producing in-house content is also considered to be an intangible assets and recognized at the cost of production of the shows. . Following initial recognition, these intangible assets are carried at cost less any accumulated amortization and less any accumulated impairment losses.

According to management, intangible assets have either definite or indefinite useful lives.

ALTICE VII S.À R.L.
Notes to the consolidated financial statements (Continued)
December 31, 2012

2—Principles governing the preparation of the Consolidated Financial Statement (Continued)

Assets with definite useful lives are amortized over their useful lives and assessed for impairment signs which would indicate impairment in value. The amortization period and the amortization method for an intangible asset with a finite useful life are reviewed at least once a year. Changes in the expected useful life or the expected pattern of consumption of future economic benefits that are expected to derive from the asset are treated as a change in an accounting estimate which is treated prospectively. The amortization expenses regarding intangible assets with finite useful lives are recognized in the income statement.

The useful lives of the intangible assets are as follows:

	Duration
Software	3 years
Customer relations	7 to 37 years
Licences	5 years
Customer relations with a defined contractual term	3 years
Content costs	3 years
Subscriber purchase costs	based on average duration of subscriptions

Assets with indefinite useful lives are tested for impairment annually as well as there is an indication that it may be impaired by comparing their carrying amount with their recoverable amount.

2.8 Impairment of tangible and intangible assets

Each time events or changes in the economic environment indicate a current risk of impairment of goodwill, other intangible assets, property, plant and equipment and assets in progress, the Group re-examines the value of these assets. In addition, goodwill, other intangible assets with an indefinite useful life, and intangible assets in progress are all subject to an impairment test performed each fiscal year.

This test is performed in order to compare the recoverable amount of an asset to its carrying amount.

An asset's recoverable amount is the higher of an asset's fair value less costs to sell and its value in use. Recoverable amount is determined for an individual asset, unless the asset does not generate cash inflows that are largely independent of those from other assets or groups of assets. In that case, recoverable amount is determined for the cash-generating unit to which the asset belongs. A Cash Generating Unit ("CGU") is the smallest identifiable group of assets that generates cash inflows that are largely independent of the cash inflows from other assets or groups of assets.

The value in use of each asset or group of assets is determined as the discounted value of future cash flows (discounted cash flow method or "DCF") by using a discount rate after tax specific to each asset or group of assets concerned.

The fair value less costs to sell is the amount obtained from the sale of the asset or group of assets in an arm's length transaction between knowledgeable and willing parties, less costs to sell.

When the carrying amount of an asset exceeds its recoverable amount, an impairment loss is recognized in the caption "Depreciation and amortization" in the income statement. Only impairment loss recognized on assets other than goodwill such as depreciable intangible assets, intangible assets with indefinite useful life and property, plant and equipment, may be reversed.

2.9 Property, plant and equipment

Property, plant and equipment are presented at cost with the addition of direct purchase costs and less accumulated depreciation and accumulated losses on impairment and they do not include routine maintenance expenses. The cost includes spare parts and ancillary equipment that can only be used in connection with the plant and machinery.

ALTICE VII S.À R.L.
Notes to the consolidated financial statements (Continued)
December 31, 2012

2—Principles governing the preparation of the Consolidated Financial Statement (Continued)

Depreciation is calculated using the straight line method over the estimated useful lives of the assets, as follows:

	Duration
Buildings	25 to 50 years
Cables Network	4 to 20 years
Call center (primarily electronic equipment)	5 to 9 years
Converters and modems	7 years
Computers and ancillary equipment	3 to 6 years
Office furniture and equipment	6 to 16 years
Communication network infrastructure	6 to 16 years
Leasehold contracts	see below

Leasehold contracts are depreciated according to the straight line method during the rental period (including the option period for an extension by the Group, which it intends to exercise) or the estimated useful lifetime of the improvement.

Elements of a fixed asset item, having a cost that is significant in comparison to the overall cost of the item, are depreciated separately, using the components method. The depreciation is calculated in accordance with the straight line method at annual rates that are considered to be sufficient in order to depreciate the assets over the length of their estimated useful lives.

The useful life, depreciation method and residual value of an asset are reviewed at least each annually and any changes are accounted for prospectively as a change in accounting estimate.

2.10 Leasing

Leases are classified as finance leases whenever the terms of the lease transfer substantially all the risks and rewards of ownership to the lessee. All other leases are classified as operating leases.

2.10.1 The Group as lessor

Amounts due from lessees under finance leases are recognized as receivables at the amount of the Group's net investment in the leases. Finance lease income is allocated in an accounting periods so as to reflect a constant periodic rate of return on the Group's net investment outstanding in respect of the leases.

Rental income from operating leases is recognized on a straight-line basis over the term of the relevant lease. Initial direct costs incurred in negotiating and arranging an operating lease are added to the carrying amount of the leased asset and recognized on a straight-line basis over the lease term.

Rental income from the leasing of customer premises equipment (set up boxes, modems and decoders) is recognized on a straight-line basis over the term of the subscription held by the client. At the end of the contract or in case of voluntary contract termination by the client, this equipment is repossessed and thus remains in the inventory of the Group.

2.10.2 The Group as lessee

Assets held under finance leases are initially recognized as assets of the Group at their fair value at the inception of the lease or, if lower, at the present value of the minimum lease payments. The corresponding liability to the lessor is included in the consolidated statement of financial position as a finance lease obligation.

Lease payments are apportioned between finance expenses and reduction of the lease obligation so as to achieve a constant rate of interest on the remaining balance of the liability. Finance expenses are recognized immediately in profit or loss, unless they are directly attributable to qualifying assets, in

ALTICE VII S.À R.L.
Notes to the consolidated financial statements (Continued)
December 31, 2012

2—Principles governing the preparation of the Consolidated Financial Statement (Continued)

which case they are capitalized in accordance with the Group's general policy on borrowing costs (see note 2.12 below). Contingent rentals are recognized as expenses in the periods in which they are incurred.

Operating lease payments are recognized as an expense on a straight-line basis over the lease term, except where another systematic basis is more representative of the time pattern in which economic benefits from the leased asset are consumed. Contingent rentals arising under operating leases are recognized as an expense in the period in which they are incurred.

In the event that lease incentives are received to enter into operating leases, such incentives are recognized as a liability. The aggregate benefit of incentives is recognized as a reduction of rental expense on a straight-line basis, except where another systematic basis is more representative of the time pattern in which economic benefits from the leased asset are consumed.

2.11 Borrowing costs

Borrowing costs that are directly attributable to the acquisition, construction or production of a qualifying asset are capitalized as part of the cost of that asset. According to management, it does not take a substantial period of time to get ready for the intended use because of the incremental deployment of the network. This standard has consequently no impact on the consolidated financial statements.

2.12 Government grants

Government grants are not recognized until there is reasonable assurance that the Group will comply with the conditions attaching to them and that the grants will be received.

Government grants are recognized in profit or loss on a systematic basis over the periods in which the Group recognizes as expenses the related costs for which the grants are intended to compensate. Specifically, government grants whose primary condition is that the Group should purchase, construct or otherwise acquire non-current assets are recognized as deferred revenue in the consolidated statement of financial position and transferred to income statement on a systematic and rational basis over the useful lives of the related assets.

Government grants that are receivable as compensation for expenses or losses already incurred or for the purpose of giving immediate financial support to the Group with no future related costs are recognized in profit or loss in the period in which they become receivable.

The benefit of a government loan at a below-market rate of interest is treated as a government grant, measured as the difference between proceeds received and the fair value of the loan based on prevailing market interest rates.

2.13 Financial assets

The Group classifies financial assets in four categories: available-for-sale, loans and receivables, held-to-maturity and financial assets at fair value through profit and loss. They are classified as current assets and non-current assets according to IAS 1 ("*Presentation of Financial Statements*").

Purchases and sales of all financial assets are recognized on a trade date basis.

2.13.1 Available-for-sale financial assets

Available-for-sale financial assets are recognized initially at fair value plus transaction costs that are directly attributable to the acquisition or issue of the financial asset. After initial recognition, they are reported at their fair value. Gains and losses arising from changes in their fair value are recognized directly in equity, until the security is disposed of or is determined to be impaired, at which time the cumulative gain or loss previously recognized in equity is included in the profit or loss for the period.

ALTICE VII S.À R.L.
Notes to the consolidated financial statements (Continued)
December 31, 2012

2—Principles governing the preparation of the Consolidated Financial Statement (Continued)

Available-for-sale financial assets consist mainly of shares in non-consolidated companies. Fair value corresponds to quote price for listed securities. For non-listed securities, and when a reliable estimate of fair value cannot be made using valuation techniques, the Group values financial assets at historical cost, less any impairment losses.

When there is objective evidence that available-for-sale assets are impaired, the cumulative impairment loss included in equity is reclassified from other comprehensive income to income. Objective evidence that an available-for-sale financial asset is impaired includes, among other things, a decrease in the estimated future cash flows arising from these assets, as a result of significant financial difficulty of the issuer, a material decrease in expected future profitability or a prolonged decrease in the fair value of the security. Impairment losses recognized in profit or loss for equity instruments classified as available-for-sale are never reversed through profit or loss.

2.13.2 Loans and receivables

Loans and receivables are recognized initially at fair value plus transaction costs that are directly attributable to the acquisition. After initial recognition, they are measured at amortized cost using the effective interest rate method.

This category mainly includes trade receivables.

If there is objective evidence that an impairment loss has occurred, the amount of this loss, measured as the difference between the financial assets' carrying value and its recoverable amount is recognized in the income statement. Impairment losses may be reversed if the recoverable amount of the asset subsequently increases in the future.

2.13.3 Held-to-maturity financial assets

Held-to-maturity financial assets are financial assets with fixed or determinable payments and fixed maturity that the Group has both the intention and ability to hold to maturity. Financial assets that are designated as held-to-maturity are measured at amortized cost, in accordance with the effective interest rate method.

They are reviewed for impairment on an individual basis if there is any indication that they may be impaired.

The Group currently does not hold any held to maturity financial assets.

2.13.4 Financial assets measured at fair value through profit or loss

These financial assets are measured at fair value with gains and losses recorded as finance income and costs.

This category mainly includes:

Assets held for trading which the Group intends to sell in the near future (primarily marketable securities);

Assets voluntarily classified at inception in this category;

Derivatives financial assets.

2.14 Inventories

Inventories are measured at the lower of cost and net realizable value. The cost of inventories comprises costs of purchase and costs incurred in bringing the inventories to their present location and condition. Net realizable value is the estimated selling price in the ordinary course of business less the estimated costs of completion and the estimated selling costs.

ALTICE VII S.À R.L.
Notes to the consolidated financial statements (Continued)
December 31, 2012

2—Principles governing the preparation of the Consolidated Financial Statement (Continued)

Cost of inventories is determined using the weighted average cost method.

The Group periodically evaluates the condition and age of inventories and makes provisions for slow moving inventories accordingly.

2.15 Cash and cash equivalents

Cash consists of cash in banks and deposits.

Cash equivalents are considered as highly liquid investments, including unrestricted short-term bank deposits with an original maturity of three months or less from the date of acquisition or with a maturity of more than three months, but which are redeemable on demand without penalty and which form part of the Group's cash management.

2.16 Restricted cash

Restricted cash is considered to be cash that is dedicated to the repayment of the Group's liabilities to banking entities in accordance with the Group's credit agreement.

2.17 Derivatives

Derivatives are initially recognized at fair value on the date a derivative contract is entered into and are subsequently reassessed at their fair value.

The Group enters into interest rate swaps and caps to manage its interest or foreign currency exchange rate exposure. These contracts do not qualify as hedges for accounting purposes according to IAS 39, as there was no formal designation and documentation of the hedging relationship at inception. Changes in the fair value of any of these derivative instruments are recognized immediately in the income statement within financial income and expenses.

2.18 Share based payment arrangements

The Group's employees are entitled to remuneration in the form of equity-settled share-based payment transactions and certain employees are entitled to remuneration in the form of cash-settled share-based payment transactions that are measured based on the increase in the Group's share price. These stock options based remunerations mainly concerned the Israeli entity, HOT Telecom and these plans were terminated post the take private of the company in December 2012 and the delisting of all active shares of HOT Telecom in the Tel Aviv stock exchange.

2.19 Financial liabilities

Financial liabilities other than derivative instruments include:

2.19.1 Financial liabilities at amortized cost

These financial liabilities are measured at amortized cost calculated based on the effective interest rate method according to IAS 39. The effective interest rate is the internal yield rate that exactly discounts future cash flows through the term of the financial liability. Fees, debt issuance and transaction costs are included in the calculation of the effective interest rate over the expected life of the instrument. The accrued interests are included in "Current portion of financial liabilities" in the statement of financial position.

2.19.2 Financial liabilities that are measured at fair value through profit or loss

Financial liabilities at fair value through profit or loss include financial liabilities classified as held for trading and financial liabilities designated upon initial recognition as at fair value through profit or loss.

ALTICE VII S.À R.L.
Notes to the consolidated financial statements (Continued)
December 31, 2012

2—Principles governing the preparation of the Consolidated Financial Statement (Continued)

Financial liabilities are classified as held for trading if they are acquired for the purpose of sale in the near term. Gains or losses on liabilities held for trading are recognized in profit or loss.

Derivatives, including bifurcated embedded derivatives, are classified as held for trading unless they are designated as effective hedging instruments. In the event of a financial instrument that contains one or more embedded derivatives, the entire combined instrument may be designated as a financial liability at fair value through profit or loss only upon initial recognition.

The Group assesses whether embedded derivatives are required to be bifurcated from host contracts when the Group first becomes party to the contract. Reassessment only occurs if there is a change in the terms of the contract that significantly modifies the cash flows that would otherwise be required.

The fair value of financial instruments that are traded in an active market is determined by reference to quoted market prices at the close of business on the balance sheet date. For financial instruments for which there is no active market, fair value is determined by the use of valuation techniques. Such techniques include evaluation based on transactions that have been executed recently under market terms, reference to the current market value of another instrument, which is substantially the same, discounted cash flow analysis or other valuation models.

2.19.3 Classification as debt or equity

Debt and equity instruments issued by a Group entity are classified as either financial liabilities or as equity in accordance with the substance of the contractual arrangements and the definitions of a financial liability and an equity instrument.

2.19.4 Equity instruments

An equity instrument is any contract that evidences a residual interest in the assets of an entity after deducting all of its liabilities. Equity instruments issued by a group entity are recognized at the proceeds received, net of direct issue costs.

Repurchase of the Company's own equity instruments is recognized and deducted directly in equity. No gain or loss is recognized in profit or loss on the purchase, sale, issue or cancellation of the Company's own equity instruments.

The Company also issued some CPECs (Convertible Preferred Equity Certificates).

2.20 Other liabilities

2.20.1 Provisions

A provision in accordance with IAS 37 is recognized in the statement of financial position when the Group has a present obligation (legal or implicit) as the result of a past event and it is expected that the use of economic resources will be required in order to settle the obligation and it is possible to reliably estimate it. Where the impact is significant, the provision is measured by discounting the forecasted future cash flows, using a pre-tax interest rate that reflects the expectations of the market in respect of the time frame of the money and in certain cases, the risks that are specific to the liability.

The following types of provisions are recorded in the consolidated financial statements:

2.20.1.1 Legal claims

A provision regarding legal claims is recognized when the Group has a present legal commitment or an implicit commitment resulting from a past event; when it is more likely than not that the Group will be required to expend economic resources to clear the commitment, when it is possible to estimate it reliably and when the effect of time is significant, the provision is measured according to the present value.

ALTICE VII S.À R.L.
Notes to the consolidated financial statements (Continued)
December 31, 2012

2—Principles governing the preparation of the Consolidated Financial Statement (Continued)

2.20.1.2 Warranty

The Group recognizes a provision for warranty for the sale of its products. The warranty is limited to malfunctions as defined by the Group and does not include warranty for damages incurred by the customer.

2.20.1.3 Onerous contracts

Present obligations arising under onerous contracts are recognized and measured as provisions. An onerous contract is considered to exist where the Group has a contract under which the unavoidable costs of meeting the obligations under the contract exceed the economic benefits expected to be received from the contract.

2.20.1.4 Restructuring

A restructuring provision is recognized when the Group has developed a detailed formal plan for the restructuring and has raised a valid expectation in those affected that it will carry out the restructuring by starting to implement the plan or announcing its main features to those affected by it. The measurement of a restructuring provision includes only the direct expenditures arising from the restructuring, which are those amounts that are both necessarily entailed by the restructuring and not associated with the ongoing activities of the entity.

2.20.2 Liabilities for employment benefits

In accordance with the laws and practices of each country in which it operates, the Group participates in, or maintains, several employee benefits. These are as follows:

2.20.2.1 Short-term benefits for employees

Short-term benefits for employees include salaries, vacation pay, sick leave, recuperation pay and employers' deposits for national insurance and are recognized as an expense when the services are provided. A liability in respect of a cash bonus or a profits participation scheme is recognized where the Group has a legal or an implicit commitment to pay the said amount in respect of service that has been provided by the employee in the past and where the amount can be reliably estimated.

2.20.2.2 Post-retirement benefits

In Israel, the Group operates a defined benefits plan in respect of the payment of severance pay in accordance with the Israeli Severance Pay Law. According to this Law, employees are entitled to receive severance pay if they are dismissed or on their retirement. The liability in respect of the termination of employee-employer relations is measured in accordance with the actuarial value of a forecast unit of entitlement method. The actuarial calculation takes into account increases in salaries in the future and the rate at which employees leave the Group and this on the basis of an estimate of the timing of the payment. The amounts are presented on the basis of the discounting of the forecast future cash flows, in accordance with government bonds' interest rates, whose repayment dates are close to the period relating to the liability in respect of severance pay.

The Group deposits funds in respect of its severance pay liability, in a routine manner, in pension funds and insurance companies (hereafter—the plan assets). The plan assets are assets that are held by the employee benefits plan for the long-term or in qualifying insurance policies. The plan assets are not available for use by the Group's creditors, and cannot be paid directly to the Group.

The liability regarding employee benefits presented in the statement of financial position represents the present value of the defined benefits obligation less the fair value of the plan assets, and the past service costs. Actuarial gains and losses are reflected in the income statement in the period in which they arise, as part of the salary costs.

ALTICE VII S.À R.L.
Notes to the consolidated financial statements (Continued)
December 31, 2012

2—Principles governing the preparation of the Consolidated Financial Statement (Continued)

The Group has defined contribution plans pursuant to the Severance Pay Law under which the Group pays fixed contributions and will have no legal or constructive obligation to pay further contributions if the fund does not hold sufficient amounts to pay all employee benefits relating to employee service in the current and prior periods. Contributions to the defined contribution plan in respect of severance or retirement pay are recognized as an expense when contributed simultaneously with receiving the employee's services and no additional provision is required in the financial statements.

2.20.2.3 Other long-term employee benefits

The Group's employees are entitled to benefits and other long-service grants. These benefits are accounted for as other long-term benefits since the Group estimates that these benefits will be used and the respective Group's obligation will be settled during the employment period and after one year from the end of the reporting period.

The Group's net obligation regarding other long-term employee benefits is in respect of the future benefit amount due to employees for services rendered in current and prior periods. This amount of benefits is discounted to its present value and the fair value of the assets relating to this obligation is deducted from said amount. The discount rate is determined by reference to the yields on Government bonds whose currency and term are consistent with the currency and term of the Group's obligation. The obligation is calculated using the projected unit credit method. The projected unit credit method sees each period of service as giving rise to an additional unit of benefits and entitlements and measures each unit separately to build up the final obligation. Actuarial gains and losses are recognized in profit or loss in the period in which they occur.

2.20.2.4 Benefits in respect of the termination of employment

Severance pay for employees is reflected as an expense when the Group has made an undertaking, with no real possibility of cancellation, for the dismissal of employees before they reach the customary retirement age in accordance with a detailed formal plan. The benefits that are given to the employees who take voluntary retirement when the Group has offered the employees a plan that encourages voluntary retirement, it is expected that the offer will be accepted and the number of persons accepting the offer can be reliably estimated.

2.21 Income taxes

Taxes on income in the income statement include current taxes and deferred taxes. The tax expenses or income in respect of current taxes or deferred taxes are recognized in profit or loss unless they relate to items that are recorded directly in equity, in these cases the tax effect is reflected under the other comprehensive income items.

2.21.1 Current taxes

The current tax liability is measured using the tax rates and tax laws that have been enacted or substantively enacted by the end of reporting period as well as adjustments required in connection with the tax liability in respect of previous years.

2.21.2 Deferred taxes

Differences existing at closing between the tax base value of assets and liabilities and their carrying value in the Consolidated Statement of Financial Position give rise to temporary differences. Pursuant to the liability method, these temporary differences result in the accounting of:

Deferred tax assets, when the tax base value is greater than the carrying value (expected future tax saving),

ALTICE VII S.À R.L.
Notes to the consolidated financial statements (Continued)
December 31, 2012

2—Principles governing the preparation of the Consolidated Financial Statement (Continued)

Deferred tax liabilities, when the tax base value is lower than the carrying value (expected future tax expense).

Deferred tax assets and liabilities are measured at the expected tax rates for the year during which the asset will be realized or the liability settled, based on tax rates (and tax regulations) enacted or substantially enacted by the closing date. They are reviewed at the end of each year, in line with any changes in applicable tax rates.

Deferred tax assets are recognized for all deductible temporary differences, tax loss carry-forwards and unused tax credits, insofar as it is probable that a taxable profit will be available, or when a current tax liability exists to make use of those deductible temporary differences, tax loss carry-forwards and unused tax credits, except where the deferred tax asset associated with the deductible temporary difference is generated by initial recognition of an asset or liability in a transaction which is not a business combination, and that, at the transaction date, does not impact earnings, nor income tax loss or profit.

For deductible temporary differences arising from investments in subsidiaries, joint ventures and other associated entities, deferred tax assets are recorded to the extent that it is probable that the temporary difference will reverse in the foreseeable future and that a taxable profit will be available against which the temporary difference can be utilized.

The carrying value of deferred tax assets is reviewed at each closing date, and revalued or reduced to the extent that it is more or less probable that a taxable profit will be available to allow the deferred tax asset to be utilized. When assessing the probability of a taxable profit being available, account is taken, primarily, of prior years' results, forecasted future results, non-recurring items unlikely to occur in the future and the tax strategy. As such, the assessment of the Group's ability to utilize tax losses carried forward is to a large extent judgment-based. If the future taxable results of the Group proved to differ significantly from those expected, the Group would be required to increase or decrease the carrying value of deferred tax assets with a potentially material impact on the Statement of Financial Position and Income Statement of the Group.

Deferred tax liabilities are recognized for all taxable temporary differences, except where the deferred tax liability results from goodwill or initial recognition of an asset or liability in a transaction which is not a business combination, and that, at the transaction date, does not impact earnings, nor income tax loss or profit.

For taxable temporary differences arising from investments in subsidiaries, joint ventures and other associated entities, deferred tax liabilities are recorded except to the extent that both of the following conditions are satisfied: the parent, investor or venturer is able to control the timing of the reversal of the temporary difference and it is probable that the temporary difference will not be reversed in the foreseeable future.

Current tax and deferred tax shall be charged or credited directly to other comprehensive income, and not earnings, if the tax relates to items that are credited or charged directly to other comprehensive income.

2.22 Revenue recognition

Revenue from the Group's activities is mainly composed of television, broadband Internet, fixed and mobile telephony subscription and installations fees invoiced to residential and business clients.

Revenue comprises the fair value of the consideration received or receivable for the sale of goods and services in the ordinary course of the Group's activities. Revenue is shown net of value-added tax, returns, rebates and discounts and after eliminating intercompany sales within the Group.

Revenues on bundle packages sold by the Group are split into and recognized under each individual service sold in the bundle. For example, tripe play package revenues are booked under 'triple play

ALTICE VII S.À R.L.
Notes to the consolidated financial statements (Continued)
December 31, 2012

2—Principles governing the preparation of the Consolidated Financial Statement (Continued)

television', 'triple play data' and 'triple play telephony' on a straight-line basis over their subscription period and revenues from telephone calls are recognized in revenue when the service is rendered.

Revenue is recognized as follows, in accordance with IAS 18 *Revenue*:

Revenues from subscriptions for basic cable services, digital television pay, Internet and telephony are recognized in revenue on a straight-line basis over the subscription period; revenues from telephone calls are recognized in revenue when the service is rendered.

When a promotion not related to a customer's past consumption and purchases (such as subscription's rate discount, service free period) is offered to customer in relation to a subscription, the Group recognizes the total amount of billable revenue on a straight-line basis over the term of the contract.

Installation and set-up fees (including connection) for residential customers are accounted for as revenues when the service is rendered, if consideration received is lower than the sales direct costs to acquire the contractual relationship. Service access fees for business clients, when they are only allowed access to the services that are sold associated to an equipment or a service, are deferred and the corresponding revenue is recognized along the statistical client lifetime duration and generally spread over the contractual engagement period.

The revenue related to transmission capacity on terrestrial cables under infeasible rights of use: Infeasible Rights of Use ("IRU") arrangements are recognized on a straight-line basis over the life of the contract.

2.23 Operating profit before depreciation and amortization

The Group has included the subtotal "Operating profit before depreciation and amortization" on the face of the consolidated statement of income (please refer to the Consolidated Statement of Income). The Group believes that this subtotal is useful to users of the Group's financial statements as it provides them with a measure of the operating results which excludes non-cash elements such as depreciation and amortization as well as non-recurring transactions and management fees, enhancing the predictive value of the Group's financial statements and providing information regarding the results of the Group's ongoing trading activities and cash-flow generation that allows investors to better identify trends in the Group's financial performance.

This non-IFRS measure is used by the Group internally to manage and assess the results of its operations, make decisions with respect to investments and allocation of resources, and assess the performance of management personnel.

The Group's subtotal within operating income may not be comparable to similarly titled measures used by other entities. Further, this measure should not be considered as an alternative for operating income as the effects of depreciation, amortization and impairment, excluded from this measure do ultimately affect the operating results. Similarly, the Group's subtotal do not take into account impact of management fees paid to related parties, in order to better reflect economic underlying of the business operated.

2.24 Finance costs

Finance costs primarily comprise:

interest charges and other expenses paid for financing operations recognized at amortized costs,

changes in the fair value of interest rate derivative instruments that do not qualify as hedges for accounting purposes according to "IAS 39",

interest income relating to cash and cash equivalents,

gains on extinguishment of debt.

ALTICE VII S.À R.L.
Notes to the consolidated financial statements (Continued)
December 31, 2012

3—Scope of consolidation

3.1 The entities included in the scope of consolidation

Name of subsidiary	Country	Method of consolidation		Proportion of ownership interest and voting power held by the group	
		December 31, 2012	December 31, 2011	December 31, 2012	December 31, 2011
Altice VII S.à r.l.	Luxembourg	Parent company	Parent company	—	—
Cool Holding LTD	Israel	FC(*)	FC(*)	100%	100%
Hot Telecom Limited Partnership	Israel	FC(*)	FC(*)	100%	64,70%
Hot Mobile LTD	Israel	FC(*)	FC(*)	100%	64,70%
Hot Cable Telecommunications Systems LTD	Israel	FC(*)	FC(*)	100%	64,70%
Hot Net Internet Services LTD (Formerly Hot Investments and Finance LTD)	Israel	FC(*)	FC(*)	100%	64,70%
Hot Properties LTD ⁽¹⁾	Israel	—	FC(*)	—	64,70%
Hot Vision LTD	Israel	FC(*)	FC(*)	100%	64,70%
Nonstop Ventures LTD	Israel	Equity method	Equity method	50%	32,35%
South Saron Communications LTD	Israel	FC(*)	FC(*)	100%	64,70%
Iscarable LTD	Israel	FC(*)	FC(*)	100%	64,70%
Hot TLM Subscription Television LTD	Israel	FC(*)	FC(*)	100%	64,70%
Hot Red LTD ⁽¹⁾	Israel	—	FC(*)	—	64,70%
Hot Eden Cables Systems LTD .	Israel	FC(*)	FC(*)	100%	64,70%
Hot Israel Cables Systems LTD .	Israel	FC(*)	FC(*)	100%	64,70%
Hot Gold LTD ⁽¹⁾	Israel	—	FC(*)	—	64,70%
Hot Net Limited Partnership . . .	Israel	FC(*)	FC(*)	100%	64,70%
Hot EDOM LTD	Israel	FC(*)	—	100%	—
Zira (Copyrights on the Internet) LTD	Israel	Equity method	—	25%	—
Altice Securities S.à r.l.	Luxembourg	FC(*)	FC(*)	100%	100%
Altice Africa S.à r.l.	Luxembourg	FC(*)	FC(*)	100%	100%
Altice Blue One S.A.S.	France	FC(*)	FC(*)	100%	100%
MTVC S.A.	France	FC(*)	FC(*)	100%	100%
WSG S.A.	France	FC(*)	FC(*)	99,95%	99,95%
Green ch.	Switzerland	FC(*)	FC(*)	99,12%	99,12%
Valvision S.A.S.	France	FC(*)	FC(*)	100%	100%
Auberimmo S.A.S.	France	FC(*)	FC(*)	100%	100%
Green Datacenter AG	Switzerland	FC(*)	FC(*)	97%	97%
Deficom Telecom S.à r.l.	Luxembourg	FC(*)	FC(*)	74%	74%
Coditel Holding Lux II S.à r.l. . .	Luxembourg	FC(*)	FC(*)	44,39%	44,39%
Coditel Holding Lux S.à r.l. . . .	Luxembourg	FC(*)	FC(*)	44,39%	44,39%
Coditel Holding S.A.	Luxembourg	FC(*)	FC(*)	44,39%	44,39%
Coditel Brabant S.p.r.l.	Belgium	FC(*)	FC(*)	44,39%	44,39%
Coditel S.à r.l.	Luxembourg	FC(*)	FC(*)	44,39%	44,39%
Coditel Management S.à r.l. . . .	Luxembourg	FC(*)	FC(*)	44,39%	44,39%
Altice Caribbean S.à r.l.	Luxembourg	FC(*)	—	100%	—
Altice Portugal S.A.	Portugal	FC(*)	—	60%	—
Cabovisao S.A.	Portugal	FC(*)	—	60%	—
Altice Finco S.A.	Luxembourg	FC(*)	—	100%	—
Altice Financing S.A.	Luxembourg	FC(*)	—	100%	—

(*) FC stands for "Full Consolidation"

ALTICE VII S.À R.L.
Notes to the consolidated financial statements (Continued)
December 31, 2012

3—Scope of consolidation (Continued)

3.2 Modification of the scope of consolidation

3.2.1 Main acquisitions in 2012

Altice Portugal S.A. acquired 100% of Cabovisao as at February 29, 2012, from Cogeco Cable Luxembourg Holding S.A.. The consideration amounted to EUR 45 million, of which 40% was subsequently sold to APAX in April 2013.

Goodwill allocation has been completed based on the accounts as at February 28, 2012.

While carrying out the purchase price allocation, the following identifiable assets have been identified:

Brands

The Cabovisao brand has been valued through the royalty relief method over an indefinite useful life and based upon following key parameters:

Discount rate amounts to 7%;

Royalty rate used amounts to 3%, consistent with the rates used for Coditel, Numericable and Everido;

Clients.

The portfolio of clients has been valued through the excess earnings approach, and basing upon following the key parameters:

Ebit margin rate: 21,59%;

Attrition rate: 20,81%;

Discount rate: 7%;

Acquired clients' growth rate: 0%.

3.2.2 Main companies' formation in 2012

The following companies were created during the period: Altice Caribbean S.à r.l., Altice Finco S.A., Altice Financing S.A. and Altice Portugal S.A.

3.3 Acquisitions of businesses

Business combinations that occurred during the reporting period are described in note 3.2.

ALTICE VII S.À R.L.
Notes to the consolidated financial statements (Continued)
December 31, 2012

3—Scope of consolidation (Continued)

The major classes of assets acquired and liabilities assumed at the acquisition date are:

	Total Business Combinations	Cabovisao
	(in millions of euros)	
Cost of acquisition	45,0	45,0
ASSET		
Intangible assets	37,8	37,8
Property, plant and equipment	123,0	123,0
Non-current financial assets	0,9	0,9
Inventories	—	—
Trade accounts receivable and other	6,5	6,5
Tax receivable	0,2	0,2
Cash and cash equivalents	9,0	9,0
Other current assets	1,6	1,6
Total assets	<u>178,9</u>	<u>178,9</u>
EQUITY AND LIABILITIES		
Non-current liabilities	37,7	37,7
Current liabilities	33,2	33,2
Total liabilities	<u>70,9</u>	<u>70,9</u>
Net assets	<u>108,0</u>	<u>108,0</u>
Residual badwill	(63,0)	(63,0)
<i>Including impact of non-controlling interests on badwill</i>	<i>(25,2)</i>	<i>(25,2)</i>

The impact of badwill has been recorded under the 'Depreciation and amortization' line item in the consolidated statement of income.

The main figures of the entity, since the beginning of the year, and until the business combination, are presented as follows:

	Cabovisao
	(in millions of euros)
Revenues	19,8
Cost of sales	(8,8)
Gross Profit	11,0
Other operating expenses	(4,5)
General and administrative expenses	(1,4)
Other sales and marketing expenses	(2,4)
Operating profit before depreciation and amortization	<u>2,6</u>
Depreciation and amortization	(0,8)
Other expenses, net	(0,3)
Operating profit	<u>1,5</u>
Profit for the period (including non-controlling interests)	1,4

ALTICE VII S.À R.L.
Notes to the consolidated financial statements (Continued)
December 31, 2012

4—Goodwill

	December 31, 2011	Business combinations	Impairment losses	Changes in foreign currency translation	December 31, 2012
	(in millions of euros)				
WSG	4,6	—	—	—	4,6
Valvision	1,4	—	—	—	1,4
Solutions 25/Green ch/Everido . . .	17,8	—	—	—	17,8
Coditel Brabant	209,2	—	—	—	209,2
Coditel S.à r.l.	86,4	—	—	—	86,4
Hot Telecom	600,2	—	—	1,6	601,8
Total Gross Value	919,4	—	—	1,6	921
WSG	(4,6)	—	—	—	(4,6)
Valvision	(1,4)	—	—	—	(1,4)
Solutions 25/Green ch/Everido . . .	—	—	—	—	—
Coditel Brabant	—	—	—	—	—
Coditel S.à r.l.	—	—	—	—	—
Hot Telecom	(1,6)	—	(121,9)	(0,7)	(124,2)
Total Cumulative impairment . . .	(7,5)	—	(121,9)	−0,7	(130,1)
WSG	—	—	—	—	—
Valvision	—	—	—	—	—
Solutions 25/Green ch/Everido . . .	17,8	—	—	—	17,8
Coditel Brabant	209,2	—	—	—	209,2
Coditel S.à r.l.	86,4	—	—	—	86,4
Hot Telecom	598,6	—	(121,9)	0,9	477,6
Total Net book value	911,9	—	(121,9)	0,9	790,9

ALTICE VII S.À R.L.
Notes to the consolidated financial statements (Continued)
December 31, 2012

4—Goodwill (Continued)

	December 31, 2010	Business combinations	Impairment losses	Changes in foreign currency translation	December 31, 2011
	(in millions of euros)				
WSG	4,6	—	—	—	4,6
Valvision	1,4	—	—	—	1,4
Solutions 25/Green ch/Everido . . .	17,8	—	—	—	17,8
Coditel Brabant	—	209,2	—	—	209,2
Coditel S.à r.l.	—	86,4	—	—	86,4
Hot Telecom	—	629,8	—	(29,6)	600,2
Total Gross Value	23,7	925,3	—	(29,6)	919,4
WSG	(4,6)	—	—	—	(4,6)
Valvision	(1,4)	—	—	—	(1,4)
Solutions 25/Green ch/Everido . . .	—	—	—	—	—
Coditel Brabant	—	—	—	—	—
Coditel S.à r.l.	—	—	—	—	—
Hot Telecom	—	(1,6)	—	0,1	(1,6)
Total Cumulative impairment . . .	(5,9)	(1,6)	—	0,1	(7,5)
WSG	—	—	—	—	—
Valvision	—	—	—	—	—
Solutions 25/Green ch/Everido . . .	17,8	—	—	—	17,8
Coditel Brabant	—	209,2	—	—	209,2
Coditel S.à r.l.	—	86,4	—	—	86,4
Hot Telecom	—	628,1	—	(29,5)	598,6
Total Net book value	17,8	923,7	—	(29,5)	911,9

Management monitors its different businesses by geography. The businesses are split into different geographies as mentioned below:

Israel

Belgium and Luxembourg

French overseas Territories

Switzerland

Others

In addition to this geographical split, for the purpose of the testing for impairment of goodwill and intangible assets with an indefinite useful life, the goodwill, brand name and customer relationships have been allocated to the local businesses that represent cash-generating units (CGU) as follows:

WSG

Valvision

Everido

Coditel Brabant

Coditel S.à r.l.

Hot Telecom

ALTICE VII S.À R.L.
Notes to the consolidated financial statements (Continued)
December 31, 2012

4—Goodwill (Continued)

Goodwill is tested at the cash-generating units (“CGU”) level for impairment annually, as of December 31, or whenever changes in circumstances indicate that the carrying amount may not be recoverable. In all cases, the CGU represents the lowest level at which goodwill is monitored for internal management purposes. The recoverable amounts of the CGUs are determined based on their value in use. The key assumptions for the value in use calculations are primarily the discount rates, growth rates, expected changes to telecom prices and direct costs during the period.

The value in use of each CGU was determined by estimating cash flows for a period of five years for the operating activities. Cash flow forecasts are derived from the most recent business plans approved by the Board of Managers. Beyond the specifically forecasted period of five years, the Company extrapolates cash flows for the remaining years based on an estimated constant growth rate between 1,5-2%. This rate does not exceed the average long-term growth rate for the relevant markets. Discount rates have been computed using WACC approach and range from 7% to 7,5%, except in Israel where it ranges from 10-11%.The Board of Managers estimates discount rates using pre-tax rates that reflect current market rates for investments of similar risk. The rate for each CGU was estimated from the weighted average cost of capital.

The Board of Managers has determined the value in use of each cash generating unit, with the assistance of an external appraiser, and as a result of this valuation the Group concluded that the recoverable amount of the Israeli in-country fixed line is lower than its carrying amount and accordingly recorded in the reporting period an impairment of approximately EUR 121,9 million which was recorded as part of section “depreciation and amortization”.

ALTICE VII S.À R.L.
Notes to the consolidated financial statements (Continued)
December 31, 2012

5—Other intangible assets

	December 31, 2011	Additions and related depreciation and amortization	Disposals	Business Combinations	Changes in foreign currency translation adjustment	Other	December 31, 2012
	(in millions of euros)						
Software	37,1	27,3	—	—	0,3	37,7	64,6
Brand name	50,0		—	29,6	0,2	5,3	79,8
Customer relations ⁽¹⁾	316,4		—	8,2	1,0	46,1	325,6
Licenses	19,2	13,2	(0,6)	—	—	(1,1)	32,0
Subscriber purchase costs ⁽²⁾	152,1	21,2	—	—	0,6	25,7	173,9
Intangible assets under construction	0,0	0,3	—	—	—	(0,3)	0,0
Other intangible assets	95,3	23,1	—	0,1	0,4	7,7	118,8
Total Gross Value	670,3	85,1	(0,6)	37,9	2,6	121,1	794,9
Software	(10,8)	(17,2)	0,2	—	(0,2)	(37,7)	(27,9)
Brand name	(1,1)	(1,5)	(0,6)	—	—	(5,3)	(2,7)
Customer relations ⁽¹⁾	(21,6)	(35,4)	—	—	(0,3)	(46,2)	(53,0)
Licenses	(7,1)	(2,9)	0,2	—	—	1,2	(9,9)
Subscriber purchase costs ⁽²⁾	(140,4)	(25,3)	—	—	(0,6)	(25,7)	(166,3)
Intangible assets under construction	—	—	—	—	—	—	—
Other intangible assets	(30,9)	(46,1)	—	—	(0,3)	(7,7)	(76,7)
Total Cumulative amortization and depreciation	(211,9)	(128,4)	(0,2)	0,0	(1,4)	(121,4)	(336,5)
Software	26,3	10,1	0,2	—	0,1	—	36,7
Brand name	48,9	(1,5)	(0,6)	29,6	0,2	—	77,2
Customer relations ⁽¹⁾	294,8	(31,0)	—	8,2	0,7	—	272,7
Licenses	12,1	10,3	(0,4)	—	—	—	22,1
Subscriber purchase costs ⁽²⁾	11,7	(4,1)	—	—	—	—	7,6
Intangible assets under construction	0,0	0,3	—	—	—	(0,3)	0,1
Other intangible assets	64,4	(12,8)	—	0,1	0,1	0,7	52,5
Total Net book value	458,3	(43,3)	—	37,9	1,2	0,5	468,8

ALTICE VII S.À R.L.
Notes to the consolidated financial statements (Continued)
December 31, 2012

5—Other intangible assets (Continued)

	December 31, 2010	Additions and related depreciation and amortization	Disposals	Business Combinations	Changes in foreign currency translation adjustment	Other	December 31, 2011
	(in millions of euros)						
Software	6,0	19,8	(0,1)	13,7	(2,3)	—	37,1
Brand name	16,4	0,1	—	34,6	(1,0)	—	50,0
Customer relations ⁽¹⁾	38,9	—	—	290,5	(13,0)	—	316,4
Licenses	8,9	9,2	—	1,3	(0,1)	—	19,2
Start-up costs	—	—	—	—	—	—	—
Research and development costs	—	—	—	—	—	—	—
Subscriber purchase costs ⁽²⁾	145,4	7,3	—	7,7	(8,4)	—	152,1
Intangible assets under construction	0,2	—	—	—	—	(0,2)	—
Other intangible assets	7,3	23,0	—	67,2	(2,3)	0,1	95,3
Total Gross Value	<u>223,2</u>	<u>59,4</u>	<u>(0,1)</u>	<u>414,9</u>	<u>(27,1)</u>	<u>(0,1)</u>	<u>670,3</u>
Software	(2,5)	(9,9)	0,1	—	1,6	—	(10,8)
Brand name	—	(0,7)	(0,6)	—	0,2	—	(1,1)
Customer relations ⁽¹⁾	(2,3)	(17,9)	(3,4)	—	1,9	—	(21,6)
Licenses	(6,1)	(1,1)	—	—	0,1	—	(7,1)
Start-up costs	—	—	—	—	—	—	—
Research and development costs	—	—	—	—	—	—	—
Subscriber purchase costs ⁽²⁾	(118,4)	(28,6)	—	—	6,6	—	(140,4)
Intangible assets under construction	—	—	—	—	—	—	—
Other intangible assets	(3,8)	(10,9)	(14,5)	—	(0,3)	—	(30,9)
Total Cumulative amortization and depreciation	<u>(133,1)</u>	<u>(69,1)</u>	<u>(18,4)</u>	<u>—</u>	<u>10,2</u>	<u>—</u>	<u>(211,9)</u>
Software	3,5	9,8	—	13,7	(0,7)	—	26,3
Brand name	16,4	(0,6)	(0,6)	34,6	(0,8)	—	48,9
Customer relations ⁽¹⁾	36,6	(17,9)	(3,4)	290,5	(11,1)	—	294,8
Licenses	2,7	8,1	—	1,3	—	—	12,1
Start-up costs	—	—	—	—	—	—	—
Research and development costs	—	—	—	—	—	—	—
Subscriber purchase costs ⁽²⁾	27,1	(21,3)	—	7,7	(1,8)	—	11,7
Intangible assets under construction	0,2	—	—	—	—	(0,2)	—
Other intangible assets	3,5	10,6	(14,5)	67,2	(2,6)	0,1	64,4
Total Net book value	<u>90,1</u>	<u>(11,2)</u>	<u>(18,5)</u>	<u>414,9</u>	<u>(16,9)</u>	<u>(0,1)</u>	<u>458,3</u>

(1) Customer relations have been valued on the basis of the fair value of the existing customers. The amortization expenses are in accordance with the benefits expected for each customers in each period.

(2) Subscriber purchase costs were recognized in respect of the costs of acquisition of subscribers (including additional sales commissions). The amortization expenses are linked to the length of the average commitment of the subscribers.

The majority of the intangible assets movements for the year ended December 31, 2012 are related to the Cabovisao business combination (see Note 3.3).

ALTICE VII S.À R.L.
Notes to the consolidated financial statements (Continued)
December 31, 2012

6—Property, Plant & Equipment

	December 31, 2011	Additions and related depreciation and amortization	Disposals	Business Combinations	Changes in foreign currency translation adjustment	Other	December 31, 2012
	(in millions of euros)						
Land	2,6	—	—	0,3	—	—	2,9
Buildings	55,5	12,3	12,3	0,5	0,3	14,1	68,6
Cable networks ⁽¹⁾	480,3	58,3	58,3	110,4	3	514,1	661,8
Call center (primarily electronic equipment) ⁽²⁾	68,3	25,8	25,8		0,7	148,6	94,9
Converters and modems .	161,8	70,4	70,4		1,5	249,2	230,5
Computers and ancillary equipment	29,1	6,4	6,4	0,1	0,2	32	35,8
Office furniture and equipment ⁽³⁾	97,7	12,2	12,2	0,7	0,2	162,3	113,9
Communication network infrastructure ⁽⁴⁾	301,9	58	58	3,1	1	0,4	362,1
Other data center equipment	3	(1,6)	(1,6)	—	—	1,8	3,3
Tangible assets under construction	7,2	19,8	19,8	8,4	—	(16,6)	17,0
Prepayments on tangible assets	0,1	3,0	3,0	—	—	—	3,1
Other tangible assets . . .	6,2	3,2	3,2	0,1	—	12,9	9,6
Total Gross Value	1 213,7	267,9	(8,8)	123,6	6,9	1118,8	1 603,4
Buildings	(8,7)	(4)	—	—	(0,1)	(14,1)	(12,8)
Cable networks ⁽¹⁾	(24,7)	(110,6)	0,8	—	(1,8)	(503,3)	(136,3)
Call center (primarily electronic equipment) ⁽²⁾	(5,8)	(19,6)	(0,8)	—	(0,5)	(148,5)	(26,7)
Converters and modems .	(11)	(44,9)	6,3	—	(0,9)	(249,3)	(50,6)
Computers and ancillary equipment	(20,4)	(5)	(2,0)	—	(0,2)	(32)	(27,6)
Office furniture and equipment ⁽³⁾	(23,7)	(15,2)	1,9	—	—	(158,8)	(37,0)
Communication network infrastructure ⁽⁴⁾	(212,3)	(28,2)	6,0	—	(0,5)	(0,1)	(235,1)
Other data center equipment	(1,1)	(0,3)	—	—	—	—	(1,5)
Tangible assets under construction	(0,1)	(0,3)	—	—	—	0,1	(0,3)
Prepayments on tangible assets	—	—	—	—	—	—	—
Other tangible assets . . .	(4,1)	(2,9)	(0,6)	—	—	(12,9)	(7,7)
Total Cumulative amortization and depreciation	(311,9)	(231,1)	11,5	—	(4,1)	(1 118,9)	(535,6)

ALTICE VII S.À R.L.
Notes to the consolidated financial statements (Continued)
December 31, 2012

6—Property, Plant & Equipment (Continued)

	December 31, 2011	Additions and related depreciation and amortization	Disposals	Business Combinations	Changes in foreign currency translation adjustment	Other	December 31, 2012
	(in millions of euros)						
Land	2,6	—	—	0,3	—	—	2,9
Buildings	46,8	8,2	—	0,5	0,2	—	55,8
Cable networks ⁽¹⁾	455,6	(52,2)	(0,1)	110,4	1,2	10,7	525,6
Call center (primarily electronic equipment) ⁽²⁾	62,6	6,3	(0,8)	—	0,2	—	68,2
Converters and modems .	150,8	25,5	3,0	—	0,6	—	179,9
Computers and ancillary equipment	8,7	1,4	(2,0)	0,1	—	—	8,2
Office furniture and equipment ⁽³⁾	74	(2,9)	1,3	0,7	0,1	3,7	76,8
Communication network infrastructure ⁽⁴⁾	89,6	29,7	3,6	3,1	0,5	0,4	127
Leasehold contracts	0	—	—	—	—	—	—
Other data center equipment	1,9	(1,9)	—	—	—	1,8	1,8
Tangible assets under construction	7,1	19,5	(1,8)	8,4	—	(16,4)	16,7
Prepayments on tangible assets	0,1	3,0	—	—	—	—	3,1
Other tangible assets . . .	2,0	0,3	(0,6)	0,1	—	—	1,9
Total Net book value . . .	<u>901,7</u>	<u>36,8</u>	<u>(2,6)</u>	<u>123,6</u>	<u>2,8</u>	<u>0,2</u>	<u>1 067,8</u>

ALTICE VII S.À R.L.
Notes to the consolidated financial statements (Continued)
December 31, 2012

6—Property, Plant & Equipment (Continued)

	December 31, 2010	Additions and related depreciation and amortization	Disposals	Business Combinations	Changes in foreign currency translation adjustment	Other	December 31, 2011
	(in millions of euros)						
Land	2,5	—	—	0,1	—	—	2,6
Buildings	17,9	13	—	14,6	(1,7)	11,7	55,5
Cable networks ⁽¹⁾	13	31,3	—	481,9	(45,9)	—	480,3
Call centers (primarily electronic equipment) ⁽²⁾ . .	—	14,1	—	64,9	(9,9)	—	68,3
Converters and modems . . .	0,7	30,1	-2	151,7	(18,6)	—	161,8
Computers and ancillary equipment	22,4	4,8	—	4,6	(2,6)	—	29,1
Office furniture and equipment ⁽³⁾	29,4	15,2	-1	43,6	0,4	10	97,7
Communication network infrastructure ⁽⁴⁾	288,3	24,9	—	—	(11,4)	—	301,9
Other data center equipment	2,2	0,7	—	—	0,1	—	3
Tangible assets under construction	21,8	6,4	—	—	0,3	(21,3)	7,2
Prepayments on tangible assets	0,5	—	—	—	—	(0,4)	0,1
Other tangible assets	3,6	0,5	—	2,8	(0,7)	—	6,2
Total Gross Value	402,3	141,1	(3,1)	763,3	(89,9)	—	1 213,7
Buildings	(6,1)	(3,4)	—	—	0,9	—	(8,7)
Cable networks ⁽¹⁾	(1,4)	(46,6)	—	—	23,3	—	(24,7)
Call center (primarily electronic equipment) ⁽²⁾ . .	—	(12,7)	—	—	6,9	—	(5,8)
Converters and modems . . .	(0,2)	(24,2)	1,8	—	11,6	—	(11)
Computers and ancillary equipment	(20,3)	(2,5)	—	—	2,3	—	(20,4)
Office furniture and equipment ⁽³⁾	(15,8)	(8,6)	0,9	—	(0,1)	—	(23,7)
Communication network infrastructure ⁽⁴⁾	(205,9)	(14,7)	—	—	8,3	—	(212,3)
Other data center equipment	(0,8)	(0,2)	—	—	—	—	(1,1)
Tangible assets under construction	—	(0,1)	—	—	—	—	(0,1)
Prepayments on tangible assets	—	—	—	—	—	—	—
Other tangible assets	(2,1)	(2,5)	—	—	0,5	—	(4,1)
Total Cumulative amortization and depreciation	(252,7)	(115,5)	2,7	—	53,5	—	(311,9)

ALTICE VII S.À R.L.
Notes to the consolidated financial statements (Continued)
December 31, 2012

6—Property, Plant & Equipment (Continued)

	December 31, 2010	Additions and related depreciation and amortization	Disposals	Business Combinations	Changes in foreign currency translation adjustment	Other	December 31, 2011
	(in millions of euros)						
Land	2,5	—	—	0,1	—	—	2,6
Buildings	11,8	9,5	—	14,6	(0,8)	11,7	46,8
Cable networks ⁽¹⁾	11,6	(15,2)	—	481,9	(22,6)	—	455,6
Call center (primarily electronic equipment) ⁽²⁾ . .	—	1,4	—	64,2	(3)	—	62,6
Converters and modems . . .	0,5	5,9	(0,2)	151,7	(7,1)	—	150,8
Computers and ancillary equipment	2,1	2,3	—	4,6	(0,3)	—	8,7
Office furniture and equipment ⁽³⁾	13,5	6,6	(0,1)	43,6	0,3	10	74
Communication network infrastructure ⁽⁴⁾	82,4	10,2	—	—	(3,1)	—	89,6
Leasehold contracts	—	—	—	—	—	—	—
Other data center equipment	1,4	0,4	—	—	—	—	1,9
Tangible assets under construction	21,8	6,3	—	—	0,3	(21,3)	7,1
Prepayments on tangible assets	0,5	—	—	—	—	(0,4)	0,1
Other tangible assets	1,5	(2,1)	—	2,8	80,2	—	2
Total Net book value	<u>149,7</u>	<u>25,6</u>	<u>(0,4)</u>	<u>763,3</u>	<u>(36,4)</u>	<u>—</u>	<u>901,7</u>

(1) Cable network: the Group owns, directly and indirectly through its subsidiaries, cable or fibre network which allow it to supply cable-based pay television, broadband internet and fixed-line telephony services to its subscribers.

(2) Call center represents centralized offices used for the purpose of receiving or transmitting a large volume of administrative, technical or commercial requests by telephone.

(3) Office furniture and equipment refers to furnishings and IT equipment.

(4) The Communication network infrastructure includes the digital technologies for the transmission of multi-channel television services.

Most of the tangible assets increases as of December 31, 2012 is related to the Cabovisao business combination (see Note 3.3).

The additions in capital expenditures come mainly from Hot Telecom activity:

- Modems and converters related capital expenditures represented EUR 69,4 million for the year ended December 31, 2012, as compared to EUR 29,3 million for the year ended December 31, 2011. The increase in converters and modems related capital expenditures resulted from capital expenditure incurred during the first two quarters of 2012 relating to our new set top boxes (HOT Magic HD) for which delivery was delayed and which we had expected to incur during the second quarter of 2011 and did not received until the last quarter of 2011.
- Cable network related (including centers) capital expenditures represented EUR 84 million for the year ended December 31, 2012, as compared to EUR 51.6 million for the year ended December 31, 2011. The increase in our total cable network related (including centers) capital expenditure was as a result of the expenditure incurred to complete the upgrade to 100Mb capacity throughout our cable network and fiber roll out in certain areas in 2012.

ALTICE VII S.À R.L.
Notes to the consolidated financial statements (Continued)
December 31, 2012

7—Financial assets

	December 31, 2012	December 31, 2011
	(in millions of euros)	
Investments held as available for sale ⁽¹⁾	6,1	8,5
Loan term trade receivables ⁽³⁾	18,7	2,4
Restricted cash ⁽²⁾	9,6	41,4
Total Gross Value	34,4	52,3
Assets available for sale ⁽¹⁾	—	—
Loan term trade receivables ⁽³⁾	—	—
Restricted cash ⁽²⁾	—	—
Total Cumulative amortization and depreciation	—	—
Investments held as available for sale ⁽¹⁾	6,1	8,5
Loan term trade receivables ⁽³⁾	18,7	2,4
Restricted cash ⁽²⁾	9,6	41,4
Total Net book value	34,4	52,3

(1) Investment in available for sale financial asset:

A subsidiary company, operating through Hot Net Internet Services Ltd. (formerly Hot Properties) and Finance Ltd. (hereinafter—Hot Net) holds 1 454 663 regular shares in Partner Communications Ltd. (hereinafter—Partner), constituting approximately 0,9% of Partner’s share capital which is engaged in the provision of mobile communications services and whose shares are traded on stock exchanges in the United States of America, in the United Kingdom and in Israel.

Partner’s shares are subject to Israeli restrictions in accordance with the Radio Mobile Telephone license that was granted to Partner, in accordance with which the shares can only be sold to an Israeli buyer, as defined in the said license.

The subsidiary companies present the investment in Partner as an investment in an available for sale financial asset, which is measured at fair value.

(2) Restricted cash (see Note 2.18).

As of December 31, 2012 the cash is restricted for the purpose of collateralizing HOT’s liabilities to banking entities. The restricted cash has been deposited in financial institutions and as of the statement of financial position date it bears interest based on the interest rate on daily bank deposits.

(3) On July 3, 2012, Altice Africa S.à r.l., as investor, entered into a convertible note purchase agreement with Wananchi Group (Holdings), Ltd (hereafter “WGH”) for a principal amount of up to EUR 16 million. The promissory notes ((hereafter “the notes”) plus any interest accrued shall be converted and capitalized into fully paid ordinary shares of WGH before the maturity date on December 31, 2012. In December 2012, it was decided to extend the maturities of the promissory notes till January 31, 2013. Hence the notes were treated as a loan to a related party and accrued interest (15% per annum, retroactive to the date of issue) was recognized on these notes in the accounts.

ALTICE VII S.À R.L.
Notes to the consolidated financial statements (Continued)
December 31, 2012

8—Other long-term trade receivables

	December 31, 2012	December 31, 2011
	(in millions of euros)	
Income taxes	—	—
Prepaid expenses	0,8	5,9
Other current receivables ⁽¹⁾	23,7	22,5
Total Gross Value	24,6	28,4
Income taxes	—	—
Prepaid expenses	—	—
Other current receivables ⁽¹⁾	—	—
Total Cumulative amortization and depreciation	—	—
Income taxes	—	—
Prepaid expenses	0,8	5,9
Other current receivables ⁽¹⁾	23,7	22,5
Total Net book value	24,6	28,4

(1) The balance reflects customer's debts in respect of the sale of devices under long-term credit terms (sales in installments). The balance of the debt is presented at its value, as discounted using an interest rate of 5% for a period of up to 36 months, less the current maturities, which are presented under trade receivables.

9—Inventories

	December 31, 2012	December 31, 2011
	(in millions of euros)	
Work in progress	0,1	0,1
Finished/semi-finished goods	7,1	7,9
Total Gross Value	7,2	8,0
Work in progress	(0,1)	—
Finished/semi-finished goods	(1,0)	(1,9)
Total Cumulative amortization and depreciation	(1,1)	(1,9)
Work in progress	—	0,1
Finished/semi-finished goods	6,2	6,1
Total Net book value	6,1	6,1

Movement for allowance for obsolescence of inventory or slow moving inventory:

	December 31, 2011	Business Combinations	Reversal	Divestitures, changes in foreign currency translation adjustments and other	December 31, 2012
	(in millions of euros)				
Work in progress (goods)	—	(0,1)	—	—	(0,1)
Finished/semi-finished goods	(1,9)	—	0,9	—	(1,0)
Total Cumulative amortization and depreciation	(1,9)	(0,1)	—	—	(1,1)

ALTICE VII S.À R.L.
Notes to the consolidated financial statements (Continued)
December 31, 2012

9—Inventories (Continued)

	December 31, 2010	Business Combinations	Reversal	Divestitures, changes in foreign currency translation adjustments and other	December 31, 2011
	(in millions of euros)				
Finished/semi-finished goods	(0,6)	(1,3)	—	—	(1,9)
Total Cumulative amortization and depreciation	<u>(0,6)</u>	<u>(1,3)</u>	<u>—</u>	<u>—</u>	<u>(1,9)</u>

10—Trade and other receivables

10.1 Trade receivables

	December 31, 2011	Business Combinations	Addition	Reversal	Divestitures, changes in foreign currency translation adjustments and other	December 31, 2012
	(in millions of euros)					
Trade receivables	129,1	5,9	40,4	—	0,1	175,6
Allowance for doubtful debts	(26,4)	—	(3,0)	4,4	0,2	(24,8)
Trade receivable, net	<u>102,7</u>	<u>5,9</u>	<u>37,4</u>	<u>4,4</u>	<u>0,3</u>	<u>150,8</u>

	December 31, 2010	Business Combinations	Addition	Reversal	Divestitures, changes in foreign currency translation adjustments and other	December 31, 2011
	(in millions of euros)					
Trade receivables	60,8	62,2	8,1	—	(2,0)	129,1
Allowance for doubtful debts	(9,9)	(14,7)	(4,0)	1,5	0,8	(26,4)
Trade receivable, net	<u>50,9</u>	<u>47,5</u>	<u>4,1</u>	<u>1,5</u>	<u>(1,2)</u>	<u>102,7</u>

The increase in trade receivables in the year ended December 31, 2012 is explained by the switch in invoicing method in Israel from invoicing before the service was provided, to invoicing post utilization of the service, as decided by the Israeli Ministry of Telecom.

10.2 Age of receivables that are past due but not impaired

	December 31, 2012	December 31, 2011
	(in millions of euros)	
Not yet payable	116,7	78,3
30 - 90 days	14,0	10,1
91 - 121 days	20,2	14,3
Total	<u>150,8</u>	<u>102,7</u>

ALTICE VII S.À R.L.
Notes to the consolidated financial statements (Continued)
December 31, 2012

10—Trade and other receivables (Continued)

10.3 Other receivables

	December 31, 2012	December 31, 2011
	(in millions of euros)	
Loans to related party	3,8	1,8
Bank guarantee	14,0	—
Tax and social security receivables	5,5	5,1
Income tax	0,3	—
Prepaid expenses	6,1	4,3
Other current receivables	8,1	10,9
Total	<u>37,9</u>	<u>22,1</u>

The Group provides services on credit for an average of 16 days, 24 days and 96 days in average to its customers in the cable television field, the in-country fixed line communications field and the mobile communication field, respectively. The Group routinely evaluates the credit that is provided to its customers, while checking their financial situations; however it does not demand collateral for those debts. The Group records a provision for doubtful debts, based on the factors that affect the credit risks of certain customers, past experience and other information.

The increase in other receivables in the year ended December 31, 2012 is mainly explained by an increase in bank guarantees provided by HOT Mobile to the national regulator in Israel, for a total amount of EUR 14 million (NIS 69 million), related to the expansion of its mobile network.

11—Cash and cash equivalents

	December 31, 2012	December 31, 2011
	(in millions of euros)	
Time deposits	5,2	0,1
Bank balances	124,5	19,7
Cash equivalents	129,7	19,8
Bank overdrafts	—	—
Bank overdrafts	—	—
Cash and cash equivalents presented in the consolidated statement of cash flows	<u>129,7</u>	<u>19,8</u>

12—Issued capital

On December 31, 2012, the share capital amounts to EUR 7,4 million and is divided into 742 561 510 fully paid shares with a nominal value of EUR 0,01.

	December 31, 2012	December 31, 2011
	(in millions of euros)	
Share capital	7,4	7,4
Total	<u>7,4</u>	<u>7,4</u>

The details of the different classes of shares are provided in the table below. The Group has defined three share classes; Shares designated with the letters A through H are referred to as specific shares. Shares designated 1A through 1H are referred to as class 1 shares and when grouped together with their corresponding letters (i.e. Class A shares with class 1A shares), form a share category referred to as the

ALTICE VII S.À R.L.
Notes to the consolidated financial statements (Continued)
December 31, 2012

12—Issued capital (Continued)

specific share class (*'classe spécifique'*). In addition to this class, the other two classes of shares are: Ordinary shares (*'part sociale ordinaire'*) and Class M shares (*'classe M'*) shares. All these shares put together make up the total shares of the Group.

Each specific share class is linked to the investment in the assets of companies acquired by the Group and hence intrinsically linked to the financial performance of these entities (tracking shares). Each specific class allows its holder to obtain a share of the net profit of the Group in a proportion determined by the Board of Managers.

In addition to the profit sharing defined above, the economic benefit arising from investment in any of the specific share classes is determined as follows:

At the end of the financial year, the Group reports a net income from its activities and based on this net income could attribute it to the different specific classes, as if the investment to which they are related were the only asset held by the Group. Any profits arising from this distribution could be credited to a specific account. Thus, a separate account must be maintained for each specific share class.

Dividends may be issued from these accounts only to the holders of the shares linked to each account.

Holders of ordinary and class M shares are eligible to receive a share of profits, if any such profits remain after distribution to the holders of the specific share classes. None of the class of shares are subordinated to each other.

Each share class allows the holder one right to vote in general assembly meetings, provided that there is one single representative holder of the share class. If shares in a class are held by more than one person, the voting right is suspended till the holder designates a single legal representative.

Different classes of shares are summarized below:

December 31, 2012	
Class of corporate units	Number
Class A	14 832 900
Class B	71 747 100
Class C	98 886 400
Class D	64 226 800
Class E	98 886 400
Class F	98 886 400
Class G	1 058 610
Class 1A	1 113 600
Class 1B	5 386 000
Class 1C	202 108 900
Class 1D	4 603 900
Class 1E	19 337 000
Class 1F	25 657 900
Class 1O	44 600
Class 1G	79 600
Class M	31 000 000
Class H	742 868
Class 1H	7 132
Ordinary	3 955 400

ALTICE VII S.À R.L.
Notes to the consolidated financial statements (Continued)
December 31, 2012

12—Issued capital (Continued)

Class of corporate units	December 31, 2011	
	Number	
Class A	14 832 900	
Class B	71 747 100	
Class C	98 886 400	
Class D	64 226 800	
Class E	98 886 400	
Class F	98 886 400	
Class G	1 058 610	
Class M	31 000 000	
Class 1A	1 113 600	
Class 1B	5 386 000	
Class 1D	4 603 900	
Class 1E	19 337 000	
Class 1F	25 657 900	
Class 1O	44 600	
Class 1G	79 600	
Ordinary	3 955 400	
	December 31,	December 31,
	2012	2011
	Number of shares	
Opening balance	741 811 510	783 283 510
Issuance	750 000	124 200
Redemption	0	(41 596 200)
Closing balance	742 561 510	741 811 510

In 2012, the extraordinary general meeting of the equity holders decided to conduct three capital increases for a total amount of EUR 0,01 million through the issuance of 742 868 class H units and 7 132 class 1H units.

13—Earnings per share (EPS)

Non diluted EPS for 2012 has been computed dividing 2012's net income by weighted average number of shares as of December 31, 2012.

Diluted EPS for 2012 has been computed based on the assumption that the CPECs (Convertible Preferred Equity Certificates) would be converted at a 1 to 1 ratio.

	December 31, 2012	December 31, 2011
Net income (in millions of euros)	(189,80)	123,90
Non diluted weighted average number of shares	742 417 674	742 417 674
Basic earnings per share	(0,26)	0,17
Diluted weighted average number of shares	967 944 738	967 944 738
Diluted earnings per share	(0,20)	0,13

In June 2013, all the different classes of tracking shares were merged into one single class of ordinary shares. No dividends were paid to any of the equity holders during any period since the inception of the Group. The Board of Managers has determined that the disclosure of EPS metrics for each class of share in issuance during 2011 and 2012 is not qualitatively relevant to the users of the financial statements and has hence elected to disclose EPS on the basis of the merged single class of ordinary shares.

ALTICE VII S.À R.L.
Notes to the consolidated financial statements (Continued)
December 31, 2012

14—Reserves

	December 31, 2012	December 31, 2011
	(in millions of euros)	
CPEC'S reclassified in equity	219,1	219,1
Distribution to CPEC's holders	(17,4)	(17,4)
YFPEC'S	22,7	21,6
Employee benefits	0,3	0,2
Currency Translation Reserve	(6,7)	(3,0)
Impact of changes in ownership interests	61,3	13,1
Other	(1,6)	(0,7)
Group reserves	<u>277,5</u>	<u>232,9</u>

According to the Luxembourg legal provisions, 5% of net profits must be obligatorily credited to a legal reserve account. The obligation to make this contribution ends when the legal reserves equal 10% or more of the share capital of the Group. An allocation to the legal reserve has been performed for the year ended December 31, 2012 for an amount of EUR 277 thousands and is not distributable to the equity holders of the Company.

CPEC, which maturity comprises between 2058 and 2061, increases from EUR 219 million in 2011 to EUR 219,1 million in 2012, due to subscriptions of EUR 0,1 million. In substance, CPECs subordinated financial instruments (about EUR 219,1 million as at the end of 2011) are equity instruments as:

CPECs give issuer the opportunity to avoid delivering cash.

CPECs do not bear interests.

The YFPECs have been valued using a discount rate of 4,76% given its preferred interest rate which therefore values the liabilities at EUR 4,4 million as at December 31, 2012.

The change in impact from changes in ownership structure are explained by the buyout of minority interests in HOT in December 2012, following the take private of HOT (see note 27).

ALTICE VII S.À R.L.
Notes to the consolidated financial statements (Continued)
December 31, 2012

14—Reserves (Continued)

Details of YFPECS (before impact of discounting) and CPECS are presented as follows:

<u>Name</u>	<u>Maturity date</u>	<u>Interest rate</u>	<u>Convertible</u>	<u>Principal amount as at the end 2011</u>	<u>Principal amount as at the end 2012</u>
				<u>in millions of euros</u>	
YFPECS C	14/05/2058	—	No	22,07	22,07
YFPECS C	03/12/2058	—	No	4,51	4,51
YFPECS C	15/06/2060	—	No	0,10	0,10
YFPECS C	26/08/2011	—	No	0,11	0,11
YFPECS C	28/11/2011	—	No	2,51	2,51
YFPECS C	03/12/2058	—	No	4,00	4,00
YFPECS E	01/12/2058	—	No	1,88	1,88
YFPECS F	17/06/2059	—	No	—	—
YFPECS K	31/12/2061	—	No	—	1,16
Total				<u>35,18</u>	<u>36,34</u>
CPECS A	14/05/2058	—	Yes (to the benefit of the issuer)	0,84	0,84
CPECS B	01/12/2058	—	Yes (to the benefit of the issuer)	3,61	3,61
CPECS B	14/05/2058	—	Yes (to the benefit of the issuer)	0,46	0,46
CPECS B	14/05/2058	—	Yes (to the benefit of the issuer)	15,42	15,42
CPECS C	03/12/2058	—	Yes (to the benefit of the issuer)	23,48	23,48
CPECS C	03/12/2058	—	Yes (to the benefit of the issuer)	22,67	22,67
CPECS C	14/05/2058	—	Yes (to the benefit of the issuer)	132,30	132,30
CPECS D	03/12/2058	—	Yes (to the benefit of the issuer)	3,45	3,45
CPECS E	01/12/2058	—	Yes (to the benefit of the issuer)	16,18	16,18
CPECS F	01/12/2058	—	Yes (to the benefit of the issuer)	—	—
CPECS G	18/03/2058	—	Yes (to the benefit of the issuer)	0,06	0,06
CPECS H	29/06/2058	—	Yes (to the benefit of the issuer)	—	0,45
CPECS H	16/11/2060	—	Yes (to the benefit of the issuer)	—	0,01
CPECS H	01/12/2060	—	Yes (to the benefit of the issuer)	—	0,15
CPECS I	29/02/2061	—	Yes (to the benefit of the issuer)	—	0,03
Total				<u>219,0</u>	<u>219,1</u>

Information on the parameters used to calculate the employee benefits is presented in note 16.

Exchange rate differences relating to the translation of the results and net assets of the Group's foreign operations from their functional currencies to the Group's presentation currency are recognized directly in other comprehensive income and accumulated in the foreign currency translation reserve.

Exchange differences previously accumulated in the foreign currency translation reserve (in respect of translating both the net assets of foreign operations and hedges of foreign operations) are reclassified to profit or loss on the disposal of the foreign operation.

ALTICE VII S.À R.L.
Notes to the consolidated financial statements (Continued)
December 31, 2012

15—Provisions

	<u>December 31, 2011</u>	<u>Business Combinations</u>	<u>Addition</u>	<u>Utilization</u>	<u>Divestitures, changes in foreign currency translation adjustments and other</u>	<u>December 31, 2012</u>
			(in millions of euros)			
Provision for retirement benefits	6,9	—	2,0	(0,8)	1,0	9,1
Litigations ⁽¹⁾	38,8	—	1,9	(24,0)	(0,9)	15,8
Other risks ⁽²⁾	1,7	5,0	1,4	(0,1)	(0,1)	8,0
Provisions for other expenses	—	—	1,8	—	—	1,8
TOTAL	<u>47,4</u>	<u>5,1</u>	<u>7,1</u>	<u>(24,9)</u>	<u>0,1</u>	<u>34,7</u>

	<u>December 31, 2010</u>	<u>Business Combinations</u>	<u>Addition</u>	<u>Utilization</u>	<u>Divestitures, changes in foreign currency translation adjustments and other</u>	<u>December 31, 2011</u>
			(in millions of euros)			
Provision for retirement benefits	1,2	5,4	0,4	(2,5)	2,4	6,9
Litigations ⁽¹⁾	0,7	67,4	0,7	(26,6)	(3,4)	38,8
Other risks ⁽²⁾	0,8	0,9	—	—	—	1,7
Provisions for other expenses	0,2	—	—	(0,2)	—	—
TOTAL	<u>2,9</u>	<u>73,7</u>	<u>1,1</u>	<u>(29,3)</u>	<u>(0,9)</u>	<u>47,4</u>

(1) Provisions for litigations and other risks decreased in FY12 compared to the previous period, mainly driven by a re-evaluation of the risk of pay-out on the various royalty and retransmission fees related lawsuits faced by HOT Telecom in Israel. The reversals on the three major litigations, namely TALI, AKUM and AGICOA, amounted to EUR 3, 13,5 and 3,5 million respectively. The total reversal on provision for litigation was EUR 20 million.

In 2012, HOT Telecom also recorded an additional provision of EUR 1,9 million to cover a contested withholding tax ruling.

(2) No major movements were recorded on provisions for risks in the French Caribbean entities. The increase in provisions for risk in FY12 was mainly attributed to the acquisition of Cabovisao in February 2012. Cabovisao had a provision of EUR 5 million on its statement of financial position to account for potential fines and penalties to be paid resulting from negative outcome on various tax rulings sought by Cabovisao.

16—Employee benefits

Breakdown of the employee benefits by entity:

	<u>Notes</u>	<u>December 31, 2012</u>	<u>December 31, 2011</u>
		(in millions of euros)	
Coditel Brabant		0,7	0,9
Hot Telecom	16.1	6,5	4,7
Solutions 25		2	1,4
Total		<u>9,1</u>	<u>6,9</u>

ALTICE VII S.À R.L.
Notes to the consolidated financial statements (Continued)
December 31, 2012

16—Employee benefits (Continued)

16.1 Hot Telecom

(a) Defined Benefit Plans

The portion of the severance pay payments that is not covered by deposits, is treated by the Group as a defined benefit plan in accordance with which a liability is recorded in respect of employee benefits, and the Group deposits amounts in central severance pay funds and in appropriate insurance policies in respect of it.

The Group has defined contribution plans, in accordance with section 14 of the Israeli Severance Pay Law, in accordance with which the Group makes regular payments without it having a legal or implicit commitment to pay additional payments even if sufficient funds have not accumulated in the funds to pay all of the benefits to an employee that relate to the employee's employment in the current period and in previous periods.

Deposits in a defined contribution plan in respect of severance pay or in respect of emoluments are recognized as expense at the time of the deposit in the plan, in parallel to the receipt of the labor services from the employee and no additional provision is required in the financial statements.

(b) Expenses reflected in the statement of comprehensive income

	December 31, 2012	December 31, 2011
	(in millions of euros)	
Current service cost	4,7	3,9
Interest expenses in respect of the benefit liabilities	1,0	1,0
Expected yield in the plan assets	(0,8)	(0,8)
Net actuarial loss (gain) which has been recognized in the year	0,6	2,4
Total expenses in respect of employee benefit	<u>5,5</u>	<u>6,5</u>

(c) The plan assets (liabilities)

	December 31, 2012	December 31, 2011
	(in millions of euros)	
Liabilities in respect of a defined benefit plan	26,8	25,4
Fair value of the plan assets	<u>(20,3)</u>	<u>(20,7)</u>
Total net assets/(liabilities)	<u>6,5</u>	<u>4,7</u>

(d) Changes in the present value of the liability in respect of a defined plan

	December 31, 2012	December 31, 2011
	(in millions of euros)	
Opening balance	25,4	23,8
Interest expenses	1,0	1,0
Current service cost	4,7	3,9
Benefits paid	(3,2)	(4,1)
Transfer of employees to section 14	(1,6)	—
Net actuarial loss (profit)	0,6	0,8
Closing balance	<u>26,8</u>	<u>25,4</u>

ALTICE VII S.À R.L.
Notes to the consolidated financial statements (Continued)
December 31, 2012

16—Employee benefits (Continued)

(e) The plan assets

The plan assets

The plan assets include assets that are held by a long-term employee benefit fund as well as in appropriate insurance policies.

The movement in the fair value of the plan assets

	December 31, 2012	December 31, 2011
	(in millions of euros)	
Opening balance	20,7	20,1
Expected yield	0,8	0,8
Deposits by the employer into the plan	4,1	3,9
Benefits paid	(3,7)	(2,4)
Transfer of employees to section 14	(1,6)	—
Net actuarial loss	—	(1,6)
Closing balance	<u>20,3</u>	<u>20,7</u>

(f) The principal assumptions:

	December 31, 2012	December 31, 2011
	(in %)	
Discount rate	3,54	4,34
Expected yield on the plan assets	3,84	4,51
Expected yield of salary increases	2 - 4	2 - 4

17—Borrowings and other financial liabilities

Total financial liabilities are broken down as follows:

	December 31, 2012	December 31, 2011
	(in millions of euros)	
Bonds	1 108,5	291,4
Related party bonds	109	73,9
Bank credit facilities	257,2	536,6
Finance leases	7,4	7,3
Other financial liabilities	111	85,3
Financial instruments	62,5	—
Non-current liabilities	1 655,6	994,4
Bonds	25,4	12,4
Bank credit facilities	86,5	228,8
Finance leases	1,4	0,6
Bank overdraft	—	—
Other financial liabilities	—	0,7
Accrued interest	2,7	2,2
Current liabilities	<u>116,3</u>	<u>244,7</u>

ALTICE VII S.À R.L.
Notes to the consolidated financial statements (Continued)
December 31, 2012

17—Borrowings and other financial liabilities (Continued)

17.1 Financial liabilities description

During the year ended December 31, 2012, bonds include the debentures in Hot Telecom:

The Series A' debentures—EUR 167 million (NIS 825 million par value), linked to the Consumer Prices Index for the month of February, 2011, that bear interest at a rate of 3,9% a year. Series A' debentures are repayable in 13 semi-annual payments commencing on September 30, 2012 and up to September 30, 2018.

The Series B' debentures—EUR 137 million (NIS 675 million par value) that bear interest at a fixed rate of 6,9% a year. Series B' debentures are repayable in 13 semi-annual payments commencing on September 30, 2012 and up to September 30, 2018.

Bonds also include Senior and Senior secured Notes in Altice Finco S.A. and Altice Financing S.A.:

The Senior Notes in U.S. dollar, issued by Altice Finco S.A and with a face value of \$425,0 million (EUR 322,0 million) mature on December 15, 2020 and bear coupons of 9,875% annually.

The Senior Secured Notes in U.S. dollars, issued by Altice Financing S.A. and with a face value of \$460 (EUR 348,5 million) mature on December 15, 2019 and bear coupons of 7,875% annually.

The Senior Secured Notes in Euro, issued by Altice Financing S.A and with a face value of EUR 210 million mature on December 15, 2019 and bear coupons of 8% annually.

The Senior and Senior Secured Notes are listed on the Official List of the Luxembourg Stock Exchange and traded on the Euro MTF Market of the Luxembourg Stock Exchange. The interest payment of the bonds is semi-annually on June 15 and on December 15 of each year and the first payment of the interest will be on June 15, 2013.

17.1.1 Hot Telecom

The unsecured debentures issued on the Tel Aviv stock exchange by the Group's subsidiary Hot Telecom include financial covenants measured on Hot Telecom performance, which mainly include:

a debt to EBITDA ratio, which is not to exceed 6 for a period that exceeds two consecutive quarters;

no distribution of a dividend when Hot Telecom exceeds a debt to EBITDA ratio of 5.5.

As of December 31, 2012, Hot Telecom was in compliance with all of the required financial covenants.

17.1.2 Altice Blue One

As part of the Altice Blue One ("ABO") financing arranged in 2009, the ABO was required to respect certain covenants calculated on the basis of its consolidated accounts. As of December 31, 2012, the company was in default of financial covenants, though it was not in default of any scheduled payments due to the lenders. As per the debt contracts, one consequence of this default could be early or accelerated repayment of the debts, if and only if such repayments are unanimously reclaimed by all of the lending agencies.

ABO's management does not believe that these covenant defaults affect in any way the ability of the Group to effectively pursue its operations. This hypothesis was supported by advanced level talks with the lending parties, and based on the fact that none of the lenders ever demanded early repayment of the loan. Thus ABO's accounts for 2012 were closed and approved based on the hypothesis outlined above. On July 2, 2013, ABO refinanced the relevant facilities with funds granted by the Group, thereby solving any default situation.

ALTICE VII S.À R.L.
Notes to the consolidated financial statements (Continued)
December 31, 2012

17—Borrowings and other financial liabilities (Continued)

17.1.3 Coditel Holding

Financial covenants have been set for Coditel Holding, in the framework of the financing agreement entered into with a pool of financial institutions on December 2, 2011, based on the consolidated accounts of Coditel Holding S.A..

As of December 31, 2012, Coditel Holding S.A. was in compliance with all of the required financial covenants.

As at December 31, 2012, there were no breaches of covenants for the senior and senior secured notes mentioned in the note above.

17.2 Bonds

Issuer	Fair value in millions of euros December 31, 2012	Effective interest rate	Year of maturity	Carrying amount December 31, 2012	Carrying amount December 31, 2011
Bonds					
Hot Telecom					
—Debentures	269,2	Variable (3,9% and 6,9% + Consumer Price Index)	2018	269,2	291,4
Altice Financing					
—Senior Secured Notes	516,7	between 7,9% and 9,9%	2019/2020	516,7	
Altice Finco					
—Senior Secured Notes	322,7	between 7,9% and 9,9%	2019/2020	322,7	
Related party bonds					
Altice VII					
—Alpecs	104,6	Variable	2057 to 2061	104,6	69,8
—Yfpecs	4,4	4,76%	2058 to 2061	4,4	4,1
Nominal value of bonds	1 322,6			1 217,6	365,3
Of which due within one year . .					
Of which due after one year . . .	1 322,6			1 217,6	365,3

The fair value of bonds amounts to EUR 1 322,6 million (2011: EUR 418 million). This value includes accrued interest of EUR 9,02 million on Alpecs (Altice VII) and EUR 8,6 million on Pecs (Coditel holding).

17.3 Related party bonds

Subordinated financial instruments have been issued by Altice VII and Coditel Holding.

(a) Altice VII

Subordinated financial instruments have been issued by Altice VII consists of:

YFPECs: Yield Free Preferred Equity Certificates;

ALPECS: Asset Linked Preferred Equity Certificate;

ALTICE VII S.À R.L.
Notes to the consolidated financial statements (Continued)
December 31, 2012

17—Borrowings and other financial liabilities (Continued)

ALN: Asset Linked Notes.

Conversely, according to our appreciation, and upon a strict application of IAS 32/39, following instruments have to be classified as debt instruments:

ALPECs instruments (about EUR 101,3 Million as at the end of 2012);

YFPECs instruments (about EUR 36,3 Million as at the end of 2012).

The YFPECs have been valued using a discount rate of 4,76% given its preferred interest rate which therefore values the liabilities at EUR 4,4 million as at December 31, 2012.

Details of ALPECs are summarized in the table below:

<u>Name</u>	<u>Maturity date</u>	<u>Interest rate</u>	<u>Convertible</u>	<u>Principal amount as at the end 2011</u>	<u>Principal amount as at the end 2012</u>
				(in millions of euros)	
ALPECs A	14/05/2058	Loan Auberimmo—25 bp	No	1,0	1,0
ALPECs B1	31/12/2057	Loan ABO—25 bp	No	4,5	4,5
ALPECs B3	31/07/2058	Loan ICC France—25 bp	No	1,0	—
ALPECS F (US dollar) . .	27/05/2059	Loan Mirs—25 bp	No	—	—
ALPECS H	16/11/2060	Business Unit ⁽¹⁾ —25 bp	No	59,0	69,0
ALPECS I	28/02/2061		No		11,2
ALPECS J	03/08/2061		No		4,0
ALPECS J	02/10/2061		No		8,0
ALPECS J	13/11/2061		No		4,0
Total				<u>65,5</u>	<u>101,3</u>

(1) Business Unit means any interests and proceeds received by the Issuer by virtue of the Subsidiary's PECs. Each instrument class is linked to the acquisition of a specific asset. This asset makes up the business unit mentioned earlier in the footnote.

(b) Coditel Holding

Subordinated financial instruments in Coditel Holding S.A. consist of PECs (Preferred Equity Certificates). Each PEC bears a yield and shall have a maturity of 49 years.

As at the end of 2012, the total of PECs instruments amounts to EUR 61,8 million (including interests):

<u>Name</u>	<u>Issuing date</u>	<u>Maturity date</u>	<u>Number of instruments</u>	<u>Nominal value per instrument in euro</u>	<u>Interest rate</u>	<u>Convertible</u>	<u>Amount as at the end of 2011</u>	<u>Amount as at the end of 2012</u>
			(in millions)	(in euro)			(in millions of euros)—including interests	
PECs C . .	30/06/2011	30/06/2060	44,2	1	12,98%	No	44,2	51,4
PECs C . .	02/12/2011	02/12/2060	9	1	12,98%	No	9	10,5
Total			<u>53,2</u>				<u>53,2</u>	<u>61,8</u>

ALTICE VII S.À R.L.
Notes to the consolidated financial statements (Continued)
December 31, 2012

17—Borrowings and other financial liabilities (Continued)

17.4 Maturity of financial liabilities

	December 31, 2012	< 1 year	Between 1 and 5 years	> 5 years
		(in millions of euros)		
Bonds	1 133,9	25,4	77,3	1 031,2
Related party bonds	109,0	—	—	109,0
Bank credit facilities	343,7	86,5	27,5	229,7
Finance leases	8,8	1,4	3,4	4,0
Accrued interest	3,0	3,0	—	—
Bank overdraft	—	—	—	—
Other financial liabilities	111,0	—	7,8	103,2
Financial instruments	62,5	—	—	62,5
Nominal value of borrowings	1 771,9	116,3	116,0	1 539,6

	December 31, 2011	< 1 year	Between 1 and 5 years	> 5 years
		(in millions of euros)		
Bonds	303,8	12,4	102,0	189,3
Related party bonds	73,9	—	—	73,9
Bank credit facilities	764,9	228,3	161,5	376,6
Finance leases	8,4	1,1	1,3	4,4
Accrued interest	2,2	2,2	—	—
Bank overdraft	—	—	—	—
Other financial liabilities	86,0	0,7	2,8	82,5
Financial instruments	—	—	—	—
Nominal value of borrowings	1 239,2	244,7	267,6	726,7

17.5 Currency of borrowings

	December 31, 2012	Euro (EUR)	US Dollar (USD)	Israeli Shekel	Swiss Franc
		(in millions of euros)			
Bonds	1 133,9	—	839,3	294,6	—
Related party bonds	109	109	—	—	—
Bank credit facilities	343,7	319,7	—	—	24
Finance leases	8,8	6,2	—	—	2,6
Accrued interest	3	1,2	1,6	—	0,2
Bank overdraft	—	—	—	—	—
Other financial liabilities	111	108,1	—	2,7	0,2
Financial instruments	62,5	—	62,5	—	—
TOTAL	1 771,9	544,2	903,4	297,3	27

ALTICE VII S.À R.L.
Notes to the consolidated financial statements (Continued)
December 31, 2012

17—Borrowings and other financial liabilities (Continued)

	December 31, 2011	Euro (EUR)	US Dollar (USD)	Israeli Shekel	Swiss Franc
		(in millions of euros)			
Bonds	303,8	—	—	303,7	—
Related party bonds	73,9	73,9	—	—	—
Bank credit facilities	764,9	292,6	—	450,9	21,4
Finance leases	8,4	6,5	—	—	1,9
Accrued interest	2,2	2,2	—	0,1	—
Bank overdraft	—	—	—	—	—
Other financial liabilities	86	82,4	—	3,1	0,5
Financial instruments	—	—	—	—	—
TOTAL	1 239,2	457,6	—	757,8	23,8

17.6 Nature of interest rate

	December 31, 2012	Fixed interest rate	Floating interest rate
	(in millions of euros)		
Bonds	1 133,9	969,7	164,2
Related party bonds	109	109	—
Bank credit facilities	343,7	229,9	113,8
Finance leases	8,8	2,6	6,2
Accrued interest	3	3	—
Bank overdraft	—	—	—
Other financial liabilities	111	108,1	2,9
Financial instruments	62,5	62,5	—
TOTAL	1 771,9	1 484,8	287,1

	December 31, 2011	Fixed interest rate	Floating interest rate
	(in millions of euros)		
Bonds	303,8	—	303,8
Related party bonds	73,9	73,9	—
Bank credit facilities	764,9	245,2	519,7
Finance leases	8,4	1,9	6,5
Accrued interest	2,2	0,1	2,2
Other financial liabilities	86	83,5	2,5
TOTAL	1 239,2	404,5	834,6

17.7 Coditel Holding swaps

As of December 31, 2012, off balance sheet commitments include:

The shares, bank accounts and receivables of Coditel Brabant S.p.r.l. and Coditel S.à r.l. have been pledged. Coditel Holding is not allowed to pledge these assets as security for other borrowings or to sell them to another entity.

On February 2012, Coditel Holding has concluded the following swap transactions:

- a swap transaction with ING amounting to EUR 35 million with a maturity date on March 31, 2015 and an interest rate composed of a fixed rate of 0,770% and an EUR-euribor-reuters floating rate;

ALTICE VII S.À R.L.
Notes to the consolidated financial statements (Continued)
December 31, 2012

17—Borrowings and other financial liabilities (Continued)

- a swap transaction with ING amounting to EUR 17,5 million with a maturity date on March 31, 2015 a fixed rate of 0,775% and an EUR-euribor-reuters floating rate;
- a swap transaction with ING amounting to EUR 50 million with a maturity date on March 31, 2015 a fixed rate of 0,710% and an EUR-euribor-reuters floating rate;
- a swap transaction with KBC amounting to EUR 20 million with a maturity date on March 31, 2015 a fixed rate of 0,755% and an EUR-euribor-reuters floating rate;
- a swap transaction with HSBC amounting to EUR 17 million with a maturity date on March 31, 2015 a fixed rate of 0,770% and an EUR-euribor-reuters floating rate.

18—Financial risk factors

In the course of its business, the Group is exposed to a number of financial risks: credit risk, liquidity risk, market risk (including foreign currency risk and interest rate risk), commodity price risk and other risks (including equity price risk and settlement risk). This note presents the Group's objectives, policies and processes for managing its financial risk and capital.

Financial risk management is an integral part of the way the Group is managed. The Board of Managers establishes the Group's financial policies and the Chief Executive Officer establishes objectives in line with these policies.

The Group is not subject to any externally imposed capital requirements.

18.1 Credit risk

The Group does not have significant concentrations of credit risk. The credit risk may arise from the exposures of commitments under a number of financial instruments with one body or as the result of commitments with a number of Groups of debtors with similar economic characteristics, whose ability to meet their commitments could be similarly affected by economic or other changes.

Qualities that could cause a concentration of risk include the significance of the activities that the debtors are involved in, such as the branch in which the geographical region in which they conduct their activities and the level of their financial stability.

The Group's income mainly derives from customers in Israel, in the French Overseas Territories and in Europe (Belgium, Luxembourg, Portugal and Switzerland). The Group regularly monitors its customers' debts and provisions for doubtful debts are recorded in the financial statements, which provide a fair value of the loss that is inherent to debts whose collection lies in doubt.

The Group does not have significant concentration of credit risk, as a result of the Group's policy, which ensures that the sales are mostly made under standing orders or via credit cards.

18.2 Liquidity risk

Ultimate responsibility for liquidity risk management rests with management, which have established an appropriate liquidity risk management framework for the management of the short, medium and long-term funding and liquidity management requirements of the Group. The Group manages liquidity risk by maintaining adequate reserves, banking facilities and reserves borrowing facilities, by continuously monitoring forecast and actual cash flows, and by matching the maturity profiles of financial assets and liabilities.

18.3 Market risks

The Group is exposed to risk from movements in foreign currency exchange rates, interest rates and market prices that affect its assets, liabilities and anticipated future transactions.

ALTICE VII S.À R.L.
Notes to the consolidated financial statements (Continued)
December 31, 2012

18—Financial risk factors (Continued)

18.3.1 Interest rate risk

Interest rate risk comprises the interest price risk that results from borrowings at fixed rates and the interest cash flow risk that results from borrowings at variable rates.

The Group has an exposure to risk in respect of changes in the interest rate in the market, deriving from long-term loans that have been received and which bear variable rate interest.

Interest structure of non-current financial debt (including interest effects of derivatives):

	December 31, 2012	December 31, 2011
	(in millions of euros)	
Financial debt at fixed rates	1 484,8	404,6
Financial debt at variable rates	287,1	834,6
TOTAL	<u>1,771,9</u>	<u>1,239,2</u>

18.3.2 Israeli CPI risk

The Group has borrowed from banks and issued debentures that are linked to the changes in the Israeli CPI. Also, the Group has deposits and gave loans that are linked to the changes in the Israeli CPI. The net amount of the financial instruments that are linked to the Israeli CPI and for which the Group is exposed to changes in the Israeli CPI amounted to approximately EUR 247 million as of December 31, 2012.

18.3.3 Foreign currency risk

The Group is exposed to foreign currency risk from transactions and translation. Transactional exposures are managed within a prudent and systematic hedging policy in accordance with the Group's specific business needs. Translation exposure arises from the consolidation of the financial statements of foreign operations in euros, which is, in principle, not hedged. The Group's objective is to manage its foreign currency exposure through the use of currency forwards, futures, swaps and options.

	December 31, 2012		
	Israeli Shekel	Swiss Franc	Total
	(in millions of euros)		
Profit for the year			
Increase of 10% in exchange rate	(12,9)	(0,1)	(13,1)
Decrease of 10% in exchange rate	12,9	0,1	13,1
Equity			
Increase of 10% in exchange rate	23,3	3,0	26,3
Decrease of 10% in exchange rate	(23,3)	(3,0)	(26,3)
	December 31, 2011		
	Israeli Shekel	Swiss Franc	Total
	(in millions of euros)		
Profit for the year			
Increase of 10% in exchange rate	(10,7)	(0,1)	(10,9)
Decrease of 10% in exchange rate	10,7	0,1	10,9
Equity			
Increase of 10% in exchange rate	(1,3)	(2,1)	(3,4)
Decrease of 10% in exchange rate	1,3	2,1	3,4

ALTICE VII S.À R.L.
Notes to the consolidated financial statements (Continued)
December 31, 2012

18—Financial risk factors (Continued)

Exchange differences recorded in the income statement represented a loss of EUR 22,5 million in 2012 (2011: loss of EUR 14,0 million). They are allocated to the appropriate headings of expenses by nature.

The Group estimates that a 10% variation of foreign currencies against euro parity is a relevant change of variables and reasonably possible risk in a year and the presented above allows to assess the impact of a 10% increase of foreign currencies against euro on net result and reserves. A 10% decrease would have a symmetrical impact with the same amounts but in the opposite direction.

18.3.4 Price risk

The Group has investments in listed financial instruments, shares and debentures that are classified as available-for-sale financial assets and financial assets at fair value through profit or loss in respect of which the Group is exposed to risk of fluctuations in the security price that is determined by reference to the quoted market price. As of December 31, 2012, the carrying amount of these investments was EUR 5,7 million.

18.4 Sensitivity tests in respect of a change in market factors

The sensitivity analysis in respect of financial instruments was performed under the assumption that the amount that was in force as of the statement of financial position date was in force throughout the reporting period.

The changes that have been selected as variables for the relevant risk were determined in accordance with management's assessment in respect of the possible reasonable changes in those risk variables.

18.5 Gearing computation

Gearing ratio (net debt (1) /total equity holders' equity (2)) amounts, respectively in 2012 and 2011, to 5,4 and 1,6.

<u>Consolidated Statement of financial position</u>	<u>December 31, 2012</u>	<u>December 31, 2011</u>
	(in millions of euros)	
Total assets in balance sheet	2,720,0	2,503,7
Cash and cash equivalents	(129,7)	(19,8)
Trade payables	(311,3)	(208,2)
Other payables	(108,1)	(98,4)
Other non-current liabilities	(49,5)	(46,1)
Deferred tax liabilities	(148,2)	(123,7)
Current tax liabilities	(10,7)	(7,2)
Net assets in balance sheet	1,962,6	2,000,4
Net Debt (short term and long term)	1 514,1	1 143,9
Issued capital	7,4	7,4
Other reserves	—	232,9
Retained earnings	277,5	25,8
Retained earnings/(accumulated losses)	138,0	118,4
Equity attributable to equity holders of the parent	(148,9)	384,5
Non-controlling interests	5,2	349,2
Total equity	285,7	733,6
Total equity and liabilities	1,795,2	1,871,2
Gearing	5,4	1,6

(1) Excluding loan from related parties

ALTICE VII S.À R.L.
Notes to the consolidated financial statements (Continued)
December 31, 2012

18—Financial risk factors (Continued)

18.6 Fair value of financial assets and liabilities

18.6.1 Fair value of financial instruments carried at amortized cost

The managers consider that the carrying amounts of financial assets and financial liabilities recognized in the consolidated financial statements and accounted for at their amortized cost approximate their fair value.

18.6.2 Valuation techniques and assumptions applied for the purposes of measuring fair value

The fair value of financial assets and financial liabilities are determined as follow:

The fair values of financial assets and financial liabilities with standard terms and conditions and traded an active liquid markets are determined with reference to quoted market prices (includes listed redeemable notes, bills of exchange, debentures and perpetual notes);

The fair value of derivatives instruments are calculated using quote prices. Where such prices are not available, a discounted cash flow analysis is performed using the applicable yield curve for the duration of the instruments for non-optional derivatives, and option pricing models for optional derivatives. Foreign currency forward contracts are measured using quoted forward exchange rates and yield curves derived from quoted interest rates matching maturities of the contracts. Interest rate swaps are measured at the present value of future cash flows estimated and discounted based on the applicable yield curves derived from quoted interest rates; and

The fair value of other financial assets and financial liabilities (excluding those described above) are determined in accordance with generally accepted pricing models based on discounted cash flow analysis.

Specially, significant assumptions used in determining the fair value of the following financial assets and liabilities are set out below.

19—Trade and other payables

	December 31, 2012	December 31, 2011
	(in millions of euros)	
Trade payable	311,3	208,2
Trade payables—acquisition of assets	2,9	3,5
Corporate and social security contributions	24,5	26,2
Corporate income tax payable	10,7	7,2
Deferred revenue	34,1	31,3
Other payables	46,3	37,4
Liabilities from related parties	0,2	—
Total	<u>430,1</u>	<u>313,8</u>

A part of the trade payable increase as of December 31, 2012 results from the Cabovisao business combination. The rest is explained by the increase in business of other subsidiaries of the Group.

ALTICE VII S.À R.L.
Notes to the consolidated financial statements (Continued)
December 31, 2012

20—Other non current liabilities

	December 31, 2012	December 31, 2011
	(in millions of euros)	
Trade payables—acquisition of assets	5,9	—
Deferred revenue	10,8	9,4
Other payables	32,9	36,7
Total	49,5	46,1

21—Classification and fair value of financial assets and liabilities

	December 31, 2012					
	Book value	Amortized cost	Fair Value			
			Fair value through profit/loss	Assets available for sale	Loans & Receivables	Derivative instruments
			(in millions of euros)			
Current assets						
Cash and cash equivalents	129,7	129,7	—	—	—	—
Trade receivables	150,8	150,8	—	—	—	—
Other receivables	37,9	37,9	—	—	—	—
Non-current assets						
Restricted cash	9,6	9,6	—	—	—	—
Investments in financial assets available for sale	—	—	—	—	—	—
Available for Sale	5,7	—	—	5,7	—	—
Long term trade receivables	2,7	2,7	—	—	—	—
Other long-term trade receivables	40,9	24,6	—	—	16,3	—
	377,4	355,3	—	5,7	16,3	—
Current liabilities						
Credit from banking corporations and debentures	113,2	113,2	—	—	—	—
Trade payables	311,3	311,3	—	—	—	—
Others payables	118,8	118,8	—	—	—	—
Short-term loans from related parties	2,7	2,730,0	—	—	—	—
Non-current liabilities						
Loans from banking corporations and debentures	1 373,2	1 373,2	—	—	—	—
Long-term loans from related parties	170,8	170,8	—	—	—	—
Other financial liabilities	111,9	49,5	—	—	62,5	—
Other non-current liabilities	49,5	49,5	—	—	—	—
	2 251,4	2 189	—	—	62,5	—

ALTICE VII S.À R.L.
Notes to the consolidated financial statements (Continued)
December 31, 2012

21—Classification and fair value of financial assets and liabilities (Continued)

On December 31, 2012 and 2011, the principles for measuring financial instruments and their market value breaks down as follows:

	December 31, 2011				
	Book value	Amortised cost	Fair value		
			Fair value through profit/loss	Assets available for sale	Derivative instruments
	(in millions of euros)				
Current assets					
Cash and cash equivalents	19,8	19,8	—	—	—
Trade receivables	102,7	102,7	—	—	—
Other receivables	17,2	17,2	—	—	—
Non-current assets					
Restricted cash	41,4	41,4	—	—	—
Investments in financial assets available for sale	—	—	—	—	—
Available for Sale	8,5	—	—	8,5	—
Long term trade receivables	2,4	2,4	—	—	—
Other long-term trade receivables	28,4	24,2	—	—	4,3
	220,3	207,5	—	8,5	4,3
Current liabilities					
Credit from banking corporations and debentures	241,8	241,8	—	—	—
Trade payables	208,2	208,2	—	—	—
Others payables	98,4	98,4	—	—	—
Short-term loans from related parties	2,9	2,9	—	—	—
Non-current liabilities					
Loans from banking corporations and debentures	835,2	835,2	—	—	—
Long-term loans from related parties	127,1	127,1	—	—	—
Other financial liabilities	32,1	28,3	3,8	—	—
Other non-current liabilities	46,1	46,1	—	—	—
	1 591,8	1 588	3,8	—	—

The classification of financial instruments in accordance with hierarchical levels for fair values:

The financial instruments that are presented in the consolidated statement of financial position in accordance with their fair value are classified into hierarchical levels for fair values, as aforesaid, which are determined in accordance with the source of the input that was used for determining the fair value:

- Level 1—Quoted prices (without adjustments) in an active market for identical assets and liabilities.
- Level 2—Inputs other than quoted prices that are included in level 1, which can be observed directly or indirectly.
- Level 3—Inputs that are not based on observable market data (an evaluation technique that does not use observable market data).

ALTICE VII S.À R.L.
Notes to the consolidated financial statements (Continued)
December 31, 2012

21—Classification and fair value of financial assets and liabilities (Continued)

As result, as of December 31, 2012, classification of financial instruments are as follows:

	December 31, 2012			
	Level 1	Level 2	Level 3	Total
	(in millions of euros)			
Financial liabilities at FVTPL				
Other derivatives financial liabilities	—	62,5	—	62,5
AFS				
AFS HOT Telecom (Level 1)	5,7	—	—	5,7
	<u>5,7</u>	<u>62,5</u>	<u>—</u>	<u>68,2</u>

The notional principal amounts of the outstanding forward foreign exchange contracts at December 31, 2012 as follows:

- FX Forward contract: USD 550 million, the maturity date will be on December 15, 2017 and swap to NIS at the aggregate rate of 4,1700, this contract relates to a hedge of the notional of the debt and also the rate accretes up to 4,17 in December 15, 2017;
- FX Forward contract: USD 98,9 million, the maturity date is based on the interest date payment from June 17, 2013 to December 15, 2017 and swap to NIS at the aggregate rate of each interest payment period, this contract is related to interest rate hedging, exchanging fixed Euro and USD interest payments into fixed NIS payments.
- FX Forward contract: EUR 40,1 million, the maturity date is based on the interest date payment from June 17, 2013 to December 15, 2017 and swap to NIS at the aggregate rate of each interest payment period, this contract is related to interest rate hedging, exchanging fixed Euro and USD interest payments into fixed NIS payments.

The notional principal amounts of the outstanding forward foreign exchange contracts at December 31, 2012 as follows:

- Cross currency swap: USD 200 million, the maturity date will be on December 15, 2017 swap NIS at the aggregate rate of 7,7550%,
- Cross currency swap: USD 225 million, the maturity date will be on December 15, 2017 swap NIS at the aggregate rate of 5,6850%,
- Cross currency swap: EUR 100 million, the maturity date will be on December 15, 2017 swap NIS at the aggregate rate of 5,7750%.

Those contracts are effectively fixed Euro and USD interest payments in NIS.

ALTICE VII S.À R.L.
Notes to the consolidated financial statements (Continued)
December 31, 2012

21—Classification and fair value of financial assets and liabilities (Continued)

As of December 31, 2011, classification of financial instruments' issue mainly concerns HOT Telecom perimeter:

<u>HOT Telecom</u>	<u>As of December 31, 2011</u>		
	<u>Level 1</u>	<u>Level 2</u>	<u>Level 3</u>
	(in millions of euros)		
Available for sale financial asset:			
Shares	8,5		—
Financial assets at fair value through profit or loss:			
Forward contracts in foreign currency that are not defined as accounting hedges		5,1	
Financial liabilities at fair value through profit or loss:			
Embedded derivatives		(0,4)	
Interest rate swap contract		(0,2)	
Liability to the Ministry of Communications			(3,8)

22—Taxes on income

22.1 Income tax (expense)/benefit

	<u>December 31, 2012</u>	<u>December 31, 2011</u>
	(in millions of euros)	
Current income tax	4,2	0,2
Carry back	—	(0,2)
Deferred taxes on deductible temporary differences	21,7	(32,4)
TOTAL	<u>26,0</u>	<u>(32,5)</u>

22.2 Deferred tax assets and liabilities

	<u>December 31, 2011</u>	<u>Business combination</u>	<u>From equity</u>	<u>From profit and loss</u>	<u>December 31, 2012</u>
	(in millions of euros)				
Other	0,2	—	—	0,2	0,4
IAS 16, Property, Plant and Equipment	0,1	—	—	0,3	0,4
IAS 36, Depreciable fixed assets	—	—	(0,6)	—	(0,6)
IAS 38, Intangible assets . . .	—	—	—	—	—
IAS 39, Financial Instruments	—	—	—	19,0	19,0
Total deferred taxes assets	<u>0,3</u>	<u>—</u>	<u>(0,6)</u>	<u>19,5</u>	<u>19,3</u>

ALTICE VII S.À R.L.
Notes to the consolidated financial statements (Continued)
December 31, 2012

22—Taxes on income (Continued)

	December 31, 2011	Business combination	From equity	From profit and loss	December 31, 2012
	(in millions of euros)				
Customer relationships	52,0	3,6	—	(2,8)	51,3
Brand	9,3	7,4	—	—	16,7
Other Intangible assets	23,9	—	(4,7)	2,1	21,3
Reevaluation of Tangible assets	11,0	23,2	—	(4,1)	30,1
IAS 23, Borrowing Costs	3,6	—	—	(0,4)	3,1
IAS 36, Depreciable fixed assets	(11,1)	—	(1,4)	3,6	(8,8)
Present value of YFPECS financial instrument	9,0	—	—	0,2	9,3
Temporary differences	22,8	—	—	(0,5)	22,3
Other	3,1	—	0,1	(0,1)	3,1
Total deferred taxes liabilities	123,7	32,7	(6,0)	(2,0)	148,4

	December 31, 2010	Business combination	From equity	From profit and loss	December 31, 2011
	(in millions of euros)				
Other	—	—	—	0,2	0,2
IAS 16, Property, Plant and Equipment	—	—	—	0,1	0,1
IAS 38, Intangible assets	—	—	—	—	—
Total deferred taxes assets	—	—	—	0,3	0,3

	December 31, 2010	Business combination	From equity	From profit and loss	December 31, 2011
	(in millions of euros)				
Customer relationships	6,9	44,0	(1,1)	2,3	52,0
Brand	3,1	6,0	0,1	0,1	9,3
Other Intangible assets	—	10,3	(0,3)	13,9	23,9
Revaluation of Tangible assets	1,0	10,6	(0,4)	(0,3)	11,0
IAS 23, Borrowing Costs	—	—	—	3,6	3,6
IAS 36, Depreciable fixed assets	—	1,5	(0,1)	(12,6)	(11,1)
Present value of YFPECS financial instrument	9,2	—	—	(0,2)	9,0
Temporary differences	6,5	—	(6,4)	22,8	22,8
Other	(0,4)	—	0,5	2,9	3,1
Total deferred taxes liabilities	26,3	72,4	(7,6)	32,6	123,7

ALTICE VII S.À R.L.
Notes to the consolidated financial statements (Continued)
December 31, 2012

22—Taxes on income (Continued)

22.3 Reconciliation between the effective tax rate and the theoretical tax rate

	December 31, 2012	December 31, 2011
	(in millions of euros)	
Net income	(189,8)	123,9
Share of net income—associates	—	(11,7)
Share of net income—equity holders	(189,8)	112,3
Tax charge [(–) expenses/(+) income]	(26,0)	32,5
Earnings/(Loss) before tax	(215,8)	156,6
Theoretical tax rate	28,80%	28,80%
Income tax calculated on theoretical tax	62,1	(45,0)
Impact of:		
Effect of different tax rates of subsidiaries depending in other jurisdictions	(5,8)	
Permanent differences	(57,0)	7,9
Restatements without tax impact	18,7	10,6
Utilization of previously non capitalized tax credit	20,0	3,6
Carry-back	0,1	(0,2)
Tax loss carry forwards of the periods non activated	(13,2)	(9,7)
Effect of unused tax losses not recognized as Deferred tax asset	1,0	0,3
Effective Tax	25,9	(32,5)
Effective tax rate		27,66%

Permanent differences stated above are almost exclusively present at the Cool Holdings sub consolidated level. Permanent differences totaled EUR 50,4 million and were comprised of EUR 30,0 million arising from the adjustment on the Goodwill at Cool Holdings Limited and another EUR 20,4 million related to finance costs at Cool Holdings Limited.

22.4 Tax assessments

22.4.1 Hot Telecom

In December 2009 and in the course of the year 2010, HOT received tax assessments for the 2006-2008 tax years, in accordance with section 145(A)(2)(b) of the Income Tax Ordinance. In accordance with the tax assessments, expenses amounting to approximately EUR 220 million were adjusted for HOT for tax purposes as of the end of the year 2008, and this was as a result of a disagreement between HOT and the Tax Authority in Israel, primarily in respect of the pace of the recognition of depreciation expenses in respect of the cables network and additional issues. If the said position of the Tax Authority in relation to the assessments that were issued to HOT in respect of the 2006, 2007 and 2008 tax years is received, HOT will be exposed to a demand for the payment of tax in a cumulative amount of EUR 24 million. Linkage differentials and interest will be added to this amount. Furthermore, HOT will be exposed to a demand for the payment of additional taxation in significantly larger amounts in respect of the tax years after 2008.

HOT's management, on the basis of its position in the self-assessments and based upon its legal advice, has presented an objection against the tax assessments for the years 2006 - 2008 and in the opinion of HOT's management and its professional advisers, HOT has well founded complaints against the claims made in the tax assessments for the years 2006 - 2008, which could significantly change the results of the tax assessments for those years and could also significantly change the implications deriving from them in respect of the tax years after 2008.

ALTICE VII S.À R.L.
Notes to the consolidated financial statements (Continued)
December 31, 2012

22—Taxes on income (Continued)

At the present time, discussions are being held on the assessments, within the framework of Stage B for the years 2006 - 2008 and within the framework of Stage A for the 2009 - 2010 tax years. A number of issues have come within the framework of the discussions including the manner of the depreciation of the cables network infrastructure and the manner of the amortization of the intangible assets—brand, goodwill and customer connections. Up to the time of the publication of the financial statements, no assessment has yet been issued in respect of the aforesaid.

A provision of EUR 2 million has been recorded within the framework of the financial statements in respect of HOT estimated exposure in respect of the dispute with the tax authorities in respect of open tax years.

HOT has been issued with final tax assessments up to and including the 2005 tax year. The consolidated companies HOT Vision, HOT Haifa and HOT Eidan have been issued with final tax assessments up to and including the 2001 tax year. The consolidated companies HOT Edom and HOT Net (formerly HOT Investments and Finance) have been issued with final tax assessments up to and including the 2002 tax year. The consolidated company HOT T.L.M. has been issued with final tax assessments up to and including the 2004 tax year. The consolidated companies Drom Hasharon and HOT Properties have been issued with final tax assessments up to and including the 2008 tax year.

The consolidated companies HOT T.L.M., HOT Eidan and HOT Haifa have tax assessments that are considered to be final up to and including the 2005 tax year. The consolidated company HOT Mobile have tax assessments that are considered to be final up to and including the 2008 tax year. The consolidated companies HOT Vision, HOT Edom and Hot Net (formerly HOT Investments and Finance) have tax assessments that are considered to be final up to and including the 2007 tax year. The said assessments are considered to be final subject to the powers that have been afforded to the Director of the Tax Authority in Israel in accordance with section 145, 147 and 152 of the Income Tax Ordinance.

22.4.2 Cabovisao

Cabovisao is subject to corporate income tax at the rate of 25%, increased by a municipal surcharge at the applicable rate up to 1.5%, resulting in an aggregate rate of a maximum of 26.5%. Additionally, any taxable profit in excess of EUR 1,5 million is subject to a State surcharge of 3%, being 5% if the taxable net, or exceeds EUR 10 million, according to article 87-A of the corporate income tax law.

In accordance with the article 88 of the corporate income tax law, Cabovisao is subject to autonomous taxation over some costs incurred by Cabovisao at the rates provided for in the above-mentioned article.

In accordance with current legislation, tax returns are subject to review and correction by the tax authorities during a four-year period or, if tax losses are carried forward or a deduction or tax credit used, for the period for which such right is exercised (five years for Social Security). These periods can be suspended when there are tax inspections, claims or appeals in progress. Consequently, Cabovisao's tax returns for the years 2009 to 2012 are subject to review by the tax authorities.

Cabovisao was subject to an inspection from the Portuguese tax authorities for the fiscal years 2003 to 2006, and the outcome was the following:

Notification for fiscal year 2003 to adjust tax losses by EUR 7,2 million and an additional payment of stamp taxes for fiscal years 2000 to 2002 in the amount of EUR 1,3 million. The Company did not agree with the additional payment of stamp taxes, having claimed through a lawsuit appeal against the Portuguese Tax Authorities, presenting a bank guarantee in the amount of EUR 1,7 million. During the year ended August 31, 2011, the Almada Administrative and Fiscal Court decided the appeal was unfounded. Cabovisao has appealed against that decision before the Almada Administrative and Fiscal Court.

Assessment of the Portuguese Tax Authorities related to 2005, requests an adjustment to tax losses in the amount of EUR 17,1 million, as well as an additional tax payment in the amount of EUR 4 million, for

ALTICE VII S.À R.L.
Notes to the consolidated financial statements (Continued)
December 31, 2012

22—Taxes on income (Continued)

withholding tax and stamp tax. Cabovisao paid EUR 2,6 million and contested this decision of the assessment through a gracious complaint and hierarchical appeal, but has not received the final decision yet. The unpaid amount of, approximately, EUR 1 million, was contested by hierarchic appeal. In the year ended 31 August, 2012, the Corporate Tax accepted the claim. As of the date of this report, there were not any subsequent deliberations after that decision.

For 2006, an assessment of tax payable on withholding tax linked to interest due to CSII in the amount of approximately EUR 4,9 million. Cabovisao doesn't agree with this assessment, having filed a gracious complaint and submitted a bank guarantee in the amount of approximately EUR 6,8 million. As of December 31, 2012, the administrative and tax court of Almada didn't pronounce on that claim, therefore it wasn't taken any subsequent deliberations.

The Board of Managers believes that any adjustments resulting from tax revisions to the tax returns of these exercises, taking into account the provisions recorded will not have a significant effect on the financial statements on December 31, 2012.

22.5 Unrecognized deferred tax assets

As at December 31, 2012, unrecognized deferred tax assets amount to EUR 33,4 million and split as follows:

- Cool Holding: EUR 21,2 million,
- Coditel Holding Lux S.à r.l.: EUR 13,63 million,
- Cabovisao: EUR 51,3 million.

23—Segment analysis

23.1 Definitions of segments

Given the geographic spread of the various Group entities, it logically follows that an analysis and control by geography is inalienable to Group strategy of managing its different businesses. It has thus been decided by the central management team to analyse the business across geographies and then by activity. The following geographies have been identified:

Israel,

Belgium and Luxembourg (Western Europe),

Portugal (Western Europe),

French Overseas Territories (Antilles and Indian Ocean),

Other (Switzerland, Africa etc.).

Activities have been split as follows:

Cable,

Mobile,

Others (B2B/Content/etc.).

23.1.1 Operational KPIs

It has also been decided by the central team that local operational teams in each geography shall report operational KPIs every week and operational and financial KPIs every month using a standard reporting format defined by the central team.

ALTICE VII S.À R.L.
Notes to the consolidated financial statements (Continued)
December 31, 2012

23—Segment analysis (Continued)

The main operational KPIs that will be tracked will be:

- Subscriber base evolution (both cable and mobile),
- ARPU (Average Revenue per Unit) (cable and mobile),
- Other relevant cost drivers.

These KPIs are benchmark indicators followed throughout the industry and allow for a thorough and accurate analysis of the business and strategic decision making.

23.1.2 Financial KPIs

Each local operational company will also report the following financial KPIs by segment:

- Revenues (Cable/Mobile/Other),
- Cost of Sales (Cable/Mobile/Other),
- Capex (Cable/Mobile/Other).

The central team believes that given the uniformity in the accounting and nature of operating expenses and given the experience and competence of the Group in managing operating costs, the main indicator that can vary between business units is the gross margin.

HOT Telecom however will report EBITDA on cable and mobile, in addition to the KPIs mentioned above. This derives from the size of the mobile business and the fact that historically, this business had separate reporting for these two activities and also because local regulation require operators to report the EBITDA on these segments.

Capital expenditure (Capex) is an important indicator to follow, as the profile varies greatly between the two activities:

The cable business has small fixed Capex requirements and initial Capex is quite low, but variable Capex is high, as an increase in customers drives the cash needs for Customer Premise Equipment (CPE) and installation.

Mobile Capex is one-off and mainly driven by investment in new mobile sites and licences to operate. Once the Capex is engaged and the business operational, there is limited Capex requirement.

Thus, the central team places a great emphasis on the proper tracking of capital expenditures and reviewing them against the costs budgeted for the year.

Management believes that operations in Switzerland and activities such as B2B sales are not yet substantial enough to warrant a separate reporting segment and will be reported under 'Others'. However, as these activities grow, it is intended that they are also reported under a separate segment with relevant operating KPIs specific to the activity. Financial KPIs are expected to remain the same. The same applies to any new line(s) of business that the Group may decide to venture into (for e.g., content etc.).

23.2 Regional specificities

23.2.1 Israel

Israel is currently an important contributor to the Group revenues and EBITDA and, for this reason, is classified as a separate region. Apart from this, this region has particularities that differentiate it.

It is characterised by a high broadband and cable penetration and the general population is very technology focussed. The market is maturing but highly regulated, which means that while opportunities

ALTICE VII S.À R.L.
Notes to the consolidated financial statements (Continued)
December 31, 2012

23—Segment analysis (Continued)

for growth exist, they may be limited by specific regulatory challenges and also by high competition, thus leading to price pressures on ARPU development.

Triple play penetration is low and this represents the biggest development path. Customer retention is difficult as contractual terms heavily favour the customer and, hence, price increases, even when coupled with high value content, can be negatively perceived and lead to an erosion of the customer base.

The regulatory environment does not yet allow for quadruple play packages, which heavily restricts achieving full integration and operational synergies with the mobile business. The prevailing political environment in the region can also have adverse impacts on the development of the business, as a deterioration of the situation may have serious repercussions on the market environment and may even lead to physical damage of the infrastructure.

23.2.2 Belgium and Luxembourg

Even though Belgium/Luxembourg and Portugal can be considered to be the same sub-region, the challenges posed by these two regions are quite distinctly different.

The Belgian and Luxembourg territories have a high standard of living and well developed economies, which translates into higher prices for services. The markets are quite mature, with high broadband penetration and a high percentage of triple play customers. Customers are willing to pay more for premium services (high ARPU/subs) and hence price pressures are low.

These regions are marked by the presence of many well established cable operators and customer retention is a key factor in maintain strong profit margins.

Given the density and presence of mobile operators, the mobile strategy is driven by MVN operations, which allows the presence of quadruple play packages.

23.2.3 Portugal

The Portuguese market is marked by a high concentration of double play subscribers and a mature telecommunications market, which, when coupled with slow economic recovery after the crisis, makes it difficult to achieve high sales growth. This market is marked by high subscriber attrition and downward migration from high to low ARPU offers.

The challenge in Portugal is to maintain a subscriber base and then slowly migrating the customer base from double play to triple play offers.

23.2.4 French Overseas Territories

The French Overseas Territories represent an attractive market with high scope of growth in cable operations, owing to relatively limited competition and relatively low cable penetration. There is also a large scope for synergies between the cable and mobile businesses, as triple play penetration remains low and regulatory flexibility allows the marketing of quadruple play options.

Price pressures are low in these markets and customers are willing to pay more for value added services. Double play (TV and Internet) offers are predominant in these regions and the migration of new and existing customers to triple and quadruple play packages in the future will be an important factor in growing sales.

There are other opportunities for growth in the sector, most notably in the e-banking sector.

ALTICE VII S.À R.L.
Notes to the consolidated financial statements (Continued)
December 31, 2012

23—Segment analysis (Continued)

23.3 Segment information

Details regarding revenues, cost of sales and gross profit for our cable, mobile and other segments are as follows:

	December 31, 2012					
	Total	Belgium & Luxembourg	Israel	French Overseas Territories	Portugal	Others
	(in millions of euros)					
Cable						
Revenue	873,3	70,3	677,9	24,4	98,2	2,5
Costs of sales	(212,9)	(10,3)	(159,0)	(4,1)	(39,1)	(0,5)
Gross Profit	660,4	60,0	518,9	20,4	59,1	2,0
Mobile						
Revenue	172,7	0,2	172,5	—	—	—
Costs of sales	(69,9)	(0,1)	(69,8)	—	—	—
Gross Profit	102,8	0,1	102,7	—	—	—
Other						
Revenue	46,4	0,8	—	—	—	45,6
Costs of sales	(19,3)	(0,6)	—	—	—	(18,7)
Gross Profit	27,1	0,2	—	—	—	26,9
Total						
Total Revenue	1,092,4	71,3	850,4	24,4	98,2	48,1
Total Costs of sales	(302,1)	(11,0)	(228,8)	(4,1)	(39,1)	(19,2)
Total Gross Profit	790,3	60,3	621,7	20,4	59,1	28,9

	December 31, 2011					
	Total	Belgium & Luxembourg	Israel	French Overseas Territories	Portugal	Others
	(in millions of euros)					
Cable						
Revenue	560,3	34,5	499,7	23,6	—	2,5
Costs of sales	(125,3)	(6,9)	(114,1)	(3,8)	—	(0,5)
Gross Profit	435,0	27,6	385,6	19,8	—	1,9
Mobile						
Revenue	180,6	—	180,6	—	—	—
Costs of sales	(31,0)	—	(31,0)	—	—	—
Gross Profit	149,7	—	149,7	—	—	—
Other						
Revenue	43,3	0,4	—	—	—	42,9
Costs of sales	(19,1)	(0,5)	—	—	—	(18,7)
Gross Profit	24,1	(0,1)	—	—	—	24,2
Total						
Total Revenue	784,2	34,8	680,4	23,6	—	45,4
Total Costs of sales	(175,4)	(7,3)	(145,1)	(3,8)	—	(19,2)
Total Gross Profit	608,8	27,5	535,3	19,8	—	26,2

ALTICE VII S.À R.L.
Notes to the consolidated financial statements (Continued)
December 31, 2012

24—Operating expenses

	December 31, 2012	December 31, 2011
	(in millions of euros)	
Technical and maintenance costs	(228,2)	(185,0)
Customer services	(18,3)	(9,9)
Taxes	(2,4)	(0,5)
Total	<u>(248,9)</u>	<u>(195,4)</u>

The increase in operating expenses was mainly related to the acquisition of Cabovisao, a Portuguese cable operator in February 2012 and the full year impact of the consolidation of HOT's cable business in 2012 (full 12 months vs. 9 months in 2011).

25—Equity based compensation

Equity based compensations are included in the line item "General & administrative expenses" in these consolidated financial statements and amounted to EUR 3,8 million.

26—Other operating incomes and expenses

	December 31, 2012	December 31, 2011
	(in millions of euros)	
Other incomes and expenses	(24,9)	(5,6)
Disposal of tangible assets—selling price and book-value of disposal/ tangible assets	(4,8)	(7,4)
Subvention	—	—
Other expenses, net	(29,8)	(13,0)
Gain arising on step acquisition ⁽¹⁾	—	133,1
Other revenues	8,3	1,7
Expenses from prior periods ⁽²⁾	(22,4)	(7,5)
Restructuring costs	(6,7)	(0,1)
Reorganization and extraordinary costs	<u>(20,8)</u>	<u>127,2</u>
Total	<u>(50,5)</u>	<u>114,2</u>

(1) In the prior year, the gain from achieving control is linked to acquisition of Hot Telecom: the amount of the investment in HOT Telecom prior to achieving control, in accordance with the equity method of accounting has been revalued in accordance with the HOT's share price as of the said time, such that in the Altice VII financial statements as of December 31, 2011 income has been recorded on the revaluation of the investment in the affiliate, which became a consolidated company; as a result, HOT's assets and liabilities previously accounted for in accordance with equity method of accounting have been revalued for EUR 133,0 million.

(2) The increase in expenses from prior periods is mainly explained by fines and penalties paid by HOT relating to the early breakage of mortgage contracts and disputes with other suppliers. The total charge registered was of EUR 22.8 million, offset by a reversal in the provision for these charges for EUR 7.7 million, thus resulting in a net expense of EUR 14.9 million.

(3) Restructuring costs refer to the non-recurring costs incurred by Cabovisao in the year ended December 31, 2012, arising from the restructuring carried out at this company level, post-acquisition by the Group. The costs engaged are made up entirely of personnel costs and are associated with dismissal indemnities paid to employees.

ALTICE VII S.À R.L.
Notes to the consolidated financial statements (Continued)
December 31, 2012

27—Net finance costs

	December 31, 2012	December 31, 2011
	(in millions of euros)	
Cash and cash equivalent income	—	—
Gain arising on fair value financial instruments	0,4	6,4
Foreign exchange gains	24,7	6,8
Disposal of financial assets—selling price	4,5	3,0
Other financial incomes and expenses	0,9	0,4
Finance income	30,5	16,6
Interest charges on borrowings and overdrafts	(118,5)	(70,2)
Fair value financial instruments (losses)	(62,8)	—
Foreign exchange losses	(2,1)	(20,8)
Book-value of disposal/financial assets	(21,2)	(20,7)
Finance costs	(204,7)	(111,6)
Total	(174,1)	(95,0)

28—Transactions with non-controlling interests

On December 27, 2012, the Group successfully completed the take-private of HOT Telecom and thus the buyout of the non controlling interests in Cool Holding Limited. The total consideration paid to acquire this minority stake amounted to EUR 172,9 million.

On February 19, 2012 HOT distributed a dividend of NIS 365 million (EUR 73,4 million). Of this total amount, NIS 129 million (EUR 26,0 million) was paid to the non-controlling interests.

29—Average workforce

	December 31, 2012	December 31, 2011
Managers	268	280
Technicians	660	604
Employees	4 719	5 152
	5 647	6 036

30—Transaction with related parties

30.1 Trading and financial transaction

Transactions with related parties mainly related to the companies Adeintel, Titan consulting and DOK, all consulting firms specialized in the management and operations of telecom companies. The fees paid to these companies include recurring fees paid based on service level agreements established with Altice VII, one-off success fees for the successful completion of acquisitions or negotiations with banks

ALTICE VII S.À R.L.
Notes to the consolidated financial statements (Continued)
December 31, 2012

30—Transaction with related parties (Continued)

on debt contracts/bond issuance and reimbursement of any outlays and expenditures incurred by the employees of these companies when working on behalf of Altice VII.

<u>Consolidated Income and expenses</u>	<u>Revenue</u>		<u>Operating expenses</u>		<u>Financial expenses</u>	
	<u>December 31, 2011</u>	<u>December 31, 2012</u>	<u>December 31, 2011</u>	<u>December 31, 2012</u>	<u>December 31, 2011</u>	<u>December 31, 2012</u>
			(In millions of euros)			
Equity holders	0,4	0,2	(3,1)	(12,1)	—	—
Executive managers .	—	—	—	—	—	—
Remuneration and benefits in kind . . .	—	—	(1,1)	(2,5)	—	—
Associate companies .	—	—	—	—	(0,1)	—
TOTAL	<u>0,4</u>	<u>0,2</u>	<u>(4,2)</u>	<u>(14,6)</u>	<u>(0,1)</u>	<u>—</u>

<u>Assets</u>	<u>Loans and receivables</u>		<u>Trade accounts receivable and other</u>		<u>Current accounts</u>	
	<u>December 31, 2011</u>	<u>December 31, 2012</u>	<u>December 31, 2011</u>	<u>December 31, 2012</u>	<u>December 31, 2011</u>	<u>December 31, 2012</u>
			(In millions of euros)			
Equity holders	10,5	—	0,2	—	—	—
Executive managers .	2,7	2,7	—	—	—	—
Associate companies .	1,0	—	—	—	—	—
TOTAL	<u>13,7</u>	<u>2,7</u>	<u>0,2</u>	<u>—</u>	<u>—</u>	<u>—</u>

<u>Liabilities</u>	<u>Other financial liabilities</u>		<u>Trade accounts payable and other</u>		<u>Current accounts</u>	
	<u>December 31, 2011</u>	<u>December 31, 2012</u>	<u>December 31, 2011</u>	<u>December 31, 2012</u>	<u>December 31, 2011</u>	<u>December 31, 2012</u>
			(In millions of euros)			
Equity holders	—	—	4,5	—	—	0,6
Executive managers .	—	—	—	—	—	—
Associate companies .	—	—	—	—	—	—
TOTAL	<u>—</u>	<u>—</u>	<u>4,5</u>	<u>1,6</u>	<u>—</u>	<u>0,6</u>

30.2 Compensation of key management personnel

The compensation given to the managers, in respect of their duties as Chairman of the Executive Board or member of the Executive Board of Altice VII, for the financial year 2012, is EUR 1,7 million compared to EUR 0,9 million for the financial year 2011.

31—Contractual obligations and commercial commitments

31.1 Hot Telecom Commitments

31.1.1 Commitments

Royalties to the Ministry of Communications and other payments to the government

- (a) HOT is committed to pay annual royalties out of its overall income that are chargeable with royalties (hereinafter—the chargeable income) in accordance with the Telecommunications Regulations (Concessions)—1987. In accordance with the Telecommunications Regulations (Telecommunications and Broadcasting) (Royalties)—2001, HOT Telecom is required to pay annual royalties in respect of its income from in country operator services and HOT Mobile is required to

ALTICE VII S.À R.L.
Notes to the consolidated financial statements (Continued)
December 31, 2012

31—Contractual obligations and commercial commitments (Continued)

pay annual royalties in respect of its radio telephone services (less payments to another license holder in respect of reciprocal connection or roaming services). The royalty rates that HOT, HOT Telecom and HOT Mobile have each been charged to pay in respect of their chargeable income, as aforesaid, stood at 2,5% in 2007, 2% in 2008, 1,5% in 2009 and 1% in 2010. In accordance with a Temporary Order, the annual royalty rate for the years 2011 and 2012 stood at 1,75%.

In accordance with the Amendment to the Telecommunications Regulations (Concessions) and the Amendment to the Telecommunications Regulations (Telecommunications and Broadcasting) (Royalties) (Temporary Order)—2012, as from 2013 the royalty rate that is paid by HOT, HOT Telecom and HOT Mobile on its chargeable income, as aforesaid, stands at 0%.

- (b) In July 2001 the cables companies, including HOT, entered into a commitment under an agreement with the State of Israel on the subject of a solution to the disputes between the cable companies and the State in respect of the right of each company to operate the existing cables infrastructure in each of the concession areas after the end of the period of the concessions. It was stipulated in the agreement that the State undertakes to waive all of its claims and its rights in respect of the cables infrastructure such that each cables company would be the owner of all of the rights, including property rights, in the cables infrastructure that it held in the area of its concession and that it would have available to it the right to continue to operate it even at the end of the concession period. In consideration for this, it was stipulated that each company was to pay to the State, on an annual basis and for a period of 12 years (commencing on January 1, 2003), its relative share, as determined in the agreement, of an amount that is equivalent to the multiple of certain incomes (as determined in the agreement) of each of the cable companies on a graduated scale (in accordance with the level of income, as aforesaid) at a rate of from 0% to 4%. The relative share of each company can be altered by agreement between the cables companies.

In addition, it was stipulated that each company is to pay approximately 12% of the overall consideration from the sale of operations that are executed through the cables infrastructure or which touch upon the cables infrastructure (as defined in the agreement) for a period of 12 years. It was also stipulated in the agreement that in so far as HOT has received any amount whatsoever in consideration for the issuance of its shares to the public or to an external investor or in consideration for the sale of shares of another company from among the cables companies, part of the consideration from the issue or the sale, as aforesaid, is to serve as an advance payment for the payment of the relevant portion of the consideration that remains to be paid under the agreement, in accordance with a formula that will be determined by the parties by agreement. It is further stipulated in the agreement that it shall apply to the cables companies or to any company that is split or merged even if structural changes are made of any sort whatsoever, and accordingly, with the completion of the merger, the agreement applies to HOT as a merged company.

- (c) In accordance with the Wireless Telegraph Regulations (Licensing, Certification and Levies)—1978, HOT Mobile is required to pay a fixed annual payment for each frequency that it uses. HOT Mobile paid amounts of NIS 26 million and NIS 20 million in respect of the years 2012 and 2011 respectively (an amount of NIS 2 million in respect of December 2011).
- (d) The license to operate a broadcasting center: It is stipulated in the broadcasting center operating license that the license holder is to pay a fee for the license at such rates and at such times as may be determined by the Ministry of Communications in accordance with the Communications Law and the Wireless Telegraph Ordinance (New Version)—1972.

Other royalties

- (a) Within the framework of the Group's routine operations in the broadcasting field, the Group enters into commitments under arrangements and agreements under which the Group pays royalties to various authors' organizations. The amounts of the royalties that have been reflected by the Group

ALTICE VII S.À R.L.
Notes to the consolidated financial statements (Continued)
December 31, 2012

31—Contractual obligations and commercial commitments (Continued)

within this context in the years 2012, 2011 and 2010 amounted to NIS 42 million, NIS 43 million and NIS 47 million respectively.

- (b) On January 30, 2012 a draft of the Authors and Performers Law (Judgment on Royalties Issues) 2012 was placed before the Knesset. The draft law was intended to create a royalties court by empowering one of the District Court Judges to hear cases on royalties issues, royalty rates and disputes in royalty issues (in other words, a dispute on the issue of royalty rates between a collective management entity and a user or users of a repertoire).

This draft, if it is accepted, may have an implication for the issue of the payment of royalties to various organizations. As of the date of this report, HOT is unable to assess what the impact of the said legislation will be on its business results, if it is passed.

A commitment to invest in original productions

In accordance with the provisions of the Communications Law, the principles of communications and decisions by the Council, HOT is required, inter alia, to invest amounts in original productions at a rate of 8% of its annual income from subscription fees. During the course of the years 2010, 2011 and 2012 HOT complied with the investment rate that is required, as aforesaid.

It should be noted in this connection that the Communications Law has empowered the Council to determine the rate of investment that is required, provided that it may not exceed 12% and may not fall below 8% of the annual income from subscriber fees. In October 2011 the Council informed HOT that with effect from the year 2012 its income from subscriber fees, which form the basis for the calculation for the requirement to invest in original productions, will be deemed to include all of the payments that are paid by its subscribers in order to record broadcasts and to receive services, including income from users' terminal equipment and the installation thereof, whereas in accordance with the policy adopted by the Council up to such time the inclusion of income from terminal equipment for the purpose of this calculation was made conditional upon a mechanism that was based on the profitability of this income, and in past years the income from users' terminal equipment and the installation thereof was not included in the basis for the calculation for original productions. On January 12, 2012, the Council determined that HOT will be entitled to complete the amount of the additional investment for the year 2012 over three investment years.

Agreement to deploy and maintain a cables network

On January 1, 1990 and on May 1, 1989 Tevel International Transmission for Israel Ltd. and HOT Gold & Co. (hereinafter together—The cable companies) entered into commitments under agreements for the provision of planning, installation and maintenance services of the cables network with Bezeq (the provisions of both of the two said agreements are similar, and they will hereinafter in this section be called—the agreement). This agreement was endorsed to HOT Telecom as part of the merger agreement.

In accordance with the agreement, Bezeq, Tevel and HOT Gold planned the cables network, inter alia, based on Bezeq's available infrastructure, which was deployed in the areas of the concession at the time of the signing of the agreement. Tevel and HOT Gold supplied Bezeq with the base equipment (as defined in the agreement) that comprises the cables network whereas Bezeq supplied the additional equipment (as defined in the agreement) that is used for setting up the cables network.

In accordance with the agreement, a cables network was set up and deployed in a number of major cities across Israel, and Bezeq conducts the routine maintenance of the cables network and also provides malfunction repair services. The provisions of the agreement also relate, inter alia, to the possibility of the expansion of the cables network to additional facilities, the connection of new houses and of new neighborhoods.

ALTICE VII S.À R.L.
Notes to the consolidated financial statements (Continued)
December 31, 2012

31—Contractual obligations and commercial commitments (Continued)

The agreement will remain in force for the length of the period of the concession, and will continue to be in force if the concession or the rights in the concession are transferred or afforded to another, in whole or in part and directly or indirectly, during the course of the original concession period and during the extension of that period or after the end of it. Bezeq is only entitled to cancel the agreement in respect of a breach for which notice has been given in writing, and which has not been repaired within six months.

A consideration mechanism was set in the agreement, according to which HOT Telecom pays sums against the performance of Bezeq's commitments to setup, to maintain and to provide malfunction repair services, which are calculated in accordance with the length of the cables networks that have been deployed, in accordance with the various types of networks and it also makes non-recurring payments in respect of certain activities. In accordance with the agreement, the amount of the consideration in respect of the length of the cable, as aforesaid, is reduced by approximately 65% after 12 years from the time of the handing over of each section.

The total of the expenses recorded in HOT's accounting records for the network services payable to Bezeq in the years 2012, 2011 and 2010 amounted to NIS 48 million, NIS 46 million and NIS 43 million, respectively.

It should be noted that from time to time, during the routine course of business, disputes arise in connection with the implementation of the agreement, inter alia in respect of the division of the costs that are involved in the performance of some of the services that are supplied by the Bezeq company under the agreement, however the parties are continuing to operate in accordance with the agreement. It is further noted that over the course of the years additions have been signed to the agreement, primarily in connection with enhancement and upgrading work on the cables network.

Commitments to lease assets

The Group has commitments under agreements for the leasing of buildings and motor vehicles for various periods up to the end of the year 2020. The minimum future rental fees in respect of the rental contracts as of December 31, 2012, exclusive of the option period, are as follows:

	<u>NIS in millions</u>	<u>EUR in millions</u>
2013	186	37,7
2014	148	30,0
2015	120	24,3
2016	86	17,4
2017 and thereafter	304	61,7
TOTAL	<u>844</u>	<u>171,3</u>

On July 19, 2011 HOT's Board of Directors approved a commitment under agreements for the execution of the upgrading of the fiber optic infrastructure (FTTX). In accordance with the said commitment, HOT Telecom will purchase advanced optic equipment, work and services from third parties, in order to upgrade the infrastructures, including maintenance services, in accordance with the deployment and the timetables that will be agreed upon between the parties from time to time. The upgrading of the infrastructure, as aforesaid, will enable the expansion of the traffic capacity on the network, in favor of the supply of enhanced VOD services, the increasing of the number of channels that the Group can offer to its subscribers, faster internet services and it will also enable HOT to deal with increased demand for traffic capacity on the network in the future, which is expected to arrive as a result of the increased use of applications that require a considerable band width.

On May 27, 2010 a facility agreement was signed between HOT Mobile and Motorola for the purchase, licensing and installation of the infrastructure equipment (hardware and software) which is required in order to operate HOT Mobile's iDEN network. The agreement is in force for a period of five years from the time that it was signed (hereinafter—the initial period) and it will be renewed for additional periods of one

ALTICE VII S.À R.L.
Notes to the consolidated financial statements (Continued)
December 31, 2012

31—Contractual obligations and commercial commitments (Continued)

year each (or for a longer period that is agreed between the parties), unless a party to the agreement gives notice to the other party, 90 days before the end of the initial period, or one of the extension periods, as the case may be, of its desire to terminate the commitment. The agreement arranged the commitment between the parties for the purpose of the execution of the work orders that will be presented to Motorola, from time to time, by HOT Mobile for the purpose of the supply of equipment or software for the iDEN network.

Within the framework of the agreement, Motorola has undertaken that during the initial period it will hold an inventory of equipment that will enable it to immediately supply the components that are required for the proper functioning of HOT Mobile's iDEN network, and so that it will be capable of supplying HOT Mobile with the maintenance services for the infrastructure equipment and the software that is required to operate the network for a period of seven years from the signing of the agreement, subject to the purchase of the said maintenance services by HOT Mobile.

In consideration for Motorola's commitment to sell the equipment and the licenses to HOT Mobile at the prices that are denoted in the agreement, HOT Mobile has made a commitment to purchase the infrastructure equipment and the software that is required to operate the iDEN network exclusively from Motorola alone during the period of the agreement.

As part of the commitment with Motorola in respect of the infrastructure for the iDEN network, HOT Mobile has signed on a system maintenance agreement with Motorola as well as on an agreement for the maintenance of the system's hardware, which arrange the manner of the repair of malfunctions and the provision of support by Motorola for HOT Mobile's iDEN network.

In December 2011 the system maintenance agreement was extended for an additional period of three years, until the end of 2014.

On May 26, 2010, as part of the sale of the control in HOT Mobile to Altice, HOT Mobile entered into a commitment under an agreement with Mobility for the purchase of terminal equipment that supports the iDEN technology.

The agreement is in force for a period of 5 years and it will be renewed for additional periods of one year each time unless a party to the agreement gives notice to the other party, 60 days before the end of the initial period, or one of the extension periods, as the case may be, of its desire to terminate the commitment.

The agreement arranged a mechanism for the ordering and supply of the terminal equipment (including quarterly forecasts by HOT Mobile) with HOT Mobile being responsible for the importing of the terminal equipment from abroad.

The supplier has received an option and the right of first refusal for the repurchase from HOT Mobile of all of the terminal equipment that it may be holding at the time of the termination of the agreement, in accordance with a mechanism that was set in the agreement.

Within the framework of the preparations for the setting up of the new network, HOT Mobile entered into commitments under agreements with various suppliers for the purchase of terminal equipment that it will use on the UMTS network.

On June 16, 2011 HOT Mobile entered into a commitment with Nokia Siemens Networks Israel Ltd. (hereinafter—the supplier) for the setting up of the infrastructure for HOT Mobile's new network.

In accordance with the terms of the agreement, the supplier will plan and set up the new network for HOT Mobile as a turnkey contractor. In the first stage, which was completed in May 2012, the supplier completed the setting up of the systems that are required for the purpose of operating the new system with a coverage of approximately 30%, which is in excess of the extent of the coverage which is HOT Mobile required to provide (20%) in accordance with the terms of the tender within two years from the time of the receipt of the new radio telephone license. After the completion of the first stage, HOT Mobile

ALTICE VII S.À R.L.
Notes to the consolidated financial statements (Continued)
December 31, 2012

31—Contractual obligations and commercial commitments (Continued)

has expanded and is expanding the new network, both from the perspective of the coverage and also from the perspective of the LTE capability.

The agreement arranges the work arrangements between the supplier and HOT Mobile, the manner of the handing over of the system to HOT Mobile and the manner of the maintenance of the system by the supplier.

The agreement is in force for 15 years, and it contains warranties for the proper functioning of the components of the system for a period of two years from the time of the handing over of each component in accordance with the agreement, as well as warranties for the entire period of the agreement that the system will operate in accordance with the system requirements that HOT Mobile placed (in terms of availability, functioning and capacity), subject to their being a maintenance agreement in force between the parties.

In consideration for the completion of the first, second and third stages in accordance with the agreement and the performance of all of the supplier's commitments by the year 2013, the Group will pay the supplier an amount of USD 52 million, which amount does not include the expansion of the coverage and the capacity over and beyond what is stipulated in the agreement. The overall consideration in the agreement for all of the services up to the year 2017 is approximately USD 120 million, according to HOT Mobile's assessment.

On January 31, 2013, an addition to the agreement was signed, within the framework of which the payments that were supposed to be paid under the agreement have been deferred to a later date, subject to HOT Mobile's signing on debt notes, with HOT acting as guarantor. Within this framework, HOT Mobile has signed on confirmation for the final receipt of significant portions of the said project.

On October 27, 2011 an agreement was signed between HOT Mobile and Comverse Ltd. (hereinafter—Comverse), in accordance with which Comverse will supply HOT with a BSS system (a billing system that is integrated with the customer relations management (CRM) system) (hereinafter—The system) and Comverse will also supply HOT with hardware, software and services, including the operation and maintenance of the system. In consideration for Comverse's services, HOT Mobile will pay an amount of approximately USD 12.5 million. In January 2012, the parties signed on an addition to this agreement, in accordance with which Comverse is committed to allocating seven additional employees to be available for the project (instead of the manpower that HOT had to make available for the project), for a payment of USD 500 000.

On October 6, 2005, HOT Mobile won a tender for the provision of Mobile services to the IDF. Following Cellcom's winning of a tender, which was published by the Ministry of Defense in 2012 for the selection of a new mobile operator for the IDF, in the third quarter of 2012, a gradual transfer of IDF customers to Cellcom's network began. HOT Mobile's revenues from the IDF in the years 2010, 2011 and 2012 amounted to NIS 139,3 million, NIS 112.4 million and NIS 83,7 million, respectively, which constituted approximately 13,5%, 12,5% and 9,8% of HOT Mobile revenues in the said periods, respectively. Of the said revenues, an amount of NIS 10 million a year was in respect of the PTT services, which are supplied to the IDF without reference to the tender.

On May 30, 2012, HOT Mobile International Communications Ltd (hereinafter—HOT International), a wholly owned subsidiary of HOT Mobile's, received an operator's license for the provision of international telecommunications services (hereinafter—The international license). On January 6, 2013 HOT International received operational approval for starting to provide international telecommunications services in accordance with the international license and on January 8, 2013, notification of the opening of the services was sent to all of the operators.

Marketing and distribution (for iDEN technology products and services)

In 2012 HOT Mobile operated through marketing and distribution channels, which included: sales personnel, who were employed by HOT Mobile, inter alia, through services and sales centers, which

ALTICE VII S.À R.L.
Notes to the consolidated financial statements (Continued)
December 31, 2012

31—Contractual obligations and commercial commitments (Continued)

HOT Mobile operates across the country, a national distribution channel that works “door to door” using an external contractor and authorized marketing agents. In 2012 and as of the date of this report, HOT Mobile distributes its products via sales staff who are employed by it, the Israel Post company in some 200 branches and some 150 branches of the Menta chain in the Delek Group’s filling stations. In the ultra-orthodox sector, HOT Mobile operates through an external marketer who markets HOT Mobile’s products and services in that sector.

In addition, HOT Mobile is acting to recruit private subscribers through its business/institutional customers, by way of offering attractive packages and paths to the family members of the business/institutional customers.

Commitment with an external marketer

As aforesaid, in 2012, one of the distribution channels for the Group’s products and services in the iDEN field of operations was through an external contractor, S.D.M. Sales and Direct Marketing Ltd. (hereinafter—SDM), which provided HOT Mobile with marketing services for the iDEN products, through the operation of sales staff in order to market the iDEN products in the private and business markets, by operating a nationwide set-up, using a specialist marketing method involving initiated personal approaches whilst going door to door.

The consideration that SDM is entitled to is based on a fixed monthly consideration and commissions which are derived from SDM’s results in respect of the sales of the iDEN products.

The original commitment was up to December 31, 2013. However, on December 6, 2012 a compromise arrangement was signed between HOT Mobile and SDM, in accordance with which HOT Mobile will pay SDM an amount of NIS 8 million and the commitment between the parties will be terminated, with each party waiving its claims against the other party.

Marketing and distribution (for UMTS technology products and services)

The marketing and distribution of UMTS products is performed by means of HOT Mobile’s and HOT’s marketing and distribution channels and through third parties, within the restriction places in the radio telephone license.

Capitalized leasing rights on land from the Israel Lands Authority

Capitalized leasing rights on land from the Israel Lands Authority over an area of 20 713 square meters on which the Group’s buildings are located. The amount that is attributed to the capitalized rights is presented as a prepaid expenses in respect of operating leases in the balance sheet and is amortized over the period of the leases. The lease periods end in the years 2021-2045.

31.1.2 Guarantees and liens

As collateral for HOT’s commitments vis-à-vis the parent company under the credit agreement with it, the following charges have been placed

A floating charge on HOT’s assets.

A fixed charge on the shares in the subsidiary companies.

HOT Telecom has given a charge on some of its assets.

The said charges are in an unlimited amount, vis-à-vis HOT, the investee partnership—HOT Telecom and the subsidiary company—HOT Net, jointly and severally.

As collateral for the commitments of HOT, the investee partnership HOT Telecom and the subsidiary company HOT Net, first ranking floating charges have been placed in unlimited amounts in favor of the

ALTICE VII S.À R.L.
Notes to the consolidated financial statements (Continued)
December 31, 2012

31—Contractual obligations and commercial commitments (Continued)

borrowers, on all of the chargeable assets and the rights of companies in the Group and a fixed charge on the goodwill and the unpaid share capital of the Companies in the Group.

As collateral for HOT's commitments in respect of the royalties agreement, as set forth in section B(1) above, a second ranking floating charge has been placed in favor of the State.

As collateral for the Group's commitments, as determined in the Group's licenses and in the decisions by the Director and the Council, the Group has issued a number of guarantees, as follows:

Bank guarantees to the Ministry of Communications, in respect of the national operator license that was granted to HOT Telecom amounting to 8,4 million Dollars, in force until December 2017 and December 2025.

Guarantees in an amount of NIS 34 million (index-linked) to the Council in respect of the broadcasting license, which are in force until April and June 2014.

A bank guarantee in an amount of 2 million Dollars to the Director in respect of HOT's compliance with the terms of the merger as determined by the Director, which is in force until December 2014.

A bank guarantee in an amount of NIS 695 million, which was made available by HOT Mobile within the framework of its win in a tender for the allocation of frequencies and as collateral for its commitment in favor of the Ministry of Communications, which is in force until December 31, 2018.

In accordance with the wording of the guarantee that was written by the Ministry of Communications, there is no restriction in the guarantee on the endorsement, assignment or transfer of the guarantee to a third party. Furthermore, HOT Mobile has a duty to bear any expense that is involved in the exercise or the extension of the guarantee.

In the light of the aforesaid terms, HOT Mobile has signed on a letter of undertaking and endorsement vis-à-vis a bank, according to which HOT waives and is prevented from raising any claim against the bank in connection with the wording of the said guarantee, and it will indemnify and compensate the bank in respect of any expenses incurred for the purpose of conducting administrative and legal proceedings in connection with the said issues.

On November 28, 2011, HOT Mobile and the former parent company signed on an irrevocable letter of commitment vis-à-vis Bank Hapoalim Ltd. (hereinafter the bank). The letter of undertaking was signed as a condition for the making available of a bank guarantee in an amount of NIS 695 million, as collateral for HOT's commitments vis-à-vis the Ministry of Communications within the context of HOT's win in a frequencies tender for the setting up of a third generation mobile network (UMTS).

The Group has given a number of bank guarantees to various bodies in an overall amount of NIS 59 million.

Guarantees to HOT Telecom

The Group has given guarantees in a cumulative amount of 23 million Dollars as collateral for payments by HOT Telecom to the Cisco company.

The Group has given a guarantee in an amount of NIS 242 million (index-linked) as collateral for HOT Telecom's commitments vis-à-vis an interested party with which it has signed a rental agreement.

There exist mutual guarantees between HOT and companies in the Group, in unrestricted amounts, in favor of financial institutions as collateral for the repayment of the Group's liabilities to those financial institutions.

31.1.3 Other contingent liabilities

During the routine course of business, lawsuits have been filed against the companies in the Group and various legal proceedings are outstanding against it (hereinafter, "The Legal Claims").

ALTICE VII S.À R.L.
Notes to the consolidated financial statements (Continued)
December 31, 2012

31—Contractual obligations and commercial commitments (Continued)

In the opinion of the management of the Company and each of its subsidiaries, as at signature date, the amount of the additional exposure, in an amount of approximately NIS 3 billion (EUR 628,5 million) (over and above the provisions that have been recorded in these financial statements), as a result of the legal proceedings that have been filed against the Company's Subsidiaries on various matters, is as follows:

- (a) An amount of approximately NIS 1.7 billion (EUR 356,1 million) in respect of claims, in respect of which in the assessment of the Company's management, in reliance on the opinion of its legal advisors, the chances of their being accepted do not exceed 50%.
- (b) An amount of approximately NIS 0,1 billion (EUR 20,9 million) in respect of claims, which it is not yet possible, at this stage, to make an assessment, the main ones being in connection with applications for the approval of class actions that were presented close to the date of the financial statements
- (c) An amount of approximately NIS 1,42 billion (EUR 297,5 million) in respect of claims which, in the assessment of the Company's management, in reliance upon the opinions of its legal advisors, their chances of being accepted exceed 50% and in respect of which a provision has been recorded in accordance with the assessments of the managements of the Company's Subsidiaries, as aforesaid.

The following is an abbreviated summary of the Group's contingent liabilities effective as of signature date, in accordance with groupings having similar characteristics:

The nature of the lawsuit (EUR in millions)	The amount of the additional exposure in excess of the provision recorded as of signature date	The amount of the lawsuits that cannot be assessed and which were presented close to the date of the financial statements (primarily applications for approval as class actions)
Customers	574	21
Lawsuits after the balance sheet date in respect of customers	33	33
Suppliers	13	5
Employees	1	—
The merger transaction	50	—
Total	671	59

31.2 Cabovisao commitments

31.2.1 Contingent assets

During the year ended December 31, 2012, Cabovisao made the decision not to pay any fees charged by municipalities, in addition to TMDP (Fees due for rights and charges related to the deployment of, passage within or crossing of systems, equipment and other resources of providers of publicly available electronic communications networks and services at a fixed location, of a public or private municipal domain). On December 31, 2012, Cabovisao had outstanding claims against several municipalities, totaling EUR 3,6 million. To present date, Cabovisao received 102 004 Euros from seven municipalities.

ALTICE VII S.À R.L.
Notes to the consolidated financial statements (Continued)
December 31, 2012

31—Contractual obligations and commercial commitments (Continued)

31.2.2 Contingent liabilities

31.2.2.1 Bank guarantees

	December 31, 2012 In millions of euros
Tax Authority	8,4
City Council	0,9
Third Parties	<u>0,01</u>
Total	<u>9,3</u>

31.2.2.2 Real guarantees

On December 31, 2012, Cabovisao issued a bond amounting to EUR 25 million which was fully underwritten by Goldman Sachs International together with a financial first degree collateral of all bank accounts held by Cabovisao (except the bank deposit account in HSBC France and a current account with Caixa Geral de Depositos, S.A.) and pledge the shares representing Cabovisao's share capital and equity holders' rights.

31.2.2.3 Other contingent liabilities

As a result of the refusal by Cabovisao to pay the municipal taxes referred to above (since September 2010), the municipality of Almada initiated a process executive for payment of fees from 2006 to 2009, amounting to approximately EUR 0,7 million. It is the understanding of the Board of Managers, based on the opinion of its legal counsel, that the likelihood of loss is very low in the process.

31.2.2.4 Contingent assets

Cabovisao has outstanding claims against various municipalities for municipal taxes that it deems were charged illegally. The amount of such outstanding claims was EUR 3.6 million for the year ended December 31, 2012, of which EUR 0,1 million have been received from seven municipalities, while recovery is on-going with others.

31.3 Coditel Holding commitments

As of December 31, 2012, off balance sheet commitments include:

The shares, bank accounts and receivables of Coditel Brabant S.p.r.l. and Coditel S.à r.l. have been pledged. Coditel Holding is not allowed to pledge these assets as security for other borrowings or to sell them to another entity.

31.4 Others

The shares, bank accounts and receivables of Altice VII and its following subsidiaries Altice Finco S.A., Altice Financing S.A., Cool Holdings Ltd S.A., H.Hadaros 2012 Ltd., Hot Telecommunications System Ltd, Cabovisao S.A., Altice Blue Two S.A.S. and its subsidiaries, Coditel Holding S.A. and its subsidiaries have been pledged for the issued Senior Secured Notes and Senior Notes. The Company is not allowed to pledge these assets as security for other borrowings or to sell them to another entity.

32—Statutory Auditors' fees

In 2012, an amount of EUR 0,3 million was paid to various network affiliates of the Group's auditors, of which 0,2 million was paid as fees for audit services and EUR 0,1 million as fees for non-audit fee services.

ALTICE VII S.À R.L.
Notes to the consolidated financial statements (Continued)
December 31, 2012

33—Going concern

During the year ended December 31, 2012, the company had a net current liability position of EUR 221,4 million (mainly due to other payables of EUR 118,7 million and trade payables of EUR 311,3 million), a net loss of EUR 189,8 million (down from a net gain of EUR 123,9 million in FY11), positive cash flow from operations of EUR 467,8 and negative working capital of EUR 230,1 million. The positive cash flow from operations balance was mainly due to strong earnings growth and EBITDA generation. The net working capital of EUR 230,1 million is mainly driven by trade receivables and payables. The net loss recorded in FY12 was mainly driven by increased depreciation and amortisation charges as compared to FY11 (+EUR 211,7 million), increased financial charges and with the issuance of public debt at the time of the take private operation of HOT Telecom. In addition to this, an exceptional revenue was recognised in FY11, owing to the switch from equity method to global integration consolidation of HOT Telecom, which was non-recurrent in FY12 (an impact of EUR 133,1 million).

The negative working capital position is structural and follows industry norms. Customers generally pay subscription revenues early or mid-month, with short DSOs (Days of Sales Outstanding) and suppliers are paid in the beginning of the following month, thus generating a negative working capital, as evidenced by the difference in the level of receivables and payables (EUR 150,8 million vs. EUR 311,3 million). Payables due the following month are covered by revenues and operating cash (if needed). As of December 31, 2012, the company had many short term loan payments (< 1y), and long term debt was refinanced at the end of 2012 and in June 2013.

Despite the net current liability position, Management is of the view that the company will continue to act as a going concern for 12 months from the date of approval of these financial statements based on the following:

The Group has a strong track record of generating positive operating income before amortisation and depreciation and generated strong positive operating cash flows in 2012 (EUR 467,8 million). Operating income before D&A amounted to EUR 403,2 million, an increase of 35% compared to FY11, thus reaffirming management's ability to drive profits in the different operating companies.

The Group had a marked improvement in cash reserves at the end of 2012 compared to December 31, 2011 (EUR 129,6 million vs. EUR 19,8 million), which would allow it to cover any urgent cash needs. Additionally, the Group had access to a revolving credit facility ("RCF") of up to USD 80,0 million (EUR 60,9 million).

The Group has sufficient reserves to absorb the impact of the net loss incurred in the year ended December 31, 2012. Net equity amounted to EUR 285,7 million on December 31, 2012.

In addition to the points enumerated above, the Group has implemented a new budgeting exercise, with monthly account reviews with CFOs of operating companies to track budget accuracy. This exercise will be complemented by a mid-year reforecast based on real first semester numbers.

34—Events after the reporting period

On May 31, 2013, Altice Holdings entered into a sale and purchase agreement to acquire Winreason (the "ONI Purchase Agreement"), the owner of the Portuguese telecommunications group, ONI, pursuant to which Cabovisao purchased all of the outstanding shares of ONI and refinanced the outstanding indebtedness of ONI (the "ONI Transaction"). The deal was consummated on August 8, 2013.

On June 7, 2013, Altice VII and certain of its subsidiaries entered into a sale and purchase agreement (the "Outremer Purchase Agreement") with the owners of OMT Invest and certain of its affiliates pursuant to which (i) the Group had agreed to purchase all of the outstanding share capital of OMT Invest other than shares to be contributed separately pursuant to the Outremer Investment Agreement on completion of the Outremer Transaction and (ii) all of the outstanding indebtedness of OMT Invest and its subsidiaries were to be refinanced using a portion of the proceeds of the June 24, 2013 bond issuance (see below). The parties to the Outremer Purchase Agreement entered into an investment agreement (the "Outremer Investment Agreement") pursuant to which (i) the Group contributed all of

ALTICE VII S.À R.L.
Notes to the consolidated financial statements (Continued)
December 31, 2012

34—Events after the reporting period (Continued)

the outstanding share capital of Le Cable Martinique and Le Cable Guadeloupe and (ii) managers of OMT Invest contributed all of the outstanding shares of OMT Invest not sold to the Group under the Outremer Purchase Agreement. The transaction was completed on the July 5, 2013.

On June 14, 2013, Altice Finco issued EUR 250 million aggregate principal amount of its 9% senior notes due 2023 (the “2013 Senior Notes”).

On June 24, 2013, Altice Financing entered into a senior secured term loan credit facility (as amended from time to time, the “2013 Term Loan Facility”) which provides for U.S. dollar term loans (the “2013 Term Loans”) up to an aggregate principal amount equivalent to USD 1 034 million. Altice Financing may draw under the 2013 Term Loan, in up to four tranches, at any time on or prior to November 30, 2013, as long as, among other things, the incurrence of the indebtedness would have been permitted by the covenants in the existing Altice Financing debt documents. On July 2, 2013 and July 5, 2013, Altice Financing borrowed USD 584,2 million and U.S. dollar-equivalent USD 81,9 million under the 2013 Term Loan (the “First Draw”). The proceeds, together with the proceeds of the 2013 Senior Notes and cash on the balance sheet of the Group were applied to complete the Cabovisao Refinancing, the Coditel Refinancing, the Le Cable Refinancing and the ABO Refinancing on July 2, 2013 (described above), and the Outremer Transaction on July 5, 2013.

On March 7, 2013, Altice VII purchased the 40% remaining shares held by Codilink S.à r.l in Altice Portugal S.A..

Cabovisao Refinancing

On July 2, 2013, Altice Financing repaid the outstanding indebtedness under the existing Cabovisao Bridge Facility of EUR 203 million (the “Cabovisao Refinancing”).

Coditel Refinancing

In July 2, 2013, Coditel Holding prepaid approximately EUR 7 million of its EUR 138 million indebtedness outstanding under the existing Coditel Senior Facility and Altice Holdings purchased substantially all of the remaining interests of the existing lenders under the existing Coditel Senior Facility.

ABO Refinancing

On July 2, 2013 ABO refinanced approximately EUR 70 million of its existing indebtedness to third parties (the “ABO Refinancing”).

WSG and MTVC Refinancing

WSG and MTVC are indirect subsidiaries of the Group. On July 2, 2013, Altice Pool refinanced approximately (x) EUR 8 million of indebtedness of MTVC and (y) EUR 14 million of indebtedness of WSG (collectively, the “Le Cable Refinancing”).

MCS & SportV

In October 2013, the Group completed the acquisition of two sports based content delivery channels, Ma Chaine Sport and SportV. This acquisition was completed in October 2013 and total consideration paid amounted to EUR 15 million. These channels are focussed on providing quality sports programming and are intended to serve as a platform for the potential new business segment for the Company (Content). The acquisition was fully financed using equity holders’ equity.

ALTICE VII S.À R.L.
Notes to the consolidated financial statements (Continued)
December 31, 2012

34—Events after the reporting period (Continued)

Tricom

In November 2013, the Group confirmed that it has signed an agreement to acquire a controlling stake in Tricom, the second largest cable operator in the Dominican Republic. This acquisition is expected to explore significant synergies with the Group's French Overseas Territories operations.

Network Sharing Agreement

On November 8, 2013, HOT Mobile entered in to a network sharing agreement (the "Network Sharing Agreement") with Partner Communications Company Ltd. Pursuant to the terms of the Network Sharing Agreement, HOT Mobile and Partner will each own 50% of a newly formed limited partnership, which shall hold, develop and operate an advanced shared mobile network for both companies. Network Sharing Agreement enables HOT Mobile and Partner to share antennas and frequencies, and facilitates optimum utilization of the spectrum. In addition, while HOT Mobile and Partner will continue to maintain and operate separate core networks, Partner has agreed to grant HOT Mobile a right of use in its cellular communication network for the purpose of providing nation-wide cellular coverage to HOT Mobile's customers.

Also, as part of the engagement the Group will grant a guarantee on behalf of Hot Mobile Ltd. In addition, in several cases as determined in the agreements the Company will be required to grant an additional guarantee for example in case of a change in the finance ranking of the Company. The Network Sharing Agreement is subject to regulatory approvals of the Ministry of communication and the restrictive trade practices controller, which as of the balance sheet date were not achieved.

As a result of this new agreement, the existing agreement with Pelephone will be phased out until the contractual end of the agreement in 2014.

Reduction of Guarantees to the State of Israel

HOT Mobile has informed the Ministry of Communications that as of September 26, 2013, it had reached an average market share in the private sector of 11,3%, constituting an addition of 9.52% on HOT Mobile's market share at the time of the expansion of the general license for the provision of mobile radio telephone services under the cellular method (hereinafter—the license), on September 26, 2011.

In the light of HOT Mobile achieving the market share that is required as of the time of the first check, HOT Mobile has requested the Ministry to reduce the amount of the guarantee that was deposited by HOT Mobile, from an amount of NIS 695,0 (EUR 144,6 million) million to an amount of NIS 80 (EUR 16,6 million) million. This was in addition to an amount of NIS 10,0 (EUR 2,0 million) million that it paid upon the receipt of the license.

As of the date of the approval of the financial statements, the response of the Ministry of Communications has not yet been received and the guarantee therefore remained in the same amount.

To the Board of Managers of
Altice International S.à r.l.
3, boulevard Royal
L-2449 Luxembourg

**ASSURANCE REPORT OF THE REVISEUR D'ENTREPRISES AGREE
ON THE COMPILATION OF UNAUDITED ILLUSTRATIVE AGGREGATED
SELECTED COMBINED FINANCIAL INFORMATION**

We have completed our assurance engagement to report on the compilation of the Unaudited Illustrative Aggregated Selected Combined Financial Information of Altice International S.à r.l. (the "Company") by its Board of Managers (the "Board of Managers"). The Unaudited Illustrative Aggregated Selected Combined Financial Information consists of selected statement of income and cash flow items for the years ended December 31, 2011 and December 31, 2012 (the "Selected Items") and related notes as set out in the Offering Memorandum to be issued by the Company on or around January 22, 2015. The applicable criteria on the basis of which the Board of Managers has compiled Unaudited Illustrative Aggregated Selected Combined Financial Information are described in Note 1 thereto.

The Unaudited Illustrative Aggregated Selected Combined Financial Information has been compiled by the Board of Managers to illustrate the impact of the transactions set out in Note 1 on the Selected Items as if the transactions described in Note 1 (the "Transactions") had taken place on January 1, 2011. As part of this process, the Selected Items pertaining to the Company have been extracted by the Board of Managers from the Company's consolidated financial statements as of and for the years ended December 31, 2012 and December 31, 2011 on which an audit report has been published. Also, the Selected Items pertaining to the entities involved in the Transactions have been extracted by the Board of Managers from the relevant financial statements described in Note 1 to the Unaudited Illustrative Aggregated Selected Combined Financial Information.

Board of Director's responsibility for the Unaudited Illustrative Aggregated Selected Combined Financial Information

The Board of Managers is responsible for compiling the Unaudited Illustrative Aggregated Selected Combined Financial Information in accordance with the basis of preparation described in Note 1.

Responsibility of the réviseur d'entreprises agréé

Our responsibility is to express an opinion, about whether the Unaudited Illustrative Aggregated Selected Combined Financial Information has been compiled, in all material respects, by the Board of Managers in accordance with the basis of preparation described in Note 1.

We conducted our engagement in accordance with International Standard on Assurance Engagements (ISAE) 3420, *Assurance Engagements to Report on the Compilation of Pro Forma Financial Information Included in a Prospectus*, issued by the International Auditing and Assurance Standards Board. This standard requires that the *réviseur d'entreprises agréé* complies with ethical requirements and plans and performs procedures to obtain reasonable assurance about whether the Board of Managers has compiled, in all material respects, the Unaudited Illustrative Aggregated Selected Combined Financial Information in accordance with the basis of preparation described in Note 1.

For purposes of this engagement, we are not responsible for updating or reissuing any reports or opinions on any historical financial information used in compiling the Unaudited Illustrative Aggregated Selected Combined Financial Information, nor have we, in the course of this engagement, performed an audit or review of the financial information used in compiling the Unaudited Illustrative Aggregated Selected Combined Financial Information.

The purpose of the Unaudited Illustrative Aggregated Selected Combined Financial Information included in an Offering Memorandum is solely to illustrate the impact of significant events or transactions on unadjusted financial information of the entity as if the events have occurred or the transactions had been undertaken at an earlier date selected for purposes of the illustration. Accordingly, we do not provide any assurance that the actual outcome of the events or transactions at any date would have been as presented.

A reasonable assurance engagement to report on whether the Unaudited Illustrative Aggregated Selected Combined Financial Information has been compiled, in all material respects, in accordance

with the criteria within a defined basis of preparation involves performing procedures to assess whether the applicable criteria used by the Board of Managers in the compilation of the Unaudited Illustrative Aggregated Selected Combined Financial Information provide a reasonable basis for presenting the significant effects directly attributable to the events or transactions, and to obtain sufficient appropriate evidence about whether:

- The related pro forma adjustments give appropriate effect to those criteria; and
- The Unaudited Illustrative Aggregated Selected Combined Financial Information reflects the proper application of those adjustments to the unadjusted financial information.

The procedures selected depend on the judgment of the *réviseur d'entreprises agréé*, having regard to the *réviseur d'entreprise agréé*'s understanding of the nature of the company, the event or transaction in respect of which the Unaudited Illustrative Aggregated Selected Combined Financial Information has been compiled, and other relevant engagement circumstances. The engagement also involves evaluating the overall presentation of the Unaudited Illustrative Aggregated Selected Combined Financial Information.

We believe that the evidence we have obtained is sufficient and appropriate to provide a basis for our opinion.

Opinion

In our opinion, the Unaudited Illustrative Aggregated Selected Combined Financial Information has been compiled, in all material respects, in accordance with the basis of preparation described in Note 1 thereto.

Restriction on distribution and use

The Unaudited Illustrative Aggregated Selected Combined Financial Information has been prepared for the purposes of inclusion within the Offering Memorandum issued by the Company on or around January 22, 2015. As a result, the Unaudited Illustrative Aggregated Selected Combined Financial Information may not be suitable for any other purpose. Our report has been prepared solely for inclusion in the aforementioned Offering Memorandum and may not be suitable for any other purpose.

For Deloitte Audit, Cabinet de révision agréé

John Psaila, *Réviseur d'entreprises agréé*

Partner

January 22, 2015

ILLUSTRATIVE AGGREGATED SELECTED FINANCIAL INFORMATION OF THE GROUP

The following unaudited illustrative aggregated statements of income as of and for the years ended December 31, 2011 and 2012 (collectively, the “Illustrative Aggregated Selected Financial Information”) present an aggregation of the amounts as derived from the audited historical consolidated financial statements of Altice VII as of and for the years ended December 31, 2011 and 2012 (the “Historical Financial Statements”), the audited or reviewed financial information of each of the business undertakings acquired between January 1, 2011 and October 15, 2013 if such amounts are not already included within the Historical Financial Statements (the “Pre-Acquisition Financial Information”) and any adjustments needed to align the Pre-Acquisition Financial Statement with the measurement and recognition criteria of IFRS and the accounting policies adopted for the Historical Financial Statements. Such adjustments are made where the measurements and recognition criteria and the accounting policy elections used for the Pre-Acquisition Financial Information differ substantially from the corresponding criteria applicable under the IFRS and the accounting policies used for the purposes of the Historical Financial Statements. These financial statements have not been audited or reviewed. The Illustrative Aggregated Selected Financial Information does not aggregate the financial information of Mobius Group Tricom or ODO. For further information regarding the basis of the preparation of the Illustrative Aggregated Selected Financial Information, including certain limitations with respect to such financial information, please refer to “*Presentation of Financial and Other Information—Illustrative Aggregated Selected Financial Information*” and Note 1 below.

The Illustrative Aggregated Selected Financial Information should be read in conjunction with the assumptions underlying the adjustments which are described in the notes accompanying them below as well as the historical and other financial statements of Altice VII included elsewhere in the Offering Memorandum. See “*Presentation of Financial and Other Information—Financial Data*”.

ILLUSTRATIVE AGGREGATED SELECTED FINANCIAL INFORMATION

For the year ended December 31, 2012

For the year ended December 31, 2012	Note	Altice VII S.à r.l.	Altice VII Aggregated Adj. (in € millions)	Altice VII aggregated
Revenues	3b	1,092.4	349.4	1,441.8
Purchases and subcontracting services		(302.1)	(142.3)	(444.4)
Gross profit	3c	790.3	207.1	997.4
Other operating expenses	3d	(248.9)	(66.4)	(315.3)
Other sales and marketing expenses	3d	(80.1)	(22.7)	(102.8)
General and administrative expenses	3d	(58.1)	(27.0)	(85.1)
Operating income before depreciation & amortization . .	3e	403.2	91.0	494.2
Capital expenditures	3f	347.0	50.8	397.8

For the year ended December 31, 2011

For the year ended December 31, 2011		Altice VII S.à r.l.	Altice VII Aggregated Adj. (in € millions)	Altice VII aggregated
Revenues	3b	784.2	642.0	1,426.2
Purchases and subcontracting services		(175.4)	(224.2)	(399.6)
Gross profit	3c	608.8	417.8	1,026.6
Other operating expenses	3d	(195.4)	(124.1)	(319.5)
Other sales and marketing expenses	3d	(64.4)	(44.5)	(108.9)
General and administrative expenses	3d	(51.2)	(49.7)	(100.9)
Operating income before depreciation & amortisation . . .	3e	297.8	199.4	497.2
Capital expenditures	3f	189.8	104.0	293.8

1. BASIS OF PREPARATION

(a) Compilation of available financial information for the Company and the Acquired Businesses

The Illustrative Aggregated Selected Financial Information for the years ended December 31, 2011 and 2012 has been compiled under the responsibility of the Board of Managers of Altice VII S.à r.l. (the “Company”); by aggregating for each of the selected financial statement items the following:

- the amounts relating to the selected financial statement items as derived from the audited historical consolidated financial statements of the Company as of and for each of the years ended December 31, 2011 and 2012 (collectively the “Historical Financial Statements”) drawn up in accordance with International Financial Reporting Standards as adopted in the European Union (“IFRS”);
- the amounts relating to the selected financial statement items as derived from the audited or reviewed financial information of each of the business undertakings acquired between January 1, 2011 and October 15, 2013 (the “Acquired Businesses”) for the periods during which such amounts are not included within the Historical Financial Statements (collectively the “the Pre-Acquisition Financial Information”); and
- the amounts relating to adjustments that have been identified for the purposes of aligning the Pre-Acquisition Financial Information with the measurement and recognition criteria of IFRS and the accounting policies adopted by the Company for the purposes of the Historical Financial Statements (the “Alignment Adjustments”).

(b) The Pre-Acquisition Financial Information

The Pre-Acquisition Financial Information has been derived from the following financial information pertaining to the Acquired Businesses:

Year ended December 31, 2011

- the financial statements of Outremer Telecom S.A. (“OMT”) as of and for the year ended December 31, 2011 drawn up in accordance with IFRS. Such financial statements have been audited by Constantin Associes and Ernst & Young et Autres who have issued an unmodified audit opinion thereon on March 23, 2012;
- the financial statements of Coditel Brabant S.p.r.l. (“CodiBe”) as of and for the period ended July 31, 2011 drawn up in accordance with accounting policies and practices applicable in Belgium (“Belgian GAAP”). Such financial statements have been audited by Deloitte Réviseurs d’entreprises S.c r.l. who have issued an unmodified audit opinion thereon on October 1, 2011;
- the annual accounts of Coditel S.à r.l. (“CodiLu”) as of and for the period ended July 31, 2011 drawn up in accordance with accounting policies and practices applicable in Luxembourg (“Lux GAAP”). Such annual accounts have been audited by Deloitte S.A. who have issued an unmodified audit opinion thereon on May 31, 2012;
- the special-purpose financial statements of Cabovisao S.A. as of and for the year ended December 31, 2011 drawn up in accordance with IASB IFRS. Such financial statements have been audited by Baker Tilly, PG & Associados, SROC S.A. have issued a modified review opinion thereon on November 21, 2013; and
- the special-purpose consolidated financial statements of Winreason S.A. as of and for the year ended December 31, 2011 drawn up in accordance with IFRS. Such financial statements have been audited by Deloitte & Associados SROC, S.A. who have issued a modified audit opinion thereon on September 25, 2013; and
- the financial statements of Ma Chaîne Sport S.A.S. (“MCS”) as of and for the year ended December 31, 2011 drawn up in accordance with French GAAP. Such financial statements have been audited by KPMG Audit who have issued an unmodified audit opinion thereon on May 31, 2012.

Year ended December 31, 2012

- the financial statements of Outremer Telecom S.A. (“OMT”) as of and for the year ended December 31, 2012 drawn up in accordance with IFRS. Such financial statements have been audited by Constantin Associes and Ernst & Young et Autres who have issued an unmodified audit opinion thereon on April 18, 2013;
- the special-purpose financial statements of Cabovisao S.A. as of and for the period ended February 29, 2012 drawn up in accordance with IASB IFRS. Such financial statements have been reviewed by Baker Tilly, PG & Associados, SROC, S.A. who have issued a modified audit opinion thereon on October 14, 2013;
- the special-purpose consolidated financial statements of Winreason S.A. as of and for the year ended December 31, 2012 drawn up in accordance with IFRS. Such financial statements have been audited by Deloitte & Associados SROC, S.A. who have issued a modified audit opinion thereon on September 25, 2013;
- the financial statements of Ma Chaîne Sport S.A.S. (“MCS”) as of and for the year ended December 31, 2012 drawn up in accordance with French GAAP. Such financial statements have been audited by KPMG Audit who have issued an unmodified audit opinion thereon on May 23, 2013; and
- the unaudited financial statements of Sportv as of and for the year ended December 31, 2012 drawn up in accordance with IFRS.

The presentation and classification of the selected financial statement items that have been derived from the historical financial statements of the Acquired Businesses have been modified in order to align with the presentation and classification criteria that have been retained for the purposes of the Historical

Financial Statements of the Company. Accordingly, certain reclassifications discussed below have been made to the selected financial statement items derived from the historical financial statements of the Acquired Businesses to present the Illustrative Aggregated Selected Financial Information that is aligned with the presentation and classification criteria applied by the Company in the preparation of its Historical Consolidated Financial Information.

(c) The Alignment Adjustments

The Alignment Adjustments are primarily composed of the following elements:

- In those instances where the amounts included in the Pre-Acquisition Financial Information have been drawn up in accordance with an accounting framework the measurement and recognition criteria of which differs substantially from the corresponding criteria applicable under IFRS, alignment adjustments have been prepared by the Board of Managers in order to substantially align the contribution of the Acquired Businesses to the Illustrative Aggregated Selected Financial Information with the measurement and recognition criteria of IFRS. The key adjustments and any exceptions thereto are described in note 2.
- In those instances where the amounts included in the Pre-Acquisition Financial Information have been drawn up in accordance with accounting policy elections that differ substantially from the accounting policies retained by the Company for the purposes of the Historical Financial Statements no alignment adjustments have been prepared by the Board of Managers in order to substantially align the contribution of the Acquired Businesses to the Illustrative Aggregated Selected Financial Information with the accounting policies retained by the Company.

(d) Translation of historical financial information denominated in currencies other than the Euro

The historical financial statements of HOT, from which amounts have been derived in preparing the Illustrative Aggregated Selected Financial Information for the year ended December 31, 2011, have been drawn up in Israeli Shekel (“NIS”). The relevant amounts have been translated into Euro (“EUR”), for the purposes of their inclusion within the Illustrative Aggregated Selected Financial Information, using the average daily exchange rates over the relevant period as described below:

Period from January 1, 2011 to March 16, 2011 1 NIS = 0.201 EUR

(e) Key limitations to the basis of preparation

The Illustrative Aggregated Selected Financial Information for the years ended December 31, 2011 and 2012 do not purport to represent the performance, cash flows or financial position that the Company would have reported had the Acquired Businesses been subsidiaries of the Company during the entire length of the periods presented. They also do not purport to represent the performance and cash flows of the Company for any future period or its financial position at any future date. The Illustrative Aggregated Selected Financial Information do not reflect the effect of any anticipated synergies and efficiencies associated with combining the ONI group, the OMT Group and the other subsidiaries of the Altice VII Group.

In addition, only a complete set of consolidated financial statements as defined in IAS 1 can provide a fair presentation of the financial position, financial performance and cash flows of an entity in accordance with IFRS. The Illustrative Aggregated Selected Financial Information do not purport to represent a complete set of financial statements drawn up in accordance with IFRS, and are solely prepared to illustrate the aggregation of the Historical Financial Statements with the Pre-Acquisition Financial Information.

In preparing the Illustrative Aggregated Selected Financial Information, the Board of Managers has determined that the extent of any transactions between the Company and the Acquired Businesses is negligible, and hence no adjustments relating to the elimination of such transactions or balances have been made.

2. ACCOUNTING FRAMEWORK ALIGNMENT ADJUSTMENTS

(a) Revenues and expenses

IFRS requires discounts to be recognized as a reduction of revenues over the length of the contractual arrangement with the customer. In addition, certain expenses may be restated as capital expenditure based on the nature of the expense.

Alignment adjustment in relation to Coditel S.à r.l.

The Pre-Acquisition Financial Information relating to Coditel S.à r.l. is drawn up in accordance with the measurement and recognition criteria of Lux GAAP, which does not require mandatory accounting for disconnection fees. Had Coditel S.à r.l. adopted the aforementioned measurement and recognition criteria of IFRS, illustrative adjustments result in an increase in other operating expenses of 0.1 million EUR for the year ended December 31, 2011.

The Pre-Acquisition Financial Information relating to Coditel S.à r.l. relates to the period from January 1, 2011 to July 31, 2011. For the purpose of building the Selected Aggregated Financial Information the Board of Managers recorded the following adjustments which reflect the activity for the period from July 1, 2011 to July 31, 2011: (i) revenues decreased by 1.4 million EUR; (ii) other operating expenses decreased by 0.1 million EUR; (iii) general and administrative expenses decreased by 0.1 million EUR.

Alignment adjustment in relation to Coditel Brabant S.p.r.l.

The Pre-Acquisition Financial Information relating to Coditel Brabant S.p.r.l. is drawn up in accordance with the measurement and recognition criteria of Belgian GAAP, which permits such discounts to be recognized immediately as a reduction to revenues at inception of the contract. Alignment adjustments have been made to record the changes that would result to revenues had Coditel S.p.r.l. adopted the aforementioned measurement and recognition criteria of IFRS. Such illustrative adjustments result in increase to revenue of 0.2 thousand EUR for the year ended December 31, 2011. In addition, Coditel Brabant also applied IFRS adjustments related to the accounting for employee pension benefits and disconnection fees, which resulted in an increase in other operating expenses of 0.3 million EUR.

The Pre-Acquisition Financial Information relating to Coditel Brabant S.p.r.l. relates to the period from January 1, 2011 to July 31, 2011. For the purpose of building the Selected Aggregated Financial Information the Board of Managers recorded the following adjustments which reflect the activity for the period from July 1, 2011 to July 31, 2011: (i) revenues decreased by 4.0 million EUR; (ii) purchases and subcontracting services decreased by 0.6 million EUR; (iii) other operating expenses decreased by 0.4 million EUR; (iv) other sales and marketing expenses decreased by 0.2 million EUR; and (v) general and administrative expenses decreased by 0.2 million EUR.

Alignment adjustment in relation to Ma Chaîne Sport SAS.

The Pre-Acquisition Financial Information relating to Ma Chaîne Sport S.A.S. is drawn up in accordance with the measurement and recognition criteria of French GAAP, which permits no capitalisation of costs related to the acquisition of content for delivery to final customers. Given the exclusive nature of such content, IFRS rules allow the capitalisation and recognition of such costs as intangible assets. Had Ma Chaîne Sport adopted the aforementioned measurement and recognition criteria of IFRS, such illustrative adjustments result in a decrease in purchasing and subcontracting costs of 3.4 million EUR and in other operating expenses of 1.1 million EUR for the year ended December 31, 2011 and 4.7 million EUR and 1.6 million EUR for the year ended December 31, 2012.

3. SUPPLEMENTS NOTES TO THE ILLUSTRATIVE STATEMENT OF SELECTED AGGREGATED FINANCIAL INFORMATION

The Illustrative Aggregated Selected Financial Information for the years ended December 31, 2011 and 2012 has been approved by the Board of Managers of Altice VII S.à r.l. (the "Company"), as follows:

(a) Selected Aggregated Statement of Income Items and Selected Aggregated Statement of Cash Flow Items

For the year ended December 31, 2012		Altice VII S.à r.l.	Cabovisao 2m- 2012	OMT 12m- 2012	ONI 12m- 2012	Ma Ch Sport 2012
(in € millions)						
Revenues		1,092.4	19.8	195.1	117.4	15.0
Purchases and subcontracting services		(302.1)	(8.8)	(63.9)	(66.8)	(7.0)
Gross profit		790.3	11.0	131.2	50.6	8.0
Other operating expenses		(248.9)	(4.6)	(41.2)	(21.1)	(2.0)
Other sales and marketing expenses		(80.1)	(2.4)	(17.0)	(2.6)	(.0)
General and administrative expenses		(58.1)	(1.4)	(9.9)	(13.1)	(2.0)
Operating income before depreciation & amortization		403.2	2.6	63.1	13.8	2.0
Capital expenditures		347.0	2.8	28.3	12.7	7.0

For the year ended December 31, 2011		Altice VII S.à r.l.	Hot 3m- 2011	Coditel Bel-7m- 2011	Coditel Lux-7m- 2011	Cabovisao 12m- 2011	OMT 12m- 2011	ONI 12m- 2011
(in € millions)								
Revenues		784.2	165.1	28.2	9.5	123.4	194.3	115.0
Purchases and subcontracting services		(175.4)	(48.0)	(4.5)	(1.7)	(54.7)	(64.7)	(58.0)
Gross profit		608.8	117.1	23.7	7.8	68.7	129.6	56.0
Other operating expenses		(195.4)	(38.6)	(2.9)	(.6)	(20.7)	(39.7)	(21.0)
Other sales and marketing expenses		(64.4)	(9.8)	(1.3)	(.3)	(12.8)	(17.3)	(2.0)
General and administrative expenses		(51.2)	(5.4)	(1.6)	(.7)	(17.7)	(11.9)	(11.0)
Operating income before depreciation & amortization		297.8	63.3	18.0	6.2	17.5	60.7	21.0
Capital expenditures		189.8	23.8	4.0	.9	19.4	36.0	15.0

(b) Revenue

The revenue account balance per segments is as follows:

	Total Israel	Total BeLux	Oni	Cabovisao S.A.	Cabovisao S.A. (Altice VII)	Total Portugal	French Overseas Territories (Altice VII)
	Jan 1, 2012 to Dec 31, 2012	Jan 1, 2012 to Dec 31, 2012	Jan 1, 2012 to Dec 31, 2012	Jan 1, 2012 to Feb 29, 2012	Mar 1, 2012 to Dec 31, 2012	Jan 1, 2012 to Dec 31, 2012	Jan 1, 2012 to Dec 31, 2012
	EUR	EUR	EUR	EUR	EUR	EUR	EUR
For the year ended December 31, 2012							
Cable based services	677.9	59.7	—	19.8	98.2	118.0	24.4
Mobile services	172.5	.2	—	—	—	—	—
B2B Others	—	11.5	117.4	—	—	117.4	—
Total	850.4	71.3	117.4	19.8	98.2	235.4	24.4
	Total Israel	Total BeLux	Oni	Cabovisao S.A.	Total Portugal	French Overseas Territories (Altice VII)	
	Jan 1, 2011 to Dec 31, 2011	Jan 1, 2011 to Dec 31, 2011	Jan 1, 2011 to Dec 31, 2011	Jan 1, 2011 to Dec 31, 2011	Jan 1, 2011 to Dec 31, 2011	Jan 1, 2011 to Dec 31, 2011	
	EUR	EUR	EUR	EUR	EUR	EUR	
For the year ended, December 31, 2011							
Cable based services	664.9	58.5	—	123.4	123.4	23.6	
Mobile services	180.6	—	—	—	—	—	
B2B Others	—	8.8	115.4	—	115.4	—	
Total	845.5	67.3	115.4	123.4	238.8	23.6	

(c) Gross profit

The gross profit per segments is as follows:

	Total Israel	Total BeLux	Oni	Cabovisao S.A.	Cabovisao S.A. (Altice VII)	Total Portugal	French Overseas Territories (Altice VII)
	Jan 1, 2012 to Dec 31, 2012	Jan 1, 2012 to Dec 31, 2012	Jan 1, 2012 to Dec 31, 2012	Jan 1, 2012 to Feb 29, 2012	Mar 1, 2012 to Dec 31, 2012	Jan 1, 2012 to Dec 31, 2012	Jan 1, 2012 to Dec 31, 2012
	EUR	EUR	EUR	EUR	EUR	EUR	EUR
For the year ended December 31, 2012							
Cable based services	518.9	49.6	—	11.0	59.1	70.1	20.4
Mobile services	102.7	.1	—	—	—	—	—
B2B Others	—	10.6	50.6	—	—	50.6	—
Total	621.7	60.3	50.6	11.0	59.1	120.7	20.4
	Total Israel	Total BeLux	Oni	Cabovisao S.A.	Cabovisao S.A. (Altice VII)	Total Portugal	French Overseas Territories (Altice VII)
	Jan 1, 2011 to Dec 31, 2011	Jan 1, 2011 to Dec 31, 2011	Jan 1, 2011 to Dec 31, 2011	Jan 1, 2011 to Dec 31, 2011	Jan 1, 2011 to Dec 31, 2011	Jan 1, 2011 to Dec 31, 2011	Jan 1, 2011 to Dec 31, 2011
	EUR	EUR	EUR	EUR	EUR	EUR	EUR
For the year ended December 31, 2011							
Cable based services	510.5	46.8	—	—	68.7	68.7	19.8
Mobile services	149.7	—	—	—	—	—	—
B2B Others	—	7.8	56.6	—	—	56.6	—
Total	660.2	54.7	56.6	56.6	68.7	125.3	19.8

(d) Operating expenses

	Total Israel	Total BeLux	Oni	Cabovisao S.A.	Cabovisao S.A. (Altice VII)	Total Portugal	French Overseas Territories (Altice VII)
	Jan 1, 2012 to Dec 31, 2012	Jan 1, 2012 to Dec 31, 2012	Jan 1, 2012 to Dec 31, 2012	Jan 1, 2012 to Feb 29, 2012	Mar 1, 2012 to Dec 31, 2012	Jan 1, 2012 to Dec 31, 2012	Jan 1, 2012 to Dec 31, 2012
	EUR	EUR	EUR	EUR	EUR	EUR	EUR
For the year ended December 31, 2012							
Other operating expenses	(223.4)	(6.2)	(21.1)	(4.6)	(8.0)	(38.3)	(3.8)
Other sales and marketing expenses	(63.7)	(4.4)	(2.6)	(2.4)	(8.7)	(12.6)	(2.5)
General and administrative expenses	(29.3)	(4.1)	(13.1)	(1.4)	(10.8)	(21.8)	(2.0)
Total	(316.5)	(14.7)	(36.8)	(8.4)	(29.2)	(72.7)	(8.3)
	Total Israel	Total BeLux	Oni	Cabovisao S.A.	Cabovisao S.A. (Altice VII)	Total Portugal	French Overseas Territories (Altice VII)
	Jan 1, 2011 to Dec 31, 2011	Jan 1, 2011 to Dec 31, 2011	Jan 1, 2011 to Dec 31, 2011	Jan 1, 2011 to Dec 31, 2011	Jan 1, 2011 to Dec 31, 2011	Jan 1, 2011 to Dec 31, 2011	Jan 1, 2011 to Dec 31, 2011
	EUR	EUR	EUR	EUR	EUR	EUR	EUR
For the year ended December 31, 2011							
Other operating expenses	(225.8)	(6.4)	(21.0)	(20.7)	(41.7)	(3.9)	
Other sales and marketing expenses	(67.5)	(3.4)	(2.9)	(12.8)	(15.7)	(2.7)	
General and administrative expenses	(39.7)	(3.9)	(11.1)	(17.7)	(28.8)	(1.6)	
Total	(333.0)	(13.7)	(35.0)	(51.2)	(86.3)	(8.1)	

(e) Operating income before depreciation & amortisation

	Total Israel	Total BeLux	Oni	Cabovisao S.A.	Cabovisao S.A.	Total Portugal	French Overseas Territories (Altice VII)
	Jan 1, 2012 to Dec 31, 2012	Jan 1, 2012 to Dec 31, 2012	Jan 1, 2012 to Dec 31, 2012	Jan 1, 2012 to Feb 29, 2012	Mar 1, 2012 to Dec 31, 2012	Jan 1, 2012 to Dec 31, 2012	Jan 1, 2012 to Dec 31, 2012
	EUR	EUR	EUR	EUR	EUR	EUR	EUR
For the year ended December 31, 2012							
Operating income before depreciation & amortisation	305.2	45.6	13.8	2.6	31.6	48.0	12.1
	Total Israel	Total BeLux	Oni	Cabovisao S.A.	Total Portugal	French Overseas Territories (Altice VII)	
	Jan 1, 2011 to Dec 31, 2011	Jan 1, 2011 to Dec 31, 2011	Jan 1, 2011 to Dec 31, 2011	Jan 1, 2011 to Dec 31, 2011	Jan 1, 2011 to Dec 31, 2011	Jan 1, 2011 to Dec 31, 2011	
	EUR	EUR	EUR	EUR	EUR	EUR	
For the year ended December 31, 2011							
Operating income before depreciation & amortisation	327.2	41.0	21.5	17.5	39.0	11.7	

(f) Capital Expenditures

	Israel	BeLux	Oni	Cabovisao S.A.	Cabovisao S.A. (Altice VII)	Portugal	French Overseas Territories (Altice VII)
	Jan 1, 2012 to Dec 31, 2012	Jan 1, 2012 to Dec 31, 2012	Jan 1, 2012 to Dec 31, 2012	Jan 1, 2012 to Feb 29, 2012	Mar 1, 2012 to Dec 31, 2012	Jan 1, 2012 to Dec 31, 2012	Jan 1, 2012 to Dec 31, 2012
For the year ended December 31, 2012	EUR	EUR	EUR	EUR	EUR	EUR	EUR
Cable	211.6	17.0	—	2.8	15.3	18.1	7.4
Mobile	83.8	—	—	—	—	—	—
B2B/Other	—	—	12.7	—	—	12.7	—
Total	295.4	17.0	12.7	2.8	15.3	30.8	7.4
	Israel	BeLux	Oni	Cabovisao S.A.	Cabovisao S.A. (Altice VII)	Portugal	French Overseas Territories (Altice VII)
	Jan 1, 2011 to Dec 31, 2011	Jan 1, 2011 to Dec 31, 2011	Jan 1, 2011 to Dec 31, 2011	Jan 1, 2011 to Dec 31, 2011	Jan 1, 2011 to Dec 31, 2011	Jan 1, 2011 to Dec 31, 2011	Jan 1, 2011 to Dec 31, 2011
For the year ended December 31, 2011	EUR	EUR	EUR	EUR	EUR	EUR	EUR
Cable	126.8	10.6	—	—	19.4	19.4	17.5
Mobile	47.1	—	—	—	—	—	—
B2B/Other	—	—	15.0	—	—	15.0	—
Total	173.9	10.6	15.0	15.0	19.4	34.4	17.5

ORANGE DOMINICANA, S.A.

**Unaudited Condensed interim standalone Financial Statements
As of September 30, 2013 and for the nine-month periods ended
September 30, 2013 and 2012**

INDEPENDENT AUDITORS' REVIEW REPORT

To the Board of Directors and Shareholders of Orange Dominicana

We have reviewed the accompanying condensed statement of financial position of Orange Dominicana (the "Company") as of September 30, 2013, and the related condensed statements of income, shareholders' equity and of cash flows for the nine-month periods ended September 30, 2013 and 2012 (the "interim financial statements"). These interim financial statements are the responsibility of the Company's management.

We conducted our review in accordance with auditing standards generally accepted in the United States of America ("US GAAS") applicable to reviews of interim financial statements. A review of interim financial statements consists principally of applying analytical procedures and making inquiries of persons responsible for financial and accounting matters. It is substantially less in scope than an audit conducted in accordance with US GAAS, the objective of which is the expression of an opinion regarding the financial statements taken as a whole. Accordingly, we do not express such an opinion.

Based on our review, we are not aware of any material modifications that should be made to such interim financial statements for them to be in conformity with International Financial Reporting Standards as issued by the IASB.

DELOITTE & ASSOCIÉS

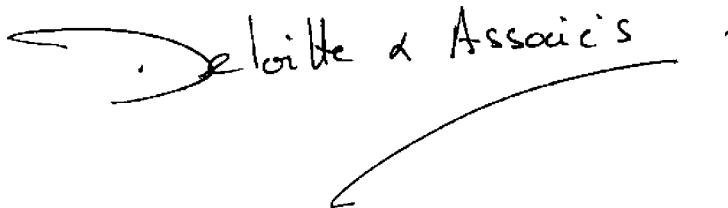
A handwritten signature in black ink that reads "Deloitte & Associés". The signature is written in a cursive style and is underlined with a long, sweeping line that extends to the right and then curves back down to the left.

Neuilly-sur-Seine, France

November 8, 2013

ORANGE DOMINICANA, S.A.
Unaudited Condensed interim standalone Financial Statements
Table of Contents

	<u>Page</u>
Interim Income statement	F-221
Interim Statement of financial position	F-222
Interim Statement of cash flows	F-223
Statements of changes in equity	F-224
Notes to the financial statements	F-225

UNAUDITED INTERIM INCOME STATEMENT

<u>Income statement</u>	<u>Notes</u>	<u>30 September 2013</u>	<u>30 September 2012</u>
		In Dominican pesos	
Revenues	2.1	17,953,623,352	16,943,056,706
Cost of equipment sold	3.1	(2,233,113,679)	(2,142,869,777)
Selling, distribution and traffic costs	3.2	(4,634,645,907)	(4,397,888,405)
Advertising and sponsoring costs		(558,839,468)	(694,526,326)
Offices and technical sites costs		(460,915,458)	(420,459,308)
Labor expenses		(913,106,344)	(880,444,330)
Corporate fees		(463,576,479)	(424,899,623)
Maintenance costs		(237,235,126)	(240,420,765)
Other costs and income	3.3	(1,758,774,800)	(1,862,560,142)
Depreciation and amortization		(2,565,020,605)	(2,544,776,512)
Total costs and operating expenses		<u>(13,825,227,867)</u>	<u>(13,608,845,188)</u>
Operating income		4,128,395,485	3,334,211,519
Bank commissions		(56,524,122)	(53,030,486)
Interest income		10,772,788	28,710,113
Foreign currency exchange gains (losses)		16,451,647	27,756,910
Other		(12,833,299)	(11,290,289)
Non-operating income (expenses)		<u>(42,132,986)</u>	<u>(7,853,751)</u>
Profit before income tax		4,086,262,499	3,326,357,767
Income tax	5.1	(1,157,726,258)	(678,075,213)
Net income		<u>2,928,536,241</u>	<u>2,648,282,554</u>
Other comprehensive income		—	—
Total comprehensive income for the period		<u><u>2,928,536,241</u></u>	<u><u>2,648,282,554</u></u>

UNAUDITED INTERIM STATEMENT OF FINANCIAL POSITION

<u>Statement of financial position</u>	<u>Notes</u>	<u>30 September 2013</u>	<u>31 December 2012</u>
		In Dominican pesos	
Intangible assets, net		2,083,854,439	2,211,688,949
Property, plant and equipment, net		13,582,224,499	13,873,521,204
Other non-current assets		54,553,673	55,133,105
Deferred tax assets	5.4	1,689,177,934	1,622,149,160
Total non-current assets		17,409,810,545	17,762,492,418
Inventories		749,343,236	882,961,123
Trade receivables	2.2	2,798,086,600	2,570,781,717
Other receivables	2.3	1,658,008,675	629,454,718
Income tax receivable	5.2	—	235,499,637
Prepaid expenses		380,664,144	197,925,846
Cash and cash equivalents		1,195,762,606	1,159,590,768
Total current assets		6,781,865,261	5,676,213,809
Total assets		24,191,675,806	23,438,706,227
Share capital		5,800,000,000	5,800,000,000
Legal reserve		580,000,000	580,000,000
Hyperinflation reserve		1,680,984,200	1,680,984,200
Retained earnings		9,268,872,610	8,182,305,384
Total Shareholders' equity	6	17,329,856,810	16,243,289,584
Non-current liabilities	4	675,411,098	644,675,778
Total non-current liabilities		675,411,098	644,675,778
Trade payables	3.4	3,654,539,431	4,138,024,612
Other current liabilities	3.5	639,704,539	697,728,614
Deferred income	2.4	1,621,475,503	1,714,987,638
Income tax payable	5.2	270,688,424	—
Total current liabilities		6,186,407,898	6,550,740,864
Total equity and liabilities		24,191,675,806	23,438,706,227

UNAUDITED INTERIM STATEMENT OF CASH FLOWS

<u>Statement of cash flows</u>	<u>30 September 2013</u>	<u>31 December 2012</u>
	In Dominican pesos	
Operating activities		
Net income	2,928,536,241	2,648,282,554
<i>Adjustments to reconcile net profit to cash provided by operating activities</i>		
Depreciation and amortization	2,565,020,605	2,544,776,512
Gains (losses) on disposal	—	761,266
Change in provisions (Litigations, dismantling and others)	(46,242,738)	5,697,755
Income tax	(67,028,774)	(315,110,931)
<i>Change in inventories, accounts receivable and payable</i>		
Decrease (increase) in inventories, net	133,617,887	183,581,099
Decrease (increase) in trade receivables, net	(227,304,883)	(57,402,854)
Decrease (increase) in other receivables, net	(1,028,553,957)	(1,708,378,628)
Increase (decrease) in trade payables	(470,104,195)	(1,282,314,308)
<i>Other changes in working capital requirements</i>		
Decrease (increase) in prepaid expenses	(182,738,298)	(17,071,152)
Decrease (increase) in other non-current assets	579,432	(841,696)
Decrease (increase) in other non-current liabilities	23,766,156	11,704,639
Decrease (increase) in other current liabilities	(58,024,074)	213,905,373
Deferred income	(93,512,135)	(111,407,413)
Change in income tax receivable/payable	506,188,061	558,593,269
Net cash provided by operating activities	3,984,199,326	2,674,775,484
Investing activities		
Purchase of PPE and intangible assets	(2,092,677,488)	(1,928,169,285)
Net cash used in investing activities	(2,092,677,488)	(1,928,169,285)
Financing activities		
Dividends paid	(1,855,350,000)	(1,137,080,000)
Net cash used in financing activities	(1,855,350,000)	(1,137,080,000)
Net increase (decrease) in cash and cash equivalents	36,171,837	(390,473,802)
Cash and cash equivalents—opening balance	1,159,590,768	1,144,656,534
Cash and cash equivalents—closing balance	1,195,762,606	754,182,731

UNAUDITED STATEMENT OF CHANGE IN EQUITY

Statement of changes in equity	Capital	Legal Reserve	Hyperinflation reserve In Dominican pesos	Retained Earnings	Total
Balance at 12/31/2012 .	5,800,000,000	580,000,000	1,680,984,200	8,182,305,384	16,243,289,584
Net income	—	—	—	2,928,536,241	2,928,536,241
Other comprehensive income	—	—	—	—	—
Total comprehensive income	—	—	—	—	—
Dividends paid (note 9.3)	—	—	—	(1,855,350,000)	(1,855,350,000)
Other movement	—	—	—	13,380,986	13,380,986
Capital increase	—	—	—	—	—
Balance at 09/30/2013 .	5,800,000,000	580,000,000	1,680,984,200	9,268,872,610	17,329,856,810

Notes to the unaudited condensed interim standalone financial statements

Note 1—Basis of preparation of the condensed interim standalone financial statements

This note describes the changes in accounting policies which were used by Orange Dominicana S.A. (hereafter called “ODO”) to prepare its condensed interim financial statements as of September 30, 2013 and for the nine-month periods ended September 30, 2013 and 2012 (the “Interim Financial Statements”). The financial statements as of December 31, 2012 and 2011 and for the two years then ended were audited by Deloitte & Associés and signed off on September 18, 2013 (the Financial Statements).

1.1 Basis of presentation and purpose of the financial statements

The condensed financial statements and notes were prepared for the purpose of the disposal of ODO by the Orange Group.

The Interim Financial Statements were prepared in accordance with IAS 34 “Interim Financial Reporting”, as issued by the IASB.

The Interim Financial Statements were prepared using the same accounting policies as the Financial Statements, with the exception of the specific requirements of IAS 34 and the application of the new standards presented in note 1.4.

Where a specific transaction is not dealt with any standard or interpretation, management uses its judgment to define and apply an accounting policy that will result in relevant and reliable information, such that the financial statements:

- present fairly ODO’s financial position, financial performance and cash flows;
- reflect the economic substance of the transactions;
- are neutral;
- are prepared on a prudent basis; and
- are complete in all material respects.

1.2 Uses of estimates and judgment

In preparing ODO’s financial statements, ODO’s management is required to make estimates insofar as many elements included in the financial statements cannot be measured with precision. The underlying assumptions used for the main estimates are similar to those described in the Financial Statements. The management revises these estimates if the underlying circumstances evolve or in light of new information or experience. Consequently, estimates made at September 30, 2013 may subsequently be changed. ODO’s management also uses its judgment to define appropriate accounting policies to apply to certain transactions when the current IFRS standards and interpretations do not specifically deal with related accounting issues.

1.3 New standards and interpretations

- Standard applied from January 1, 2013

Standard		Consequences for ODO
IFRS 13	Fair Value Measurement	This standard is applicable prospectively and has no effect on the fair value currently measured by ODO: The requirements provided by the standard have no effect on the measurements of the fair value of the Company’s financial assets and liabilities.

Notes to the unaudited condensed interim standalone financial statements (Continued)

Note 1—Basis of preparation of the condensed interim standalone financial statements (Continued)

- Interpretation issued but not earlier applied

Standard	Consequences for ODO
IFRIC 21 Levies	<p>The principal issue raised by this interpretation is about when an entity should recognise a liability to pay a levy imposed by government (other than income taxes).</p> <p>The application of this interpretation might impact the interim net income and its effects are currently being analyzed by ODO.</p> <p>This interpretation is applicable retrospectively from January 1, 2014.</p>

Note 2—Sales

2.1 Revenues

Revenues	30 September 2013	30 September 2012
	In thousand Dominican pesos	
Mobile	15,142,964	14,553,765
Wholesale	1,365,315	1,236,343
Internet	459,201	374,726
Equipment	771,756	591,411
Other	214,387	186,812
Revenues	<u>17,953,623</u>	<u>16,943,057</u>

2.2 Trade receivables

Trade receivables	30 September 2013	31 December 2012
	In Dominican pesos	
Customers (gross)	3,266,636,847	3,058,316,537
Provision for doubtful accounts	(468,550,247)	(487,534,820)
Customers (net of provision)	<u>2,798,086,600</u>	<u>2,570,781,717</u>

2.3 Other receivables

Other receivables	30 September 2013	31 December 2012
	In Dominican pesos	
Advances to suppliers	185,844,522	296,156,659
VAT	136,103,685	158,393,560
Cash pooling—current account	1,320,953,268	135,623,414
Others	15,107,200	39,281,085
Total	<u>1,658,008,675</u>	<u>629,454,718</u>

Notes to the unaudited condensed interim standalone financial statements (Continued)

Note 2—Sales (Continued)

2.4 Deferred income

<u>Deferred income</u>	<u>30 September 2013</u>	<u>31 December 2012</u>
	In Dominican pesos	
Prepaid telephone cards	898,858,666	768,069,643
Loyalty program	511,072,839	511,072,839
Monthly fee	114,583,592	130,045,686
Handsets	89,708,698	237,384,310
Sim & Kit and other deferred income	7,251,708	68,415,159
Total	<u>1,621,475,503</u>	<u>1,714,987,638</u>

Note 3—Purchases and other expenses

3.1 Cost of equipment sold

The costs of equipment sold comprise purchases of handsets and other Sim and phone cards, as well as all costs directly attributable to them (mainly import duties and freight charges).

<u>Cost of equipment sold</u>	<u>30 September 2013</u>	<u>30 September 2012</u>
	In Dominican pesos	
Handsets	2,016,771,981	1,920,113,769
SIM cards	84,803,957	99,664,291
Import duties and freight costs	95,389,394	85,955,075
Other (phone cards, accessories)	36,148,347	37,136,642
Total	<u>2,233,113,679</u>	<u>2,142,869,777</u>

3.2 Selling, distribution and traffic costs

<u>Selling, distribution and traffic costs</u>	<u>30 September 2013</u>	<u>30 September 2012</u>
	In Dominican pesos	
Selling and distribution costs	1,655,106,345	1,659,834,246
National voice mobile terminations	1,340,220,824	1,342,292,409
National voice fixed line terminations	129,579,046	145,237,567
International terminations	372,397,291	366,537,604
Data terminations (SMS)	175,845,298	176,539,347
International roaming	59,495,541	57,510,340
LDB	841,620,155	602,020,596
Other	60,381,407	47,916,298
Total	<u>4,634,645,907</u>	<u>4,397,888,405</u>

Notes to the unaudited condensed interim standalone financial statements (Continued)

Note 3—Purchases and other expenses (Continued)

3.3 Others

<u>Other costs and income</u>	<u>30 September 2013</u>	<u>30 September 2012</u>
	In Dominican pesos	
Disposal of fixed assets	1,210,715	4,478,401
Cost recovery	2,816,613	6,330,051
Other operating income	144,644,683	95,941,218
Other income	148,672,011	106,749,670
Purchase of services	(349,875,305)	(327,533,002)
Electricity	(166,434,360)	(147,669,887)
Gas	(210,472,642)	(174,103,954)
Network energy	(376,907,002)	(321,773,841)
Consulting, contractors & prof. serv.	(189,576,002)	(228,709,264)
Bad debt expense	(163,196,881)	(149,045,074)
IT expenses	(129,538,136)	(131,518,941)
Temporary staff/interim net ^(a)	(55,059,865)	(58,282,361)
Purchases of supplies	(99,737,121)	(101,767,006)
Operating tax	(36,813,171)	(119,244,964)
Security	(67,814,720)	(66,430,751)
Spectrum fees	(63,744,900)	(56,462,353)
Storage costs	(55,541,061)	(50,346,727)
Travels	(18,917,142)	(27,762,142)
Other operating provision	30,133,591	24,434,113
Other	(330,859,095)	(354,867,500)
Other	(506,743,327)	(531,435,360)
Total	<u>(1,758,774,800)</u>	<u>(1,862,560,142)</u>

(a) The temporary labor expenses attributable to the network development are net of costs capitalized.

3.4 Trade payables

<u>Trade payables</u>	<u>30 September 2013</u>	<u>31 December 2012</u>
	In Dominican pesos	
Fixed assets and operating suppliers	2,590,346,613	3,044,652,663
Related companies	368,786,370	314,449,212
Distributors (dealers)	207,869,622	229,265,172
Merchandises suppliers	445,068,152	540,481,470
Others	42,468,675	9,176,095
Total	<u>3,654,539,431</u>	<u>4,138,024,612</u>

3.5 Other current liabilities

<u>Other current liabilities</u>	<u>30 September 2013</u>	<u>31 December 2012</u>
	In Dominican pesos	
Taxes and VAT	377,696,434	455,803,544
Staff bonuses	155,458,438	213,293,577
Vacations and other	106,549,667	28,631,492
Total	<u>639,704,539</u>	<u>697,728,614</u>

Notes to the unaudited condensed interim standalone financial statements (Continued)

Note 3—Purchases and other expenses (Continued)

3.6 Intangible assets, property, plant and equipment

Intangible assets	September 2013					2012
	Frequencies	Software licenses & IRU	Right of use corporate solutions	Total		
	In Dominican pesos					
Gross value (opening balance)	1,192,676,947	4,094,656,073	132,852,964	5,420,185,983	4,782,110,363	
Acquisitions	—	322,654,772	17,796,570	340,451,342	696,046,488	
Disposals	—	(9,204,595)	—	(9,204,595)	(14,352,199)	
Reallocations	(1,213,414)	(81,669,305)	—	(82,882,719)	(43,618,668)	
Gross value (closing balance)	1,191,463,533	4,326,436,945	150,649,534	5,668,550,011	5,420,185,983	
Depreciation (opening balance)	(593,324,201)	(2,525,276,116)	(89,896,717)	(3,208,497,034)	(2,534,475,883)	
Depreciation expense	(94,331,958)	(388,527,353)	(15,416,067)	(498,275,378)	(688,373,350)	
Disposals	—	9,204,595	—	9,204,595	14,352,199	
Reallocation	1,213,414	111,658,831	—	112,872,245	—	
Depreciation (closing balance)	(686,442,745)	(2,792,940,043)	(105,312,784)	(3,584,695,572)	(3,208,497,035)	
Net total value	505,020,788	1,533,496,902	45,336,750	2,083,854,439	2,211,688,949	

For the period ended September 30, 2013, the reallocations mainly comprise a reclassification between gross value and depreciation due to hyperinflation effect for an amount of MDOP 70.

Plant, property and equipment	September 2013						2012
	Lands	Buildings	Network and transition equipment	IT infrastructure	Others	Total	
	In Dominican pesos						
Gross value (opening balance)	158,783,979	1,720,670,474	25,760,775,864	2,159,692,072	188,739,491	29,988,661,879	27,229,194,068
Acquisitions	—	108,198,102	1,416,882,031	217,768,184	9,377,828	1,752,226,145	2,941,068,823
Disposals	—	—	(7,195,915)	(4,462,842)	(12,556)	(11,671,313)	(91,446,590)
Reallocations	17,803,154	(88,563,081)	(1,197,562,201)	(122,953,656)	(3,800,390)	(1,395,076,174)	(90,154,421)
Gross value (closing balance)	176,587,133	1,740,305,495	25,972,899,780	2,250,043,758	194,304,373	30,334,140,538	29,988,661,879
Depreciation (opening balance)	—	(814,069,448)	(13,670,410,515)	(1,529,631,424)	(101,029,288)	(16,115,140,675)	(13,384,994,371)
Depreciation expense	—	(157,040,625)	(1,708,852,847)	(189,288,219)	(11,563,537)	(2,066,745,228)	(2,820,831,628)
Disposals	—	—	7,195,915	4,462,842	12,556	11,671,313	90,685,324
Reallocation	—	70,811,451	1,220,784,576	122,953,656	3,748,865	1,418,298,548	—
Depreciation (closing balance)	—	(900,298,622)	(14,151,282,871)	(1,591,503,145)	(108,831,404)	(16,751,916,042)	(16,115,140,675)
Net total value	176,587,133	840,006,873	11,821,616,909	658,540,613	85,472,969	13,582,224,497	13,873,521,205

For the period ended September 30, 2013, the reallocations mainly comprise a reclassification between gross value and depreciation due to hyperinflation effect for an amount of MDOP 1,461.

Note 4—Non-current liabilities

Non-current liabilities	30 September 2013	31 December 2012
	In Dominican pesos	
Customer deposit	214,017,203	203,084,345
Provisions	301,104,336	343,923,698
ARO provisions	160,289,559	97,667,735
Total	675,411,098	644,675,778

Notes to the unaudited condensed interim standalone financial statements (Continued)

Note 5—Income tax

The computation of the income tax for these Interim Financial Statements is similar the one used for the Financial Statements.

5.1 Income tax charge

<u>Income tax</u>	<u>30 September 2013</u>	<u>30 September 2012</u>
	In Dominican pesos	
Current income tax	1,248,913,501	1,103,276,284
Deferred income tax	(67,028,773)	(278,722,960)
Dividends credits	—	(136,102,753)
Tax credit from Law 57-2007 incentives	(24,158,469)	(10,375,358)
Total	<u>1,157,726,259</u>	<u>678,075,214</u>

5.2 Income tax receivable/liability

<u>Income tax</u>	<u>30 September 2013</u>	<u>31 December 2012</u>
	In Dominican pesos	
Advances of the period	681,466,294	497,442,249
Prior year tax credit carry forward	272,600,314	796,762,816
Tax credit from Law 57-2007 incentives	24,158,469	10,387,949
Credit arising from dividends withholdings	—	329,753,087
Current tax provision	(1,248,913,501)	(1,398,846,464)
Total	<u>(270,688,424)</u>	<u>235,499,637</u>

5.3 Tax proof

<u>Tax proof</u>	<u>30 September 2013</u>	<u>30 September 2012</u>
	In Dominican pesos	
Profit before income tax	4,086,262,499	3,326,357,767
29% Income tax rate on profit before income tax	1,185,016,125	964,643,752
Tax effect of:		
Dividends credits	—	(136,102,753)
Impact of assets annual reevaluation for tax purpose (inflation)	(128,930,555)	(219,374,058)
Effect of change in tax rate on deferred income tax	(15,965,873)	—
Adjustment to current tax of prior year	(9,418,271)	27,326,457
Other	127,024,833	41,581,815
Effective income tax	<u>1,157,726,259</u>	<u>678,075,213</u>
Effective tax rate	28.3%	20.4%

Notes to the unaudited condensed interim standalone financial statements (Continued)

Note 5—Income tax (Continued)

5.4 Deferred income tax

Deferred income tax	30 September 2013		31 December 2012	
	Balance Sheet	Income Statement	Balance Sheet	Income Statement
	In Dominican pesos			
Provision for loyalty Program	127,351,697	10,637,970	137,989,667	15,151,457
Depreciable fixed assets	1,169,040,910	(68,145,177)	1,100,895,733	(257,394,884)
Provision for bad debts	133,391,795	14,442,118	147,833,913	(14,097,955)
Provision inventory obsolescence . .	26,712,489	(4,911,040)	21,801,449	(774,224)
Other provisions	324,773,833	561,173	325,335,006	(77,268,838)
Vacations and incentives provision .	8,945,746	765,535	9,711,281	1,119,279
Deferred revenues/cost	1,813,896	64,782	1,878,678	(10,349,938)
Exchange difference	—	—	—	1,554,733
Deferred tax assets	1,792,030,365	(46,584,638)	1,745,445,727	(342,060,370)
Deferred tax liabilities				
Exchange difference	(5,315,111)	4,347,991	(967,120)	—
Effect of IAS 29 adjustment	(97,537,320)	(24,792,127)	(122,329,447)	9,559,672
Deferred tax liabilities	(102,852,431)	(20,444,135)	(123,296,566)	9,559,671
Net deferred tax	1,689,177,934	(67,028,773)	1,622,149,161	(332,500,699)

Note 6—Equity

6.1 Share capital

At September 30, 2013, based on the number of issued shares at that date, ODO's share capital amounted to RD\$5,800,000,000, comprising 58,000,000 shares with a par value of RD\$100 each.

6.2 Legal reserve

In accordance with the article 58 of the commercial Code of the Dominican Republic, the legal reserve is annually contributed by 5% of the net income until the total amount equals 10% of paid-in capital. This reserve cannot be capitalized, transferred to retained earnings or to be used to pay dividends.

6.3 Dividends

ODO's shareholders meeting approved the payment of dividends in May 2013 for a total amount of RD\$1,855,350,000.

The Tax Reform Act, No. 253-12, enacted on November 9, 2012 establishes a 10% withholding tax on dividends due by the distributing entity (accounted for as a reduction of equity in accordance with IAS 12—Income Tax). This new act supersedes the prior regime that consisted in a 29% withholding tax on dividends, which was subsequently refunded as a tax credit to the distributing entity, in the same fiscal period.

Note 7—Litigation and unrecognized contractual commitments

7.1 Litigation

As of September 30, 2013, ODO is party to certain judicial procedures with former distributors or dealers, for which no provision is recorded as ODO considers at this stage of the procedure that the claims are without merit.

No significant litigation has occurred since December 31, 2012.

7.2 Unrecognized contractual commitments

No event has significantly impacted the unrecognized contractual commitments since December 31, 2012.

Note 8—Subsequent events

None.

ORANGE DOMINICANA, S.A.
Standalone Financial Statements
As of and for the two years ended December 31, 2013

INDEPENDENT AUDITORS' REPORT

To the Board of Directors and Stockholders of Orange Dominicana

We have audited the accompanying balance sheets of Orange Dominicana (the "Company") as of December 31, 2013 and 2012, and the related statements of income, stockholders' equity, and cash flows for the years then ended. These financial statements are the responsibility of the Company's management. Our responsibility is to express an opinion on these financial statements based on our audits.

We conducted our audits in accordance with auditing standards generally accepted in the United States of America. Those standards require that we plan and perform the audit to obtain reasonable assurance about whether the financial statements are free of material misstatement. An audit includes consideration of internal control over financial reporting as a basis for designing audit procedures that are appropriate in the circumstances, but not for the purpose of expressing an opinion on the effectiveness of the Company's internal control over financial reporting. Accordingly, we express no such opinion. An audit also includes examining, on a test basis, evidence supporting the amounts and disclosures in the financial statements, assessing the accounting principles used and significant estimates made by management, as well as evaluating the overall financial statement presentation. We believe that our audits provide a reasonable basis for our opinion.

In our opinion, such financial statements present fairly, in all material respects, the financial position of the Company as of December 31, 2013 and 2012, and the results of its operations and its cash flows for the years then ended in conformity with International Financial Reporting Standards ("IFRS") as issued by the IASB.

DELOITTE & ASSOCIÉS

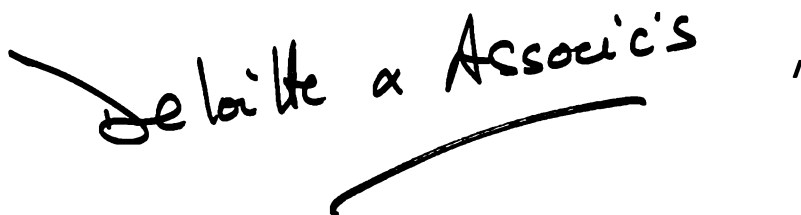
A handwritten signature in black ink that reads "Deloitte & Associés". The signature is written in a cursive, slightly slanted style. A long horizontal line is drawn underneath the signature, starting from the left and extending towards the right, ending under the word "Associés".

Neuilly-sur-Seine, France
March 7, 2014

Société anonyme au capital de 1 723 040 €
Société d'Expertise Comptable inscrite au Tableau de l'Ordre du Conseil Régional de Paris Ile-de France
Société de Commissaires aux Comptes membre de la Compagnie régionale de Versailles
572 028 041 RCS Nanterre
TVA FR 02 572 028 041

Member of Deloitte Touche Tohmatsu Limited

ORANGE DOMINICANA, S. A.
Financial Statements
December 31, 2013

ORANGE DOMINICANA, S. A.

Financial Statements

Content

Income Statements	F-236
Statement of Financial Position	F-237
Statements of Cash Flows	F-238
Statements of Changes in Equity	F-239
Notes to the Financial Statements	F-240

Orange Dominicana, S. A.
Income Statement
Years ended December 31, 2013 and 2012
(Amounts expressed in Dominican pesos-RD\$)

	<u>2013</u>	<u>2012</u>
Revenues (note 4)	24,404,724,867	22,754,373,505
Cost and operating expenses:		
Cost of equipment sold (note 8)	(3,258,891,193)	(3,000,109,167)
Selling, distribution and traffic costs (note 9)	(6,262,609,226)	(5,861,191,549)
Advertising and sponsoring costs	(875,449,137)	(937,385,613)
Offices and technical sites costs	(623,094,846)	(563,689,755)
Labor expenses (note 14)	(1,233,892,484)	(1,174,728,970)
Corporate fees	(628,491,262)	(582,695,613)
Maintenance costs	(328,775,415)	(331,814,892)
Other costs and income (note 10)	(2,343,587,573)	(2,572,513,250)
Depreciation and amortization (notes 15 and 16)	(3,518,263,738)	(3,509,204,978)
Total cost and operational expenses	<u>(19,073,054,874)</u>	<u>(18,533,333,787)</u>
Income from operations	5,331,669,993	4,221,039,717
Non-operating income (expenses)		
Bank commissions	(75,695,527)	(70,778,482)
Interest income	17,884,697	36,522,740
Foreign currency exchange gains (losses)	26,306,025	69,838,887
Other	(13,204,429)	(20,423,571)
	<u>(44,709,234)</u>	<u>15,159,574</u>
Profit before income tax	5,286,960,759	4,236,199,291
Income tax (note 18)	(1,389,934,101)	(789,931,748)
Net income	<u>3,897,026,658</u>	<u>3,446,267,543</u>

The notes (1 to 30) are an integral part of these financial statements.

Orange Dominicana, S. A.
Statement of Financial Position
As of December 31, 2013 and 2012
(Amounts expressed in Dominican pesos-RD\$)

	2013	2012
Non-current assets:		
Intangible assets, net (note 15)	2,113,374,919	2,211,688,949
Property, plant and equipments, net (note 16)	13,689,442,150	13,873,521,204
Other assets	54,734,720	55,133,105
Deferred tax (note 18)	1,806,330,478	1,622,149,160
Total non-current assets	17,663,882,267	17,762,492,418
Current assets:		
Inventories (note 11)	1,034,348,663	882,961,123
Trade receivables (note 5)	1,832,887,111	1,937,408,905
Other receivables (note 6)	2,972,515,059	629,454,718
Income tax receivable (note 18)	—	235,499,637
Prepaid expenses	255,837,525	197,925,846
Cash and cash equivalents (notes 19 and 28)	1,038,925,338	1,159,590,768
Total current assets	7,134,513,696	5,042,840,997
Total assets	24,798,395,963	22,805,333,415
Shareholders' equity (notes 20, 21 and 22):		
Share capital	5,800,000,000	5,800,000,000
Legal reserve	580,000,000	580,000,000
Retained earnings	11,918,347,226	9,863,289,584
Shareholders' equity, net	18,298,347,226	16,243,289,584
Non-current liabilities (note 17)	632,107,351	644,675,778
Current liabilities:		
Trade payables (notes 12, 24 and 28)	3,252,122,915	3,504,651,801
Other current liabilities (note 13)	721,042,519	697,728,614
Deferred income (note 7)	1,597,303,273	1,714,987,638
Income tax payable (note 18)	297,472,679	—
Total current liabilities	5,867,941,386	5,917,368,053
Total liabilities and shareholders' equity	24,798,395,963	22,805,333,415

The notes (1 to 30) are an integral part of these financial statements.

Orange Dominicana, S. A.
Statements of Cash Flows
Years ended December 31, 2013 and 2012
Amounts expressed in Dominican pesos-RD\$)

	2013	2012
Reconciliation of the net income and net cash provided from operating activities:		
Net income	3,897,026,658	3,446,267,543
<i>Adjustments to reconcile net profit with net cash provided by operating activities:</i>		
Depreciation and amortization	3,518,263,738	3,509,204,978
Gains (losses) on disposals	14,420,020	761,266
Change in provisions (litigations, dismantling and others)	(87,395,724)	67,719,013
Deferred income tax, net	(184,181,318)	(332,500,700)
<i>Changes in inventories, account receivables and payables:</i>		
Inventories, net	(151,387,541)	104,653,055
Trade receivables, net	104,521,795	(59,018,416)
Other receivables	(2,343,060,340)	(2,637,465)
Trade payables, net	(239,147,901)	(483,375,373)
<i>Other changes in working capital requirements</i>		
Prepaid expenses	(57,911,680)	25,398,475
Non-current assets	398,385	(2,114,147)
Non-current liabilities	23,145,409	8,419,337
Other current liabilities	23,313,905	47,427,001
Deferred income	(117,684,366)	41,647,217
Income tax payable	532,972,315	624,977,760
Net cash provided by operating activities	4,933,293,355	6,996,829,544
Cash flows from investment activities:		
Purchase of fixed tangible and intangible assets	(3,198,608,785)	(3,637,115,310)
Net cash used in investing activities	(3,198,608,785)	(3,637,115,310)
Cash flows from financing activities		
Dividends paid	(1,855,350,000)	(3,344,780,000)
Net cash used in financing activities	(1,855,350,000)	(3,344,780,000)
Net increase (decrease) in cash and cash equivalents	(120,665,430)	14,934,234
Cash and cash equivalents at the beginning of the year	1,159,590,768	1,144,656,534
Cash and cash equivalents at the end of the year	1,038,925,338	1,159,590,768

The notes (1 to 30) are an integral part of these financial statements.

Orange Dominicana, S. A.
Statements of Changes in Equity
Years ended December 31, 2013 and 2012
(Amounts expressed in Dominican pesos-RD\$)

	Capital	Legal Reserve	Retained Earnings	Total
Balance as of 12/31/2011	1,752,869,800	175,286,980	14,213,645,261	16,141,802,041
Net income	—	—	3,446,267,543	3,446,267,543
Dividends paid (note 22)	—	—	(3,344,780,000)	(3,344,780,000)
Transfer to legal reserve	—	404,713,020	(404,713,020)	—
Capital Increase	4,047,130,200	—	(4,047,130,200)	—
Balance as of 12/31/2012	5,800,000,000	580,000,000	9,863,289,584	16,243,289,584
Net income	—	—	3,897,026,658	3,897,026,658
Dividends paid (note 22)	—	—	(1,855,350,000)	(1,855,350,000)
Others	—	—	13,380,984	13,380,984
Balance as of 12/31/2013	5,800,000,000	580,000,000	11,918,347,226	18,298,347,226

The notes (1 to 30) are an integral part of these financial statements.

Orange Dominicana, S. A.
Notes to the Financial Statements
December 31, 2013 and 2012
(Amounts expressed in Dominican pesos-RD\$)

1—Description of business and basis of preparation of the standalone financial statements

1.1 Description of business

Orange Dominicana, S.A. (hereafter called “ODO”), a Company incorporated in accordance with the Dominican Republic laws, began operations on November 13th, 2000. ODO is an indirectly wholly owned subsidiary of Orange S.A., French listed Company.

ODO operates under a service concession agreement for the operation of telecommunications services.

ODO provides consumers, businesses and other telecommunication operators with a wide range of services including mobile telecommunications, data transmission and other value-added services.

1.2 Basis of presentation and purpose of the financial statements

These financial statements have been prepared in accordance with International Financial Reporting Standards (IFRSs).

The principles applied to prepare financial data are based on:

- All standards and interpretations compulsory as of December 31, 2013;
- The recognition and measurement alternatives allowed by the IFRSs:

<u>Standard</u>	<u>Alternative used</u>
IAS 2 Inventories	Measurement of inventories determined by the weighted average unit cost method.
IAS 16 Property, Plant and Equipment	Measurement at amortized historical cost
IAS 38 Intangible Assets	Measurement at amortized historical cost

- The available exemptions regarding the retrospective application of IFRSs at the transition date (January 1, 2004 for ODO):

<u>Standard</u>	<u>IFRS 1 alternative used</u>
IAS 16 Property, Plant and Equipment	Measurement of property, plant and equipment and intangible assets at historical cost
IAS 38 Intangible Assets	

In the absence of any accounting standard or interpretation, management uses its judgment to define and apply an accounting policy that will result in relevant and reliable information, such that the financial statements:

- Present fairly the ODO’s financial position, financial performance and cash flows;
- Reflect the economic substance of transactions;
- Are neutral;
- Are prepared on a prudent basis; and
- Are complete in all material respects.

1.3 Standards and interpretations compulsory after December 31, 2012 with no early application elected by ODO.

IFRS 13—Fair value measurement—defines fair value, sets out a framework for measuring fair value and requires disclosures about fair value measurements, including the fair value hierarchy already set out in

Orange Dominicana, S. A.
Notes to the Financial Statements (Continued)
December 31, 2013 and 2012
(Amounts expressed in Dominican pesos-RD\$)

1—Description of business and basis of preparation of the standalone financial statements (Continued)

IFRS 7. This standard is applicable prospectively and has no expected effect on the fair value currently measured by ODO.

1.4 Use of estimates and judgment

In preparing ODO's financial statements, the management makes estimates, insofar as many elements included in the financial statements cannot be measured with precision. These estimates are revised if the underlying circumstances evolve or in light of new information or experience. Consequently, estimates made at December 31, 2013 may subsequently be changed.

ODO's management also uses its judgment to define appropriate accounting policies to apply to certain transactions when the current IFRS standards and interpretations do not specifically deal with related accounting issues.

The underlying assumptions used for significant estimates are outlined below:

<u>Estimate</u>	<u>Nature of estimate</u>
Note 2.3 Revenue	<p>Identification of separable components of a bundled offer based on the individual components relative fair value period of straight-line recognition of revenue relating to invoiced service access fees depending on the nature of product and historical contractual relationship.</p> <p>Reporting of revenue on a net versus gross basis (depending on an analysis of the ODO's involvement as either principal or agent).</p>
Note 2.5 Purchases and other expenses	Provision for claims and litigation: assumptions underlying legal assessment and risk measurement.
Note 2.10.2 Property, plant and equipment, intangible assets	Assessment of assets' useful life based on assessment of the technological, legal or economic environments.
Note 2.11 Income tax ISR	Assumptions used for the computation of the income tax charge to be recorded in the financial statements, together with the technical merit of tax positions. Assumptions used for recognition of deferred tax assets arising.

2—Accounting policies

2.1 Financial statements preparation principle

Income statement

Expenses are presented in the income statement based on their nature.

Operating income corresponds to net income before:

- Finance income;
- Finance costs;
- Income tax (current and deferred taxes).

Orange Dominicana, S. A.
Notes to the Financial Statements (Continued)
December 31, 2013 and 2012
(Amounts expressed in Dominican pesos-RD\$)

2—Accounting policies (Continued)

Statement of financial position

Current and non-current items are presented separately in the statement of financial position: assets and liabilities with a term of no more than twelve months are classified as current whereas, assets and liabilities with a term of more than twelve months are classified as non-current.

Statement of cash flows

The statement of cash flows is reported using the indirect method starting with the net income and is broken down into three categories:

- Cash flows arising from operating activities (including finance costs and income taxes);
- Cash flows arising from investing activities (mainly purchase and disposal of intangible and tangible assets);
- Cash flows arising from financing activities (dividends paid).

2.2 Foreign operations

The amounts in financial statements are expressed in Dominican pesos. All of the amounts of assets and liabilities in foreign currency are translated into Dominican pesos, at the rate in effect of the date of the financial statements. Transactions of revenues, expenses and others, occurred during current years are translated at the rate in effect on the date of the transaction. Gain and losses resulting from the differences between exchange rates are included as other income (expenses) in the accompanying income statements.

As of December 31, 2013 and 2012, the exchange rates used to exchange the amounts in foreign currency were RD\$42.78 and RD\$40.25 per US\$1.00, respectively for cash, accounts receivable and accounts payable; Euro rate is RD\$59.52 and RD\$53.78 per €1.00, respectively.

2.3 Revenues

Revenues from ODO's activities are recognized as follows:

2.3.1 Separable components of bundled offers

Certain service offers include two components: an equipment component (e.g. a mobile handset) and a service component (e.g. a talk plan). For the sale of multiple products or services, ODO evaluates all deliverables in the arrangement to determine whether they represent separate units of accounting. A delivered item is considered a separate unit of accounting if (i) it has value to the customer on a standalone basis and (ii) there is objective and reliable evidence of the fair value of the undelivered item(s). The total fixed or determinable amount of the arrangement is allocated to the separate units of accounting based on its relative fair value. However, when an amount allocated to a delivered item is contingent upon the delivery of additional items or meeting specified performance conditions, the amount allocated to that delivered item is limited to the non-contingent amount. This case arises when selling bundled offers that include a handset sold at a discounted price and a telecommunications service contract.

The handset is considered to have value on a standalone basis to the customer, and there is objective and reliable evidence of fair value for the telecommunications service to be delivered. As the amount allocable to the handset generally exceeds the amount received from the customer at the date the handset is delivered, revenue recognized for the handset sale is generally limited to the amount of the arrangement that is not contingent upon the rendering of telecommunication services, i.e. the amount paid by the customer for the handset.

Orange Dominicana, S. A.
Notes to the Financial Statements (Continued)
December 31, 2013 and 2012
(Amounts expressed in Dominican pesos-RD\$)

2—Accounting policies (Continued)

For offers that cannot be separated into identifiable components, revenues are recognized in full over the life of the contract. The main example is connection to the service: this does not represent a separately identifiable transaction from the subscription and communications, and connection fees are therefore recognized over the average expected life of the contractual relationship.

2.3.2 Equipment sales

Revenues from mobile sales are recognized when the significant risks and rewards of ownership are transferred to the buyer.

When equipment—associated to the subscription of telecommunication services—is sold by a third party retailer who purchases it from ODO and receives a commission for signing up the customer, the related revenue is:

- Recognized when the equipment is sold to the end-customer;
- Measured by ODO taking into account the best estimate of the retail price and any subsidies granted to the retailer at the time of the sale and passed on to the end-customer in the form of a rebate on the equipment.

2.3.3 Service revenues

Considerations from telephone service are recognized in revenue on a straight-line basis over the subscription period.

Revenue for airtime usage and messaging by customers is recognized as services are performed, with unbilled revenue resulting from services already provided accrued at the end of each period and unearned revenue from services to be provided in future periods deferred. Revenue from the sale of prepaid credit is deferred until such time as the customer uses the airtime, or the credit expires.

2.3.4 Loyalty programs

Points awarded to customers are treated as a separable component to be delivered in the transaction that triggered the acquisition of points. Part of the invoiced revenue is allocated to these points based on their fair value taking into account an estimated utilization rate, and deferred until the date at which the points are definitively converted into benefits. Fair value is defined as the excess price over the sales incentive that would be granted to any new customer. This principle is applied for both types of loyalty programs that exist within ODO, those with and those without a contractual renewal obligation.

2.4 Trade receivables

The trade receivables are mainly short-term, bearing no interest rate and measured at original invoice amount.

The valuation allowance on trade receivables is determined as follows:

- **For mobile telephone services:** The allowance is computed based on expected loss rates depending upon their aging. These rates are reviewed and adjusted periodically. When a client is determined to be in bankruptcy or subject to equivalent judicial proceedings, the associated receivables are then excluded from the statistical database and individually written-off;
- **For dealers, wholesalers, interconnection (local and roaming) and carriers:** The impairment loss is determined on a case by case analysis based on the ODO's experience.

Orange Dominicana, S. A.
Notes to the Financial Statements (Continued)
December 31, 2013 and 2012
(Amounts expressed in Dominican pesos-RD\$)

2—Accounting policies (Continued)

2.5 Purchases and operating expenses

Subscriber acquisition and retention costs

Subscriber acquisition and retention costs, other than loyalty programs costs, are recognized as an expense for the period in which they are incurred.

Advertising and sponsoring costs

Advertising, promotion, sponsoring, communications and brand marketing costs are expensed as incurred.

Financing expenses

Expenses from commissions, foreign currency exchange and other financing expenses are recorded with charge to the period result.

2.6 Inventories

The inventories comprise mainly mobile handsets either located in ODO's premises or at distributors until the customer service activation.

The inventories are stated at the lower of cost or net realizable value taking into account expected revenues from the sales of mobile phones. Cost corresponds to purchase cost determined using the weighted average cost method.

2.7 Trade payables

Payables are recorded at their nominal value.

2.8 Provisions and contingent liabilities

2.8.1 Provisions

In the ordinary course of business, ODO is involved in certain legal and arbitration proceedings and administrative actions.

The costs which may result from these proceedings are accrued when ODO has a present obligation towards a third party and it is probable that an outflow of resources embodying economic benefits will be required to settle the obligation and the amount of that liability can be quantified or estimated within a reasonable range. The amount of provision recorded is based on a case-by-case assessment of the risk level, and events arising during the course of legal proceedings may require a reassessment of this risk.

2.8.2 Contingent liabilities

Contingent liabilities are:

- Possible obligations that are not recognized because their existence will be confirmed only by the occurrence or non-occurrence of one or more uncertain future events not wholly within ODO's control; or
- Present obligations arising from past events that are not recognized because it is not probable that an outflow of resources embodying economic benefits will be required to settle the obligation or because the amount of the obligation cannot be measured with sufficient reliability.

Orange Dominicana, S. A.
Notes to the Financial Statements (Continued)
December 31, 2013 and 2012
(Amounts expressed in Dominican pesos-RD\$)

2—Accounting policies (Continued)

2.9 Employee benefits

Labor costs are expensed as incurred including social costs contributed by the Company in accordance with the law 87-01.

This law establishes that the employer will contribute to the financing of the contributing regime, as much for old aged insurance; handicaps (AFP) with 7.10% and family health (SFS) with 7.09% based on the wages and the employee will cover 2.87% and 3.04% respectively.

Employees are not provided with postemployment benefits.

2.10 Intangible assets, property, plant and equipment

2.10.1 Intangible assets

Intangible assets comprise mainly licenses for software and international telecommunication, frequency rights and Indefeasible Rights of Use (IRUs).

IRUs acquired by ODO correspond to the right to use cable or capacity transmission cable granted for a fixed period. They are recognized as an asset when ODO has the specific indefeasible right to use an identified portion of the underlying asset, generally optical fibers or dedicated wavelength bandwidth, and the duration of the right is for the major part of the underlying asset's economic life.

2.10.2 Property, plant and equipments

Property, plant and equipment comprised mainly network equipment.

The gross value of tangible assets corresponds to their acquisition or production cost, including costs directly attributable to bringing the asset to the location and condition necessary for it to be capable of operating in the manner intended by management.

Due to 2004 and 2005 hyperinflation in Dominican Republic, ODO restated its 2004 and 2005 financial statements applying IAS 29 *Financial Reporting in Hyperinflationary Economies* and adjusted consequently the gross value of assets with the corresponding balance within Shareholders' equity (i.e. Hyperinflation reserve).

The cost of networks includes design and construction costs. Maintenance and repair costs are expensed as incurred, except where they increase the asset's productivity or extend its useful life.

2.10.3 Depreciation

Assets are depreciated, generally with no residual value, on a basis that reflects the pattern in which their future economic benefits are expected to be consumed. The straight-line basis is usually applied. The

Orange Dominicana, S. A.
Notes to the Financial Statements (Continued)
December 31, 2013 and 2012
(Amounts expressed in Dominican pesos-RD\$)

2—Accounting policies (Continued)

useful lives are reviewed annually and are adjusted if current estimated useful lives differ from previous estimates: these changes in accounting estimates are recognized prospectively.

<u>Main assets categories</u>	<u>Useful Lives in Years</u>
Licences	3 - 5
Frequencies	10 - 15
IRU (Indefeasible rights of use)	10 - 15
Buildings	30
Antennas and technical equipment installed (sites)	8 - 28
Other technical equipment	3 - 8
Office material and software	3 - 5
Office furniture and equipment	5 - 10
Leased improvements	10

2.10.4 Dismantling

ODO is required to dismantle equipment and restore sites.

The provision is based on dismantling costs (on a per-unit basis for telephone poles, terminals and public phones, and on a per-site basis for mobile antennae) incurred by ODO to meet its environmental commitments and annual estimated asset dismantling and site restorations. The provision is assessed on the basis of the identified costs for the current financial year, extrapolated for future years using the best estimate of the commitment settlement. It is discounted at a risk-free rate. This estimate is revised annually and adjusted where appropriate against the asset to which it relates.

2.11 Financial instruments

The International Financial Reporting Standards (IFRS) require the disclosure of the estimated value of financial instruments, when it is practical to estimate their fair market value. The method and assumptions used to estimate the fair value of the active financial instruments like cash and cash equivalents, trade accounts receivable and payable, consisted in the approximate book value given the short expiration time of these instruments.

2.12 Income tax

Current tax is measured by ODO at the amount expected to be paid or recovered from the taxation authorities, based on its interpretation with regard to the application of tax legislation.

Deferred taxes are recognized for all temporary differences between the book values of assets and liabilities and their tax basis, using the liability method. Deferred tax assets are recognized only when their recovery is considered probable.

Deferred tax assets and liabilities are not discounted.

At reporting period end, ODO reviews the recoverable amount of the deferred tax assets.

In accordance with these principles, ODO calculates the tax assets, liabilities and accruals recognized in the statement of financial position based on the technical merits of the positions it defends versus that of the tax authorities.

Deferred tax assets and liabilities are measured at the expected tax rates for the year during which the assets will be realized and the liabilities settled on the basis of tax rates in force or substantially in force at the period end.

2.13 Cash and cash equivalents

Cash and cash equivalents are defined as cash on hand, demand deposits and short-term investments with original maturity at the date of acquisition of three month or less.

Orange Dominicana, S. A.
Notes to the Financial Statements (Continued)
December 31, 2013 and 2012
(Amounts expressed in Dominican pesos-RD\$)

3—Financial risk management

The Company is exposed to the following risks related to the use of financial instruments:

- Credit Risk
- Liquidity Risk
- Market Risk

3.1 Credit Risk

It is the risk of financial loss of the company if a client or the counterpart of a financial instrument, do not fulfill its contractual obligations. It comes from Cash and Receivables accounts mainly. This risk is primarily impacted by the quality and characteristics of every client.

The revenues of the Company are the results from the telecommunication services and the sale of mobiles. Accounts receivable arise with the billing to our customers and sales to wholesalers and distributors.

The company estimates the potential losses on the trade receivable accounts and other receivables based on specific components related to individual characteristics for which there is a reserve for bad debt.

3.2 Liquidity Risk

It is the risk that the company does not meet its financial obligations when dues. The policy of the company in regards to the management of the liquidity risk is to have, to the extent possible, sufficient liquidity to redeem all the current liabilities at their corresponding maturities, under normal circumstances as well as in economic crisis also without having to incur in unacceptable losses or risk damaging the company's reputation.

3.3 Market Risk

It is the risk of changes in the market price (or rates) such as exchange rates of foreign currency and interest rates that might have an impact on the net results or the value of the financial instruments owned by the company. The objective of this management is to control the exposure to this risk within acceptable parameters while improving the return of this risk.

The company is exposed to the foreign exchange risk in the purchase of goods and services denominated in dollars (US\$) and euros (EUR), which are currencies different from the reporting currency of the company, as well as for keeping assets and liabilities in those currencies without having a financial instrument to cover the exchange risk.

4—Revenues

A detail of revenues as of December 31,2013 and 2012 is as follows:

	<u>2013</u>	<u>2012</u>
Mobile	20,503,053,000	19,436,051,000
Wholesale	1,815,813,000	1,662,445,000
Internet	644,159,000	507,036,000
Equipment	1,151,349,000	866,134,000
Other	290,350,867	282,707,505
	<u>24,404,724,867</u>	<u>22,754,373,505</u>

Orange Dominicana, S. A.
Notes to the Financial Statements (Continued)
December 31, 2013 and 2012
(Amounts expressed in Dominican pesos-RD\$)

5—Trade receivables

A detail of the trade receivables as of December 31, 2013 and 2012 is as follows:

	<u>2013</u>	<u>2012</u>
Customers (gross)	2,293,630,201	2,424,943,725
Provision for doubtful accounts	(460,743,090)	(487,534,820)
Customers (net of provision)	<u>1,832,887,111</u>	<u>1,937,408,905</u>

A detail of accounts receivables with an aging as of December 31, 2013 and 2012 is as follows:

	<u>2013</u>	<u>2012</u>
Not due or less than 30 days	1,438,538,202	1,251,365,210
Between 30 and 60 days	238,936,495	654,176,575
Between 60 and 90 days	106,597,280	181,345,679
More than 90 days	509,558,224	338,056,261
	<u>2,293,630,201</u>	<u>2,424,943,725</u>

ODO 2012 figures have been restated in order to make possible the comparability between years 2013 and 2012. The restatement consisted in a netting between the trade receivables and the trade payables for an amount of RD\$633,372,811.

6—Other receivables

A detail of the other receivables as of December 31, 2013 and 2012 is as follows:

	<u>2013</u>	<u>2012</u>
Advances to suppliers	171,599,490	296,156,659
VAT	216,507,994	158,393,560
Cash pooling—current account	2,566,699,740	135,623,414
Others	17,707,835	39,281,085
	<u>2,972,515,059</u>	<u>629,454,718</u>

7—Deferred income

A detail of deferred income as of December 31, 2013 and 2012 is as follow:

	<u>2013</u>	<u>2012</u>
Prepaid telephone cards	906,677,451	768,069,643
Loyalty program	481,072,839	511,072,839
Monthly fee	119,517,977	130,045,686
Handsets	91,950,897	237,384,310
Sim cards	(1,915,891)	68,415,160
	<u>1,597,303,273</u>	<u>1,714,987,638</u>

Orange Dominicana, S. A.
Notes to the Financial Statements (Continued)
December 31, 2013 and 2012
(Amounts expressed in Dominican pesos-RD\$)

8—Cost of equipment sold

The costs of equipment sold comprise purchases of handsets and other Sim and phone cards, as well as all costs directly attributable to them (mainly import duties and freight charges). A detail of cost of equipment sold as of December 31, 2013 and 2012 is as follow:

	<u>2013</u>	<u>2012</u>
Terminals	(3,005,732,352)	(2,691,685,132)
SIM cards	(117,495,603)	(134,380,975)
Import duties and freight costs	(95,833,246)	(123,264,823)
Phone cards	(37,918,765)	(50,750,362)
Accessories	(167,880)	168,291
Other	(1,743,347)	(196,166)
	<u>(3,258,891,193)</u>	<u>(3,000,109,167)</u>

9—Selling, distribution and traffic costs

A detail of the selling, distribution and traffic costs as of December 31, 2013 and 2012 is as follows:

	<u>2013</u>	<u>2012</u>
Selling and distribution costs	(2,280,230,331)	(2,181,628,470)
National voice mobile terminations	(1,798,145,387)	(1,766,511,266)
National voice fixed line terminations	(170,473,269)	(222,273,638)
International terminations	(501,946,684)	(497,571,059)
Data terminations (SMS)	(227,304,467)	(215,589,932)
International roaming	(66,724,930)	(76,658,280)
Other	(1,217,784,156)	(900,958,904)
	<u>(6,262,609,226)</u>	<u>(5,861,191,549)</u>

10—Others costs and income

A detail of the other costs and income as of December 31, 2013 and 2012 is as follows:

	<u>2013</u>	<u>2012</u>
Other income	192,711,837	127,281,750
Purchase of services	(442,714,740)	(453,543,414)
Network energy	(509,614,096)	(432,777,929)
Consulting, contractors & prof. serv.	(258,883,238)	(309,892,025)
Bad debt expense	(183,177,721)	(212,931,032)
IT expenses	(169,508,120)	(178,198,199)
Temporary staff / interim net ^(a)	(77,145,048)	(78,477,569)
Purchases of supplies	(133,406,463)	(137,764,003)
Operating tax	(49,702,291)	(137,062,235)
Other	(712,147,693)	(759,148,594)
	<u>(2,343,587,573)</u>	<u>(2,572,513,250)</u>

(a) The temporary labor expenses attributable to the network development are net of costs capitalized (RD\$ 89,832,817 and RD\$ 71,335,720, respectively for 2013 and 2012).

Orange Dominicana, S. A.
Notes to the Financial Statements (Continued)
December 31, 2013 and 2012
(Amounts expressed in Dominican pesos-RD\$)

11—Inventories

As of December 31, 2013 and 2012, inventories are composed of equipments, accessories and prepaid cards and a detail of the same is as follows:

	<u>2013</u>	<u>2012</u>
ODO's warehouse	933,564,620	572,890,663
ODO's distributors (dealers)	100,784,043	310,070,460
	<u>1,034,348,663</u>	<u>882,961,123</u>

12—Trade payables

A detail of trade payables as of December 31, 2013 and 2012 is as follows:

	<u>2013</u>	<u>2012</u>
Fixed assets and operating suppliers	1,974,180,451	2,476,250,462
Related companies (see note 24)	327,464,583	314,449,212
Distributors (dealer)	175,108,372	164,294,562
Merchandises suppliers	646,847,845	540,481,470
Others	128,521,664	9,176,095
	<u>3,252,122,915</u>	<u>3,504,651,801</u>

ODO 2012 figures have been restated in order to make possible the comparability between years 2013 and 2012. The restatement consisted in a netting between the trade receivables and the trade payables for an amount of RD\$633,372,811.

13—Other current liabilities

A detail of the other current liabilities as of December 31, 2013 and 2012 is as follows:

	<u>2013</u>	<u>2012</u>
Taxes and VAT	464,918,913	455,803,544
Staff bonuses	228,037,124	213,293,578
Vacations and other	28,086,482	28,631,492
	<u>721,042,519</u>	<u>697,728,614</u>

14—Labor expenses

A detail of labor expenses as of December 31, 2013 and 2012 is as follows:

	<u>2013</u>	<u>2012</u>
Salaries and wages ^(a)	(766,797,062)	(758,861,075)
Employee profit sharing	(181,597,181)	(167,749,604)
Social contribution	(156,712,236)	(143,296,628)
Others	(128,786,005)	(104,821,663)
	<u>(1,233,892,484)</u>	<u>(1,174,728,970)</u>

(a) According to the Company's policies and standards, personnel expenses that work at Network development are capitalized at the project for which such personnel is working. As of December 31, 2013 and 2012 the capitalized amounts for this concept are for RD\$296,338,497 and RD\$266,039,069, respectively.

Orange Dominicana, S. A.
Notes to the Financial Statements (Continued)
December 31, 2013 and 2012
(Amounts expressed in Dominican pesos-RD\$)

15—Intangible assets

A detail of intangible assets as of December 31, 2013 and 2012 is as follows:

	2013				2012
	Frequencies	Software licenses & IRU	Rights of use corporate solutions	Total	
Acquisition cost at beginning of the year	1,192,676,947	4,094,656,072	132,852,964	5,420,185,983	4,782,110,362
Acquisition	—	571,843,256	20,830,486	592,673,742	696,046,488
Disposals	—	(9,204,595)	—	(9,204,595)	(14,352,199)
Reallocations	(1,213,414)	(81,673,682)	—	(82,887,096)	(43,618,668)
	<u>1,191,463,533</u>	<u>4,575,621,051</u>	<u>153,683,450</u>	<u>5,920,768,034</u>	<u>5,420,185,983</u>
Minus:					
Amortization beginning of the year	(593,324,201)	(2,525,276,116)	(89,896,717)	(3,208,497,034)	(2,534,475,883)
Depreciation expense	(164,000,969)	(537,019,777)	(19,951,667)	(720,972,413)	(688,373,350)
Disposals	—	9,204,595	—	9,204,595	14,352,199
Reallocations	1,213,414	111,658,323	—	112,871,737	—
	<u>(756,111,756)</u>	<u>(2,941,432,975)</u>	<u>(109,848,384)</u>	<u>(3,807,393,115)</u>	<u>(3,208,497,034)</u>
	<u>435,351,777</u>	<u>1,634,188,076</u>	<u>43,835,066</u>	<u>2,113,374,919</u>	<u>2,211,688,949</u>

For the period ended December 31, 2013, the reallocations mainly comprise a reclassification between gross value and depreciation due to hyperinflation effect for an amount of MDOP 70. ODO stopped the Hyperinflation restatement in the year 2006.

16—Property, plant and equipments

As of December 31, 2013 and 2012, a detail and movement of property, plant and equipments, is as follows:

	2013					Total	2012
	Lands	Buildings	Network and transmission equipment	IT infrastructure	Others assets		
Acquisition cost at the beginning of the year	158,783,979	1,720,670,474	25,760,775,863	2,159,692,072	188,739,491	29,988,661,879	27,229,194,068
Acquisition	—	138,461,731	2,134,286,957	321,717,199	11,469,338	2,605,935,225	2,941,068,823
Disposals	—	(14,464,500)	(23,727,600)	(4,732,703)	(23,197)	(42,948,000)	(91,446,590)
Reallocations	1,522,130	(72,112,894)	(1,198,124,642)	(123,916,851)	(3,969,652)	(1,396,601,910)	(90,154,421)
	<u>160,306,109</u>	<u>1,772,554,811</u>	<u>26,673,210,578</u>	<u>2,352,759,717</u>	<u>196,215,980</u>	<u>31,155,047,195</u>	<u>29,988,661,879</u>
Accumulated depreciation							
Beginning of the year	—	(814,069,448)	(13,670,410,515)	(1,529,631,424)	(101,029,288)	(16,115,140,675)	(13,384,994,371)
Depreciation expense	—	(249,827,873)	(2,283,638,600)	(248,688,454)	(15,136,398)	(2,797,291,325)	(2,820,831,628)
Disposals	—	44,480	23,727,600	4,732,703	23,217	28,528,000	90,685,324
Reallocations	—	70,590,764	1,219,821,688	123,916,851	3,969,652	1,418,298,955	—
	<u>—</u>	<u>(993,262,077)</u>	<u>(14,710,499,827)</u>	<u>(1,649,670,324)</u>	<u>(112,172,817)</u>	<u>(17,465,605,045)</u>	<u>(16,115,140,675)</u>
	<u>160,306,109</u>	<u>779,292,734</u>	<u>11,962,710,751</u>	<u>703,089,393</u>	<u>84,043,163</u>	<u>13,689,442,150</u>	<u>13,873,521,204</u>

For the period ended December 31, 2013, the reallocations mainly comprise a reclassification between gross value and depreciation due to hyperinflation effect for an amount of MDOP 1,461. ODO stopped the Hyperinflation restatement in the year 2006.

Orange Dominicana, S. A.
Notes to the Financial Statements (Continued)
December 31, 2013 and 2012
(Amounts expressed in Dominican pesos-RD\$)

17—Non-current liabilities

A detail of the non-current liabilities as of December 31, 2013 and 2012 is as follows:

	<u>2013</u>	<u>2012</u>
Customer deposit	213,025,325	203,084,345
Provisions	259,834,847	343,923,698
ARO provisions	159,247,179	97,667,735
	<u>632,107,351</u>	<u>644,675,778</u>

18—Income Tax

The tax expense shown in the income statement as of December 31, 2013 and 2012 is as follows:

	<u>2013</u>	<u>2012</u>
Current Income Tax	(1,625,181,190)	(1,462,560,892)
Deferred Income Tax	184,181,317	332,500,698
Dividends Credits	—	329,753,087
Tax credits from Law 57-2007 incentives	51,065,771	10,375,360
	<u>(1,389,934,101)</u>	<u>(789,931,748)</u>

The reconciliation between the profit before income tax as per the income statements, and the income tax expense is as follows:

	<u>2013</u>	<u>2012</u>
Profit before income tax	<u>5,286,960,759</u>	<u>4,236,199,291</u>
29% Income tax rate on profit before income tax	(1,533,218,620)	(1,228,497,795)
Tax effect of:		
Dividends credits	—	329,753,087
Inflation adjustment applied to depreciable fixed assets	180,034,077	168,732,345
Effect of change in tax rate on deferred income tax	(15,882,170)	46,475,938
Adjustment to current tax of prior year	9,418,271	(63,714,428)
Other	(30,285,660)	(42,680,895)
Effective income tax	<u>(1,389,934,101)</u>	<u>(789,931,748)</u>
Effective tax rate	<u>26.3%</u>	<u>18.6%</u>

The reconciliation of the income tax payable/receivable as of December 31, 2013 and 2012 is as follows:

	<u>2013</u>	<u>2012</u>
Advances of the period	1,003,996,777	497,442,249
Prior year tax credit carried forward	272,645,963	796,762,816
Tax credit from Law 57-2007 incentives	51,065,771	10,387,949
Credit arising from dividends withholdings	—	329,753,087
Current tax provision	(1,625,181,190)	(1,398,846,464)
	<u>(297,472,679)</u>	<u>235,499,637</u>

Orange Dominicana, S. A.
Notes to the Financial Statements (Continued)
December 31, 2013 and 2012
(Amounts expressed in Dominican pesos-RD\$)

18—Income Tax (Continued)

The deferred income tax as of December 31, 2013 and 2012 is composed as follows:

	2013		2012	
	Balance Sheet	Income Statement	Balance Sheet	Income Statement
Deferred tax assets				
Provisión for Loyalty Program . . .	129,889,667	8,100,000	137,989,667	15,151,457
Depreciable fixed assets	1,275,118,503	(174,222,770)	1,100,895,733	(257,394,884)
Provisión for bad debts	162,720,514	(14,886,601)	147,833,913	(14,097,955)
Provisión inventory obsolescence .	—	21,801,449	21,801,449	(774,224)
Other provisions	340,909,820	(15,574,814)	325,335,006	(50,898,550)
Vacations and incentives provisión	10,059,344	(348,063)	9,711,281	1,119,279
Deferred revenues /cost.		1,878,678	1,878,678	(10,349,938)
Exchange difference	409,220	(409,220)	—	1,554,733
	<u>1,919,107,069</u>	<u>(173,661,342)</u>	<u>1,745,445,727</u>	<u>(342,060,370)</u>
Deferred tax liabilities	—			
Exchange difference	—	(967,120)	(967,120)	—
Deferred revenues/costs	(291,969)	—	—	—
Effect of IAS29 adjustment	(112,484,622)	(9,844,825)	(122,329,447)	9,559,672
	<u>(112,776,591)</u>	<u>(10,519,975)</u>	<u>(123,296,567)</u>	<u>9,559,672</u>
Net deferred tax	<u>1,806,330,478</u>	<u>(184,181,317)</u>	<u>1,622,149,160</u>	<u>(332,500,698)</u>

19—Cash and cash equivalents

A detail of cash and cash equivalents as of December 31, 2013 and 2012 is as follows:

	2013	2012
Cash on hand	1,357,000	944,811
Cash at banks	1,037,568,338	1,158,645,957
	<u>1,038,925,338</u>	<u>1,159,590,768</u>

20—Share capital

The General Assembly of Shareholders decided on December 19, 2012 the capitalization of retained earnings to increase the authorized capital by adding 38,000,000 shares. Therefore the new amount of shares is 58,000,000 at RD\$100 each.

As of December 31, 2013 and 2012 the outstanding capital paid is composed by 58,000,000 shares for a total amount of RD\$5,800,000,000.

21—Legal reserve

The Commercial Code of the Dominican Republic in its article number 58 provides that the Company appropriate no less than 5% annually of net annual result until the total appropriated amount equals 10% of paid in capital. This reserve cannot be capitalized, transferred to retained earnings or to use to pay dividends.

Orange Dominicana, S. A.
Notes to the Financial Statements (Continued)
December 31, 2013 and 2012
(Amounts expressed in Dominican pesos-RD\$)

22—Remittance of dividends

ODO shareholders meeting approved the payment of dividends in May 2013 for a total amount of RD\$1,855,350,000.

In November 2012 was enacted the law 253-12 of fiscal reform, establishing that dividend payments will be subject to withholding and payment of 10% of income tax as a unique payment, but not constitute anymore a tax credit for the Company.

23—Foreign currency balances

ODO is exposed to foreign exchange risk due both to its revenues and purchases denominated in US dollars and euros. As a consequence, these foreign operations have a direct effect on the operating, finance income and the trade receivables and payables.

	2013	2012
Revenues:		
DOP	17,802,800,534	16,471,989,318
EUR	207,730,868	265,314,558
USD	6,394,193,465	6,017,069,386
Multi currencies (Gas & Electricity)	—	242
	24,404,724,867	22,754,373,505
Operating expenses:		
DOP	5,785,647,203	5,829,181,877
EUR	1,078,234,834	1,077,968,440
USD	8,124,416,046	7,581,584,880
Multi currencies (Gas & Electricity)	566,493,055	535,393,613
	15,554,791,137	15,024,128,810
Fixed assets acquisitions:		
DOP	1,973,936,902	1,533,906,442
EUR	580,512,336	901,068,402
USD	644,159,547	1,202,140,466
	3,198,608,785	3,637,115,310

Orange Dominicana, S. A.
Notes to the Financial Statements (Continued)
December 31, 2013 and 2012
(Amounts expressed in Dominican pesos-RD\$)

24—Balances and transactions with related parties

The Company made transactions and keeps balances with related parties as part of the normal operations business. Detail of the most significant transactions and balance with related companies as of December 31, 2013 and 2012 are as follows:

	2013	2012
Balances:		
Accounts receivable ^(a)	23,797,027	29,223,556
Cash pooling-current account ^(a)	2,566,699,740	164,846,970
Accounts payable	(327,464,583)	(314,449,212)
Transactions:		
Revenue (traffic, interconnection and other income)	239,872,138	218,902,968
Selling distribution and traffic coast	(87,279,542)	(66,186,204)
Brand fees ^(b)	(376,940,510)	(351,549,524)
Corporate management fees ^(c)	(251,550,752)	(231,146,089)
General maintenance and services	(14,988,993)	(9,896,989)
Other operational expenses, net	(66,568,920)	(102,414,970)
Other operational income	195,501	12,636,008

(a) In February 2009, Orange S. A. and ODO signed a centralized treasury management agreement (CTMA). Orange S. A. thus optimizes the Group liquidity. ODO lends or borrows its cash surplus/needs through a current account with Orange S. A.

The cash pooling accounts bear interest which is calculated on a daily balance and on a daily basis using:

- for the EUR account: EONIA rate for a credit balance and EONIA plus 2.15% margin for a debit balance
- for the USD account: LIBOR Overnight rate for a credit balance and LIBOR Overnight plus 2.15% margin for a debit balance

(b) The utilization of the Orange brand name is defined in a brand license agreement signed with Orange Group and costs a 1.6% fee of the ODO's monthly operating revenue.

(c) Management fees are determined in accordance with an agreement signed with Orange S. A. and are charged using a 1.03% on the monthly contributive operational revenue in 2012.

25—Unrecognized contractual commitments

As at December 31, 2013 and 2012 the contractual commitments are as follows:

Leasing commitments

The Company keeps operating rent agreements with enterprises and physical persons for the concept of commercial offices rent, parking, housing, and signal transmission antennas. Almost always these agreements are automatically renewable and are monthly, quarterly or four-monthly paid. During the years ended as of December 2013 and 2012, the Company paid for this concept the amounts of RD\$632,221,641 and RD\$563,689,755, respectively. The commitment for 2014 for this concept is an estimated RD\$604,992,425.

	1 year	1 to 5 years	over 5 years	Total
Rental commitments by year of expiration	604,992,425	1,405,898,412	433,504,377	2,444,395,214

Orange Dominicana, S. A.
Notes to the Financial Statements (Continued)
December 31, 2013 and 2012
(Amounts expressed in Dominican pesos-RD\$)

25—Unrecognized contractual commitments (Continued)

Other purchase and investment commitments

A detail of other purchase and investment commitments as of December 31, 2013 is as follows:

	<u>2013</u>
Other opex commitments	400,809,386
Capex commitments	1,122,622,135
Handset purchase commitments	<u>1,095,445,309</u>

- Other opex commitment are relating to marketing, network, gas distribution and civil engineering.
- Capital expenditures mainly related to network projects.

26—Litigation

As of December 31, 2013, ODO is party of certain judicial procedures with former distributors or dealers, for which no provision is recorded as ODO considers at this stage of the procedure that the claims are without merit.

27—Financial Instruments

The financial risks to which the Company is exposed are presented in the following paragraphs.

Foreign exchange risks

The Company is exposed to risk profit or loss in the fluctuation of the exchange rates of foreign currencies that arise, principally the US dollar and Euro. During the year 2003 an accelerated depreciation of the local currency occurred. Nevertheless since the middle of the year 2005 and 2006, the Dominican currency (DOP) has strengthened in relation to the American dollar and Euro and has been quite stable ever since. As of December 2013 and 2012, the Company has assets and liabilities in US dollars and Euros. See note 23.

Credit risk

As of December 31, 2013, credit risk exposure is very limited. Such risk is that Company cannot recover the accounts receivable. The major credit risk is represented by balance of each financial asset. The Company for controlling the credit risks and collects the balances with local distributors imposes to open letters of credit as a warranty to cover any issue that may come up from those clients.

Liquidity Risk

Management is conscious of the implications of liquidity risk. In that sense, it maintains an adequate cash balance.

Orange Dominicana, S. A.
Notes to the Financial Statements (Continued)
December 31, 2013 and 2012
(Amounts expressed in Dominican pesos-RD\$)

28—Fair Value of financial instruments

A detail of the balances booked and the estimated as fair value of the Company financial instruments as of December 31, 2013 and 2012 is as follow:

	2013		2012	
	Accounting Amount	Fair Value	Accounting Amount	Fair Value
Financial Assets:				
Cash	1,038,925,338	1,038,925,338	1,159,590,768	1,159,590,768
Trade receivables	1,832,887,111	1,832,887,111	1,937,408,905	1,937,408,905
Other receivables	<u>2,972,515,059</u>	<u>2,972,515,059</u>	<u>629,454,718</u>	<u>629,454,718</u>
Financial Liabilities:				
Trade payables	3,252,122,915	3,252,122,915	3,504,651,801	3,504,651,801
Other current liabilities	<u>721,042,519</u>	<u>721,042,519</u>	<u>697,728,614</u>	<u>697,728,614</u>

29—Non-recurring transaction

On November 26th, 2013 the Company Wirefree Services Denmark A / S, the major shareholder of Orange Dominicana, S. A., signed a contract with the economic Group Altice, of Luxembourg, for the sale of the 100% of the shares of Orange Dominicana, S. A. As at December 31st, 2013 such transaction is still in the process of validation by the Instituto Dominicano de las Telecomunicaciones (INDOTEL).

30—Subsequent events

No event other than those described above has occurred since the year end.

ORANGE DOMINICANA, S.A.

Standalone Financial Statements

As of and for the two years ended December 31, 2012

INDEPENDENT AUDITORS' REPORT

To the Board of Directors and Shareholders of Orange Dominicana

We have audited the accompanying balance sheets of Orange Dominicana (the "Company") as of December 31, 2012 and 2011, and the related statements of income, shareholders' equity, and cash flows for the years then ended. These financial statements are the responsibility of the Company's management. Our responsibility is to express an opinion on these financial statements based on our audits.

We conducted our audits in accordance with auditing standards generally accepted in the United States of America. Those standards require that we plan and perform the audit to obtain reasonable assurance about whether the financial statements are free of material misstatement. An audit includes consideration of internal control over financial reporting as a basis for designing audit procedures that are appropriate in the circumstances, but not for the purpose of expressing an opinion on the effectiveness of the Company's internal control over financial reporting. Accordingly, we express no such opinion. An audit also includes examining, on a test basis, evidence supporting the amounts and disclosures in the financial statements, assessing the accounting principles used and significant estimates made by management, as well as evaluating the overall financial statement presentation. We believe that our audits provide a reasonable basis for our opinion.

In our opinion, such financial statements present fairly, in all material respects, the financial position of the Company as of December 31, 2012 and 2011, and the results of its operations and its cash flows for the years then ended in conformity with International Financial Reporting Standards ("IFRS") as issued by the IASB.

DELOITTE & ASSOCIÉS

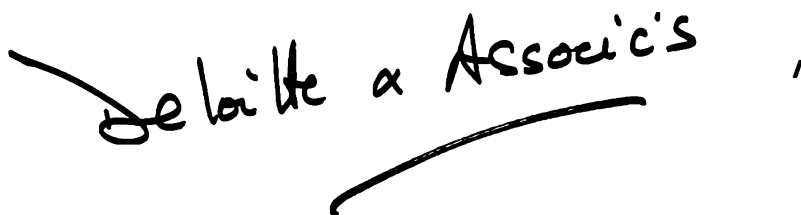
A handwritten signature in black ink that reads "Deloitte & Associés". The signature is written in a cursive, slightly slanted style. A long horizontal line is drawn underneath the signature, extending from the start of the word "Deloitte" to the end of "Associés".

Neuilly-sur-Seine,
September 18, 2013

France

Orange Dominicana, S.A.

INDEX

	<u>Page</u>
Income statement	F-261
Statement of financial position	F-262
Statement of cash flows	F-263
Statements of changes in equity	F-264
Notes to the financial statements	F-265

Orange Dominicana, S.A.
Income statement

<u>Income statement</u>	<u>Notes</u>	<u>2012</u>	<u>2011</u>
		(in Dominican pesos)	
Revenues	3.1	22,754,373,505	22,183,989,151
Cost of equipment sold	4.1	(3,000,109,167)	(3,370,231,069)
Selling, distribution and traffic costs	4.2	(5,861,191,549)	(5,899,205,178)
Advertising and sponsoring costs		(937,385,613)	(1,053,899,861)
Offices and technical sites costs		(563,689,755)	(467,358,296)
Labor expenses	5	(1,174,728,970)	(1,061,299,445)
Corporate fees		(582,695,613)	(580,165,980)
Maintenance costs		(331,814,892)	(304,579,553)
Other costs and income	4.3	(2,572,513,250)	(1,975,054,438)
Depreciation and amortization	6.1/6.2	(3,509,204,978)	(3,354,660,775)
Total costs and operating expenses		<u>(18,533,333,788)</u>	<u>(18,066,454,595)</u>
Operating income		4,221,039,717	4,117,534,556
Bank commissions		(70,778,482)	(65,901,033)
Interest income		36,522,740	64,620,300
Foreign currency exchange gains (losses)		69,838,887	16,776,620
Other		(20,423,571)	—
Non-operating income (expenses)		<u>15,159,574</u>	<u>15,495,887</u>
Profit before income tax		4,236,199,291	4,133,030,443
Income tax	7.1	(789,931,748)	(7,803,044)
Net income		3,446,267,543	4,125,227,399
Other comprehensive income		—	—
Total comprehensive income for the year		<u>3,446,267,543</u>	<u>4,125,227,399</u>

Orange Dominicana, S.A.
Statement of financial position

<u>Statement of financial position</u>	<u>Notes</u>	<u>2012</u>	<u>2011</u>
		(in Dominican pesos)	
Intangible assets, net	6.1	2,211,688,949	2,247,634,479
Property, plant and equipment, net	6.2	13,873,521,204	13,844,199,696
Other non-current assets		55,133,105	53,018,958
Deferred tax assets	7.4	1,622,149,160	1,289,648,460
Total non-current assets		17,762,492,418	17,434,501,593
Inventories	4.4	882,961,123	987,614,178
Trade receivables	3.2	2,570,781,717	2,511,763,302
Other receivables	3.3	629,454,718	626,817,254
Income tax receivable	7.3	235,499,637	860,477,397
Prepaid expenses		197,925,846	223,324,321
Cash and cash equivalents	8	1,159,590,768	1,144,656,534
Total current assets		5,676,213,809	6,354,652,985
Total assets		23,438,706,227	23,789,154,578
Share capital		5,800,000,000	1,752,869,800
Legal reserve		580,000,000	175,286,980
Decrease (increase) in other non-current liabilities		1,680,984,200	1,680,984,200
Retained earnings		8,182,305,384	12,532,661,061
Total Shareholders' equity	9	16,243,289,584	16,141,802,041
Non-current liabilities	6.3	644,675,778	618,016,036
Total non-current liabilities		644,675,778	618,016,036
Trade payables	4.5	4,138,024,612	4,621,399,985
Other current liabilities	4.6	697,728,614	734,596,096
Deferred income	3.4	1,714,987,638	1,673,340,422
Total current liabilities		6,550,740,864	7,029,336,502
Total equity and liabilities		23,438,706,227	23,789,154,578

Orange Dominicana, S.A.
Statement of cash flows

<u>Statement of cash flows</u>	<u>2012</u>	<u>2011</u>
	(in Dominican pesos)	
Operating activities		
Net income	3,446,267,543	4,125,227,399
<i>Adjustments to reconcile net profit to cash provided by operating activities</i>		
Depreciation and amortization	3,509,204,978	3,354,660,775
Gains (losses) on disposal	761,266	—
Change in provisions (Litigations, dismantling and others) . . .	67,719,013	(279,430,828)
Income tax	(332,500,700)	(413,429,415)
<i>Change in inventories, accounts receivable and payable</i>		
Decrease (increase) in inventories, net	104,653,055	259,796,748
Decrease (increase) in trade receivables, net	(59,018,415)	124,215,885
Decrease (increase) in other receivables, net	(2,637,465)	493,004,912
Increase (decrease) in trade payables	(483,375,372)	152,067,437
<i>Other changes in working capital requirements</i>		
Decrease (increase) in prepaid expenses	25,398,475	(56,936,423)
Decrease (increase) in other non-current assets	(2,114,147)	(29,302,650)
Decrease (increase) in other non-current liabilities	8,419,337	53,480,630
Decrease (increase) in other current liabilities	47,427,001	103,636,112
Deferred income	41,647,217	(59,088,382)
Income tax paid	624,977,760	(369,650,775)
Net cash provided by operating activities	<u>6,996,829,544</u>	<u>7,458,251,424</u>
Investing activities		
Purchase of PPE and intangible assets	(3,637,115,310)	(3,702,125,212)
Net cash used in investing activities	<u>(3,637,115,310)</u>	<u>(3,702,125,212)</u>
Financing activities		
Dividends paid	(3,344,780,000)	(3,252,300,000)
Net cash used in financing activities	<u>(3,344,780,000)</u>	<u>(3,252,300,000)</u>
Net increase (decrease) in cash and cash equivalents	14,934,234	503,826,212
Cash and cash equivalents—opening balance	1,144,656,534	640,830,322
Cash and cash equivalents—closing balance	<u>1,159,590,768</u>	<u>1,144,656,534</u>

Orange Dominicana, S.A.
Statement of change in equity

Statements of changes in equity	Capital	Legal Reserve	Hyperinflation reserve	Retained Earnings	Total
			(in Dominican pesos)		
Balance at 12/31/2010	1,752,869,800	175,286,980	1,680,984,200	11,659,733,662	15,268,874,642
Net income	—	—	—	4,125,227,399	4,125,227,399
Other comprehensive income	—	—	—	—	—
Total comprehensive income	—	—	—	4,125,227,399	4,125,227,399
Dividends paid (note 9.3)	—	—	—	(3,252,300,000)	(3,252,300,000)
Balance at 12/31/2011	1,752,869,800	175,286,980	1,680,984,200	12,532,661,061	16,141,802,041
Net income	—	—	—	3,446,267,543	3,446,267,543
Other comprehensive income	—	—	—	—	—
Total comprehensive income	—	—	—	3,446,267,543	3,446,267,543
Dividends paid (note 9.3)	—	—	—	(3,344,780,000)	(3,344,780,000)
Transfer to legal reserve	—	404,713,020	—	(404,713,020)	—
Capital increase	4,047,130,200	—	—	(4,047,130,200)	—
Balance at 12/31/2012	5,800,000,000	580,000,000	1,680,984,200	8,182,305,384	16,243,289,584

Orange Dominicana, S.A.
Notes to the standalone financial statements

Note 1—Description of business and basis of preparation of the standalone financial statements

1.1 Description of business

Orange Dominicana, S.A. (hereafter called “ODO”), a company incorporated in accordance with the Dominican Republic laws, began operations on November 13th 2000. ODO is an indirectly wholly-owned subsidiary of Orange S.A., a French listed company.

ODO operates under a service concession agreement for the operation of telecommunications services.

ODO provides consumers, businesses and other telecommunication operators with a wide range of services including mobile telecommunications, data transmission and other value added services.

1.2 Basis of presentation and purpose of the financial statements

These financial statements have been prepared in the context of the proposed sale of ODO by its sole shareholder and for use in any offering documents relating to securities that may be offered by ODO.

They have been prepared in accordance with International Financial Reporting Standards (IFRSs).

The principles applied to prepare financial data are based on:

- all standards and interpretations compulsory as of December 31, 2012;
- the recognition and measurement alternatives allowed by the IFRSs:

<u>Standard</u>	<u>Alternative used</u>
IAS 2 Inventories	Measurement of inventories determined by the weighted average unit cost method
IAS 16 Property, Plant and Equipment	Measurement at amortized historical cost
IAS 38 Intangible Assets	Measurement at amortized historical cost
<ul style="list-style-type: none"> • the available exemptions regarding the retrospective application of IFRSs at the transition date (January 1, 2004 for ODO): 	

<u>Standard</u>	<u>IFRS 1 alternative used</u>
IAS 16 and IAS 38 Property, Plant and Equipment and Intangible Assets	Measurement of property, plant and equipment and intangible assets at historical cost

In the absence of any accounting standard or interpretation, management uses its judgment to define and apply an accounting policy that will result in relevant and reliable information, such that the financial statements:

- present fairly the ODO’s financial position, financial performance and cash flows;
- reflect the economic substance of transactions;
- are neutral;
- are prepared on a prudent basis; and
- are complete in all material respects.

1.3 Standards and interpretations compulsory after December 31, 2012 with no early application elected by ODO

IFRS 13—Fair value measurement—defines fair value, sets out a framework for measuring fair value and requires disclosures about fair value measurements, including the fair value hierarchy already set out in

Orange Dominicana, S.A.
Notes to the standalone financial statements (Continued)

Note 1—Description of business and basis of preparation of the standalone financial statements (Continued)

IFRS 7. This standard is applicable prospectively and has no expected effect on the fair value currently measured by ODO.

1.4 Use of estimates and judgment

In preparing ODO's financial statements, the management makes estimates, insofar as many elements included in the financial statements cannot be measured with precision. These estimates are revised if the underlying circumstances evolve or in light of new information or experience. Consequently, estimates made at December 31, 2012 may subsequently be changed.

ODO's management also uses its judgment to define appropriate accounting policies to apply to certain transactions when the current IFRS standards and interpretations do not specifically deal with related accounting issues.

The underlying assumptions used for significant estimates are outlined below:

<u>Estimate</u>		<u>Nature of estimate</u>
Note 3.1	Revenue	Identification of separable components of a bundled offer based on the individual components relative fair value Period of straight-line recognition of revenue relating to invoiced service access fees depending on the nature of product and historical contractual relationship Reporting of revenue on a net versus gross basis (depending on an analysis of the ODO's involvement as either principal or agent)
Note 4	Purchases and other expenses	Provision for claims and litigation: assumptions underlying legal assessment and risk measurement
Note 6	Property, plant and equipment, intangible assets	Assessment of assets' useful life based on assessment of the technological, legal or economic environments
Note 7	Income tax	Assumptions used for the computation of the income tax charge to be recorded in the financial statements, together with the technical merit of tax positions Assumptions used for recognition of deferred tax assets arising

Note 2—Accounting policies

2.1 Financial statements preparation principle

Presentation

Income statement

Expenses are presented in the income statement based on their nature.

Operating income corresponds to net income before:

- finance income;
- finance costs;
- income tax (current and deferred taxes).

Orange Dominicana, S.A.
Notes to the standalone financial statements (Continued)

Note 2—Accounting policies (Continued)

Statement of financial position

Current and non-current items are presented separately in the statement of financial position: assets and liabilities with a term of no more than twelve months are classified as current whereas, assets and liabilities with a term of more than twelve months are classified as noncurrent.

Statement of cash flows

The statement of cash flows is reported using the indirect method starting with the net income and is broken down into three categories:

- cash flows arising from operating activities (including finance costs and income taxes);
- cash flows arising from investing activities (mainly purchase and disposal of intangible and tangible assets);
- cash flows arising from financing activities (dividends paid).

Foreign operations

The financial statements are expressed in Dominican pesos.

Monetary assets and liabilities in foreign currency are translated into Dominican pesos at the year-end exchange rate at the end of each reporting period and the resulting translation differences are recorded in:

- in operating income for commercial transactions;
- in finance income or finance costs for financial transactions.

Foreign operations are recorded on initial recognition at the spot exchange rate at the date of the transaction.

2.2 Revenues

Revenues

Revenues from ODO's activities are recognized as follows:

Separable components of bundled offers

Certain service offers include two components: an equipment component (e.g. a mobile handset) and a service component (e.g. a talk plan).

For the sale of multiple products or services, ODO evaluates all deliverables in the arrangement to determine whether they represent separate units of accounting. A delivered item is considered a separate unit of accounting if (i) it has value to the customer on a standalone basis and (ii) there is objective and reliable evidence of the fair value of the undelivered item(s). The total fixed or determinable amount of the arrangement is allocated to the separate units of accounting based on its relative fair value. However, when an amount allocated to a delivered item is contingent upon the delivery of additional items or meeting specified performance conditions, the amount allocated to that delivered item is limited to the non-contingent amount. This case arises when selling bundled offers that include a handset sold at a discounted price and a telecommunications service contract. The handset is considered to have value on a standalone basis to the customer, and there is objective and reliable evidence of fair value for the telecommunications service to be delivered. As the amount allocable to the handset generally exceeds the amount received from the customer at the date the handset is delivered, revenue recognized for the handset sale is generally limited to the amount of the arrangement that is not contingent upon the rendering of telecommunication services, i.e. the amount paid by the customer for the handset.

Orange Dominicana, S.A.
Notes to the standalone financial statements (Continued)

Note 2—Accounting policies (Continued)

For offers that cannot be separated into identifiable components, revenues are recognized in full over the life of the contract. The main example is connection to the service: this does not represent a separately identifiable transaction from the subscription and communications, and connection fees are therefore recognized over the average expected life of the contractual relationship.

Equipment sales

Revenues from mobile sales are recognized when the significant risks and rewards of ownership are transferred to the buyer.

When equipment—associated to the subscription of telecommunication services—is sold by a third party retailer who purchases it from ODO and receives a commission for signing up the customer, the related revenue is:

- recognized when the equipment is sold to the end-customer;
- measured by ODO taking into account the best estimate of the retail price and any subsidies granted to the retailer at the time of the sale and passed on to the end-customer in the form of a rebate on the equipment

Service revenues

Considerations from telephone service are recognized in revenue on a straight-line basis over the subscription period.

Revenue for airtime usage and messaging by customers is recognized as services are performed, with unbilled revenue resulting from services already provided accrued at the end of each period and unearned revenue from services to be provided in future periods deferred. Revenue from the sale of prepaid credit is deferred until such time as the customer uses the airtime, or the credit expires.

Loyalty programs

Points awarded to customers are treated as a separable component to be delivered in the transaction that triggered the acquisition of points. Part of the invoiced revenue is allocated to these points based on their fair value taking into account an estimated utilization rate, and deferred until the date at which the points are definitively converted into benefits. Fair value is defined as the excess price over the sales incentive that would be granted to any new customer. This principle is applied for both types of loyalty programs that exist within ODO, those with and those without a contractual renewal obligation.

Trade receivables

The trade receivables are mainly short-term, bearing no interest rate and measured at original invoice amount.

The valuation allowance on trade receivables is determined as follows:

- for mobile telephone services: the allowance is computed based on expected loss rates depending upon their aging. These rates are reviewed and adjusted periodically. When a client is determined to be in bankruptcy or subject to equivalent judicial proceedings, the associated receivables are then excluded from the statistical database and individually written-off;
- for dealers, wholesalers, interconnection (local and roaming) and carriers: the impairment loss is determined on a case by case analysis based on the ODO's experience.

Orange Dominicana, S.A.
Notes to the standalone financial statements (Continued)

Note 2—Accounting policies (Continued)

2.3 Purchases and operating expenses

Subscriber acquisition and retention costs

Subscriber acquisition and retention costs, other than loyalty programs costs, are recognized as an expense for the period in which they are incurred.

Advertising and sponsoring costs

Advertising, promotion, sponsoring, communications and brand marketing costs are expensed as incurred.

Inventories

The inventories comprise mainly mobile handsets either located in ODO's premises or at distributors until the customer service activation.

The inventories are stated at the lower of cost or net realizable value taking into account expected revenues from the sales of mobile phones. Cost corresponds to purchase cost determined using the weighted average cost method.

Trade payables

Payables are recorded at their nominal value

Provisions and contingent liabilities

Provisions

In the ordinary course of business, ODO is involved in certain legal and arbitration proceedings and administrative actions.

The costs which may result from these proceedings are accrued when ODO has a present obligation towards a third party and it is probable that an outflow of resources embodying economic benefits will be required to settle the obligation and the amount of that liability can be quantified or estimated within a reasonable range. The amount of provision recorded is based on a case-by-case assessment of the risk level, and events arising during the course of legal proceedings may require a reassessment of this risk.

Contingent liabilities

Contingent liabilities are:

- possible obligations that are not recognized because their existence will be confirmed only by the occurrence or non-occurrence of one or more uncertain future events not wholly within ODO's control; or
- present obligations arising from past events that are not recognized because it is not probable that an outflow of resources embodying economic benefits will be required to settle the obligation or because the amount of the obligation cannot be measured with sufficient reliability.

2.4 Employee benefits

Labor costs are expensed as incurred including social costs contributed by the Company in accordance with the law 87-01.

Employees are not provided with postemployment benefits.

Orange Dominicana, S.A.
Notes to the standalone financial statements (Continued)

Note 2—Accounting policies (Continued)

2.5 Intangible assets, property, plant and equipment

Intangible assets

Intangible assets comprise mainly licenses for software and international telecommunication, frequency rights and Indefeasible Rights of Use (IRUs).

IRUs acquired by ODO correspond to the right to use cable or capacity transmission cable granted for a fixed period. They are recognized as an asset when ODO has the specific indefeasible right to use an identified portion of the underlying asset, generally optical fibers or dedicated wavelength bandwidth, and the duration of the right is for the major part of the underlying asset's economic life.

Property, plant and equipment

Property, plant and equipment comprised mainly network equipment.

The gross value of tangible assets corresponds to their acquisition or production cost, including costs directly attributable to bringing the asset to the location and condition necessary for it to be capable of operating in the manner intended by management.

Due to 2004 and 2005 hyperinflation in Dominican Republic, ODO restated its 2004 and 2005 financial statements applying IAS 29 Financial Reporting in Hyperinflationary Economies and adjusted consequently the gross value of assets with the corresponding balance within Shareholders' equity (i.e. Hyperinflation reserve).

The cost of networks includes design and construction costs. Maintenance and repair costs are expensed as incurred, except where they increase the asset's productivity or extend its useful life.

Depreciation

Assets are depreciated, generally with no residual value, on a basis that reflects the pattern in which their future economic benefits are expected to be consumed. The straight-line basis is usually applied. The useful lives are reviewed annually and are adjusted if current estimated useful lives differ from previous estimates: these changes in accounting estimates are recognized prospectively.

<u>Main assets categories</u>	<u>Useful life (in years)</u>
Licences	3 - 5
Frequencies	10 - 15
IRU (Indefeasible rights of use)	10 - 15
Buildings	30
Antennas and technical equipment (sites)	8 - 28
Other technical equipment	3 - 8
Office material and software	3 - 5
Office furniture and equipment	5 - 10
Leasehold improvements	10

Dismantling

ODO is required to dismantle equipment and restore sites.

The provision is based on dismantling costs (on a per-unit basis for telephone poles, terminals and public phones, and on a per-site basis for mobile antennae) incurred by ODO to meet its environmental commitments and annual estimated asset dismantling and site restorations. The provision is assessed on the basis of the identified costs for the current financial year, extrapolated for future years using the best estimate of the commitment settlement. It is discounted at a risk-free rate. This estimate is revised annually and adjusted where appropriate against the asset to which it relates.

Orange Dominicana, S.A.
Notes to the standalone financial statements (Continued)

Note 2—Accounting policies (Continued)

2.6 Income tax

Current tax is measured by ODO at the amount expected to be paid or recovered from the taxation authorities, based on its interpretation with regard to the application of tax legislation.

Deferred taxes are recognized for all temporary differences between the book values of assets and liabilities and their tax basis, using the liability method. Deferred tax assets are recognized only when their recovery is considered probable.

Deferred tax assets and liabilities are not discounted.

At reporting period end, ODO reviews the recoverable amount of the deferred tax assets.

In accordance with these principles, ODO calculates the tax assets, liabilities and accruals recognized in the statement of financial position based on the technical merits of the positions it defends versus that of the tax authorities.

Deferred tax assets and liabilities are measured at the expected tax rates for the year during which the assets will be realized and the liabilities settled on the basis of tax rates in force or substantially in force at the period end.

2.7 Cash and cash equivalents

Cash and cash equivalents comprise cash on hand and cash at banks as well as short-term investments with an original maturity of three months or less from the date of acquisition.

Note 3—Sales

3.1 Revenues

Revenues	2012	2011
	(in thousand Dominican pesos)	
Mobile	19,436,051	18,820,409
Wholesale	1,662,446	1,729,426
Internet	507,036	351,824
Equipment	866,134	977,656
Other	282,707	304,674
Revenues	<u>22,754,374</u>	<u>22,183,989</u>

3.2 Trade receivables

Trade receivables	2012	2011
	(in Dominican pesos)	
Customers (gross)	3,058,316,537	2,966,998,426
Provision for doubtful accounts	(487,534,820)	(455,235,124)
Customers (net of provision)	<u>2,570,781,717</u>	<u>2,511,763,302</u>

The aging balance of gross trade receivables is as follows:

Customers (gross)	2012	2011
	(in Dominican pesos)	
Not due or less than 30 days	1,884,738,022	1,698,317,346
Between 30 and 60 days	654,176,575	744,877,784
Between 60 and 90 days	181,345,679	208,275,360
More than 90 days	338,056,261	315,527,936
Revenues	<u>3,058,316,537</u>	<u>2,966,998,426</u>

Orange Dominicana, S.A.
Notes to the standalone financial statements (Continued)

Note 3—Sales (Continued)

3.3 Other receivables

Other receivables	2012	2011
	(in Dominican pesos)	
Advances to suppliers	296,156,659	367,033,548
VAT	158,393,560	183,553,810
Cash pooling—current account	135,623,414	33,157,227
Others	39,281,085	43,072,668
Total	<u>629,454,718</u>	<u>626,817,253</u>

3.4 Deferred income

Deferred income	2012	2011
	(in Dominican pesos)	
Prepaid telephone cards	768,069,643	798,076,352
Loyalty program	511,072,839	528,072,839
Monthly fee	130,045,686	156,357,506
Handsets	237,384,310	129,344,806
Sim & Kit	68,415,159	61,488,918
Total	<u>1,714,987,638</u>	<u>1,673,340,422</u>

Note 4—Purchases and other expenses

4.1 Cost of equipment sold

The costs of equipment sold comprise purchases of handsets and other Sim and phone cards, as well as all costs directly attributable to them (mainly import duties and freight charges).

Cost of equipment sold	2012	2011
	(in Dominican pesos)	
Terminals	2,691,685,132	2,995,259,870
SIM cards	134,380,975	160,659,833
Import duties and freight costs	123,264,823	135,181,721
Phone cards	50,750,362	73,841,184
Accessories	(168,291)	5,293,548
Other	196,166	(5,088)
Total	<u>3,000,109,167</u>	<u>3,370,231,069</u>

4.2 Selling, distribution and traffic costs

Selling, distribution and traffic costs	2012	2011
	(in Dominican pesos)	
Selling and distribution costs	2,181,628,470	2,279,184,762
National voice mobile terminations	1,766,511,266	1,835,171,015
National voice fixed line terminations	222,273,638	182,577,887
International terminations	497,571,059	467,727,888
Data terminations (SMS)	215,589,932	219,120,848
International roaming	76,658,280	95,913,747
Other	900,958,905	819,509,031
Total	<u>5,861,191,549</u>	<u>5,899,205,178</u>

Orange Dominicana, S.A.
Notes to the standalone financial statements (Continued)

Note 4—Purchases and other expenses (Continued)

4.3 Others

<u>Other costs and income</u>	<u>2012</u>	<u>2011</u>
	(in Dominican pesos)	
Other income	127,281,750	197,485,171
Purchase of services	(453,543,414)	(381,759,212)
Network energy	(432,777,929)	(380,859,081)
Consulting, contractors & prof. serv.	(309,892,025)	(300,352,526)
Bad debt expense	(212,931,032)	(150,677,752)
IT expenses	(178,198,199)	(154,500,762)
Temporary staff/interim net ^(a)	(78,477,569)	(97,732,906)
Purchases of supplies	(137,730,818)	(126,324,827)
Operating tax	(137,062,235)	(143,214,269)
Other	(759,181,779)	(437,118,274)
Total	<u>(2,572,513,250)</u>	<u>(1,975,054,438)</u>

(a) The temporary labor expenses attributable to the network development are net of costs capitalized (RD\$ 71,335,720 and RD\$ 41,264,818, respectively for 2012 and 2011).

4.4 Inventories

<u>Inventories (net)</u>	<u>2012</u>	<u>2011</u>
	(in Dominican pesos)	
ODO's warehouse	572,890,663	752,394,474
ODO's distributors (dealers)	310,070,460	235,219,703
Total	<u>882,961,123</u>	<u>987,614,178</u>

4.5 Trade payables

<u>Trade payable</u>	<u>2012</u>	<u>2011</u>
	(in Dominican pesos)	
Fixed assets and operating suppliers	3,044,652,663	2,714,255,359
Merchandises suppliers	540,481,470	720,110,475
Related companies (see note 11)	314,449,212	506,839,042
Distributors (dealers)	229,265,172	316,863,286
Others	9,176,095	363,331,823
Total	<u>4,138,024,612</u>	<u>4,621,399,985</u>

4.6 Other current liabilities

<u>Other current liabilities</u>	<u>2012</u>	<u>2011</u>
	(in Dominican pesos)	
Taxes and VAT	455,803,544	509,329,982
Staff bonuses	213,293,577	203,296,978
Vacations and other	28,631,492	21,969,136
Total	<u>697,728,613</u>	<u>734,596,096</u>

Orange Dominicana, S.A.
Notes to the standalone financial statements (Continued)

Note 5—Labor expenses

<u>Labor expenses</u>	2012	2011
	(in Dominican pesos)	
Salaries and wages	758,861,075	663,868,224
Employee profit sharing	167,749,604	163,120,309
Social contribution	143,296,628	131,902,106
Other	104,821,663	102,408,807
Total	1,174,728,970	1,061,299,445

The labor expenses attributable to the network development have been capitalized in 2012 and 2011, for RD\$266,039,069 and RD\$292,084,111 respectively.

Note 6—Intangible assets, property, plant and equipment

6.1 Intangible assets

<u>Intangible assets</u>	2012				2011
	Frequencies	Software licenses & IRU	Right of use corporate solutions	Total	
	(in Dominican pesos)				
Gross value (opening balance) . . .	1,188,849,360	3,480,175,483	113,085,520	4,782,110,363	4,080,480,827
Acquisitions	3,827,587	672,451,456	19,767,444	696,046,488	703,448,586
Disposals	—	(14,352,199)	—	(14,352,199)	(1,149,249)
Reallocations	—	(43,618,668)	—	(43,618,668)	(669,801)
Gross value (closing balance) . . .	1,192,676,947	4,094,656,073	132,852,964	5,420,185,983	4,782,110,363
Depreciation (opening balance) . . .	(485,284,295)	(1,993,330,005)	(55,861,583)	(2,534,475,883)	(1,847,464,480)
Depreciation expense	(108,039,906)	(546,298,310)	(34,035,134)	(688,373,350)	(688,279,238)
Disposals	—	14,352,199	—	14,352,199	1,149,249
Reallocation	—	—	—	—	118,585
Depreciation (closing balance) . . .	(593,324,201)	(2,525,276,116)	(89,896,717)	(3,208,497,035)	(2,534,475,883)
Net total value	599,352,746	1,569,379,956	42,956,247	2,211,688,949	2,247,634,479

6.2 Plant, property and equipment

<u>Plant, property and equipment</u>	2012					Total	2011
	Lands	Buildings	Network and transition equipment	IT infrastructure	Others		
	(in Dominican pesos)						
Gross value (opening balance)	157,705,194	1,532,467,464	23,526,966,922	1,847,467,428	164,587,060	27,229,194,068	24,207,301,424
Acquisition	1,078,785	190,743,505	2,385,800,052	339,294,050	24,152,431	2,941,068,823	2,998,676,625
Disposals	—	(2,540,496)	(66,541,612)	(22,364,483)	—	(91,446,590)	(105,763,769)
Reallocations	—	—	(85,449,498)	(4,704,924)	—	(90,154,421)	128,979,787
Gross value (closing balance)	158,783,979	1,720,670,474	25,760,775,864	2,159,692,072	188,739,491	29,988,661,879	27,229,194,067
Depreciation (opening balance)	—	(625,395,394)	(11,358,045,050)	(1,323,052,269)	(78,501,658)	(13,384,994,371)	(10,810,256,183)
Depreciation expense	—	(191,184,156)	(2,378,353,041)	(228,766,800)	(22,527,631)	(2,820,831,628)	(2,666,381,537)
Disposals	—	2,510,103	65,987,577	22,187,645	—	90,685,324	105,763,769
Reallocation	—	—	—	—	—	—	(14,120,420)
Depreciation (closing balance)	—	(814,069,448)	(13,670,410,515)	(1,529,631,424)	(101,029,288)	(16,115,140,675)	(13,384,994,371)
Net total value	158,783,979	906,601,026	12,090,365,349	630,060,648	87,710,203	13,873,521,205	13,844,199,696

Orange Dominicana, S.A.
Notes to the standalone financial statements (Continued)

Note 6—Intangible assets, property, plant and equipment (Continued)

6.3 Non-current liabilities

<u>Non-current liabilities</u>	<u>2012</u>	<u>2011</u>
	(in Dominican pesos)	
Customer deposit	203,084,345	215,088,579
Provisions	343,923,698	273,004,686
ARO provisions	97,667,735	129,922,770
Total	<u>644,675,778</u>	<u>618,016,036</u>

Note 7—Income tax

7.1 Income tax charge

<u>Income tax</u>	<u>2012</u>	<u>2011</u>
	(in Dominican pesos)	
Current income tax	1,462,560,893	1,306,410,817
Deferred income tax	(332,500,700)	(413,429,415)
Dividends credits	(329,753,087)	(874,803,000)
Tax credit from Law 97-2007 incentives	(10,375,358)	(10,375,358)
Total	<u>789,931,748</u>	<u>7,803,044</u>

7.2 Tax proof

<u>Tax proof</u>	<u>2012</u>	<u>2011</u>
	(in Dominican pesos)	
Profit before income tax	4,236,199,291	4,133,030,444
29% Income tax rate on profit before income tax	1,228,497,795	1,198,578,829
Tax effect of:		
Dividends credits	(329,753,087)	(874,803,000)
Impact of assets annual reevaluation for tax purpose (inflation) . . .	(168,732,345)	(251,895,805)
Effect of change in tax rate on deferred income tax	(46,475,938)	(54,323,859)
Adjustment to current tax of prior year	63,714,428	2,124,401
Other	42,680,895	(11,877,522)
Effective income tax	<u>789,931,748</u>	<u>7,803,044</u>
Effective tax rate	18.6%	0.2%

7.3 Income tax receivable

<u>Income tax</u>	<u>2012</u>	<u>2011</u>
	(in Dominican pesos)	
Advances of the period	497,442,249	1,281,709,849
Prior year tax credit carry forward	796,762,816	—
Tax credit from Law 97-2007 incentives	10,387,949	10,375,358
Credit arising from dividends withholdings	329,753,087	874,803,000
Adjustment to previous year tax	—	(2,124,401)
Current tax provision	(1,398,846,464)	(1,304,031,071)
Others	—	(255,338)
Total	<u>235,499,637</u>	<u>860,477,397</u>

Orange Dominicana, S.A.

Notes to the standalone financial statements (Continued)

Note 7—Income tax (Continued)

7.4 Deferred income tax

	2012		2011	
	Balance Sheet	Income Statement	Balance Sheet	Income Statement
Deferred income tax				
		(in Dominican pesos)		
Provision for loyalty Program	137,989,667	15,151,457	153,141,122	(30,813,196)
Depreciable fixed assets	1,100,895,733	(257,394,884)	843,500,849	(268,181,067)
Provision for bad debts	147,833,913	(14,097,955)	133,735,958	(27,675,400)
Provision inventory obsolescence	21,801,449	(774,224)	21,027,225	10,120,454
Other provisions	325,335,006	(77,268,838)	248,066,168	(66,175,285)
Vacations and incentives provision	9,711,281	1,119,279	10,830,560	(3,751,988)
Deferred revenues/cost	1,878,678	(10,349,938)		
Exchange difference	—	1,554,733	587,613	(587,613)
Deferred tax assets	1,745,445,727	(342,060,370)	1,410,889,495	(387,064,095)
Deferred tax liabilities				
Exchange difference	(967,120)	—	—	(471,817)
Deferred revenues/costs	—	—	(8,471,260)	(2,582,493)
Effect of IAS29 adjustment	(122,329,447)	9,559,672	(112,769,775)	(23,311,010)
Deferred tax liabilities	(123,296,566)	9,559,672	(121,241,035)	(26,365,320)
Net deferred tax	1,622,149,160	(332,500,699)	1,289,648,460	(413,429,415)

The Law No.309-12 was enacted on December 7, 2012, with the objective of granting the possibility of a tax amnesty to tax payers regarding the following taxes: income tax, value added tax, asset tax, transfer tax, inheritance tax, property taxes and customs taxes. The main benefits of the tax amnesty include closing fiscal periods up to 2011 for tax audit purposes; waive of penalties regarding existing tax liabilities, including those appealed by the tax payer. Orange did not apply for the tax amnesty.

Note 8—Cash and cash equivalents

<u>Cash and cash equivalents</u>	2012	2011
	(in Dominican pesos)	
Cash on hand	944,811	1,901,350
Cash at banks	1,158,645,957	1,142,755,184
Total	1,159,590,768	1,144,656,534

Note 9—Equity

9.1 Share capital

The shareholders' meeting decided the conversion of the retained earnings into share capital on December 19, 2012. The share capital therefore, increased by 38,000,000 shares, and is now made of 58,000,000 shares each at a par value of RD\$100. There are no outstanding shares as of December 31, 2012.

9.2 Legal reserve

In accordance with the article 58 of the commercial Code of the Dominican Republic, the legal reserve is annually contributed by 5% of the net income until the total amount equals 10% of paid-in capital. This reserve cannot be capitalized, transferred to retained earnings or to use to pay dividends.

Orange Dominicana, S.A.
Notes to the standalone financial statements (Continued)

Note 9—Equity (Continued)

9.3 Dividends

ODO's shareholders meeting approved the payment of dividends in April, September and November 2012 for a total amount of RD\$469,320,000; 667,760,000 and RD\$2,207,700,000 respectively.

The Tax Reform Act, No. 253-12, enacted on November 9, 2012 establishes a 10% withholding tax on dividends due by the distributing entity. This new act supersedes the prior regime that consisted in a 29% withholding tax on dividends, which was subsequently refunded as a tax credit to the distributing entity, in the same fiscal period. The dividends paid in April and September 2012 were taxed under the former regime.

Note 10—Foreign currency

ODO is exposed to foreign exchange risk due both to its revenues and purchases denominated in US dollars and euros. As a consequence, these foreign operations have a direct effect on the operating, finance income and the trade receivables and payables.

Breakdown by currency

	2012	2011
	(in Dominican pesos)	
Revenues		
DOP	16,471,989,318	15,771,264,887
EUR	265,314,558	310,906,548
USD	6,017,069,386	6,101,817,717
Multi currencies (Gas & Electricity)	242	—
Total	<u>22,754,373,505</u>	<u>22,183,989,151</u>
Operating expenses		
DOP	(5,829,181,877)	(5,296,843,738)
EUR	(1,077,968,440)	(1,095,284,532)
USD	(7,581,584,880)	(7,842,386,587)
Multi currencies (Gas & Electricity)	(535,393,613)	(477,278,963)
Total	<u>(15,024,128,810)</u>	<u>(14,711,793,820)</u>
Capex		
DOP	(1,533,906,442)	(1,714,898,981)
EUR	(901,068,402)	(683,153,573)
USD	(1,202,140,466)	(1,304,072,658)
Total	<u>(3,637,115,310)</u>	<u>(3,702,125,212)</u>

Orange Dominicana, S.A.
Notes to the standalone financial statements (Continued)

Note 11—Related parties transactions

ODO's financial position and income statement elements with Orange SA and its subsidiaries is detailed below:

<u>Related parties transactions</u>	<u>2012</u>	<u>2011</u>
	(in Dominican pesos)	
Statement of financial position		
Accounts receivable	29,223,556	32,674,022
Cash pooling—current account ^(a)	135,623,414	33,157,227
Accounts payable	(314,449,212)	(506,839,042)
Income statement		
Revenue (Traffic, interconnection and other income)	218,902,968	161,468,498
Selling, distribution and traffic costs	(66,186,205)	(67,159,342)
Brand fees ^(b)	(351,549,524)	(336,388,654)
Corporate management fees ^(c)	(231,146,089)	(243,777,326)
General maintenance and services	(9,896,989)	(8,221,594)
Other operating expenses, net	(102,414,970)	(100,489,891)
Other operating income	12,636,008	—

(a) In February 2009, Orange SA and ODO signed a centralized treasury management agreement (CTMA). Orange S.A. thus optimizes the Group liquidity. ODO lends or borrows its cash surplus/needs through a current account with Orange SA. The cash pooling accounts bear interest which is calculated on a daily balance and on a daily basis using:

- for the EUR account: EONIA rate for a credit balance and EONIA plus 2.15% margin for a debit balance
- for the USD account: LIBOR Overnight rate for a credit balance and LIBOR Overnight plus 2.15% margin for a debit balance

(b) The utilization of the Orange brand name is defined in a brand license agreement signed with Orange Group and costs a 1.6% fee of the ODO's monthly operating revenue.

(c) Management fees are determined in accordance with an agreement signed with Orange SA and are charged using a 1.03% on the monthly contributive operational revenue in 2012.

Note 12—Unrecognized contractual commitments

12.1 Leasing commitments

<u>Rental commitments by year of expiration</u>	<u><1 year</u>	<u>1 - 5 years</u>	<u>over 5 years</u>	<u>Total</u>
	(in Dominican pesos)			
Total	474,094,831	1,100,473,583	400,133,861	1,974,702,275

The Company enters into operating lease agreements in its ordinary course of business (mainly commercial offices and antennas sites).

12.2 Other purchase and investment commitments

<u>Other purchase and investment commitments</u>	<u>2012</u>
	(in Dominican pesos)
Other opex commitments	458,756,888
Cap ex commitments	965,744,919
Handset purchase commitments	631,578,716

- Other opex commitment are relating to marketing, network, gas distribution and civil engineering.
- Capital expenditures mainly related to network projects.

Orange Dominicana, S.A.
Notes to the standalone financial statements (Continued)

Note 13—Litigation

As of December 31, 2012, ODO is party to certain judicial procedures with former distributors or dealers, for which no provision is recorded as ODO considers at this stage of the procedure that the claims are without merit.

Note 14—Subsequent events

None.

PT Comunicações
Financial Statements

PT COMUNICAÇÕES, S.A.
BALANCE SHEETS
30 SEPTEMBER 2014 AND 31 DECEMBER 2013

	Notes	30 Sep 2014	31 Dec 2013
Euro			
ASSETS			
Non-current assets			
Tangible fixed assets	4	2,534,722,664	2,687,744,235
Investment properties		7,782,618	12,987,051
Goodwill		2,982,442,403	2,982,442,403
Intangible assets	4	192,824,177	212,789,378
Financial investments—equity method of accounting	5	7,037,119,315	6,920,678,140
Financial investments—other methods		1,219,919	1,224,907
Post retirement benefits	10	1,935,052	1,834,000
Other financial assets		14,135,259	4,077,850
Deferred tax assets	6	316,101,351	311,535,642
Total non-current assets		13,088,282,758	13,135,313,606
Current assets			
Inventories		31,805,203	30,711,476
Accounts receivable—trade	7	456,528,763	461,531,564
Unbilled revenues	7	83,452,667	88,412,138
Advances to suppliers		3,953,585	6,292,151
Shareholders and group companies		22,710,933	—
Other accounts receivable		104,899,761	123,456,398
Deferrals		12,867,979	16,020,983
Non-current assets held for sale		—	4,653,742
Cash and bank deposits	3	54,887,613	21,737,013
Total current assets		771,106,504	752,815,465
Total assets		13,859,389,262	13,888,129,071
SHAREHOLDERS' EQUITY			
Share capital		1,150,000,000	1,150,000,000
Other shareholders' equity instruments		4,350,466,191	4,350,466,191
Legal reserve		30,000,000	30,000,000
Other reserves		(13,232,464)	178,133,162
Adjustments to financial assets		724,047,283	(745,613,034)
Revaluation surplus		567,494,032	567,494,032
Other shareholders' equity variations		1,829,155	3,373,856
Retained earnings		(1,216,396,278)	(670,079,540)
Net loss		(1,256,489,779)	(210,225,304)
Total shareholders' equity		4,337,718,140	4,653,549,363
LIABILITIES			
Non-current liabilities			
Provisions	8	412,691	400,260
Loans obtained	9	7,302,077,483	6,877,406,946
Post retirement benefits	10	1,065,679,631	943,799,639
Deferred tax liabilities	6	141,490,029	148,603,529
Other financial liabilities		100,000	143,238
Total non-current liabilities		8,509,759,834	7,970,353,612
Current liabilities			
Provisions	8	25,347,049	12,570,313
Loans obtained	9	15,898,343	362,899,051
Deferrals		94,075,782	92,590,506
Accounts payable to group companies		299,829	3,202,808
Suppliers	11	455,844,047	345,121,314
Investment suppliers	11	33,087,230	100,127,368
Accrued expenses	12	283,388,987	293,304,820
Advances from accounts receivable		6,464,092	6,645,294
State and other public entities		40,905,562	18,982,227
Other accounts payable		56,600,367	28,782,395
Total current liabilities		1,011,911,288	1,264,226,096
Total liabilities		9,521,671,122	9,234,579,708
Total liabilities and shareholders' equity		13,859,389,262	13,888,129,071

The accompanying notes form an integral part of these financial statements.

Accountant

The Board of Directors

PT COMUNICAÇÕES, S.A.
INCOME STATEMENTS
FOR THE NINE-MONTH PERÍODS ENDED 30 SEPTEMBER 2014 AND 2013

	Notes	9M14	9M13
		Euro	
Services rendered	13	1,251,617,076	1,265,652,128
Sales	13	17,977,131	13,283,358
Subsidies to operation		232,569	41,993
Production variation		752,726	1,615,411
Equity in earnings of affiliated companies, net	14	(1,021,321,598)	161,327,423
Own work capitalized		33,864,312	36,160,905
Costs of products sold		(17,582,360)	(15,223,088)
Direct costs	15	(372,186,261)	(368,114,629)
Marketing and publicity		(14,525,404)	(18,922,857)
Supplies and external services	16	(318,852,250)	(314,169,810)
Wages and salaries	17	(176,152,295)	(174,285,948)
Post retirement benefit costs	10	(31,209,555)	(31,663,401)
Curtailment and settlement costs	10	21,877,502	(102,290,091)
Indirect taxes		(12,048,207)	(11,483,096)
Impairment of inventories ((losses)/reversals)		1,995,624	218,205
Impairment of accounts receivable ((losses)/reversals)	7	(12,184,504)	(11,188,604)
Provisions (increases/reductions)	8	(580,032)	5,197,259
Other income and gains		68,573,864	80,169,684
Other expenses and losses		(17,868,999)	(26,824,127)
INCOME BEFORE DEPRECIATION AND AMORTISATION, FINANCING EXPENSES AND TAXES		(597,620,661)	489,500,715
Depreciation and amortisation ((losses)/reversals)	4	(329,457,276)	(360,284,112)
OPERATING INCOME (BEFORE FINANCING EXPENSES AND TAXES)		(927,077,937)	129,216,603
Interest and related income	18	2,668,727	4,735,275
Interest and related expenses	18	(285,340,584)	(275,642,999)
INCOME BEFORE TAXES		(1,209,749,794)	(141,691,121)
Income taxes	6	(46,739,985)	2,548,689
NET LOSS		(1,256,489,779)	(139,142,432)
Basic earnings per share	19	(1.09)	(0.12)

The accompanying notes form an integral part of these financial statements.

Accountant

The Board of Directors

PT COMUNICAÇÕES, S.A.
STATEMENTS OF CHANGES IN SHAREHOLDERS' EQUITY
FOR THE NINE-MONTH PERÍODS ENDED 30 SEPTEMBER 2014 AND

		Share capital	Other shareholders' equity instruments	Legal reserve	Other reserves	Adjustment to financial assets	Revaluation surplus
Euro							
Balance as at 1 January 2013	A	1,150,000,000	4,350,466,191	30,000,000	295,771,223	(456,822,242)	589,044,034
Changes:							
Unpaid dividends		—	—	—	—	250,646,251	—
Deferred taxes adjustments		—	—	—	—	182,856	—
Effect of disposals of subsidiaries		—	—	—	—	—	—
Recognition of investments subsidies		—	—	—	—	—	—
Actuarial losses recognised in the year		—	—	—	(10,154,596)	—	—
Foreign currency translation adjustments		—	—	—	—	(343,354,986)	—
Other changes in shareholders' equity		—	—	—	—	(6,209,465)	—
	B	—	—	—	(10,154,596)	(98,735,344)	—
Net loss	C						
Comprehensive income	B+C						
Operations with shareholders:							
Application of earnings		—	—	—	—	—	—
	D	—	—	—	—	—	—
Balance as at 30 September 2013	E=A+B+C+D	1,150,000,000	4,350,466,191	30,000,000	285,616,627	(555,557,586)	589,044,034

The accompanying notes form an integral part of these financial statements.

Accountant

PT COMUNICAÇÕES, S.A.
STATEMENTS OF CHANGES IN SHAREHOLDERS' EQUITY (Continued)
FOR THE NINE-MONTH PERIODS ENDED 30 SEPTEMBER 2014 AND

		Share capital	Other shareholders' equity instruments	Legal reserve	Other reserves	Adjustment to financial assets	Revaluation surplus	sh
Euro								
Balance as at 1 January 2014	F	1,150,000,000	4,350,466,191	30,000,000	178,133,162	(745,613,034)	567,494,032	—
Changes:								
Foreign currency translation adjustments		—	—	—	—	1,139,562,897	—	—
Unpaid dividends		—	—	—	—	336,091,434	—	—
Recognition of investments subsidies		—	—	—	—	—	—	—
Actuarial losses recognised in the year		—	—	—	(191,365,626)	—	—	—
Other changes in shareholders' equity		—	—	—	—	(5,994,014)	—	—
	F	—	—	—	(191,365,626)	1,469,660,317	—	—
Net loss	G							
Comprehensive income	F+G							
Operations with shareholders:								
Application of earnings		—	—	—	—	—	—	—
	H	—	—	—	—	—	—	—
Balance as at 30 September 2014	I = E+F+G+H	1,150,000,000	4,350,466,191	30,000,000	(13,232,464)	724,047,283	567,494,032	—

The accompanying notes form an integral part of these financial statements.

Accountant

PT COMUNICAÇÕES, S.A.
STATEMENTS OF CASH FLOWS
FOR THE NINE-MONTH PERÍODS ENDED 30 SEPTEMBER 2014 AND 2013

	Notes	9M14	9M13
Euro			
OPERATING ACTIVITIES			
Collections from clients		1,628,928,768	1,683,066,053
Payments to suppliers		(837,522,933)	(937,680,258)
Payments to employees		(140,898,011)	(142,121,795)
Cash flows from operations		650,507,824	603,264,000
Cash receipts (payments) relating to income taxes	3.(a)	(3,604,738)	(1,775,430)
Payments relating to post retirement benefits	10	(136,165,727)	(134,177,880)
Other cash payments, net		(26,576,474)	(70,741,875)
Cash flows from operating activities (1)		484,160,885	396,568,815
INVESTING ACTIVITIES			
Cash receipts resulting from:			
Tangible fixed assets	3.(b)	49,582,012	5,145,755
Intangible assets		—	9,379
Financial investments	3.(c)	174,056	35,966,391
Loans granted	3.(d)	5,677,520	340,000,000
Interest and related income		2,069,387	1,690,270
Dividends	3.(e)	235,706	2,703,029
		57,738,681	385,514,824
Payments resulting from:			
Tangible fixed assets		(258,225,299)	(307,435,678)
Intangible assets		(4,678,796)	(7,467,275)
Financial investments	3.(f)	(2,983,728)	(175,000)
Loans granted		(10,414,000)	(8,200,000)
		(276,301,823)	(323,277,953)
Cash flows from investing activities (2)		(218,563,142)	62,236,871
FINANCING ACTIVITIES			
Cash receipts resulting from:			
Loans obtained	3.(g)	2,558,350,000	365,330,837
Subsidies		335,741	387,868
		2,558,685,741	365,718,705
Payments resulting from:			
Loans repaid	3.(g)	(2,488,714,833)	(603,686,517)
Interest and related expenses		(303,129,081)	(191,530,537)
		(2,791,843,914)	(795,217,054)
Cash flows from financing activities (3)		(233,158,173)	(429,498,349)
Change in cash and cash equivalents (4) = (1) + (2) + (3)		32,439,570	29,307,337
Effect of exchange differences		711,030	(987,214)
Cash and cash equivalents at the beginning of the period		21,737,013	21,165,981
Cash and cash equivalents at the end of the period	3.(h)	54,887,613	49,486,104

The accompanying notes form an integral part of these financial statements.

Accountant

The Board of Directors

INDEX

1.	Introduction	F-287
2.	Basis of presentation	F-287
3.	Cash flows	F-288
4.	Tangible fixed assets and Intangible assets	F-290
5.	Financial investments-equity method of accounting	F-291
6.	Income tax	F-292
7.	Accounts receivable and unbilled revenues	F-294
8.	Provisions and contingent liabilities	F-295
9.	Loans obtained	F-298
10.	Post-retirement benefits	F-298
11.	Suppliers	F-301
12.	Accrued expenses	F-301
13.	Services rendered and sales	F-302
14.	Equity in earnings (losses) of affiliated companies	F-302
15.	Direct costs	F-303
16.	Supplies and external services	F-304
17.	Wages and salaries	F-304
18.	Interest and related income/expense	F-304
19.	Earnings per share	F-305
20.	Guarantees	F-306
21.	Events occurred after the balance sheet date	F-306

PT Comunicações
Notes to the Financial Statements
As at 30 September 2014
(Amounts stated in Euros)

1. Introduction

PT Comunicações, S.A. (“PT Comunicações” or the “Company”) was incorporated in 2000, in accordance with a resolution from the General Meeting of Portugal Telecom, S.A. on April 27, 2000 within the business restructuring process in Portugal Telecom Group and by spin-off from Portugal Telecom, S.A. The conditions for this spin-off were defined under Decree-Law no. 219/00, of September 9, and Joint Order no. 936-A/2000 issued by the Ministers for Social Provision and for Finance on September 14. On 30 September 2006, under the restructuring process of the Group Portugal Telecom, Portugal Telecom, SGPS, S.A. (“PT SGPS”) sold to PT Portugal, SGPS, S.A. (“PT Portugal”—a sub-Holding company of the Group) all of the shares of PT Comunicações.

The concession that had been granted by the Portuguese government to PT Comunicações, with an initial term expiring in 2025, was formally revoked on 1 June 2014, as from which Zon Optimus replaced the Company as the universal service provider of access to a public electronic communications network at a fixed location. Under the terms of an agreement entered into with the Portuguese Government in November 2013, the Company was entitled to a compensation for the termination of the concession agreement, which was received in September 2014, amounting to Euro 32 million.

On 5 May 2014, Portugal Telecom SGPS, S.A. (“Portugal Telecom”) subscribed a share capital increase of Oi, S.A. (“Oi”) through the contribution in kind of its 100% interest in PT Portugal SGPS, S.A. (“PT Portugal”). Following this transaction, PT Portugal became a wholly-owned subsidiary of Oi and is now the parent company of the group in Portugal, while Portugal Telecom no longer controls PT Portugal and its subsidiaries. The Company’s only shareholder continues to be PT Comunicações which in turn also continues to be a wholly-owned subsidiary of PT Portugal. Consequently, as from 5 May 2014, the Company is indirectly a wholly-owned subsidiary of Oi.

During the nine months period ended 30 September 2014, in connection with an internal corporate restructuring of PT Group for purposes of the Oi share capital increase undertaken on 5 May 2014, the following transactions involving either the company or its subsidiaries were completed:

- On 30 April 2014, PT Móveis, SGPS, S.A. (“PT Móveis”), a wholly-owned subsidiary of Meo, S.A., subscribed a share capital increase of Bratel BV by an amount of Euro 1,303 million;
- On 2 May 2014, PT Móveis disposed to Portugal Telecom, for an amount of Euro 4,195 million its 100% interest in Bratel BV, the company that held the investment in Oi, indirectly through Bratel Brasil, S.A. (“Bratel Brasil”). This operation generate a net loss of Euro 950 million recorded by PT Móveis which includes, (1) a capital gain of Euro 50 million reflecting the difference between the selling price (Euro 4,195 million) and the carrying value of the investment in Bratel BV (Euro 4,145 million) and (2) the transfer to net income of the cumulative amount of negative foreign currency translation adjustments that were recorded directly in shareholders’ equity between March 2011 (Oi’s acquisition date) and 2 May 2014, in the amount of Euro 950 million;
- On 2 May 2014, Portugal Telecom disposed to PT Móveis, for a total amount of Euro 2.240 million, its 100% interest in PT Participações, SGPS, S.A., the company that held, indirectly, a 75% interest in Africatel Holdings BV.

2. Basis of presentation

These financial statements were prepared in accordance with Portuguese legislation, based on Decree-law nº. 158/2009, which approved the new Portuguese accounting system, named Sistema de Normalização Contabilística (“SNC”), including the conceptual structure, Normas Contabilísticas e de Relato Financeiro (“NCRF”) and Interpretative Standards, as approved by Notices nº 15652/2009, 15655/2009 and 15653/2009, respectively. As permitted by Decree-Law nº. 158/2009, the Company also applies the International Financial Reporting Standards (“IAS/IFRS”) and related interpretations (“SIC/IFRIC”) issued by International Accounting Standards Board (IASB), in order to fill in the gaps or omissions in SNC regarding specific situations of certain transactions.

PT Comunicações
Notes to the Financial Statements (Continued)
As at 30 September 2014
(Amounts stated in Euros)

2. Basis of presentation (Continued)

As the Portuguese accounting system does not cover interim financial reporting, these interim financial statements have been presented in accordance with IAS 34 Interim Financial Reporting (“IAS 34”) and therefore do not include all the information required by above mentioned Portuguese accounting system. Accordingly, these interim financial statements should be read in conjunction with the financial statements for the year ended 31 December 2013.

3. Cash flows

For the purposes of the cash flow statement, the caption “Cash and cash equivalents” includes cash, bank deposits immediately available, net of bank overdrafts.

The Company is exposed to a liquidity risk if its sources of funding, including cash balance, operating cash inflows, divestments and cash flows obtained from financing operations, do not match with our financing needs, such as operating and financing outflows, investments, shareholder remuneration and debt repayments. Based on the cash flows generated by its operations, on the available cash and in the possibility to obtain financing from PT Portugal under the centralized cash management system, the Company believes that it is able to meet its obligations.

The cash flow statement was prepared in accordance with “*NCRF 2 Statement of Cash Flows*”, which includes the following:

(a) Cash receipts (payments) relating to income taxes

Under the special taxation regime for Groups of companies the Company paid to PT Portugal Euro 3,604,738 and Euro 1,775,430 in the nine-month periods ended 30 September 2014 and 2013, respectively (Note 6).

(b) Cash receipts resulting from the disposal of tangible fixed assets

The increase in this caption reflects primarily the sale of tangible fixed assets to PT Cloud e Data Centers, a group company, in connection with an internal restructuring of the group.

(c) Cash receipts resulting from the disposal of financial investments

In the nine months period ended 30 September 2013, this caption corresponds to the proceeds of Euro 35,966,391 obtained from the disposal of the 3% interest previously held in CTM.

(d) Cash receipts resulting from loans granted

This caption corresponds to repayments of Euro 5,677,520 by Fibroglobal in the nine months period ended 30 September 2014 and repayments of Euro 340,000,000 by Meo, S.A. in the nine months period ended 30 September 2013, both of which relating to loans granted by PT Comunicações to these entities in previous periods.

(e) Dividends received

In the nine-month periods ended 30 September 2014 and 2013, PT Comunicações received dividends from Multicert, amounting to Euro 235,706 (Note 5), and from CTM, amounting to Euro 2,703,029, respectively.

PT Comunicações
Notes to the Financial Statements (Continued)
As at 30 September 2014
(Amounts stated in Euros)

3. Cash flows (Continued)

(f) Payments resulting from financial investments

In the nine-month periods ended 30 September 2014 and 2013, this caption consists of:

	<u>9M14</u>	<u>9M13</u>
	Euro	
Acquisition of INESC	2,884,074	—
Acquisition of Vortal	99,654	—
Acquisition of Auto Sapo	—	175,000
	<u>2,983,728</u>	<u>175,000</u>

(g) Cash receipts (payments) related to loans obtained

In the nine-month periods ended 30 September 2014 and 2013, cash receipts from loans obtained, net of cash payments from loans obtained, has the following composition:

	<u>9M14</u>	<u>9M13</u>
	Euro	
Receipts (payments) obtained under commercial paper programmes	(2,133,350,000)	(592,000,000)
Loans granted by PT Portugal	2,558,350,000	252,000,000
Intercompany loans within centralized cash management	(342,945,004)	113,330,836
Leases and other loans obtained	(12,419,829)	(11,686,516)
	<u>69,635,167</u>	<u>(238,355,680)</u>

(h) Cash and cash equivalents

As at 30 September 2014 and 2013, this caption is composed as follows:

	<u>9M14</u>	<u>9M13</u>
	Euro	
Cash	3,098,931	1,002,375
Bank deposits immediately available	51,788,682	48,483,729
Cash and bank deposits	<u>54,887,613</u>	<u>49,486,104</u>

PT Comunicações
Notes to the Financial Statements (Continued)
As at 30 September 2014
(Amounts stated in Euros)

4. Tangible fixed assets and Intangible assets

During the nine months period ended 30 September 2014, movements in tangible fixed assets were as follows:

	Land and natural resources	Buildings and other constructions	Basic equipment	Transportation equipment	Administrative equipment	Other tangible fixed assets	Tangible fixed assets in progress	Advances to suppliers of assets	Total
Gross value									
Opening balance	176,660,561	848,736,929	9,158,390,923	45,479,934	871,660,948	56,683,488	89,438,201	562,661	11,247,613,645
Acquisitions	1,247	676,284	103,290,464	1,812,910	8,121,589	364,219	52,622,351	—	166,889,064
Disposals	—	(10,627,958)	(12,783,336)	(4,010,468)	(63,281,737)	(71)	—	—	(90,703,570)
Transfers and write-offs	1,131,737	8,295,008	(28,795,738)	(486,145)	23,606,444	(55,207)	(46,041,272)	—	(42,345,173)
Closing balance	177,793,545	847,080,263	9,220,102,313	42,796,231	840,107,244	56,992,429	96,019,280	562,661	11,281,453,966
Accumulated depreciation and impairment losses									
Opening balance	9,803,584	494,594,753	7,160,541,461	30,011,479	809,798,522	55,119,611	—	—	8,559,869,410
Depreciation of the period (Note 18)	—	19,281,931	250,002,753	3,980,130	32,195,146	372,662	—	—	305,832,622
Disposals	—	(5,834,616)	(9,260,733)	(3,585,949)	(55,626,599)	(71)	—	—	(74,307,968)
Transfers and write-offs	31,639	(984,826)	(40,907,263)	(320,699)	(2,426,405)	(55,208)	—	—	(44,662,762)
Closing balance	9,835,223	507,057,242	7,360,376,218	30,084,961	783,940,664	55,436,994	—	—	8,746,731,302
Net value	167,958,322	340,023,021	1,859,726,095	12,711,270	56,166,580	1,555,435	96,019,280	562,661	2,534,722,664

During the nine months period ended 30 September 2014, movements in intangible assets were as follows:

	Industrial property and other rights	Other intangible assets	Intangible assets in progress	Total
Gross value				
Opening balance	508,412,395	1,474,072	3,819,458	513,705,925
Acquisitions	3,310,016	19,750	474,133	3,803,899
Transfers and write-offs	2,939,151	90,000	(3,171,097)	(141,946)
Closing balance	514,661,562	1,583,822	1,122,494	517,367,878
Accumulated amortisation and impairment losses				
Opening balance	300,171,417	745,130	—	300,916,547
Amortisation	23,294,845	332,309	—	23,627,154
Closing balance	323,466,262	1,077,439	—	324,543,701
Intangible assets, net	191,195,300	506,383	1,122,494	192,824,177

Total capital expenditures for tangible fixed assets and intangible assets amounted to Euro 170.0 million in the nine months period ended 30 September 2014, reflecting investments in tangible fixed assets allocated essentially toward reinforcing the quality and expanding the coverage of the FTTH network. In the nine months period ended 30 September 2013, total capital expenditures for tangible fixed assets and intangible assets amounted to Euro 229.3 million.

PT Comunicações
Notes to the Financial Statements (Continued)
As at 30 September 2014
(Amounts stated in Euros)

4. Tangible fixed assets and Intangible assets (Continued)

In the nine-month periods ended 30 September 2014 and 2013, the composition of depreciation and amortization expenses is as follows:

	9M14	9M13
	Euro	
Tangible fixed assets	305,832,622	335,563,636
Intangible assets	23,627,154	23,616,011
Investment properties	(2,500)	1,104,465
	<u>329,457,276</u>	<u>360,284,112</u>

During the nine months period ended 30 September 2014, the following expenses were included in the carrying value of tangible assets and intangible assets in progress:

	9M14	9M13
	Euro	
Materials consumed	787,412	2,953,030
Wages and salaries	29,095,686	28,066,523
Other expenses and losses	3,981,214	5,141,352
	<u>33,864,312</u>	<u>36,160,905</u>

5. Financial investments—Equity method of accounting

During the nine months period ended 30 September 2014, the movements occurred under this caption were as follows:

	Investments in subsidiary companies	Additional paid in capital contributions to subsidiary companies	Additional paid in capital contributions to associated companies	Investments in associated companies	Loans in associated companies	Total
	Euro					
Gross value						
Opening balance	6,916,578,976	150,000	—	3,824,742	3,117,210	6,923,670,928
Reductions	(173,756)	—	—	—	(62,520)	(236,276)
Equity method	112,822,222	—	—	(562,806)	—	112,259,416
Dividends	—	—	—	(235,706)	—	(235,706)
Non current assets held for sale	—	—	22,045,934	(19,987,693)	2,595,500	4,653,741
Closing balance	<u>7,029,227,442</u>	<u>150,000</u>	<u>22,045,934</u>	<u>(16,961,463)</u>	<u>5,650,190</u>	<u>7,040,112,103</u>
Impairment losses						
Opening balance	—	—	—	2,992,788	—	2,992,788
Closing balance	<u>—</u>	<u>—</u>	<u>—</u>	<u>2,992,788</u>	<u>—</u>	<u>2,992,788</u>
Financial investments, net	<u>7,029,227,442</u>	<u>150,000</u>	<u>22,045,934</u>	<u>(19,954,251)</u>	<u>5,650,190</u>	<u>7,037,119,315</u>

In the nine months period ended 30 September 2014, the movements occurred in investments in subsidiary and associated companies resulting from the application of the equity method of accounting were recorded as follows:

	Euro	31 Dec 2013 Euro
Gains in affiliated companies net (Note 14)	(1,021,297,173)	201,666,539
Adjustments to financial assets	1,133,556,589	(541,439,013)
	<u>112,259,416</u>	<u>(339,772,474)</u>

PT Comunicações
Notes to the Financial Statements (Continued)
As at 30 September 2014
(Amounts stated in Euros)

5. Financial investments—Equity method of accounting (Continued)

In the nine months period ended 30 September 2014, Multicert paid dividends to the Company amounting to Euro 235.706 (Note 3.d).

The movements under the caption “Non-current assets held for sale” correspond to the carrying value of the investment in Sportinveste, which was classified as held for sale as at 31 December 2013 and is no longer classified as held for sale as at 30 September 2014 since the Portuguese Competition Authority rejected the business combination that supported the held for sale classification as at 31 December 2013.

6. Income tax

In 2013, companies located in mainland Portugal are subject to Corporate Income Tax at a base rate of 25%, increased (1) up to a maximum of 1.5% of taxable income through a municipal tax, and (2) by a state surcharge levied at the rate of 3.0% on taxable income between Euro 1.5 million and Euro 7.5 million and at the rate of 5.0% on taxable income in excess of Euro 7.5 million.

In 2014, companies located in mainland Portugal are subject to Corporate Income Tax at a base rate of 23%, increased (1) up to a maximum of 1.5% of taxable income through a municipal tax, and (2) by a state surcharge levied at the rates of 3.0% on taxable income between Euro 1.5 million and Euro 7.5 million, 5.0% on taxable income between Euro 7.5 million and Euro 35.0 million and 7.0% on taxable income in excess of Euro 35.0 million, resulting in a maximum aggregate tax rate of approximately 31.5% for taxable income higher than Euro 35.0 million.

As the Company reported tax losses for both nine-month periods ended 30 September 2014 and 2013, neither the 1.5% municipal tax nor the state taxes are applicable.

The Company’s income taxes are computed based on the tax rate mentioned above and are determined on the basis of profit before-tax adjusted in accordance with tax legislation.

PT Portugal has adopted the tax consolidation regime in Portugal (currently known as the Special Regime for the Taxation of Groups of Companies), under which the provision for income taxes is determined on the basis of the estimated taxable income for all the companies in which PT Portugal holds at least 75% of the share capital and that are domiciled in Portugal and subject to Corporate Income Tax (IRC). PT Portugal is still waiting for the approval from the tax authorities in relation to the use of this tax consolidation regime in 2014, since PT Portugal only became the parent company of the group in Portugal as from 5 May 2014, following the contribution in kind made by Portugal Telecom to the Oi share capital increase consisting of its 100% interest in PT Portugal (Note 1). The Company is part of the Special Taxation Regime for Groups of Companies and, as a result, the income tax estimate and deductions made by third parties are recorded on the balance sheet as accounts payable and receivable of PT Portugal.

PT Comunicações
Notes to the Financial Statements (Continued)
As at 30 September 2014
(Amounts stated in Euros)

6.1. Deferred taxes

Movements in deferred tax assets during the nine-month periods ended 30 September 2014 were as follows:

	Post retirement benefits	Impairment of accounts receivable	Depreciation and amortisation of tangible assets	Other provision and adjustments	Other temporary differences	Total
			Euro			
Opening balance . . .	285,609,807	6,650,220	10,548,118	2,598,294	6,129,203	311,535,642
Increases (reductions)						
Net income	(55,737,853)	1,502,099	(698,685)	81,582	2,170,865	(52,595,452)
Shareholders' equity	57,161,161	—	—	—	—	57,161,161
Closing balance . . .	<u>287,033,115</u>	<u>8,152,319</u>	<u>9,849,433</u>	<u>2,679,876</u>	<u>8,300,068</u>	<u>316,101,351</u>

Movements in deferred tax liabilities during the nine-month periods ended 30 September 2014 were as follows:

	30 Sep 2014		
	Assets revaluation	Capital gain with deferred taxation	Total
		Euro	
Opening balance	148,113,149	490,380	148,603,529
Increases (reductions)			
Net income	(7,076,078)	(37,422)	(7,113,500)
Closing balance	<u>141,037,071</u>	<u>452,958</u>	<u>141,490,029</u>

PT Comunicações
Notes to the Financial Statements (Continued)
As at 30 September 2014
(Amounts stated in Euros)

6.2. Tax rate reconciliation

In the nine-month periods ended 30 September 2014 and 2013, the reconciliation between the expected tax computed by applying the nominal tax rate to income before taxes and the total income tax is as follows:

	9M14	9M13
	Euro	
Income before taxes	(1,209,749,794)	(141,691,121)
Nominal tax rate	23.00%	25.00%
Expected tax	(278,242,453)	(35,422,780)
Permanent differences ^(a)	231,867,383	(34,287,299)
Tax loss used in connection with RETGS ^(b)	95,695,016	65,085,279
Surplus of prior year accrued income tax	682,732	742,270
Reversal of deferred taxes from previous years	(3,837,994)	1,089,109
Other	575,301	244,732
	46,739,985	(2,548,689)
Income tax		
Income tax-current	1,258,033	1,938,105
Deferred tax	45,481,952	(4,486,794)
	46,739,985	(2,548,689)

(a) Permanent differences are as follows:

	9M14	9M13
	Euro	
Equity method of accounting (Note14)	1,021,321,598	(128,598,002)
Recognition of capital gains and losses	(11,553,401)	(5,993,283)
Tax benefits	(3,082,921)	(3,153,658)
Other	1,433,779	595,748
	1,008,119,055	(137,149,195)
Nominal tax rate	23.00%	25.00%
	231,867,383	(34,287,299)

(b) This caption corresponds to the taxable loss computed in both years by the Company in accordance with Income Tax legislation. In accordance with the fiscal policy set by the Group, the gain related to the use of these tax losses has been recorded at the group level by the dominant entity of the tax consolidation group.

7. Accounts receivables and unbilled revenues

As at 30 September 2014 and 31 December 2013, these captions are made up as follows:

	30 Sep 2014			31 Dec 2013		
	Gross value	Impairment losses	Net value	Gross value	Impairment losses	Net value
	Euro					
Trade accounts receivable—current assets	575,671,437	(119,142,674)	456,528,763	589,980,787	(128,449,223)	461,531,564
Trade accounts receivable—non-current assets	366,358	—	366,358	76,189	—	76,189
Accounts receivable	576,037,795	(119,142,674)	456,895,121	590,056,976	(128,449,223)	461,607,753
Unbilled revenues	83,452,667	—	83,452,667	88,412,138	—	88,412,138
	659,490,462	(119,142,674)	540,347,788	678,469,114	(128,449,223)	550,019,891

PT Comunicações
Notes to the Financial Statements (Continued)
As at 30 September 2014
(Amounts stated in Euros)

7. Accounts receivables and unbilled revenues (Continued)

In the nine months period ended 30 September 2014, changes in accumulated impairment losses related to accounts receivable were as follows:

	Euro
Opening balance	128,449,223
Increases (reversals)	12,184,504
Utilizations ^(a)	(21,491,053)
Closing balance	119,142,674

(a) This line item refers to the use of accrued impairment losses to face of credits of doubtful collection that were deemed uncollectible and that were fully adjusted.

8. Provisions and contingent liabilities

8.1. Movements occurred in provisions

The movements in provisions during the nine months period ended 30 September 2014 were as follows:

	Tax claims	Other litigation	Provision for negative financial investments	Other provisions	Total
			Euro		
Opening balance	5,118,418	6,473,487	400,260	978,408	12,970,573
Increases	666,162	244,302	24,425	—	934,889
Reductions	(232,205)	(98,227)	(12,294)	—	(342,726)
Utilizations	(383,100)	—	—	(545,296)	(928,396)
Others ^(a)	13,125,100	—	300	—	13,125,400
Closing balance	18,294,375	6,619,562	412,691	433,112	25,759,740
Current	18,294,375	6,619,562	—	433,112	25,347,049
Non-current	—	—	412,691	—	412,691

(a) Includes an amount of Euro 13,125,100 relating to provisions that were previously recorded at Portugal Telecom and were transferred to the Company in connection with an internal restructuring of the PT Group for purposes of the Oi share capital increase (Note 1).

8.2. Tax contingencies and legal actions

a) Proceedings with probable losses

The provision for taxes is to cover several Corporate Income Tax and Social Security contingencies, as well as other taxes and fees.

The provision for legal processes in progress is to cover liabilities resulting from processes brought against the Company, estimated based on information from its lawyers.

As at 30 September 2014, the Company, based on the opinion of its internal and external lawyers, classified several legal and arbitration processes in progress and tax contingencies as of probable loss and so it recorded provisions in accordance with NCRF 21—Provisions, Contingent Liabilities and

PT Comunicações
Notes to the Financial Statements (Continued)
As at 30 September 2014
(Amounts stated in Euros)

8. Provisions and contingent liabilities (Continued)

Contingent Assets to cover the probable outflow of resources. As at 30 September 2014 and 31 December 2013, the nature of these proceeding is as follows:

	<u>30 Sep 2014</u>	<u>31 Dec 2013</u>
	Euro	
Legal proceedings		
Civil contingencies	1,328,590	1,372,668
Labor contingencies	2,374,625	2,130,323
Other contingencies	2,916,347	2,970,496
	<u>6,619,562</u>	<u>6,473,487</u>
Tax contingencies	18,294,375	5,118,418
	<u>24,913,937</u>	<u>11,591,905</u>

b) Proceedings with possible losses

As at 30 September 2014, the Company, in accordance with NCRF 21 and based on the opinion of internal and external legal counsel, had classified a variety of ongoing judicial and arbitral actions and tax contingencies as proceedings with possible losses. The nature of these proceedings is as follows:

	<u>30 Sep 2014</u>	<u>31 Dec 2013</u>
	Euro	
Legal proceedings		
Civil contingencies	70,092,713	70,241,929
Labor contingencies	298,009	542,461
Other contingencies	11,797,934	13,682,689
	<u>82,188,656</u>	<u>84,467,079</u>
Tax contingencies	34,077,308	22,475,467
	<u>116,265,964</u>	<u>106,942,546</u>

8.3. Description of the main claims with regulatory entities and other legal proceedings

The following litigation processes relate to the main claims and legal proceedings filed by regulatory entities against PT Comunicações, some of which the Company considers, based on the advice of its internal and external legal counsels that related losses are remote, in accordance with the definitions of NCRF 21.

a) Claims for municipal taxes and fees

Pursuant to a statute enacted on 1 August 1997, as an operator of a basic telecommunications network, Portugal Telecom was exempt from municipal taxes and rights-of-way and other fees with respect to its network in connection with its obligations under the Concession. The Portuguese Government has advised Portugal Telecom in the past that this statute confirmed the tax exemption under our Concession. The Portuguese Government has informed Portugal Telecom it will continue to take the necessary actions in order for PT Comunicações to maintain the economic benefits contemplated by the Concession.

Law 5/2004, dated 10 February 2004, established a new rights-of-way regime in Portugal whereby each municipality may establish a fee, up to a maximum of 0.25% of each wireline services bill, to be paid by the customers of those wireline operators whose network infrastructures are located in each such municipality. This regime was implemented in 2005 but does not affect the lawsuit described above based on the former statute. Meanwhile, Decree-Law 123/2009, dated 21 May 2009, clarified that no other tax should be levied by the municipalities in addition to the tax established by Law 5/2004. This interpretation was confirmed by the Supreme Administrative Court of Portugal in various legal actions.

PT Comunicações
Notes to the Financial Statements (Continued)
As at 30 September 2014
(Amounts stated in Euros)

8. Provisions and contingent liabilities (Continued)

Some municipalities however, continue to interpret that the Law 5/2004 does not expressly revoke other taxes that the municipalities wish to establish, because Law 5/2004 is not applicable to the public municipality domain. Currently, there are legal proceedings filed by some municipalities regarding this matter.

b) Regulatory proceedings

Portugal Telecom's operations are regularly subject to regulatory inquiries and investigations involving their operations. In addition, ANACOM (the telecommunications regulator), the European Commission, and the Autoridade da Concorrência (the competition authority) regularly make inquiries and conduct investigations concerning compliance with applicable laws and regulations. Current inquiries and investigations include several investigations by the (Autoridade da Concorrência) related to PT Comunicações for alleged anti-competitive practices in the Digital Terrestrial Television market. The Company believes that most of the complaints that have resulted in such investigations should be dismissed due to the nature of the alleged abuses and the novelty of the relevant antitrust laws. However, if PT Comunicações is found to be in violation of applicable laws and regulations in these or other regulatory inquiries and investigations, it could become subject to penalties, fines, damages or other sanctions. It is however permitted under Portuguese law to appeal any adverse decision to the Courts.

c) Other legal proceedings

In March 2004, TV TEL Grande Porto—Comunicações, SA. ("TVTEL"), a telecommunications company based in Oporto, filed a claim against PT Comunicações in the Lisbon Judicial Court. TV TEL alleged that, since 2001, PT Comunicações has unlawfully restricted access to its telecommunication ducts in Oporto, thereby undermining and delaying the installation and development of TV TEL's telecommunications network. TV TEL alleges that PT Comunicações intended to favor both itself and CATVP—TV Cabo Portugal, S.A, a PT Multimedia subsidiary and at the time a direct competitor of TV TEL. TV TEL is claiming an amount of approximately Euro 15 million from Portugal Telecom for damages and losses allegedly caused and yet to be sustained by that company as a result of the delay in the installation of its telecommunications network in Oporto. In addition, TV TEL has demanded that PT Comunicações be required to give full access to its ducts in Oporto. PT Comunicações submitted its defence to these claims, stating that: (1) TV TEL did not have a general right to install its network in PT Comunicações' ducts; (2) all of TV TEL's requests were lawfully and timely responded to by PT Comunicações according to its general infra-structure management policy; and (3) TV TEL's claims for damages and losses were not factually sustainable. On February 2013, the court decided a compensation related to increased costs of financing incurred and a value regarding loss of clients to be liquidated by TV TEL. Both parties have appealed and the Lisbon Judicial Court has ruled a decision in favour of PT Comunicações on 5 June 2014, decision that extended the scope of the trial, as a result of which a new trial date is expected.

In March 2011, Optimus—Comunicações S.A. ("Optimus") filed a claim against Portugal Telecom in the Judicial Court of Lisbon for the payment of approximately Euro 11 million related to a proceeding of the Autoridade da Concorrência that terminated in 2011 for prescription reasons, in relation to which Autoridade da Concorrência had imposed a fine to Portugal Telecom of approximately Euro 45 million. Optimus sustained his position by arguing that suffered losses and damages as a result of the Company's conduct. Currently, a collegial expertise is underway.

8.4. Tax contingencies

In addition to the tax contingencies mentioned above, the risk of loss of which was deemed as either probable or possible (Note 8.2), there are other tax claims pending appeal or judicial decision, totalling Euro 22 million, which include primarily (1) tax assessments filed by the tax authorities with respect to the

PT Comunicações
Notes to the Financial Statements (Continued)
As at 30 September 2014
(Amounts stated in Euros)

8. Provisions and contingent liabilities (Continued)

income tax from 1997 to 1998 of Portugal Telecom, SA and Marconi, and for 2002 and 2010 of PT Comunicações, and (2) additional payments of VAT from 2000 to 2004. The Company's opinion, based on the advice of its tax and legal counsel, is that the risk of loss associated with these claims is remote.

9. Loans obtained

Loans obtained as at 30 September 2014 and 31 December 2013 are as follows:

	30 Sep 2014		31 Dec 2013	
	Non-current	Current	Non-current	Current
	Euro			
Intragroup loans	6,337,350,000	—	3,779,000,000	—
Centralized cash management	—	—	—	342,322,714
Commercial programme	953,400,000	—	3,086,750,000	—
Leases	11,327,483	15,898,343	11,656,946	20,576,337
	<u>7,302,077,483</u>	<u>15,898,343</u>	<u>6,877,406,946</u>	<u>362,899,051</u>

9.1. Loans to Group companies

During the nine-month periods ended 30 September 2013 and 2014, the Company obtained additional loans from PT Portugal amounting to Euro 252,000,000 and Euro 2,558,350,000 (Note 3), respectively, as a result of which the outstanding amount was increased to Euro 3,779,000,000 and to Euro 6,337,350,000. These loans have no defined maturity, but shall be repaid, partially or entirely, in more than one year, subject to the cash needs of the Company. The interest on these loans is linked to market rates.

9.2. Centralized cash management

As from March 2006, Portugal Telecom centralized all cash receipts and payments from Group companies located in Portugal. In 2014, PT Portugal replaced Portugal Telecom as the parent company of the Group in Portugal and accordingly also replaced Portugal Telecom in its role under this centralized cash management system. The financings obtained by the Company under this system have short term maturities and bear interest at market rates.

9.3. Commercial paper

During the nine months period ended 30 September 2014, the Company reduced the outstanding amounts due under commercial paper programmes by Euro 2,133,350,000, as a result of which the total amount outstanding as at 30 September 2014 was decreased to Euro 953,400,000. These commercial paper programmes have basically the same features as described in the 2013 annual report.

10. Post-retirement benefits

As at 30 September 2014, the Company did not obtain an actuarial valuation to recognize post retirement benefits and, therefore, costs recorded during the nine months period ended 30 September 2014 are based on the 31 December 2013 actuarial valuation, adjusted by curtailment costs incurred during that period.

As at 30 September 2014, the projected post retirement benefits obligations, which relate to pension complements and healthcare benefits, totalled Euro 515 million and the fair value of plan assets amounted to Euro 253 million, as compared to Euro 492 million and Euro 386 million as at 31 December 2013, respectively. In addition, PT Comunicações had liabilities with salaries payable to suspended and pre-retired employees amounting to Euro 802 million as at 30 September 2014, as compared to

PT Comunicações
Notes to the Financial Statements (Continued)
As at 30 September 2014
(Amounts stated in Euros)

10. Post-retirement benefits (Continued)

Euro 836 million as at 31 December 2013, which are not subject to any legal funding requirement. These salaries are paid on a monthly basis directly by PT Comunicações to beneficiaries until retirement age. Consequently, as at 30 September 2014, net benefits obligations amounted to Euro 1,064 million, as compared to Euro 942 million as at 31 December 2013.

The fair value of plan assets as at 30 September 2014, amounting to Euro 253 million, include funds incorporated to cover pensions supplements and healthcare benefits obligations, amounting to Euro 94 million and Euro 158 million, respectively. The healthcare fund, which was incorporated in 2004, is managed independently by PT Prestações in accordance with an investment policy and includes shares, bonds and other investments. As at 30 September 2014, the total exposure of these investments to private equity funds managed by Global Investment Opportunities SICAV of Rocha dos Santos Holding amounted to Euro 80 million.

During the nine months period ended 30 September 2014, the changes in post retirement benefits obligations, net of the fair value of plan assets, were as follows:

	Pension complements benefits	Healthcare benefits	Salaries due to Pre-retired and suspended employees	Total
	Euro			
Balance as at 31 December 2013 . . .	21,697,157	83,990,552	836,277,930	941,965,639
Periodic post retirement benefits costs	705,750	4,494,750	11,288,250	16,488,750
Work force reduction costs	710,080	710,080	28,403,205	29,823,365
Curtailment gain due to change in benefits	—	(51,873,000)	—	(51,873,000)
Net actuarial losses (gains)	(2,580,963)	209,807,751	41,300,000	248,526,788
Payments, contributions and reimbursements	(2,022,807)	(3,635,558)	(115,528,598)	(121,186,963)
Balance as at 30 September 2014 . .	<u>18,509,217</u>	<u>243,494,575</u>	<u>801,740,787</u>	<u>1,063,744,579</u>

Certain post retirement benefits plans for which the fair value of plan assets exceed the projected post-retirement benefit obligation, and an asset can be recorded as it is possible for the Company to use the surplus, are presented in the Balance Sheet separately from those plans with a projected post-retirement benefits obligations exceeding the fair value of their plan assets. As at 30 September 2014 and 31 December 2013, net post retirement obligations were recognized in the Balance Sheet as follows:

	30 Sep 2014	31 Dec 2013
	Euro	
Pension plans with a deficit position	20,444,269	23,531,157
Salaries to pre-retired and suspended employees	801,740,787	836,277,930
Healthcare plans with a deficit position	243,494,575	83,990,552
Plans with a deficit position	<u>1,065,679,631</u>	<u>943,799,639</u>
Pension plans with a surplus position	(1,935,052)	(1,834,000)
	<u>1,063,744,579</u>	<u>941,965,639</u>

PT Comunicações
Notes to the Financial Statements (Continued)
As at 30 September 2014
(Amounts stated in Euros)

10. Post-retirement benefits (Continued)

The detail of post retirement benefits costs in the nine-month periods ended 30 September 2014 and 2013 is as follows:

	9M14	9M13
	Euro	
Post retirement benefits costs		
Periodic service cost	2,842,500	3,095,129
Net interest cost	13,646,250	12,383,791
	16,488,750	15,478,920
Service cost related to liabilities transferred to the Portuguese State ⁽ⁱ⁾	14,720,805	16,184,481
Total post retirement benefits costs	31,209,555	31,663,401
Work force reduction costs		
Work force reduction costs	29,823,365	102,002,172
Curtailment gain due to change in benefits ⁽ⁱⁱ⁾	(51,873,000)	—
Termination payments	172,133	287,919
Total work force reduction costs	(21,877,502)	102,290,091

(i) This caption relates to a contribution to the Portuguese Social Security System, regarding the annual service of active employees that were entitled to pension benefits under the Company's post retirement benefits plans transferred to the Portuguese State in December 2010.

(ii) This caption corresponds to the estimated net gain resulting from the reduction in benefits granted under the healthcare plan, as a result of which the related projected benefit obligations were decreased by this amount.

Net actuarial losses, which are recorded directly in shareholders' equity, have the following composition in the nine-month periods ended 30 September 2014 and 2013:

	9M14	9M13
	Euro	
Differences between actual data and actuarial assumptions ⁽ⁱ⁾	128,126,788	13,539,460
Changes in actuarial assumptions ⁽ⁱⁱ⁾	120,400,000	—
	248,526,788	13,539,460

(i) This caption corresponds to the net actuarial losses recorded in both periods reflecting the difference between actual return on plan assets and the expected return on plan assets computed based on the discount rates for the related obligations. Net actuarial losses recorded in the nine months period ended 30 September 2014 reflect basically the impairment of the investment in Banco Espírito Santo ("BES") shares, as a result of the BES corporate reorganization announced on 3 August 2014, under which the former shareholders of BES became holders of an entity with assets not related to the banking business and not listed in the stock market.

(ii) This caption corresponds to the estimated impact resulting from the decrease in discount rates use to compute the presented value of projected benefit obligations. Given the evolution of long-term yield rates of Euro Zone high-rating corporate bonds, the Company decided to reduce the discount rates for all responsibilities, namely (1) from 3.00% to 2.00% for pension supplements, (2) from 4.00% to 2.50% for healthcare benefits, and (3) from 2.00% to 0.75% for salaries payable to pre-retired and suspended employees.

PT Comunicações
Notes to the Financial Statements (Continued)
As at 30 September 2014
(Amounts stated in Euros)

10. Post-retirement benefits (Continued)

Net cash out flows relating to post retirement benefits in the nine-month periods ended 30 September 2014 and 2013 are as follows:

	9M14	9M13
	Euro	
Payments of salaries to pre-retired and suspended employees	115,528,598	114,939,611
Contributions to the pension funds	1,120,000	478,805
Reimbursements related to healthcare expenses	3,635,558	1,801,360
Payments of pension complements benefits	902,807	621,239
	121,186,963	117,841,015
Service cost related to liabilities transferred to the Portuguese State ⁽ⁱ⁾ .	14,806,631	16,048,946
Termination payments	172,133	287,919
	136,165,727	134,177,880

(i) This caption corresponds to the contribution paid by Portugal Telecom to the Portuguese Social Security System, relating to the annual service of active employees that were entitled to pension benefits under the Company's post retirement benefits plans transferred to the Portuguese State in December 2010.

11. Suppliers and Investment suppliers

As at 30 September 2014 and 31 December 2013, the captions "Suppliers" and "Investment suppliers" have the following composition:

	30 Sep 2014	31 Dec 2013
	Euro	
Trade suppliers		
Current	434,917,433	319,470,088
Invoices to be received	20,926,614	25,651,226
	455,844,047	345,121,314
Investment suppliers		
Current	24,278,354	74,443,261
Invoices to be received	8,808,876	25,684,107
	33,087,230	100,127,368

12. Accrued expenses

As at 30 September 2014 and 31 December 2013, this caption is made up as follows:

	30 Sep 2014	31 Dec 2013
	Euro	
Direct costs of services rendered	89,598,983	84,806,581
Interest and other financial expenses payable	86,848,626	107,973,460
Charges for vacations, vacation subsidies and other payroll costs . . .	51,729,701	42,964,245
Other supplies and external services	17,504,882	16,132,996
Support services	8,502,920	8,186,121
Credits related to invoices issued	8,291,931	10,153,020
Rentals	5,024,670	4,495,887
Maintenance and repairs	4,449,050	3,957,839
Specialized work	2,268,143	3,176,246
Marketing and publicity	1,808,872	2,192,106
Other	7,361,209	9,266,319
	283,388,987	293,304,820

PT Comunicações
Notes to the Financial Statements (Continued)
As at 30 September 2014
(Amounts stated in Euros)

13. Services rendered and sales

In the nine-month periods ended 30 September 2014 and 2013, these captions are made up as follows:

	<u>9M14</u>	<u>9M13</u>
	Euro	
Services rendered		
Television services	445,671,040	419,319,848
Fixed telephone services	386,707,289	409,009,559
Leased lines and capacity	113,442,058	125,271,558
Internet	111,354,021	117,269,762
System solutions and information technology and outsourcing	69,878,540	69,143,422
Data communications (services)	54,030,683	58,760,738
Directories	15,195,098	19,401,588
Publicity	9,598,110	8,427,056
Other	45,740,236	39,048,596
Sales	17,977,131	13,283,358

14. Equity in earnings (losses) of affiliated companies

In the nine-month periods ended 30 September 2014 and 2013, this caption consists of the following:

	<u>9M14</u>	<u>9M13</u>
	Euro	
Gains and losses in affiliated companies		
Gains	1,179,331	230,603,403
Losses	(1,022,500,929)	(102,005,401)
Gains and losses on the disposal of affiliated companies		
Gains ^(a)	—	32,729,942
Losses	—	(521)
	<u>(1,021,321,598)</u>	<u>161,327,423</u>

(a) In 2013, this caption corresponds to the gain recorded with the disposal of the investment in CTM.

PT Comunicações
Notes to the Financial Statements (Continued)
As at 30 September 2014
(Amounts stated in Euros)

14. Equity in earnings (losses) of affiliated companies (Continued)

In the nine-month periods ended 30 September 2014 and 2013, gains and losses in affiliated companies, resulting from the application of the equity method of accounting (Note 5), were recognized in the following captions:

	9M14	9M13
	Euro	
Financial investments (Note 5)		
Meo, SA	(1,021,658,153)	128,702,013
Sportinveste Multimédia	(353,060)	—
Infonet	(237,774)	(147,622)
Multicert	(223,178)	24,664
PT Brasil	—	100
Janela Digital	1,137,341	—
PT Blue Clip	19,435	10,339
Capital Criativo	13,459	18,096
Auto Sapo	4,679	(3,526)
PT Cloud e Data Centers, S.A.	78	—
	(1,021,297,173)	128,604,064
Provision for negative financial investments (Note 8)		
Yunit Serviços	(28,764)	—
PT Cloud e Data Centers, S.A.	3,079	(6,294)
PT Prestações	1,260	232
	(24,425)	(6,062)
	(1,021,321,598)	128,598,002

The Company's share in net losses of MEO, SA, amounting to Euro 1,021,658,153, reflects primarily MEO, S.A.'s share in net losses of its subsidiary PT Móveis, amounting to Euro 1,034,664,295, which in turn reflects mainly a net loss of Euro 950 million recorded by PT Móveis in connection with the disposal of its 100% interest in Bratel BV to Portugal Telecom, which includes (1) a capital gain of Euro 50 million reflecting the difference between the sale price (Euro 4,195 million) and the carrying value of the total investment in Bratel BV (Euro 4,145 million, already reflecting the share capital increase realized by PT Móveis in Bratel BV prior to the sale, amounting to Euro 1,303 million), and (2) the cumulative amount of negative currency translation adjustments, amounting to Euro 1,000 million, which were generated since the acquisition of the investment in Oi in March 2011 and transferred to net income upon the sale of this investment through Bratel BV on 2 May 2014.

15. Direct costs

In the nine-month periods ended 30 September 2014 and 2013, this caption consists of the following:

	9M14	9M13
	Euro	
Telecommunications costs	245,094,911	237,894,739
Programming costs	94,420,974	94,810,563
Directories	13,280,192	15,956,472
Contents of internet and mobile service	6,958,639	6,868,513
Other	12,431,545	12,584,342
	372,186,261	368,114,629

PT Comunicações
Notes to the Financial Statements (Continued)
As at 30 September 2014
(Amounts stated in Euros)

16. Supplies and external services

In the nine-month periods ended 30 September 2014 and 2013, this caption consists of the following:

	<u>9M14</u>	<u>9M13</u>
	Euro	
Support services	146,271,549	127,110,742
Maintenance and repairs	46,468,984	53,796,724
Commissions	44,527,874	44,523,927
Electricity	22,270,644	24,692,436
Rentals	16,445,224	15,811,325
Communications	10,251,244	10,574,846
Specialized work	10,058,911	12,589,487
Fuel, water and other fluids	4,434,407	5,283,040
Other	18,123,413	19,787,283
	<u>318,852,250</u>	<u>314,169,810</u>

17. Wages and salaries

In the nine-month periods ended 30 September 2014 and 2013, this caption consists of the following:

	<u>9M14</u>	<u>9M13</u>
	Euro	
Salaries	151,643,687	150,368,659
Social Security charges	18,546,694	17,618,394
Social events	2,120,828	2,584,430
Training	1,485,682	752,579
Healthcare	1,460,225	1,624,486
Other	895,179	1,337,400
	<u>176,152,295</u>	<u>174,285,948</u>

18. Interest and related income/expense

In the nine-month periods ended 30 September 2014 and 2013, this caption consists of the following:

	<u>9M14</u>	<u>9M13</u>
	Euro	
Interest and related income		
Interest income	768,180	3,063,174
Gains on exchange rate differences	1,892,399	1,552,170
Other	8,148	119,931
	<u>2,668,727</u>	<u>4,735,275</u>
Interest and related expenses		
Interest expense	276,094,431	267,589,385
Bank commissions and expenses	7,202,913	4,170,487
Losses on exchange rate differences	1,181,369	2,539,385
Finance leases	663,961	973,042
Other	197,910	370,700
	<u>285,340,584</u>	<u>275,642,999</u>

PT Comunicações
Notes to the Financial Statements (Continued)
As at 30 September 2014
(Amounts stated in Euros)

18. Interest and related income/expense (Continued)

The breakdown of interest income and interest expense in the nine-month periods ended 30 September 2014 and 2013 is as follows:

	<u>9M14</u>	<u>9M13</u>
	Euro	
Interest income		
Intragroup loans ^(a)	637,669	2,890,693
Other	130,511	172,481
	<u>768,180</u>	<u>3,063,174</u>
Interest expense		
Intragroup loans ^(b)	214,242,817	145,983,523
Bank loans ^(b)	61,269,445	121,454,383
Other	582,169	151,479
	<u>276,094,431</u>	<u>267,589,385</u>

(a) The decrease in interest income reflects primarily the repayment of the intercompany loans granted to Meo, S.A..

(b) The increase in interest expenses from intragroup loans reflects an increase in intercompany loans due to PT Portugal and the reduction in interest expense from bank loans reflects the decrease in outstanding amounts regarding commercial paper issued by the Company.

19. Earnings per share

Earnings per share for the nine-month periods ended 30 September 2014 and 2013 were computed as follows:

	<u>9M14</u>	<u>9M13</u>
Net income	(1,256,489,779)	(139,142,432)
Number of shares	1,150,000,000	1,150,000,000
Basic earnings per share	<u>(1.09)</u>	<u>(0.12)</u>

There are no situations that create a dilutive effect, so the diluted earnings per share are the same as basic earnings per share.

PT Comunicações
Notes to the Financial Statements (Continued)
As at 30 September 2014
(Amounts stated in Euros)

20. Guarantees

As at 30 September 2014 and 31 December 2013, the Company had presented the following guarantees in favour of third parties:

	<u>30 Sep 2014</u>	<u>31 Dec 2013</u>
	Euro	
Guarantees in favour of courts	1,519,886	1,608,722
Bank guarantees in favor of other entities:		
Highway construction entities	5,030,089	5,734,356
Ministry of Education	3,795,748	3,161,016
Ministry of Justice	3,550,393	7,789,951
Municipalities	2,185,842	2,496,807
CTT	3,009,150	2,007,831
Ministry of Health	1,155,000	1,038,512
Other	5,876,440	6,714,826
	24,602,662	28,943,299
Total guarantees	26,122,548	30,552,021
Commitments of purchase before:		
Fixed asset and content suppliers	20,001,786	19,956,279
Suppliers of inventories	18,417,258	20,398,178
Other services	41,936,315	46,780,174
	80,355,359	87,134,631

Bank guarantees presented to the tax authorities relate primarily to additional income tax assessments for which the Company submitted a claim or an appeal.

As of 30 September 2014, Portugal Telecom, SGPS, S.A. had presented bank guarantees in favor of the tax authorities in relation to additional tax assessments received by Portugal Telecom regarding the tax consolidation of the years 2005 to 2010, thus including the tax contingencies of PT Comunicações, S.A. as well as tax contingencies of other entities included in the tax consolidation group, namely Meo, S.A. and Portugal Telecom. These bank guarantees totaled Euro 353 million as of 30 September 2014. In accordance with Portuguese tax legislation, Portugal Telecom has presented these guarantees and submitted a claim or an appeal to the tax authorities in order to be able to hold open discussions with the tax authorities and avoid the payment of a given tax assessment. In Portugal, these two conditions are required and must be complied with before the process can continue, regardless of the amount of the tax assessment or the likelihood of success of the appeal or the claim.

21. Events occurred after the balance sheet date

The financial statements as of and for the nine months period ended 30 September 2014 were approved by the Board of Directors and authorised for issuance on 13 January 2015.

On 1 December 2014, Oi entered into an exclusivity agreement with Altice, S.A. to allow both entities to negotiated and agree on the final terms of the sale of PT Portugal. On 8 December 2014, the Board of Directors of Oi finalized the formalities to approve the general terms and conditions for the sale of all shares of PT Portugal to Altice Portugal, S.A., a wholly-owned subsidiary of Altice, S.A.. The sale substantially involves PT Portugal's operations in Portugal and Hungary. The effectiveness of the purchase and sale contract will depend on the approvals by the shareholders of Portugal Telecom SGPS, S.A., scheduled for 12 January 2015, and by the proper regulatory entities. With this approval, Oi will transfer to Altice all of the shares issued by PT Portugal for an enterprise value of Euro 7.4 billion, adjusting for cash and debt and including an earn-out of Euro 500 million related to PT Portugal's

PT Comunicações
Notes to the Financial Statements (Continued)
As at 30 September 2014
(Amounts stated in Euros)

21. Events occurred after the balance sheet date (Continued)

generation of future revenue. The price to be paid by Altice will suffer adjustments usually adopted in similar transactions, in accordance with PT Portugal's cash holdings on the closing of this transaction.

On 29 December 2014, Meo, S.A. was merged into PT Comunicações and accordingly ceased to exist, but its assets and liabilities were entirely transferred to the Company and thus Meo, S.A.'s activity will continue in the future. This merger produced effects as from 1 January 2014. Following this merger, PT Comunicações was renamed *MEO—Serviços de Comunicações e Multimédia, S.A.*

Financial Statements

STATUTORY AUDITORS' REPORT

(Translation of a report originally issued in Portuguese—Note 39)

Introduction

1. We have audited the accompanying financial statements of PT Comunicações, S.A. (“the Company”), which comprise the balance sheet as of 31 December 2013 that presents a total of 13,888,129,071 Euros and shareholders’ equity of 4,653,549,363 Euros, including a net loss of 210,225,304 Euros, the statements of income by nature, of changes in shareholders’ equity and of cash flows for the year then ended and the corresponding notes.

Responsibilities

2. The preparation of financial statements that present a true and fair view of the financial position of the Company, the results of its operations, the changes in its shareholders’ equity and its cash flows, as well as the adoption of adequate accounting principles and criteria and the maintenance of an appropriate system of internal control are the responsibility of the Company’s Board of Directors. Our responsibility is to express a professional and independent opinion on these financial statements, based on our audit.

Scope

3. Our audit was performed in accordance with the auditing standards (“*Normas Técnicas e as Diretrizes de Revisão/Auditoria*”) issued by the Portuguese Institute of Statutory Auditors (“*Ordem dos Revisores Oficiais de Contas*”), which require that the audit be planned and performed with the objective of obtaining reasonable assurance about whether the financial statements are free of material misstatement. An audit includes verifying, on a sample basis, evidence supporting the amounts and disclosures in the financial statements and assessing the significant estimates, based on judgements and criteria defined by the Board of Directors, used in their preparation. An audit also includes assessing the adequacy of the accounting principles used and their disclosure, taking into consideration the circumstances, verifying the applicability of the going concern concept and assessing the adequacy of the overall presentation of the financial statements. Our audit also included verifying that the financial information contained in the Managements’ Report is in accordance with the financial statements. We believe that our audit provides a reasonable basis for expressing our opinion.

Opinion

4. In our opinion, the financial statements referred to in paragraph 1 above, present fairly, for the purpose explained in paragraph 5 below, in all material respects, the financial position of PT Comunicações, S.A. as of 31 December 2013 and the results of its operations, the changes in its shareholders’ equity and its cash flows for the year then ended, in conformity with generally accepted accounting principles in Portugal.

Emphasis

5. The financial statements mentioned in paragraph 1 above refer to the Company on a standalone basis and were prepared in accordance with current legislation for approval and publication. The Company will not prepare consolidated financial statements as, in accordance with number 3 of article 7 of Decree-Law 158/2009, of 13 July 2009 is not required to do so, as its financial statements will be included in the consolidated financial statements of Portugal Telecom, SGPS, S.A.. As described in Note 3.7, although the financial investments have been accounted for by the equity method, under which the Company’s net profit for the year and shareholders’ equity include the effect of consolidating the subsidiary and associated companies, the accompanying financial statements do not include the effects of a full consolidation of their assets, liabilities, revenues and costs.

Report on other legal requirements

6. It is also our opinion that the financial information contained in the Managements' Report is consistent with the financial statements for the year.

Lisbon, 11 February 2014

Deloitte & Associados, SROC S.A.
Represented by João Luís Falua Costa da Silva

PT COMUNICAÇÕES, S.A.
BALANCE SHEETS
31 DECEMBER 2013 AND 2012

	Notes	2013	2012 restated Euro
ASSETS			
Non-current assets			
Tangible fixed assets	6	2,687,744,235	2,813,701,186
Investment properties	7	12,987,051	8,863,837
Goodwill	8	2,982,442,403	2,982,442,403
Intangible assets	9	212,789,378	235,272,678
Financial investments—equity method of accounting	10	6,920,678,140	7,257,167,784
Financial investments—other methods		1,224,907	1,125,252
Post retirement benefits	11	1,834,000	1,632,840
Shareholders and group companies	12	—	340,000,000
Other financial assets	14	4,077,850	373,631
Deferred tax assets	15	311,535,642	310,743,798
Total non-current assets		13,135,313,606	13,951,323,409
Current assets			
Inventories	16	30,711,476	48,909,973
Accounts receivable—trade	17	461,531,564	470,155,099
Unbilled revenues	17	88,412,138	64,005,319
Advances to suppliers		6,292,151	8,093,866
State and other public entities	18	—	193,752
Other accounts receivable	19	123,456,398	117,888,755
Deferrals	13	16,020,983	17,991,662
Non-current assets held for sale	20	4,653,742	5,069,882
Cash and bank deposits	4	21,737,013	21,165,981
Total current assets		752,815,465	753,474,289
Total assets		13,888,129,071	14,704,797,698
SHAREHOLDERS' EQUITY			
Share capital	21	1,150,000,000	1,150,000,000
Other shareholders' equity instruments	21	4,350,466,191	4,350,466,191
Legal reserve	21	30,000,000	30,000,000
Other reserves	21	178,133,162	295,771,223
Adjustments to financial assets	21	(745,613,034)	(456,822,242)
Revaluation surplus	21	567,494,032	589,044,034
Other shareholders' equity variations	21	3,373,856	5,524,632
Retained earnings		(670,079,540)	(361,640,978)
Net (loss) / income		(210,225,304)	(91,330,314)
Total shareholders' equity		4,653,549,363	5,511,012,546
LIABILITIES			
Non-current liabilities			
Provisions	22	400,260	297,348
Loans obtained	23	6,877,406,946	6,178,861,415
Deferrals	13	—	665,145
Post retirement benefits	11	943,799,639	830,722,899
Deferred tax liabilities	15	148,603,529	173,706,683
Other financial liabilities		143,238	135,417
Total non-current liabilities		7,970,353,612	7,184,388,907
Current liabilities			
Provisions	22	12,570,313	24,644,235
Loans obtained	23	362,899,051	1,184,254,516
Deferrals	13	92,590,506	74,318,913
Accounts payable to group companies	12	3,202,808	1,657,243
Suppliers	24	345,121,314	287,941,611
Investment suppliers	24	100,127,368	108,132,521
Accrued expenses	25	293,304,820	268,018,929
Advances from accounts receivable		6,645,294	6,627,708
State and other public entities	18	18,982,227	38,844,553
Other accounts payable	19	28,782,395	14,956,016
Total current liabilities		1,264,226,096	2,009,396,245
Total liabilities		9,234,579,708	9,193,785,152
Total liabilities and shareholders' equity		13,888,129,071	14,704,797,698

The accompanying notes form an integral part of these financial statements.

Accountant

The Board of Directors

PT COMUNICAÇÕES, S.A.
INCOME STATEMENTS
FOR THE YEARS ENDED 31 DECEMBER 2013 AND 2012

	Notes	2013	2012 restated Euro
Services rendered	26	1,686,252,480	1,749,171,088
Sales	26	21,975,806	25,146,653
Subsidies to operation		118,618	104,184
Production variation	16	1,063,095	(1,512,527)
Equity in earnings of affiliated companies, net	27	234,395,437	120,530,483
Own work capitalized	6	49,637,291	42,064,039
Costs of products sold	16	(24,946,315)	(31,638,682)
Direct costs	28	(492,172,901)	(484,044,683)
Marketing and publicity		(26,221,698)	(20,749,856)
Supplies and external services	29	(431,047,234)	(445,404,596)
Wages and salaries	30	(231,889,909)	(235,490,588)
Post retirement benefit costs	11	(40,254,067)	(57,329,020)
Curtailement and settlement costs	11	(112,800,916)	(1,160,449)
Indirect taxes	31	(14,185,584)	(15,398,573)
Impairment of inventories ((losses)/reversals)	16	752,821	3,566,877
Impairment of accounts receivable ((losses)/reversals)	17,19	(22,977,273)	(25,274,422)
Provisions (increases/reductions)	22	6,129,210	(8,181,810)
Other income and gains	32	99,401,707	123,837,854
Other expenses and losses	33	(56,522,263)	(28,516,504)
INCOME BEFORE DEPRECIATION AND AMORTISATION, FINANCING EXPENSES AND TAXES		646,708,305	709,719,468
Depreciation and amortisation ((losses)/reversals)	34	(480,928,166)	(497,654,649)
OPERATING INCOME (BEFORE FINANCING EXPENSES AND TAXES)		165,780,139	212,064,819
Interest and related income	35	6,917,719	15,267,912
Interest and related expenses	35	(373,045,707)	(321,007,507)
INCOME BEFORE TAXES		(200,347,849)	(93,674,776)
Income taxes	15	(9,877,455)	2,344,462
NET (LOSS) / INCOME		(210,225,304)	(91,330,314)
Basic earnings per share	36	(0.18)	(0.08)

The accompanying notes form an integral part of these financial statements.

Accountant

The Board of Directors

PT COMUNICAÇÕES, S.A.
STATEMENTS OF CHANGES IN SHAREHOLDERS' EQUITY
FOR THE YEARS ENDED 31 DECEMBER 2012 AND 2013

		Share capital (Note 21.1)	Other shareholders' equity instruments (Note 21.2)	Legal reserve (Note 21.3)	Other reserves (Note 21.4)	Adjustments to financial assets (Note 21.5)	Revalu- surpl (Note 2
Euro							
Balance as at 1 January 2012 (restated)	A	1,150,000,000	4,350,466,191	30,000,000	329,974,035	(206,382,607)	623,874
Changes:							
Foreign currency translation adjustments		—	—	—	—	(350,270,498)	—
Actuarial losses recognised in the year (Note 11.7)		—	—	—	(45,603,748)	—	—
Unpaid dividends		—	—	—	—	50,868,659	—
Deferred taxes adjustments (Nota 15.2)		—	—	—	11,400,936	30,434	—
Realization of revaluation surplus		—	—	—	—	—	(34,830)
Recognition of investments subsidiaries		—	—	—	—	—	—
Other changes in shareholders' equity		—	—	—	—	48,931,770	—
	B	—	—	—	(34,202,812)	(250,439,635)	(34,830)
Net loss	C	—	—	—	—	—	—
Comprehensive income	B+C	—	—	—	—	—	—
Operations with shareholders:							
Application of earnings	D	—	—	—	—	—	—
Balance as at 31 December 2012 (restated)	E=A+B+C+D	1,150,000,000	4,350,466,191	30,000,000	295,771,223	(456,822,242)	589,044
Changes:							
Foreign currency translation adjustments		—	—	—	—	(533,678,908)	—
Actuarial losses recognised in the year (Note 11.7)		—	—	—	(138,786,000)	—	—
Unpaid dividends		—	—	—	—	250,643,469	—
Deferred taxes adjustments (Nota 15.2)		—	—	—	21,147,939	182,856	12,879
Realization of revaluation surplus		—	—	—	—	—	(34,425)
Effect of disposals of subsidiaries		—	—	—	—	—	—
Recognition of investments subsidiaries		—	—	—	—	—	—
Other changes in shareholders' equity		—	—	—	—	(5,938,209)	—
	F	—	—	—	(117,638,061)	(288,790,792)	(21,550)
Net loss	G	—	—	—	—	—	—
Comprehensive income	F+G	—	—	—	—	—	—
Operations with shareholders:							
Application of earnings	H	—	—	—	—	—	—
Balance as at 31 December 2013	I = E+F+G+H	1,150,000,000	4,350,466,191	30,000,000	178,133,162	(745,613,034)	567,494

The accompanying notes form an integral part of these financial statements.

Accountant

PT COMUNICAÇÕES, S.A.
STATEMENTS OF CASH FLOWS
FOR THE YEARS ENDED 31 DECEMBER 2013 AND 2012

	Notes	2013	2012
Euro			
OPERATING ACTIVITIES			
Collections from clients		2,234,164,263	2,404,763,511
Payments to suppliers		(1,265,720,471)	(1,409,895,617)
Payments to employees		(193,067,691)	(206,406,932)
Cash flows from operations		775,376,101	788,460,962
Cash receipts (payments) relating to income taxes	4.(a)	(6,289,893)	35,940,339
Payments relating to post retirement benefits	11.5	(178,934,112)	(186,386,464)
Other cash payments, net		(101,352,190)	(94,253,860)
Cash flows from operating activities (1)		488,799,906	543,760,977
INVESTING ACTIVITIES			
Cash receipts resulting from:			
Tangible fixed assets		6,075,430	3,658,939
Intangible assets		9,379	—
Financial investments	4.(b)	36,475,260	—
Loans granted	4.(c)	340,000,000	—
Interest and related income		33,258,253	2,897,304
Dividends	4.(d)	2,703,029	238,273,153
		418,521,351	244,829,396
Payments resulting from:			
Tangible fixed assets		(399,094,673)	(531,243,187)
Intangible assets		(8,766,661)	(7,758,325)
Financial investments	4.(e)	(35,022,008)	(2,160,372)
Loans granted		(9,015,000)	(600,000)
		(451,898,342)	(541,761,884)
Cash flows from investing activities (2)		(33,376,991)	(296,932,488)
FINANCING ACTIVITIES			
Cash receipts resulting from:			
Loans obtained	4.(f)	476,357,190	1,092,000,000
Subsidies		339,730	1,251,413
		476,696,920	1,093,251,413
Payments resulting from:			
Loans repaid	4.(f)	(608,647,727)	(947,867,596)
Interest and related expenses		(321,044,395)	(426,211,970)
		(929,692,122)	(1,374,079,566)
Cash flows from financing activities (3)		(452,995,202)	(280,828,153)
Change in cash and cash equivalents			
(4) = (1) + (2) + (3)		2,427,713	(33,999,664)
Effect of exchange differences		(1,856,681)	(25,742)
Cash and cash equivalents at the beginning of the period		21,165,981	55,191,387
Cash and cash equivalents at the end of the period	4.(g)	21,737,013	21,165,981

The accompanying notes form an integral part of these financial statements.

Accountant

The Board of Directors

INDEX

1.	Introduction	F-316
2.	Basis of presentation	F-318
3.	Main accounting policies, judgments and estimates	F-319
4.	Cash flows	F-330
5.	Changes in accounting policies and estimates and errors	F-333
6.	Tangible fixed assets	F-334
7.	Investment properties	F-337
8.	Goodwill	F-337
9.	Intangible assets	F-338
10.	Financial investments-equity method of accounting	F-340
11.	Post-retirement benefits	F-342
12.	Related parties	F-353
13.	Deferrals	F-361
14.	Other financial assets	F-361
15.	Income taxes	F-362
16.	Inventories	F-365
17.	Accounts receivable and unbilled revenues	F-366
18.	State and other public entities	F-367
19.	Other accounts receivable and payable	F-368
20.	Non-current assets held for sale	F-369
21.	Shareholders' equity	F-370
22.	Provisions, contingent liabilities and contingent assets	F-373
23.	Loans obtained	F-377
24.	Suppliers	F-379
25.	Accrued expenses	F-380
26.	Services rendered and sales	F-380
27.	Equity in earnings of affiliated companies	F-381
28.	Direct costs	F-382
29.	Supplies and external services	F-382
30.	Wages and salaries	F-383
31.	Indirect taxes	F-383
32.	Other income and gains	F-383
33.	Other expenses and losses	F-384
34.	Depreciation and amortization ((losses)/reversals)	F-384
35.	Interest and related income/expenses	F-384
36.	Earnings per share	F-385
37.	Guarantees and other financial commitments	F-386
38.	Events occurred after the balance sheet date	F-386
39.	Note added for translation	F-386

PT Comunicações
Notes to Financial Statements
As at 31 December 2013
(Amounts in Euro)

1. Introduction

(a) Development of the company

PT Comunicações, S.A. (“PT Comunicações” or the “Company”) was incorporated in 2000, in accordance with a resolution from the General Meeting of Portugal Telecom, S.A. on April 27, 2000 within the business restructuring process in Portugal Telecom Group and by spin-off from Portugal Telecom, S.A. The conditions for this spin-off were defined under Decree-Law no. 219/00, of September 9, and Joint Order no. 936-A/2000 issued by the Ministers for Social Provision and for Finance on September 14.

On 30 September 2006, under the restructuring process of the Group Portugal Telecom, Portugal Telecom, SGPS, S.A. (“PT SGPS”—Holding company of the Group) sold to PT Portugal, SGPS, S.A. (“PT Portugal”—a sub-Holding company of the Group) all of the shares of PT Comunicações.

On 27 December 2002, PT Comunicações and the Portuguese Government signed the Contract of Purchase and Sale of the Basic Telecommunications Network (“Basic Network”) and the Telex Network, under which the State transferred the full property of the Basic Network and the Telex Network to PT Comunicações, free of any lien or encumbrance. Under the terms of this contract, PT Comunicações is obliged to: i) guarantee the functioning of the Basic Network as an open network, serving as support for the transmission of a general range of services and available to all telecommunications operators and service providers under equal conditions; and ii) provide the acquired network, during the concession period, with the necessary infrastructure for the provision of the concession services and without prejudice to the possibility of its transfer, replacement and/or encumbrance, provided that this does not affect those services.

On 17 February 2003 Decree-Law no. 31/2003 was published, approving the Amendment Agreement to the Concession Contract, which changed the conditions for the concession of public telecommunications services approved by Decree-Law no. 40/95 of February 15. This decree introduced the following fundamental changes to the previous Concession Contract: i) rent payment will no longer be made to the Portuguese State; ii) rights and assets subject to the concession will not revert to the State upon termination; and iii) the State will compensate the Company, under certain compensation mechanisms, for possible negative margins incurred by the Company arising from compliance with the obligations inherent to the provision of the fixed telex, telegraphic and broadcasting services and the mobile marine service.

Under the terms of the above-mentioned Amendment Agreement, the objectives of the concession are: the development and operation of the infrastructure that make up the basic network for telecommunications and signal transmission and emission; the provision of a universal telecommunications service, as defined under Decree-Law no. 458/99, of 5 November; the provision of a telex service; the provision of a data transmission service; the provision of a service for the emission and distribution of telecommunications broadcasts; and the provision of a telegraphic service.

The provision of the universal telecommunications service includes the following: i) connection to the fixed telephone network and access to fixed telephone services; ii) availability of public telephones in public places; and iii) availability of telephone directories and an information service.

The concession period expires in March 2025. As mentioned above, both the Amendment Agreement to the Concession Contract and the Portuguese Law impose certain obligations to PT Comunicações as a universal service provider. On February 2012, following a public hearing about the selection of the universal service provider, Anacom issued a final decision splitting the universal service into three functions: (1) connection to a public communications network in a fixed location and rendering of a telephone service through this network (Tender 1); (2) public phones offer (Tender 2); and (3) make available a complete telephone list and a related service (Tender 3). In 2012, the Portuguese State launched a public tender to select the universal service providers, approved the definition of the universal service cost and established a compensation fund for the universal service providers.

PT Comunicações
Notes to Financial Statements (Continued)
As at 31 December 2013
(Amounts in Euro)

1. Introduction (Continued)

PT Comunicações is qualified to receive compensation from that fund to cover the costs incurred up to date with the universal service. In 2013, the outcome of the tender offer became public, with the universal service related to the fixed line service (tender 1) being attributed to Zon and Optimus. This service is the main purpose of the Concession Agreement, and as such PT Comunicações and the Portuguese State agreed that the Concession Agreement should be terminated, as a result of which PT Comunicações would be entitled to a compensation corresponding to the investments realized in the universal service and not yet amortized as at the termination date.

On 11 February 2004, Law 5/2004 or the “Electronic Communications Act” was published, which establishes the legal regime applicable to electronic communications networks and services, and to the associated resources and services, and defines the authority of the national regulatory agency in this area.

On 9 December 2008, ANACOM attributed to PT Comunicações the rights to the use frequencies, on a national basis, to provide digital television services (TDT) for the broadcasting television programs with unconditional access (also known as public access channels) which is associated with Multiplexer A (Mux A). During the year 2011, ANACOM defined the obligations associated with such rights, and as a result PT Comunicações recognized an intangible asset corresponding to the present value of the commitments under such rights (Note 9).

(b) Corporate transactions

During 2007, PT Comunicações acquired the shares of PT Prime—Enterprise Solutions and Telecommunication Systems, SA (“PT Prime”), PT Corporate—Enterprise Solutions for Telecommunications and Information Systems, SA (“PT Corporate”) and PT.Com—Interactive Communications, SA (“PT.COM”), previously held by PT SGPS, seeking to consolidate all fixed line services into PT Comunicações.

In March 2008, PT.Com and PT Corporate were merged through their incorporation into PT Comunicações and, consequently, the equity, rights and obligations of those companies were transferred to PT Comunicações, and PT.Com and PT Corporate ceased to exist as separate entities.

In July 2009, PT Comunicações acquired from Novabase—Sociedade Gestora de Participações Sociais, SGPS, S.A. (“Novabase”) a 36.25% stake in Superemprego—Sistemas de Informação para a Gestão de Recursos Humanos, S.A. (“Superemprego”), and therefore Superemprego became fully owned by Portugal Telecom Group. In November 2009, Superemprego was merged through its incorporation into PT Comunicações and, consequently, its equity, rights and obligations were transferred to PT Comunicações and Superemprego was ceased to exist as a separate entity.

On 30 November 2010, and considering the need to adjust the corporate structure to reflect the consolidation of its fixed-line and mobile business, PT Comunicações acquired from PT Portugal the full stake in TMN—Telecomunicações Móveis Nacionais, S.A. (“TMN”), company whose name was changed to Meo-. Multimedia Communications and Services, SA (“Meo, SA”) on 27 January 2014. This change aimed to fixed-mobile convergence, so the services of residential and personal segments started to be provided by the same brand.

On 29 December 2011, PT Prime was merged into PT Comunicações through the incorporation of its shareholders’ equity and rights and obligations. For accounting purposes, this merger was reported as of 1 January 2011 and, accordingly, all transactions made by PT Prime as from that date were made on behalf of PT Comunicações.

On 3 May 2012, PT Comunicações concluded the acquisition from TVI—Televisão Independente, S.A. (“TVI”) of its former wholly-owned subsidiary RETI—Rede Teledifusora Independente, S.A. (“RETI”), which therefore became a wholly-owned subsidiary of PT Comunicações (Note 10). On 12 December

PT Comunicações
Notes to Financial Statements (Continued)
As at 31 December 2013
(Amounts in Euro)

1. Introduction (Continued)

2012, RETI was merged into PT Comunicações through the incorporation of its shareholders' equity and rights and obligations. For accounting purposes, this merger was reported as of 3 May 2012 and, accordingly, all transactions made by RETI as from that date were made on behalf of PT Comunicações.

On June 2013, Portugal Telecom concluded the sale of its 28% stake in Companhia de Telecomunicações de Macau, S.A.R.L. (CTM), to CITIC Telecom International Holdings Limited (CITIC Telecom), that included stakes of 25% and 3% owned by PT Participações and PT Comunicações, respectively, for a total amount of USD 443.0 million, equivalent to approximately Euro 335.7 million, having PT Comunicações received the amount of Euro 35,966,391 (Note 4 b) and 20 a)), corresponding to their share capital held in the CTM.

On 17 July 2013, Auto Venda Já, S.A. ("Auto Sapo") was incorporated with a share capital of Euro 50,000. PT Comunicações subscribed and realized an amount of Euro 25,000, corresponding to 50% in the share capital of that entity, and in addition granted paid-in capital in the amount of Euro 150,000 (Note 10). The activity of this entity consists of the acquisition and resale of cars through sales channels that are made available to the owners of those cars, including a sales electronic platform, and all related or complementary services.

On 1 December 2013, PT Comunicações sale 0,005% stake in Portugal Telecom Brasil, S.A. ("PT Brasil") to PT SGPS, and therefore PT Brasil became fully owned by PT SGPS (Note 10).

On 30 December 2013, as part of an internal reorganization of the PT Group, PT Comunicações acquired all the shares that PT SGPS held in a number of companies, including:

- the 50% interest in Sportinveste Multimédia, SGPS, S.A. ("Sportinveste Multimédia"), corresponding to 2,500,000 shares of its share capital, and paid-in capital and loans granted to this entity; the investment in Sportinveste Multimédia was recorded as a non-current asset held for sale, as a result of the ongoing restructuring process of this company (Note 20.b);
- the 33.33% interest in Yunit Services, S.A. ("Yunit"), corresponding to 33,334 shares of its share capital, and the related loans granted to this entity (Notes 10 and 22);
- the 26.36% interest in INESC—Instituto de Engenharia de Sistemas e Computadores, S.A. ("INESC") and the related loans granted to this entity; this interest plus the 9.53% interest that was previously owned by PT Comunicações results in a 35.89% total interest in the share capital of INESC (Note 10);
- the 8.54% interest in Vortal S.G.P.S., S.A. ("Vortal"), corresponding to 474,254 shares of its share capital;
- the 0.0004% interest in Multicert—Serviços de Certificação Electrónica, S.A. ("Multicert"), corresponding to 10 shares of its share capital; this interest plus the 19.9996% interest that was previously owned by PT Comunicações results in a total 20% interest in the share capital of Multicert (Note 10).

(c) Other information

Under the terms of article 7 of Decree-Law no. 158/2009, despite holding financial stakes in group companies and associates, the Company is not required to prepare consolidated financial statements, given that it is indirectly fully held by PT SGPS, which already presents consolidated financial statements which include the financial statements of the Company and its affiliated companies.

2. Basis of presentation

These financial statements were prepared in accordance with Portuguese legislation, based on Decree-law n.º. 158/2009, which approved the new Portuguese accounting system, named Sistema de

PT Comunicações
Notes to Financial Statements (Continued)
As at 31 December 2013
(Amounts in Euro)

2. Basis of presentation (Continued)

Normalização Contabilística (“SNC”), including the conceptual structure, Normas Contabilísticas e de Relato Financeiro (“NCRF”) and Interpretative Standards, as approved by Notices nº 15652/2009, 15655/2009 and 15653/2009, respectively.

The Company adopted NCRF for the first time in 2010 and applied for this purpose the “*NCRF 3 First Time Adoption Of NCRF*” (“NCRF 3”), with the transition date being 1 January 2009 for the purposes of the presentation of these financial statements. Previously, the Company’s financial statements were prepared in accordance with accounting standards as previously in effect in Portugal (Plano Oficial de Contabilidade—“POC”) and other complementary legislation, which were modified by SNC. The conversion adjustments made to the financial statements as at 1 January 2009 were computed retrospectively, as determined by NCRF 3.

As permitted by Decree-Law nº. 158/2009, the Company also applies the International Financial Reporting Standards (“IAS/IFRS”) and related interpretations (“SIC/IFRIC”) issued by International Accounting Standards Board (IASB), in order to fill in the gaps or omissions in SNC regarding specific situations of certain transactions.

3. Main accounting policies, judgments and estimates

These financial statements were prepared assuming the continuity of operations. The main accounting policies used in the preparation of these financial statements are described below and were applied consistently, unless indicated otherwise.

3.1. Tangible fixed assets

Tangible fixed assets other than land and buildings and ducts infrastructure are stated at acquisition or production cost, which includes the purchase price and any expenses directly attributable to bringing the asset to the location and making them operational.

Land, buildings and the ducts infrastructure are presented in accordance with the revaluation model based on regular assessments, at least tri-annually, deducted from subsequent depreciation for buildings and infrastructure. The fair value of real estate properties is determined by external appraisers based on market prices or the income obtained by these assets, under the provisions of NCRF 7 Tangible Fixed Assets. Regarding the ducts infrastructure, the Company, has applied IAS/IFRS by assessing the fair value of these assets based on the depreciated replacement cost method, as this methodology is not provided under NCRF 7. The Company maintained these assets recognized at the revaluation model, although the valuation methodology is not provided under NCRF 7, in order to ensure the consistency with Portugal Telecom’s consolidated financial statements regarding the valuation of this type of asset, through the application of IAS/IFRS.

Subsequent expenses are included in the asset’s carrying amount only when it is probable that future economic benefits flow to the Company and the cost can be measured reliably. The costs of maintenance and repair that are not likely to generate future economic benefits are recognized as an expense in the period they are incurred.

Increases resulting from revaluations are recorded in equity under the caption “Revaluation surplus”, except for increases that reverse a decline previously recognized in earnings. Decreases resulting from revaluations are recorded directly under the caption “Revaluation surplus” up to the credit balance of the revaluation surplus for the relevant asset. Any excess in relation to the relevant credit balance is recognized in earnings. When the revalued asset is written off, the revaluation surplus included in equity regarding the asset is not reclassified to net income and is instead transferred to retained earnings. Annually, the revaluation surpluses are transferred to retained earnings in the same proportion of their depreciation.

PT Comunicações
Notes to Financial Statements (Continued)
As at 31 December 2013
(Amounts in Euro)

3. Main accounting policies, judgments and estimates (Continued)

With the exception of lands that are not depreciated, the depreciation of other tangible fixed assets is recognized, from the month in which the asset is available for use, on a straight-line basis over the useful life of asset, which is determined according to expected utility. The amortization period of tangible assets is reviewed on an annual basis and adjusted in order to reflect the estimated useful lives. The annual rates applied reflect the estimated useful life for each class of assets, as follows:

<u>Asset Class</u>	<u>Years of useful life</u>
Buildings and other constructions	3 - 50
Basic equipment	
Network installations and equipment	7 - 40
Ducts infra-structure	40
Telephones, switchboards and other	4 - 10
Submarine cables	15 - 20
Other basic equipment	4 - 20
Transportation equipment	4 - 8
Administrative equipment	3 - 10
Other tangible fixed assets	4 - 8

Following the approval of the Amendment Agreement to the Concession Contract, concluded in 2003 in connection with the acquisition of the Basic Network from the Portuguese Government, which now provides that the fixed assets related to the concessions will no longer be returned to the Portuguese State after the concession, the Company revised the amortization period of the assets which previously had useful lives that exceeded the term of the Concession Contract.

The useful lives and depreciation methods are reviewed annually, and the effect of any changes to these estimates is recognized prospectively in the income statement.

Gains or losses arising from the write-off or disposal of tangible fixed assets are determined as the difference between the amount received and the net recorded amount of the asset, and are recognized in the income statement.

3.2. Leases

Leases are classified as finance leases whenever the terms of the lease transfer substantially all the risks and rewards of ownership to the lessee. The remaining lease contracts are considered operating leases. The classification of leases depends on the substance of the transaction and not on the form of the contract.

Assets acquired under finance leases and the corresponding liabilities are accounted at the beginning of the contract as the lesser amount between the fair value of the assets and the present value of minimum lease payments. Rents include interest and capital amortisation, with the first being recognized in the income statement in the related period.

Under operating leases, rents are recognized on a straight-line basis during the period of the lease.

3.3. Investment properties

Investment properties includes mainly buildings and land held to earn rent and/or capital appreciation and not for use in the normal course of the business.

Investment properties are stated at acquisition cost plus transaction expenses and reduced by accumulated depreciation and accumulated impairment losses, if any. Expenditures incurred (maintenance, repairs, insurance and real estate taxes) and income and rents obtained are recognized in the income statement of the period.

PT Comunicações
Notes to Financial Statements (Continued)
As at 31 December 2013
(Amounts in Euro)

3. Main accounting policies, judgments and estimates (Continued)

Investment properties are depreciated on a straight-line basis, during their expected useful lives. Generally depreciation rates correspond to the respective estimated useful lives (Note 3.1).

3.4. Business combinations and goodwill

Acquisitions of subsidiaries are recorded based on the purchase method (NCRF 14). The purchase price includes, on the acquisition date, the following components: (a) the fair value of assets acquired; (b) the fair value of liabilities incurred; (c) the fair value of equity instruments issued by the Company in exchange for the control of the subsidiary; and (d) expenses directly attributable to the acquisition. When applicable, the purchase price includes the effect of contingent payments agreed under the transaction, with subsequent changes in those payments being recorded as an adjustment to goodwill.

Any excess of the acquisition cost over the fair value of net assets acquired and contingent liabilities of the acquired company at the date of acquisition is recorded as goodwill, in accordance with NCRF 14. If the acquisition cost is lower than the fair value of identifiable net assets, the difference is recorded as a gain in the net income. As provided for in NCRF 3, the Company will apply NCRF 14 only to acquisitions after 1 January 2009 and accordingly goodwill related to acquisitions prior to that date were maintained as initially computed under POC.

Goodwill resulting from the acquisition of subsidiaries is included in the balance sheet under the caption "Goodwill".

Goodwill is not amortised, but tested, on an annual basis or whenever there is evidence of a potential loss of value, for impairment losses. For impairment test purposes, goodwill is allocated to cash generating units. Any impairment loss is recognized in the income statement of the period, and cannot be reversed in a subsequent period.

3.5. Intangible assets

Intangible assets include mainly (1) the amount for the acquisition of the Basic Network, (2) software licenses, (3) TDT license acquisition cost and (4) satellite capacity rights. Intangible assets acquired separately are recorded at cost net of accumulated amortisation and accumulated impairment losses, if any.

Intangible assets are amortised on a straight-line basis and over a period of three years, except: (a) the value of the acquisition of the property of the Basic Network, which is amortised over the remaining period until the end of the concession (2025), (b) the value of the commitments assumed under the of TDT license, which is amortized until the end of the first renewal period of the same (2038); and (c) the satellite capacity rights, which are amortised over the period of their respective contracts. The useful lives and depreciation method of the intangible assets are reviewed annually, and the effect of any changes to these estimates is recognized prospectively in the income statement.

Expenses with research activities are recognized in earnings when incurred. Development expenses are capitalized when it is demonstrated the technical and economic feasibility of the product, and the Company has the intention and ability to complete its development and starts its commercialization or use, as provided in the "NCRF 6 Intangible Assets".

3.6. Impairment of tangible and intangible assets

The Company performs impairment tests for its tangible and intangible assets if any event or change results in an indication of impairment. In case of any such indication, the recoverable amount of the asset is estimated in order to determine the extent of the impairment loss. When it is not possible to determine the recoverable amount of an individual asset, the estimated recoverable amount of the cash-generating unit to which the asset belongs is used.

PT Comunicações
Notes to Financial Statements (Continued)
As at 31 December 2013
(Amounts in Euro)

3. Main accounting policies, judgments and estimates (Continued)

The recoverable amount is the greater of fair value less cost to sell and the value in use. The net selling price is the amount that could be received from a transaction between independent parties, reduced by direct costs related to the sale. In assessing the value in use, the estimated future cash flows are discounted to their present value using a discount rate that reflects current market assessments of the time value of money and the specific risk to the asset.

If the recoverable amount of an asset is estimated to be less than its carrying amount, an impairment loss is recognized in the income statement.

3.7. Financial investments

Subsidiaries are those entities over which the Company has the power to govern the financial and operating policies generally represented by the majority of the voting rights. Associated companies are entities over which the Company has significant influence but does not control, generally represented by stakes between 20% and 50% of voting rights.

Financial investments in subsidiaries and associated companies are recorded under the equity method of accounting. Under this method, financial investments are initially recorded at acquisition cost and subsequently adjusted for the changes, after the acquisition date, in the Company's share in the net assets of those entities. The entity's earnings include its share in the earnings of those companies.

Under the application of the equity method of accounting, adjustments are made to the financial statements of affiliated companies in order to (1) conform their accounting policies with those adopted by the Company, (2) reflect the impacts of purchase price allocation processes and, (3) eliminate gains and losses resulting from transactions between affiliated companies of PT Comunicações.

Financial investments in foreign entities are translated to Euros using the exchange rates prevailing at the balance sheet date, while the Company's share in the earnings of those entities is computed based on the average exchange rates for the reported period. The effect of translation differences is recognized in shareholders' equity under the caption "Adjustments in financial assets".

The exchange rates used in the translation of the main financial statements of the foreign entities are as follows:

Currency	2013		2012	
	Closing	Average	Closing	Average
Macao Pataca	11.0141	10.6094	10.5328	10.2624
Brazilian Real	3.2576	2.8685	2.7036	2.5084

Financial investments are evaluated whenever there is evidence that it might be impaired, with impairment losses being recorded in the income statement.

3.8. Non-current assets held for sale

Non-current assets are classified as held for sale when its carrying value will be recovered mainly through a sale transaction and not continuing use, which occurs when the sale is highly probable and the non-current asset or disposal group is available for immediate sale in its present condition. The sale should be concluded one year after the non-current asset was classified as held for sale.

Non-current assets held for sale are measured at the lower amount between the carrying value and the fair value less costs to sell.

PT Comunicações
Notes to Financial Statements (Continued)
As at 31 December 2013
(Amounts in Euro)

3. Main accounting policies, judgments and estimates (Continued)

3.9. Post-retirement benefits

(a) Post-retirement pensions

The Company has the obligation to pay to a group of employees a pension supplement. In order to finance these obligations, various funds were incorporated by PT Comunicações (Note 11.1).

In order to estimate the amount of the Company's liabilities under these pension plans, the Company obtains periodically actuarial valuations, using the "Projected Unit Credit Method". As mentioned above, according to "NCRF 28—Employee Benefits" and "IAS 19—Employee Benefits", PT Comunicações has decided to adopt the alternative treatment referred in IAS 19 for recognition of actuarial gains and losses directly in equity, namely those resulting from changes in actuarial assumptions and from differences between actual data and actuarial assumptions.

Plan amendments related to reduction or increase of the benefits granted to employees are recorded as prior years' service gains or losses. Prior years' service gains or losses are recognized under the caption "Costs with post-retirement benefits" when they occur. Gains obtained with the settlement of any plan are recognized when incurred under the caption "Curtailement and settlement costs".

Liabilities stated in the balance sheet correspond to the difference between the Projected Benefit Obligation ("PBO") related to pensions deducted from the fair value of fund assets.

For the plans that report an actuarial surplus, assets are recorded when there is an express authorization for offsetting them against future employer contributions, or if a reimbursement of the excess finance is expressly authorized or permitted.

Contributions made by the Company to defined contribution pension plans are recognized in net income when incurred.

(b) Health care benefits

Under a defined benefit plan, PT Comunicações is responsible to pay, after the retirement date, health care expenses to a group of employees and relatives. This health care plan is managed by Portugal Telecom—Associação de Cuidados de Saúde ("PT-ACS"). In 2004, the Group established PT Prestações—Mandatária de Aquisições e Gestão de Bens, S.A. ("PT Prestações") to manage an autonomous fund to finance these obligations (Note 11.2).

The amount of the Company's liabilities with respect to these benefits after the respective retirement date is estimated based on actuarial valuations, using the "Projected Unit Credit Method". The Company recognises actuarial gains and losses directly in equity, namely those resulting from changes in actuarial assumptions and from differences between actual data and actuarial assumptions.

Plan amendments related to reduction or increase of the benefits granted to employees are recorded as prior years' service gains or losses under the caption "Post-retirement benefit costs". Gains obtained with the settlement of any plan are recognized when incurred under the caption "Curtailement and settlement costs".

Accrued post-retirement health care liabilities stated in the Balance sheet correspond to the present value of obligations from defined benefit plans, deducted from the fair value of fund assets and any prior years' service gains or losses not yet recognized.

(c) Pre-retired and suspended employees

In connection with the programs related to employees that are under a suspended contract agreement or that have been pre-retired, the Company recognises a liability in the balance sheet equivalent to the

PT Comunicações
Notes to Financial Statements (Continued)
As at 31 December 2013
(Amounts in Euro)

3. Main accounting policies, judgments and estimates (Continued)

present value of salaries payable up to the retirement age. The related cost is recorded in the income statement under the caption "Curtailement and settlement costs" (Note 11.3).

3.10. Accruals and deferrals

The Company records its revenue and expenses as they are generated or incurred, regardless of when they are received or paid, respectively.

3.11. Income taxes

Income tax expense corresponds to the sum of current and deferred taxes. Deferred taxes are recognized in the income statement except when they relate to items recorded directly in shareholders' equity and accordingly are also recorded in shareholders' equity.

Current taxes are computed based on the taxable income of the period computed under the Corporate Income Tax ("IRC").

Portugal Telecom adopted the special taxation regime for Groups of companies, in which PT Comunicações is included. Consequently, the income tax due, net of withholding taxes and payments on accounts are recorded on the balance sheet as accounts payable or receivable from Portugal Telecom.

The income tax recorded in the financial statements was assessed in accordance with the terms of "NCRF 25 Income Taxes". In assessing the cost of income tax for the year, besides the current tax determined on the basis of profit before-tax adjusted in accordance with the tax legislation, we also consider the effects resulting from temporary differences between the carrying value of assets and liabilities and the related tax amounts. Deferred tax assets and liabilities are computed and analysed annually, based on the expected tax rate that will be effective on the date on which such temporary differences are no longer applicable.

Deferred tax assets are recorded only when there is a reasonable expectation of sufficient future tax profits. As at the balance sheet date the Company conducts a reassessment of the above-mentioned temporary differences with respect to the deferred tax assets, in order to record deferred tax assets that were not recognized previously because they had not met the necessary conditions for their recognition, and/or reduce the amount of deferred tax assets which are recognized based on the current estimate of their future recoverable amounts.

3.12. Inventories

Inventories are stated at average acquisition cost. Adjustments to the carrying value of inventories are recognized based on technological obsolescence or low rotation.

Work in progress relating to installation of telecommunication equipments for clients is valued at production cost, which mainly includes expenses on equipment and various materials used, as well as wages and salaries related to the project.

Impairment losses on inventories includes the value of materials for which there is no intended use due to obsolescence and/or low rotation, as well as the difference between prices of materials that have a fair value lower than the average acquisition cost, when the difference is higher than the discount granted in current market conditions. Impairment losses and related reversals are recorded in earnings primarily under the caption "Impairment of inventories ((losses)/reversals)".

PT Comunicações
Notes to Financial Statements (Continued)
As at 31 December 2013
(Amounts in Euro)

3. Main accounting policies, judgments and estimates (Continued)

3.13. Trade receivables and other

Trade receivables and other receivables are initially recognized at fair value and subsequently measured at cost or amortised cost, based on the effective interest method, deducted from impairment losses.

Impairment losses for doubtful accounts receivable are computed based on the evaluation of estimated risks resulting from the non-collection of receivables, and are recognized in the income statement of the period in which they are calculated.

3.14. Subsidies

Subsidies are only recognized when they are received and after reasonable assurance that the Company will comply with their respective requirements for their assignment.

Subsidies associated with the acquisition or production of non-current assets (investment subsidies) are initially recognized in equity under the caption "Other shareholders' equity", and subsequently allocated on a straight-line basis as income for the year, during the useful lives of the assets to which they relate.

Operating subsidies are recognized in the income statement on a constant basis over the periods in which expenses that they intended to compensate are recognized.

3.15. Provisions and contingent liabilities

Provisions are recognized when (i) there is a present obligation as a result of a past event, (ii) it is probable that an outflow of resources embodying economic benefits will be required to settle the obligation and (iii) a reliable estimate can be made of the amount of the obligation. Where any of the above-mentioned criteria is not met, the Company discloses the event as a contingent liability, unless the chance of cash outflow is remote.

Provisions are recognized for an amount corresponding to the present value of the best available estimate, at the reporting date, of the resources required to settle the obligation. That estimate is determined considering the risks and uncertainties associated with the obligation. Provisions are reviewed at the end of each year and adjusted in order to reflect the best available estimate as of that date.

The present obligations arising from onerous contracts (in which the cost of meeting the obligations under the contract exceed the economic benefits expected there under) are calculated and recorded as provisions.

3.16. Loans obtained

Loans obtained are initially recognized at fair value, net of transaction costs incurred, and subsequently presented at amortised cost, based on the effective interest method.

3.17. Borrowing costs

The Company has the policy of capitalizing of borrowing costs related to loans obtained to finance the acquisition, construction or production of tangible assets. However, the Company has recognized borrowing costs as expenses when incurred, since the construction period of tangible assets is usually short.

3.18. Vacation pay and vacation subsidies

Vacation pay and vacation subsidies and related social charges are recorded as a cost for the period in which the employee acquires the right to receive them. Consequently, the amount of vacation pay and

PT Comunicações
Notes to Financial Statements (Continued)
As at 31 December 2013
(Amounts in Euro)

3. Main accounting policies, judgments and estimates (Continued)

subsidies and related social charges due and unpaid at the balance sheet date are estimated and included under the caption “Accrued expenses”.

3.19. Balance classification

Realizable assets and liabilities under which the Company has an unconditional right to defer its settlement for a period over one year from the balance sheet date are classified under non-current assets and non-current liabilities, respectively, at present value.

3.20. Foreign currency transactions and balances

Transactions denominated in foreign currencies (different from the domestic currency of the Company) are recorded at the exchange rates prevailing at the time the transactions are made. Assets and liabilities in foreign currency for which there is no agreement for fixing an exchange rate are translated to Euros using the exchange rates prevailing at the balance sheet date. Gains or losses arising from the differences between exchange rates in force at the date of the respective transactions and those applying on the date of collection, payment or balance sheet date are recorded as income and losses, respectively, in the income statement.

Assets and liabilities as at 31 December 2013 and 2012 were translated to Euro using the following exchange rates reported by the Bank of Portugal:

<u>Currency</u>	<u>2013</u>	<u>2012</u>
Special Drawing Rights	1.1173	1.1658
American dollar	1.3791	1.3194
Namibian dollar	14.5660	11.1727
Cape Verde escudo	110.2650	110.2650
Swiss franc	1.2276	1.2072
Angolan Kwanza	134.5920	126.8460
British pound	0.8337	0.8161
Mozambique metical	41.2400	39.2400
Brazilian real	3.2576	2.7036

3.21. Revenue recognition

Revenue is measured at fair value of the amount received or receivable. Revenue recognition is deducted from the estimated amount of returns, discounts and other rebates and does not include the Value Added Tax (VAT) and other taxes paid related to the sale.

Revenue from the services rendered is recognized by reference to the stage of completion of the transaction at the reporting date, if all the following conditions are met: (1) the revenue amount can be reliably measured; (2) it is probable that future economic benefits associated with the transaction will flow to the Company; (3) the expenses incurred or to be incurred with the transaction can be measured reliably; and (4) the stage of completion of the transaction at the reporting date can be reasonably estimated.

(a) National fixed national communications

Revenues from telecommunication activities are recognized at their gross amounts when services are rendered. Billings for these services are made on a monthly basis throughout the month. Amounts not yet invoiced but already due or incurred are recorded based on estimates and included under the caption “Unbilled revenues”. Differences between accrued amounts and the actual unbilled revenues are recognized in the following period.

PT Comunicações
Notes to Financial Statements (Continued)
As at 31 December 2013
(Amounts in Euro)

3. Main accounting policies, judgments and estimates (Continued)

(b) International fixed communications

The income from international telecommunication services are calculated according to fixed termination rates under bilateral agreements with several telecom operators. These agreements also establish whether it is the operator of the sending network that must submit the credit to the operator of the receiving network or whether the operator of the network receiving must provide the debit first.

(c) Internet Protocol Television (“IPTV”) and Direct to Home (“DTH”) services

The income from the television service through Internet Protocol Television (IPTV) and satellite are recognized as follows: (i) the amounts charged for monthly subscription of services used are recognized in the period in which the service is rendered; (ii) equipment rental is recognized over the lease period; (iii) equipment sales are recognized upon sale; and (iv) penalties imposed to customers are recognized when received.

(d) Internet services

Revenues from ISP services result essentially from monthly subscription fees and telephone traffic when the service is used by customers. These revenues are recognized when the service is rendered.

(e) Advertising services

Advertising revenues from telephone directories and related costs are recognized in the period in which the directories are effective. PT Comunicações has a contract with Páginas Amarelas whereby the latter is responsible for production, publishing and distribution of PT Comunicações telephone directories, as well as for selling advertising space in the directories. The total cost to be paid by PT Comunicações for such services is set at a fixed 78% of its gross revenues from the sale of advertising space in telephone directories. The prices of advertising space are fixed, not contingent, and based on the expected volume of the distributed directories (approximately one to every telephone number). Revenues from the sale of advertising space are invoiced directly by PT Comunicações to its corporate clients during the one-year advertising period. These revenues are recognized in earnings on a monthly basis during the period for the respective directory.

(f) Leased lines and rental of ducts and capacity

Income from leased lines is recorded as operating leases in the respective period, under the caption “Services rendered”.

(g) Interest

Interest revenue is recognized based on the effective interest method.

Income relative to advance payments made by customers are deferred and recognized when the service is rendered.

3.22. Own work capitalized

Internal expenses incurred by the Company in the construction of tangible fixed assets, which correspond to materials, work force and transportation, at cost, are capitalized under the caption “Own work capitalized”, only when the following requirements are met: (a) the tangible fixed assets are identifiable; (b) the tangible fixed assets will generate future economic benefits; and (c) development expenses can be reliably measured.

PT Comunicações
Notes to Financial Statements (Continued)
As at 31 December 2013
(Amounts in Euro)

3. Main accounting policies, judgments and estimates (Continued)

3.23. Losses and gains recognised under projects

The Company records losses and gains associated with projects based on their stage of completion. Accordingly, invoices issued related to work not yet performed are recorded under the caption “Deferrals”, unbilled revenues related to work in progress are recorded under the caption “Unbilled revenues” and expenses related to unbilled performed work are recorded as work in progress under the caption “Inventories”.

3.24. Financial assets and liabilities

Financial assets and liabilities are recognized in the balance sheet when the Company becomes party to the corresponding contractual terms, and are classified at cost or amortised cost.

(a) Financial assets and liabilities at cost or amortised cost

Assets and liabilities are classified at cost or amortised cost if they present the following characteristics: (a) have a defined maturity; (b) have a fixed or determined income; and (c) do not represent a derivative financial instrument or do not include a derivative financial instrument.

Assets and liabilities classified in this category are measured at amortised cost reduced by accumulated impairment losses (for financial assets) and correspond primarily to the following asset and liability captions included in the Company’s balance sheet:

- Accounts payable to Group companies
- Accounts receivable—trade
- Unbilled revenues and accrued expenses
- Advances to suppliers and from accounts receivable
- State and other public entities
- Other accounts receivable and payable
- Other financial assets and liabilities
- Cash and bank deposits
- Loans obtained
- Suppliers and investments suppliers

Amortized cost is determined through the effective interest method. The effective interest rate is the one that discounts the estimated future payments and receipts until the term of the financial instrument to the carrying value of the financial asset or liability.

(b) Impairments on financial assets

Financial assets included under the caption “cost or amortised cost” are subject to impairment tests at each year end. Such assets are impaired when there is clear evidence that, as a result of one or more events occurred after its initial recognition, their future estimated cash flows will be negatively affected.

For assets measured at amortised cost, the impairment loss corresponds to the difference between the carrying amount of the asset and the present value of the revised future estimated cash flows discounted using the initial effective interest rate. For financial assets measured at cost, the impairment loss corresponds to the difference between the carrying amount of the asset and the best available estimate of the asset’s fair value.

PT Comunicações
Notes to Financial Statements (Continued)
As at 31 December 2013
(Amounts in Euro)

3. Main accounting policies, judgments and estimates (Continued)

Subsequently, if there is a reduction in the impairment loss as a result of an event occurring after the initial recognition of the loss, the impairment should be reversed through earnings. The reversal is recognized up to the amount that would be recorded if the loss had not been initially recognized.

Impairment losses and related reversals are recorded in earnings mainly under the captions "Impairment of accounts receivable ((losses)/reversals)".

(c) Derecognition of financial assets and liabilities

The Company derecognizes financial assets when its contractual rights to obtain the asset's cash flows expire, or when it transfers to another entity all the significant risks and rewards associated with the ownership of such assets. We also derecognize financial assets transferred in respect to which the Company has retained some significant risks and benefits, in the case that control over them has been assigned. The Company derecognizes financial liabilities only when the corresponding obligation is settled, cancelled or expired.

3.25. Main accounting estimates and judgements

To prepare the standalone financial statements under NCRF, the Company's Board of Directors uses estimates and assumptions that affect in the application of accounting policies and the amounts reported. Estimates and judgements are continually evaluated and are based on historical experience and on other factors including expectations of future events that are believed to be reasonable under the circumstances on which the estimate was based, or as a result of new information or more experience.

The most significant accounting estimates reflected in the financial statements are the following:

(a) Post-employment benefits

The present value of liabilities for post-employment benefits is calculated based on actuarial methodologies, which use certain actuarial assumptions that are reviewed annually by the Company. Any change in these assumptions will impact the carrying value of liabilities. The main assumptions used are described in Note 11.

(b) Analysis of goodwill impairment

The Company tests annually whether goodwill has suffered any impairment. The recoverable amounts of cash-generating assets are determined based on value-in-use calculations. The use of this method requires the estimate of future cash flows expected to arise from the continuing operation of the cash generating asset, the choice of a growth rate to extrapolate cash flow projections and the estimate of a suitable discount rate for each cash generating asset. The main assumptions used in the goodwill analysis are disclosed in Note 8.

(c) Useful life of tangible fixed assets

The Company used estimates in order to determine to the useful life of tangible fixed assets.

(d) Provisions recognition

The Company is party to several legal proceedings in progress for which, based on the opinion of its lawyers, judgments are made to determine the recognition of any necessary provisions to meet these contingencies.

PT Comunicações
Notes to Financial Statements (Continued)
As at 31 December 2013
(Amounts in Euro)

3. Main accounting policies, judgments and estimates (Continued)

(e) Impairment recognition

Impairment on accounts receivable are calculated mainly based on receivables seniority, the clients risk profile and their financial situation.

(f) Determining the fair value of assets measured by revaluation model

The Company uses the revaluation model to measure the book value of the asset classes “Land and natural resources”, “Buildings and other constructions” and the “Telecommunication infrastructure” included under the caption “Basic equipment” under tangible fixed assets. In order to assess the fair value of real estate properties included under the assets classes “Land and natural resources” and “Buildings and other constructions”, the Company uses external appraisers to determine their value based on certain specific indicators related to the real estate market. In order to assess the revalued amount of the asset class “Telecommunication infrastructure”, the Company applied the cost replacement method based on current and observable prices of materials and construction work related to the installation underground of the telecommunication infrastructure.

Estimates used are based on the best information available during the preparation of financial statements, although future events, neither controlled nor foreseeable by the Company, could occur and have an impact on those estimates. In accordance with “NCRF 4 Accounting Policies, Changes in Estimates and Errors” (“NCRF 4”), changes to these estimates that occur after the date of the financial statements are recognized in net income, using a prospective methodology. For this reason and given the degree of uncertainty, real results of the transactions in question may differ from the corresponding estimates.

3.26. Events occurred after the balance sheet date

Events after the balance sheet date that provide additional information about conditions existing at the balance sheet date are reflected in the financial statements. Events after the balance sheet date that provide information about conditions that occur after the balance sheet date are not reflected in the financial statements, but are disclosed in the notes to the financial statements, if material.

4. Cash flows

For the purposes of the cash flow statement, the caption “Cash and cash equivalents” includes cash, bank deposits immediately available and other short-term investments with high liquidity and with initial maturities up to three months, net of bank overdrafts.

The Company is exposed to a liquidity risk if its sources of funding, including cash balance, operating cash inflows, divestments and cash flows obtained from financing operations, do not match with our financing needs, such as operating and financing outflows, investments, shareholder remuneration and debt repayments. Based on the cash flows generated by its operations, on the available cash and in the possibility to obtain financing from Portugal Telecom under the centralized cash management system implemented in the Group, the Company believes that it is able to meet its obligations.

The cash flow statement was prepared in accordance with “NCRF 2 Statement of Cash Flows”, which includes the following:

(a) Cash receipts of income taxes

The Company is part of the special taxation regime for Groups of companies adopted by Portugal Telecom, and as such income taxes and withholding taxes by third parties are recorded on the balance sheet as payables and receivables from Portugal Telecom (Note 12). In this context, the Company paid in 2013 an amount of Euro 6,289,893 and received in 2012 an amount of Euro 35,940,339.

PT Comunicações
Notes to Financial Statements (Continued)
As at 31 December 2013
(Amounts in Euro)

4. Cash flows (Continued)

As a result of the merger of PT Prime company undertaken at the end of 2011, effective as from 1 January, and because PT Comunicações presented a tax loss in 2011, the Company recovered in 2012 the payments on account made by PT Prime in 2011, amounting to Euro 38,662,510, which explains the high amount received in 2012.

(b) Cash receipts resulting from the disposal of financial investments

In 2013, this caption includes basically the proceeds obtained from the disposals of the investments in CTM and PT Brasil, amounting to Euro 35,966,391 and Euro 8,869, respectively (Note 10) and the amount of Euro 500,000 which refers to the last part related with the disposal of the investment in WT Vision achieved in 2009.

(c) Cash receipts resulting from loans granted

In 2013, this caption relates to reimbursement, amounting to Euro 340,000,000 (Note 12.1), regarding loans granted in prior years to MEO, SA.

(d) Dividends received

In 2013 and 2012, PT Comunicações received dividends from the following companies:

	<u>2013</u>	<u>2012</u>
	Euro	
CTM ⁽ⁱ⁾	2,703,029	2,625,352
Meo, SA (Nota 10)	—	235,479,275
Multicert—Serviços de Certificação Electrónica, S.A. (Nota 10)	—	117,198
Infonet Portugal—Serviços de Valor Acrescentado, Lda. (Nota 10)	—	51,328
	<u>2,703,029</u>	<u>238,273,153</u>

(i) The amounts received from this affiliated company differed from the attributable amounts of Euro 2,759,950 in 2013 and Euro 2,700,796 in 2012 (Note 10), as a result of exchange rate differences between the attribution and payment dates.

PT Comunicações
Notes to Financial Statements (Continued)
As at 31 December 2013
(Amounts in Euro)

4. Cash flows (Continued)

(e) Payments resulting from financial investments

In 2013 and 2012, this caption is composed as follows:

	2013	2012
	Euro	
Acquisition of Sportinveste Multimédia (Note 20)	32,618,669	—
Acquisition of Yunit (“Yunit”) (Note 1 b))	2,228,329	—
Constitution of Auto Sapo joint venture (Note 10)		
—Realization of share capital	25,000	—
—Additional paid capital contributions	150,000	—
Advances for the aquisition of RETI (Note 10)	—	1,094,382
Acquisition of Fibroglobal—Comunicações Electrónicas, S. A. (“Fibroglobal”) ⁽ⁱ⁾	—	1,000,000
Acquisition of PT Blueclip—Serviços de Gestão, S. A. (“PT Blue Clip”) (Note 10)	—	50,000
Other	10	15,990
	35,022,008	2,160,372

(i) During the year 2012, PT Comunicações subscribed a share capital increase of this company for a total amount of Euro 1,000,000, a result of which obtained a 5% interest in Fibroglobal, which was recorded under the caption “Financial investments—other methods”.

(f) Cash receipts (payments) related to loans obtained

In 2013 and 2012, cash receipts from loans obtained, net of cash payments from loans obtained, has the following composition:

	2013	2012
	Euro	
Receipts (payments) obtained under commercial paper programmes	(592,000,000)	1,092,000,000
Loans granted by PT Portugal (Note 23.1)	252,000,000	—
Intercompany loans within centralized cash management	224,360,440	(472,161,084)
Leases and other loans obtained	(16,650,977)	(21,390,512)
Payments to the “Caixa Geral de Aposentações” ⁽ⁱ⁾	—	(454,316,000)
	(132,290,537)	144,132,404

(i) As at 31 December 2010 and following the transfer of unfunded regulatory pension obligations, the Company had recognized an account payable to the Portuguese State for the amount of Euro 921.7 million. Of this outstanding amount, the Company repaid Euro 17.4 million and Euro 450.0 million in January and December 2011, respectively, and the remaining amount due of Euro 454.3 million was repaid in December 2012.

(g) Cash and cash equivalents

In 2013 and 2012, this caption is composed as follows:

	2013	2012
	Euro	
Cash	1,078,695	14,669,035
Bank deposits immediately available	20,658,318	6,496,946
Cash and bank deposits	21,737,013	21,165,981

PT Comunicações
Notes to Financial Statements (Continued)
As at 31 December 2013
(Amounts in Euro)

5. Changes in accounting policies and estimates and errors

During the year ended 31 December 2013, the Company adopted the revised version of IAS 19 *Employee Benefits* ("IAS 19"), issued in June 2011 and applicable for years beginning on or after 1 January 2013. The revised version of this standard was adopted since the Portuguese local standard NCRF 28 *Employee Benefits* states that the accounting for post-retirement defined benefits should be based on IAS 19.

As a result of the adoption of the amendments to IAS 19, the tables below present the adjustments made to the previously reported Statements of Financial Position for the year ended 31 December 2012:

Balance sheet as at 31 December 2012

	Prior to IAS 19 amendment	Impacts of IAS 19 amendment	Restated balance sheet
	euros		
ASSETS			
Deferred tax assets	314,293,512	(3,549,714)	310,743,798
Other assets	14,394,053,900	—	14,394,053,900
Total assets	14,708,347,412	(3,549,714)	14,704,797,698
SHAREHOLDERS' EQUITY			
Other reserves	269,718,396	26,052,827	295,771,223
Retained earnings	(350,665,937)	(10,975,041)	(361,640,978)
Net (loss) / income	(86,901,669)	(4,428,645)	(91,330,314)
Other shareholders' equity	5,668,212,615	—	5,668,212,615
Total shareholders' equity	5,500,363,405	10,649,141	5,511,012,546
LIABILITIES			
Post retirement benefits	844,921,754	(14,198,855)	830,722,899
Other liabilities	8,363,062,253	—	8,363,062,253
Total liabilities	9,207,984,007	(14,198,855)	9,193,785,152
Total liabilities and shareholders' equity	14,708,347,412	(3,549,714)	14,704,797,698

Income statement for the period ended 31 December 2012

	Prior to IAS 19 amendment	Impacts of IAS 19 amendment	Restated statement
	euros		
Services rendered	1,749,171,088	—	1,749,171,088
Sales	25,146,653	—	25,146,653
Post retirement benefits costs	(51,716,640)	(5,612,380)	(57,329,020)
Curtailment costs	(867,969)	(292,480)	(1,160,449)
Other operating expenses, net	(1,006,108,804)	—	(1,006,108,804)
INCOME BEFORE DEPRECIATION AND AMORTISATION, FINANCING EXPENSES AND TAXES			
	715,624,328	(5,904,860)	709,719,468
Depreciation and amortisation ((losses)/ reversals)	(497,654,649)	—	(497,654,649)
Interest and related expenses, net	(305,739,595)	—	(305,739,595)
Income taxes	868,247	1,476,215	2,344,462
Net income	(86,901,669)	(4,428,645)	(91,330,314)

PT Comunicações
Notes to Financial Statements (Continued)
As at 31 December 2013
(Amounts in Euro)

5. Changes in accounting policies and estimates and errors (Continued)

In 2013, in addition the above mentioned, the Company did not adopt any new or revised standard or interpretation and did not voluntarily change any other accounting policy, and no restatements of any material errors or significant changes in accounting estimates were made with respect to previous years.

6. Tangible fixed assets

6.1. Movements in tangible fixed assets

During the years ended 31 December 2013 and 2012, movements occurred in tangible fixed assets were as follows:

	2013								Total
	Land and natural resources	Buildings and other constructions	Basic equipment	Transportation equipment	Administrative equipment	Other tangible fixed assets	Tangible fixed assets in progress	Advances to suppliers of assets	
	Euro								
Gross value									
Opening balance . . .	177,472,511	851,287,703	8,986,844,412	48,003,165	833,992,690	56,927,979	93,271,169	562,661	11,048,362,290
Acquisitions	9,477	2,758,641	253,738,657	6,285,577	20,945,471	329,584	49,220,847	—	333,288,254
Disposals	(488,338)	(2,501,788)	(2,521,540)	(2,180,702)	(163,857)	(1,343)	—	—	(7,857,568)
Transfers and write-offs	(333,089)	(2,807,627)	(79,670,606)	(6,628,106)	16,886,644	(572,732)	(53,053,815)	—	(126,179,331)
Closing balance . . .	176,660,561	848,736,929	9,158,390,923	45,479,934	871,660,948	56,683,488	89,438,201	562,661	11,247,613,645
Accumulated depreciation and impairment losses									
Opening balance . . .	9,732,669	467,304,995	6,913,921,393	33,482,364	755,136,578	55,083,105	—	—	8,234,661,104
Depreciation of the period (Note 34) . . .	—	33,751,392	353,831,574	3,829,365	56,580,131	610,580	—	—	448,603,042
Disposals	(44,103)	(1,697,784)	(2,362,750)	(2,062,488)	(110,915)	(1,343)	—	—	(6,279,383)
Transfers and write-offs	115,018	(4,763,850)	(104,848,756)	(5,237,762)	(1,807,272)	(572,731)	—	—	(117,115,353)
Closing balance . . .	9,803,584	494,594,753	7,160,541,461	30,011,479	809,798,522	55,119,611	—	—	8,559,869,410
Net value	166,856,977	354,142,176	1,997,849,462	15,468,455	61,862,426	1,563,877	89,438,201	562,661	2,687,744,235
	2012								
	Land and natural resources	Buildings and other constructions	Basic equipment	Transportation equipment	Administrative equipment	Other tangible fixed assets	Tangible fixed assets in progress	Advances to suppliers of assets	Total
	Euro								
Gross value									
Opening balance . . .	176,915,964	843,331,948	8,811,120,172	43,405,353	788,963,712	56,033,699	114,855,017	511,125	10,835,136,990
Reti merger	—	604,699	2,997,334	71,479	—	214,812	—	—	3,888,324
Acquisitions	—	2,680,951	305,153,091	8,977,802	19,113,595	699,219	49,391,694	—	386,016,352
Disposals	(8,831)	—	(3,838,998)	(2,135,330)	(366,729)	(528)	—	—	(6,350,416)
Transfers and write-offs	565,378	4,670,105	(128,587,187)	(2,316,139)	26,282,112	(19,223)	(70,975,542)	51,536	(170,328,960)
Closing balance . . .	177,472,511	851,287,703	8,986,844,412	48,003,165	833,992,690	56,927,979	93,271,169	562,661	11,048,362,290
Accumulated depreciation and impairment losses									
Opening balance . . .	9,819,238	434,943,739	6,703,947,454	31,395,467	693,824,624	54,256,141	—	—	7,928,186,663
Reti merger	—	503,007	1,140,012	71,479	—	208,553	—	—	1,923,051
Depreciation of the period (Note 34) . . .	—	35,801,344	362,087,366	5,376,746	62,910,358	665,788	—	—	466,841,602
Disposals	(1,406)	—	(2,570,127)	(1,829,584)	(294,195)	(528)	—	—	(4,695,840)
Transfers and write-offs	(85,163)	(3,943,095)	(150,683,312)	(1,531,744)	(1,304,209)	(46,849)	—	—	(157,594,372)
Closing balance . . .	9,732,669	467,304,995	6,913,921,393	33,482,364	755,136,578	55,083,105	—	—	8,234,661,104
Net value	167,739,842	383,982,708	2,072,923,019	14,520,801	78,856,112	1,844,874	93,271,169	562,661	2,813,701,186

The additions occurred in 2013 and 2012 under the captions “Basic equipment”, “Administrative equipment” and “Tangible fixed assets in progress” relate primarily to the acquisition of software, network infrastructure and terminal equipment focused mainly on the Pay-TV business.

PT Comunicações
Notes to Financial Statements (Continued)
As at 31 December 2013
(Amounts in Euro)

6. Tangible fixed assets (Continued)

6.2. Revaluations

In 2008, PT Comunicações has changed the accounting policy on the valuation of real estate assets and ducts infra-structure, from the cost model to the revaluation model. The revaluations of real estate assets and ducts infra-structure were recorded as at 30 June and 30 September 2008 and resulted in the revaluation of those assets by Euro 208,268,320 and Euro 866,764,702, respectively. PT Comunicações, following the adoption of the SNC, maintained the accounting policy to use the revaluation model for these classes of assets, under which shall compute revaluation amounts, at maximum, every three years, and evaluates between those 3 year periods the possible existence of evidence that might result in a significant change in the revalued amount of those assets.

The determination of the fair value of real estate properties was made by an independent appraiser based primarily on: (i) observable prices of recent market transactions in an active market; (ii) profitability method for commercial and administrative real estate; and (iii) the cost of acquiring or producing similar real estate with the same purpose for technical buildings. Under the first methodology, the main assumptions used in 2008 were the discount rate (average of 8%) and the monthly rent per square meter (average of Euro 6).

The determination of the fair value of the ducts infra-structure was made internally based on the replacement cost approach. This valuation process was based primarily on: (i) current and observable prices of materials and construction work related to the installation of the ducts underground; (ii) the nature of the soil and road surface where ducts are installed, which has an impact on the construction cost; (iii) internal costs directly attributable to the construction of the ducts infra-structure network; (iv) a depreciation factor, in order to ensure that the replacement cost is consistent with the remaining useful life of the assets revalued; and (v) a technological factor, which reflects the technological changes occurred, namely related to the kinds of ducts which no longer exist and were replaced by other ones. Generally, the prices of materials and construction work together with other qualitative assumptions referred to above resulted in a valuation of the ducts infra-structure in 2008 which reflects an average cost per meter of duct between Euro 58 and Euro 119, depending on the area where the infra-structure is located.

In accordance with the Company's accounting policy to revalue these assets every three years, PT Comunicações performed another revaluation of the real estate assets and transmission infrastructure in 2011, through the same methodology described above. These revaluations were effective as at 31 December 2011 and resulted in a net reduction of tangible assets amounting to Euro 131,418,996, of which Euro 126,167,563 was recognized directly in shareholders' equity, under the caption "Revaluation surplus", and an impairment loss of Euro 5,251,433 was recognized in earnings.

The split of these impacts between real estate and telecommunication ducts infrastructure is as follows:

- A reduction in the carrying value of the telecommunication infrastructure amounting to Euro 189,372,570, recognized directly in shareholders' equity in order to reduce the existing revaluation reserves regarding these assets, which is primarily explained by a decrease in the construction cost and also technological improvements, leading to a reduction in the average cost per meter of duct to between Euro 42 and Euro 70, depending on the area where the infra-structure is located; and
- A net increase in the carrying value of real estate assets amounting to Euro 57,953,574, including a gain of Euro 63,205,007 recorded directly in shareholders' equity and a loss of Euro 5,251,433 recognized in the Income Statement. The increase in the carrying value of real estate assets recognized as a result of this revaluation reflects mainly the depreciation expenses recorded over the last three years, which more than offset the reduction in the fair value of these assets. Regarding the main assumption related to this revaluation, the average monthly rent per square meter for the real estate assets that were revalued in both 2008 and 2011 remained broadly stable at Euro 6,

PT Comunicações
Notes to Financial Statements (Continued)
As at 31 December 2013
(Amounts in Euro)

6. Tangible fixed assets (Continued)

although the overall average monthly rent per square meter increased to Euro 7, as a result of real estate assets acquired in 2009 and 2010.

The amortization of the surplus resulting from the revaluation of real estate properties and ducts infrastructure amounted to approximately Euro 9 million and Euro 32 million in 2013, respectively, and to Euro 10 million and Euro 32 million in 2012, respectively. If these assets had been carried under the cost model, the carrying amounts of the real estate properties and the ducts infrastructure as of 31 December 2013 would have been reduced by approximately Euro 178 million and Euro 466 million, respectively.

For other classes of assets that were previously revalued to the date of transition to NCRF, the Company opted, under the adoption of new accounting standards, to consider the book value at the date of transition as deemed cost, as permitted by the exception foreseen in paragraph 10 of NCRF 3, so that these assets are measured according to the cost model.

In accordance with the applicable legislation, a portion (40%) of the increase in depreciation resulting from legal revaluations made in previous years, and the entire increase in depreciation resulting from revaluations recognized in 2008 do not constitute a cost for the purpose of determining corporate income tax payable (except the revaluations resulting from Decree-Law no. 126/77 of April 2, which are included in their entirety). Consequently, a deferred tax liability was recorded corresponding to the revaluation surplus to be realized (Note 15).

6.3. Other situations related to tangible fixed assets

During the years ended 31 December 2013 and 2012, the following expenses were included in the carrying value of tangible assets and intangible assets in progress:

	<u>2013</u>	<u>2012</u>
	Euro	
Materials consumed	4,062,335	3,094,392
Wages and salaries	39,920,165	33,646,133
Other expenses and losses	5,654,791	5,323,514
	<u>49,637,291</u>	<u>42,064,039</u>

The nature of the main projects that include own work capitalized relates to the planning, supervision and monitoring of installation of terminal equipment, namely IPTV equipment and Fiber-to-the-Home (“FTTH”).

For the net carrying value of tangible fixed assets as at 31 December 2013, we note the following:

- There are buildings installed in properties of third parties in the total amount of Euro 7,761,392;
- There are assets of PT Comunicações composed mainly of real estate, that were not registered under the Company’s name amounting to Euro 8,598,796, of which Euro 1,503,353 are registered under the name of PT SGPS;
- The Company has tangible fixed assets located overseas with a net book value of Euro 11,867,428, including primarily participation in submarine cable consortiums;
- The tangible fixed assets which, under the terms of article 5 of the Annex to Decree-Law no. 31/2003 of February 17 which constituted the Bases for the Concession of Public Telecommunications Service (Note 1), are subject to the Concession, had a carrying value of Euro 1,709,598,507.

PT Comunicações
Notes to Financial Statements (Continued)
As at 31 December 2013
(Amounts in Euro)

7. Investment properties

During the years ended 31 December 2013 and 2012, movements occurred in this caption were as follows:

	2013	2012
	Euro	
Gross value		
Opening balance	16,792,420	17,791,958
Additions	4,432,233	—
Transfers, adjustments and other	—	(999,538)
Closing balance	21,224,653	16,792,420
Accumulated amortisation and impairment losses		
Opening balance	7,928,583	5,399,654
Amortisation (Nota 34)	1,120,137	482,639
Transfers, adjustments and other	(811,118)	2,046,290
Closing balance	8,237,602	7,928,583
Net value	12,987,051	8,863,837

Land and buildings that were not used in operating activities as at 31 December 2013 and 2012 were classified under this caption, according to the accounting policy adopted by the Company.

These assets are stated at acquisition cost less accumulated depreciation and impairment losses, if any. PT Comunicações makes periodic valuations of these assets. As at 31 December 2013, the real estate book value with acquisition cost exceeding Euro 50,000 amounted to approximately Euro 12.8 million, whereas the corresponding market value amounted to Euro 14.3 million.

During the years ended 31 December 2013 and 2012, PT Comunicações has obtained rental income from this real estate amounting to Euro 620,062 and Euro 638,953, respectively, which were classified under the caption "Other income and gains" (Note 32).

8. Goodwill

The composition of goodwill as at 31 December 2013, computed following the acquisition of subsidiaries, some of which were subsequently merged into the Company, is as follows:

<u>Entity</u>	<u>Year of acquisition</u>	<u>Carrying value</u>
		Euro
Mobile Business (Meo, SA)	2010	2,145,416,586
Wireline Business		
Internet Business / portal (ex- PT.Com)	2007	560,447,103
Corporate Business (ex- PT Prime)	2007	235,323,593
International Business (ex- Marconi)	2000	41,255,121
		2,982,442,403

For the purposes of impairment tests, goodwill was allocated to cash generating units. The recoverable amount was determined from the respective value in use through the discounted cash flows methodology, using a cash flow forecast of a four year period, which was prepared internally. The discount rate applied to projected cash flows, which was determined taking into account the risk

PT Comunicações
Notes to Financial Statements (Continued)
As at 31 December 2013
(Amounts in Euro)

8. Goodwill (Continued)

associated with each business, and the growth rates used to extrapolate cash flow projections beyond the period covered by the forecasts prepared internally were as follows:

<u>Assumptions</u>	<u>Internet Business</u>	<u>Corporate Business</u>
Growth rate	1.0% - 1.5%	1.0% - 1.5%
Discount rate	7.7% - 8.7%	7.7% - 8.7%

The recoverable amount of each cash generating unit was determined for the minimum and maximum values listed in the table above and the Company's management concluded that, as at 31 December 2013, the book value of the cash generating unit, including goodwill, did not exceed its recoverable amount.

9. Intangible assets

During the years ended 31 December 2013 and 2012, movements occurred in intangible assets were as follows:

	2013			Total
	Industrial property and other rights	Other intangible assets	Intangible assets in progress	
	Euro			
Gross value				
Opening balance	503,370,847	708,092	1,049,571	505,128,510
Acquisitions	4,004,860	249,498	3,589,224	7,843,582
Disposals	(9,379)	—	—	(9,379)
Transfers and write- offs	1,046,067	516,482	(819,337)	743,212
Closing balance	<u>508,412,395</u>	<u>1,474,072</u>	<u>3,819,458</u>	<u>513,705,925</u>
Accumulated amortisation and impairment losses				
Opening balance	269,518,825	337,007	—	269,855,832
Amortisation (Nota 34)	30,796,864	408,123	—	31,204,987
Disposals	(1,042)	—	—	(1,042)
Transfers and write- offs	(143,230)	—	—	(143,230)
Closing balance	<u>300,171,417</u>	<u>745,130</u>	<u>—</u>	<u>300,916,547</u>
Intangible assets, net	<u>208,240,978</u>	<u>728,942</u>	<u>3,819,458</u>	<u>212,789,378</u>

PT Comunicações
Notes to Financial Statements (Continued)
As at 31 December 2013
(Amounts in Euro)

9. Intangible assets (Continued)

	2012			Total
	Industrial property and other rights	Other intangible assets	Intangible assets in progress	
	Euro			
Gross value				
Opening balance	497,805,369	487,590	1,694,348	499,987,307
Acquisitions	5,553,990	220,502	1,049,571	6,824,063
Transfers and write-offs	11,488	—	(1,694,348)	(1,682,860)
Closing balance	503,370,847	708,092	1,049,571	505,128,510
Accumulated amortisation and impairment losses				
Opening balance	240,002,357	168,352	—	240,170,709
Amortisation (Nota 34)	30,161,753	168,655	—	30,330,408
Transfers and write-offs	(645,285)	—	—	(645,285)
Closing balance	269,518,825	337,007	—	269,855,832
Intangible assets, net	233,852,022	371,085	1,049,571	235,272,678

In 2013 and 2012, additions under the caption “Industrial property and other rights” relate primarily to the acquisition of software licenses regarding projects to develop new applications and features in the commercial, financials and logistic areas.

As at 31 December 2013, the net book value of the caption “Industrial property and other rights” includes mainly:

- An amount of Euro 170 million related to the acquisition of full ownership of the Basic Network by PT Comunicações to the Portuguese State, concluded in December 2002, which corresponds to the gross value capitalized in 2002 amounting Euro 339.9 million net of accumulated depreciation;
- An amount of Euro 9.2 million related to a contract entered into by PT Comunicações in 2007 and 2009 for the acquisition of satellite capacity rights until 2015, which was recorded as a financial lease; and
- An amount of Euro 22.4 million, corresponding to the TDT licenses recorded in 2011 (Note 1 (a)).

In 2013 and 2012, the Company performed innovation, research and development activities under which the following expenses and fixed assets were recorded:

	2013	2012
	Euro	
Tangible fixed assets	60,176,061	72,940,479
Intangible assets	563,532	1,424,785
Other operation expenses	14,565,478	10,796,763
Total	75,305,071	85,162,027

PT Comunicações
Notes to Financial Statements (Continued)
As at 31 December 2013
(Amounts in Euro)

10. Financial investments-equity method of accounting

During the years ended 31 December 2013 and 2012, the movements occurred under this caption were as follows:

	2013				Total
	Investments in subsidiary companies (Note 12)	Additional paid in capital contributions to subsidiary	Investments in associated companies (Note 12)	Loans in associated companies	
	Euro				
Gross value					
Opening balance	7,256,393,289	—	774,495	—	7,257,167,784
Increases	25,000	150,000	1,995,202	3,117,210	5,287,412
Reductions	(9,390)	—	—	—	(9,390)
Equity method	(339,829,923)	—	57,449	—	(339,772,474)
Other	—	—	997,596	—	997,596
Closing balance	6,916,578,976	150,000	3,824,742	3,117,210	6,923,670,928
Impairment losses					
Opening balance	—	—	—	—	—
Increases	—	—	1,995,192	—	1,995,192
Other	—	—	997,596	—	997,596
Closing balance	—	—	2,992,788	—	2,992,788
Financial investments, net	6,916,578,976	150,000	831,954	3,117,210	6,920,678,140

	2012			Total
	Investments in subsidiary companies (Note 12)	Investments in associated companies (Note 12)	Advances for financial investments ^(a)	
	Euro			
Gross value				
Opening balance	7,675,544,256	5,794,961	6,771,730	7,688,110,947
Reti merger ^(a)	(71,699)	—	—	(71,699)
Increases	50,000	—	1,094,382	1,144,382
Equity method	(183,670,364)	2,867,410	—	(180,802,954)
Dividends	(235,530,603)	(2,817,994)	—	(238,348,597)
Non current assets held for sale ^(b)	—	(5,069,882)	—	(5,069,882)
Other movements ^(b)	71,699	—	(7,866,112)	(7,794,413)
Closing balance	7,256,393,289	774,495	—	7,257,167,784
Impairment losses				
Opening balance	—	—	6,771,730	6,771,730
Increases	—	—	1,094,382	1,094,382
Other	—	—	(7,866,112)	(7,866,112)
Closing balance	—	—	—	—
Financial investments, net	7,256,393,289	774,495	—	7,257,167,784

(a) On 3 May 2012, PT Comunicações concluded the acquisition of an investment in RETI that was previously held by TVI, through the payment of the fifth and last installment, amounting to Euro 1,094,382 (Note 4), that was considered in an agreement entered in December 2009, and following the amounts already paid in previous years as advances for financial investments, for the total amount of Euro 6,771,730. These amounts were fully adjusted based on the Company's expectation that RETI's analogical network was redundant considering the network of PT Comunicações. As a result of the acquisition of this investment, the Company recorded an investment of Euro 71,699, corresponding to the shareholders' equity of the acquired company, and recorded a goodwill of Euro 7,794,413, corresponding to the difference between the acquisition price of Euro 7,866,112 and the financial investment. Both the goodwill and the impairment losses recognized in

PT Comunicações
Notes to Financial Statements (Continued)
As at 31 December 2013
(Amounts in Euro)

10. Financial investments-equity method of accounting (Continued)

previous years over payments made or to be made under the agreement entered into in December 2009, amounting to Euro 7,866,112, were transferred to net income. In December 2012, the Board of Directors of both companies approved the merger of RETI into PT Comunicações as from 3 May 2012 and, as such, the Company eliminated the financial investment in RETI, amounting to Euro 71,699, and recorded in its balance sheet the assets and liabilities of RETI as of that date that were transferred to PT Comunicações.

- (b) In the year ended 31 December 2012, the Company's investment in CTM amounting to Euro 5,069,882 (Note 20 a)), representing 3% of the capital of that company, was classified as a non-current asset held for sale. The disposal of this investment was completed in June 2013.

In 2013 and 2012, increases the gross value of financial investments accounted for by the equity method gross were as follows:

	2013	2012
	Euro	
Aquisition of Yunit—loans granted	2,228,328	—
Aquisition of INESC (Note 1) (b)		
Share capital	1,995,192	—
Additional paid in capital contributions	888,882	—
Constitution of Auto Sapo (Notes 1 and 4 (e))		
Share capital	25,000	—
Additional paid in capital contributions	150,000	—
Aquisition of Multicert (Notes 1 and 4 (e))	10	—
Advances for the aquisition of financial investments (Note 4 (e))	—	1,094,382
Acquisition of PT Blueclip (Note 4 (e))	—	50,000
	5,287,412	1,144,382

During the year ended 31 December 2013, the reduction amounting to Euro 9,390 in gross value of investments in subsidiary companies relates sale of the investment in PT Brasil, in the amount of Euro 8,869 (Notes 1 (b) and 4 (b)), has been recorded an accounting loss on disposal in the amount of Euro 521 (Note 27).

In 2013 and 2012, the movements occurred in investments in subsidiaries and associated companies resulting from the application of the equity method of accounting were recorded as follows:

	2013	2012
	Euro	
Gains in affiliated companies net (Note 27)	201,666,539	120,535,593
Adjustments to financial assets (Note 21.5)	(541,439,013)	(301,338,547)
	(339,772,474)	(180,802,954)

During the year ended 31 December 2013 were not paid dividends by subsidiaries and associated companies, accounted for by equity method. The detail of dividends attributed by subsidiaries and associated companies in 2012 is as follows (Note 4):

	2012
	Euro
Meo, SA	235,479,275
CTM	2,700,796
Multicert	117,19 8
Infonet	51,328
	238,348,597

PT Comunicações
Notes to Financial Statements (Continued)
As at 31 December 2013
(Amounts in Euro)

11. Post-retirement benefits

As referred to in Note 3, PT Comunicações is responsible for the payment of post-retirement benefits under defined benefit plans, which include pensions and pension supplements to retired and active employees, healthcare services after retirement age and salaries to suspended and pre-retired employees.

The actuarial valuations of Portugal Telecom's defined benefit plans as at 31 December 2013, 2012 and 2011 were computed based on the projected unit credit method and considered the following main financial and demographic actuarial assumptions:

	2013	2012	2011
	Euro		
Financial assumptions			
Discount rate for obligations related to:			
Pension supplements	3.00%	3.00%	4.75%
Salaries to suspended and pre-retired employees	2.00%	2.00%	3.75%
Healthcare	4.00%	4.00%	4.75%
Salary growth rate for obligations related to:			
Pension supplements and healthcare	1.75%	1.75%	1.75%
Salaries to suspended and pre-retired employees ⁽ⁱ⁾	0.00% - 1.75%	0.00% - 1.75%	0.00% - 1.75%
Pension growth rate	GDP linked	GDP linked	GDP linked
Social Security sustainability factor	Applicable	Applicable	Not applicable
Inflation rate	2.00%	2.00%	2.00%
Healthcare cost trend growth rate	3.00%	3.00%	3.00%

(i) For salaries payable until 2017, the salary growth rate ranges from 0% to 1% depending on the amount of the salary. As from 2018, the salary growth rate is 1.75% for all situations.

	2013	2012	2011
	Euro		
Demographic assumptions			
Mortality tables for active beneficiaries:			
Males	PA (90)m adjusted	PA (90)m adjusted	AM (92)
Females	PA (90)f adjusted	PA (90)f adjusted	AF (92)
Mortality tables for non-active beneficiaries:			
Males	PA (90)m adjusted	PA (90)m adjusted	PA (90)m adjusted
Females	PA (90)f adjusted	PA (90)f adjusted	PA (90)f adjusted
Retirement age ⁽ⁱ⁾	65 - 66	65	65
Disability table (Swiss Reinsurance Company)	25%	25%	25%
Active employees with spouses under the plan	35%	35%	35%
Turnover of employees	Nil	Nil	Nil

(i) In 2013, the Portuguese retirement age changed from 65 to 66 years old, applicable for the majority of Portugal Telecom's beneficiaries under post retirement benefit plans, although the retirement at 65 years old is still applicable for certain other employees.

The discount rate was computed based on long-term yield rates of high-rating bonds as of the date of the Balance sheet for durations comparable to the liabilities for pensions and pension supplements, salaries and health care benefits (between 4 and 15 years).

PT Comunicações
Notes to Financial Statements (Continued)
As at 31 December 2013
(Amounts in Euro)

11. Post-retirement benefits (Continued)

After the adoption of the amendment of IAS 19, the rate of return on long-term fund assets is the same as the discount rate used.

Salary growth rate was established in accordance with Group policy for wages and salaries and pension growth rates and the sustainability factor was established in line with Portuguese Government information.

Demographic assumptions considered by Portugal Telecom are based on mortality tables generally accepted for actuarial valuation purposes, with these tables being periodically adjusted to reflect the actual mortality rates observed among the plan participants.

In 2013 and 2012, the total impact of changes in actuarial assumptions a net losses of Euro 100,906,000, and Euro 136,212,106 (Notes 11.7), respectively, and was recognized directly in shareholders' equity.

The impact of an increase by 25 bp on the average discount rate actuarial assumption would be a decrease of the responsibilities for post retirement benefits by approximately Euro 23 million as at 31 December 2013, while the impact of an increase (decrease) in the health care cost trend rate by 1% would be an increase (decrease) of the responsibilities for post retirement benefits by approximately Euro 69 million (Euro 56 million) as at 31 December 2013.

The impact of an increase (decrease) by 1% in the discount rate actuarial assumption would be a increase (decrease) of post retirement benefit costs in the year 2013 by approximately Euro 8 million, corresponding to the increase (decrease) in net interest cost.

11.1. Supplement benefits

As referred to in Note 3, prior to the transfer of pension obligations to the Portuguese State, PT Comunicações was responsible for the payment of regulatory pensions and pension supplements to retired and active employees, and is no longer responsible for the payment of regulatory pensions following that transfer. These liabilities, which were estimated based on actuarial valuations, are as follows:

- a) Retirees and employees of Companhia Portuguesa Rádio Marconi, SA ("Marconi", a company merged into PT Comunicações in 2002) hired prior to 1 February 1998 are entitled to a supplemental pension benefit ("Marconi Complementary Fund"). In addition, PT Comunicações contributes to the fund "Fundo de Melhoria Marconi" with 1.55% of the salaries paid to these employees, which is responsible to pay the additional pension supplement.
- b) Retirees and employees of TLP and TDP hired prior to 23 June 1994 are entitled to receive a pension supplement from PT Comunicações, which complements the pension paid by the Portuguese social security system.
- c) On retirement, PT Comunicações pays a lump sum gratuity of a fixed amount which depends on the length of service completed by the employee.

Employees hired by PT Comunicações or any of its predecessor companies after the dates indicated above are not entitled to these benefits, as they are covered by the general Portuguese Government social security system.

As at 31 December 2013 and 2012, plans from PT Comunicações covered 19,763 and 19,814 beneficiaries, respectively, of which approximately 64% and 63%, are non active, respectively.

PT Comunicações
Notes to Financial Statements (Continued)
As at 31 December 2013
(Amounts in Euro)

11. Post-retirement benefits (Continued)

Based on the actuarial reports, the pension benefit obligation and the fair value of the pension funds as at 31 December 2013 and 2012 were as follows:

	2013	2012
	Euro	
Projected benefit obligations related to pension, pension supplements and gratuities	116,358,866	126,751,790
Pension funds assets at fair value	(94,660,571)	(99,529,441)
Net liabilities recognized (Note 11.4)	<u>21,698,295</u>	<u>27,222,349</u>

During the years ended 31 December 2013 and 2012, the movement in the projected benefit obligations was as follows:

	2013	2012
	Euro	
Opening balance of the projected benefit obligation	126,751,790	121,168,176
Payments of benefits and contributions		
Benefits paid by the Company (Note 11.5)	(785,525)	(983,643)
Benefits paid by the funds	(9,008,399)	(9,392,359)
Pension costs		
Service cost	562,000	442,893
Interest cost	3,467,000	5,345,763
Prior year service gain	(2,168,000)	—
Work force reduction programme costs	498,000	87,682
Net actuarial losses	(2,958,000)	9,878,905
Transfers between plans (Note 11.3)	—	204,373
Closing balance of the projected benefit obligation	<u>116,358,866</u>	<u>126,751,790</u>

During the years ended 31 December 2013 and 2012, the movement in the projected benefit obligations was as follows:

	2013		2012	
	Amount	%	Amount	%
	Euro			
Equities ⁽ⁱ⁾	19,300,270	20.4%	19,922,371	20.0%
Bonds ⁽ⁱ⁾	57,294,887	60.5%	60,201,161	60.5%
Property	2,314,224	2.4%	2,545,908	2.6%
Cash, treasury bills, short- term stocks and other assets ⁽ⁱⁱ⁾	15,751,190	16.6%	16,860,001	16.9%
	<u>94,660,571</u>	<u>100.0%</u>	<u>99,529,441</u>	<u>100.0%</u>

(i) The fair value of equity investments and bonds is quoted on active markets.

(ii) This caption includes term deposits amounting to Euro 5 million and 6 million as at 31 December 2013 and 2012, respectively.

Portugal Telecom is exposed to risks related to the changes in the fair value of the plan assets associated with Portugal Telecom's post-retirement defined pension supplement plans. The main purpose of the established investment policy is capital preservation through five main principles: (1) diversification; (2) stable strategic asset allocation and disciplined rebalancing; (3) lower exposure to currency fluctuations; (4) specialized instruments for each class of assets; and (5) cost control.

PT Comunicações
Notes to Financial Statements (Continued)
As at 31 December 2013
(Amounts in Euro)

11. Post-retirement benefits (Continued)

During the years ended 31 December 2013 and 2012, the movement in the plan assets was as follows:

	2013	2012
	Euro	
Opening balance of the plan assets	99,529,441	98,480,548
Actual return on assets	3,660,130	9,341,252
Payments of benefits	(9,008,399)	(9,392,359)
Contributions made by the Company (Note 11.5)	479,399	1,100,000
Closing balance of the plan assets	<u>94,660,571</u>	<u>99,529,441</u>

A summary of the components of the pension net cost recorded in the years ended 31 December 2013 and 2012 is presented below:

	2013	2012
	Euro	
Service cost	562,000	442,893
Net interest cost	614,000	885,671
Prior years' service gains recognized in the period	(2,168,000)	—
Current pension cost (Notes 11.4 and 11.6)	<u>(992,000)</u>	<u>1,328,564</u>
Work force reduction program	498,000	87,682
Total cost of redundancy programme (Notes 11.4 and 11.6)	<u>498,000</u>	<u>87,682</u>
Total pension cost	<u>(494,000)</u>	<u>1,416,246</u>

Actuarial gains and losses, which result from changes in actuarial assumptions and from differences between those actuarial assumptions and actual data, are recognized directly in shareholders' equity. During the years ended 31 December 2013 and 2012, the movement in accumulated net actuarial losses was as follows:

	2013	2012
	Euro	
Opening balance	126,801,616	121,803,871
Change in actuarial assumptions (Note 11.7)	(1,044,000)	17,334,547
Differences between actual data and actuarial assumptions (Note 11.7)		
Pension benefit obligation related ^(a)	(1,914,000)	(7,455,642)
Asset related	(807,130)	(4,881,160)
Closing balance	<u>123,036,486</u>	<u>126,801,616</u>

(a) Differences between actual data and actuarial assumptions related to the PBO, results mainly from updated information regarding beneficiaries.

11.2. Health care benefits

As referred to in Note 3, PT Comunicações is responsible for the payment of post-retirement health care benefits to certain employees, suspended employees, pre-retired employees, retired employees and their eligible relatives. Health care services are rendered by PT-ACS, which was incorporated with the sole purpose of managing the Company's Health Care Plan.

This plan, sponsored by PT Comunicações, includes all employees hired by PT Comunicações until 31 December 2000 and by Marconi until 1 February 1998.

PT Comunicações
Notes to Financial Statements (Continued)
As at 31 December 2013
(Amounts in Euro)

11. Post-retirement benefits (Continued)

As at 31 December 2013 and 2012, healthcare plans from PT Comunicações covered 23,402 and 23,894 beneficiaries related to employees and former employees, of which approximately 77% and 76% were non-active, respectively. In addition, as at 31 December 2013 and 2012, these plans also covered 10,265 and 10,850 beneficiaries related to relatives of employees and former employees.

The financing of the Health Care Plan is assured by defined contributions made by participants to PT ACS and the remainder by PT Comunicações, which incorporated a fund in 2004 that is managed independently for this purpose.

Based on the actuarial reports, the defined benefit obligations and the fair value of the health care plan assets as at 31 December 2013 and 2012 are as follows:

	2013	2012
	Euro	
Projected benefit obligations	375,657,623	374,474,961
Plan assets at fair value	(291,667,072)	(299,865,329)
Present value of unfunded obligations (Note 11.4)	83,990,551	74,609,632

During the years ended 31 December 2013 and 2012, the movement in the projected benefit obligations was as follows:

	2013	2012
	Euro	
Opening balance of the projected benefit obligations	374,474,961	351,843,072
Benefits paid by the Company (Note 11.5)	(18,817,338)	(18,977,302)
Health care cost		
Service cost	3,565,000	2,988,477
Interest cost	14,671,000	16,326,001
Work force reduction costs	1,324,000	(163,036)
Net actuarial losses	440,000	22,457,749
Closing balance of the projected benefit obligations	375,657,623	374,474,961

As at 31 December 2013 and 2012, the portfolio of the Company's autonomous fund to cover post-retirement health care benefit obligations was as follows:

	2013		2012	
	Amount	%	Amount	%
	Euro			
Equities ^(a)	87,389,300	30.0%	75,277,597	25.1%
Bonds ^(b)	57,595,149	19.7%	88,178,641	29.4%
Cash, treasury bills, short-term stocks and other assets ^(c)	146,682,623	50.3%	136,409,091	45.5%
	291,667,072	100.0%	299,865,329	100.0%

(a) As at 31 December 2013 and 2012, this caption corresponds to investments in shares of Banco Espírito Santo, which is quoted on an active market.

(b) As at 31 December 2013 and 2012, this caption includes mainly investments in bonds of Portugal Telecom, which is quoted on an active market.

(c) As at 31 December 2013 and 2012, this caption includes investments in the private equity funds "Ongoing International Capital Markets" and "Ongoing International Private Equity" totalling Euro 95 million and Euro 104 million, respectively, which are managed by Global investment Opportunities SICAV. In addition, this caption also includes term deposits

PT Comunicações
Notes to Financial Statements (Continued)
As at 31 December 2013
(Amounts in Euro)

11. Post-retirement benefits (Continued)

amounting to Euro 14 million and Euro 11 million as at 31 December 2013 and 2012, respectively, and receivables from customers of PT Group companies totalling Euro 15 million as at 31 December 2013, following an agreement entered into with those companies for the transfer of those receivables to the fund assets.

During 2013 and 2012, the movement in the plan assets was as follows:

	2013	2012
	Euro	
Opening balance of the plan assets	299,865,329	246,214,842
Actual return on assets	13,840,743	74,473,916
Refunds (Note 11.5) ^(a)	(22,039,000)	(20,823,429)
Closing balance of the plan assets	291,667,072	299,865,329

(a) This caption relates to refunds of expenses paid by PT Comunicações on behalf of PT ACS.

A summary of the components of the net periodic post-retirement health care cost in 2013 and 2012 is presented below:

	2013	2012
	Euro	
Service cost	3,565,000	2,988,477
Net interest cost	2,676,000	5,017,341
Current cost (Notes 11.4 and 11.6)	6,241,000	8,005,818
Work force reduction program costs	1,324,000	(163,036)
Total cost of redundancy programme (Notes 11.4 and 11.6)	1,324,000	(163,036)
Health care cost	7,565,000	7,842,782

Actuarial gains and losses, which result from changes in actuarial assumptions and from differences between those actuarial assumptions and actual data, are recognized directly in shareholder's equity. During the years ended 31 December 2013 and 2012, the movement in accumulated net actuarial losses was as follows:

	2013	2012
	Euro	
Opening balance	277,244,343	317,951,850
Change in actuarial assumptions (Note 11.7)	(1,073,000)	37,439,494
Differences between actual data and actuarial assumptions (Note 11.7):		
Health care benefit obligation related	1,513,000	(14,981,745)
Assets related	(1,845,743)	(63,165,256)
Closing balance	275,838,600	277,244,343

11.3. Pre-retired and suspended employees

As mentioned in Note 3, PT Comunicações is also responsible for the payment of salaries to suspended and pre-retired employees until they reach the Portuguese social security retirement age. As at 31 December 2013 and 2012, there were 5,304 and 5,441 suspended and pre-retired employees, respectively.

PT Comunicações
Notes to Financial Statements (Continued)
As at 31 December 2013
(Amounts in Euro)

11. Post-retirement benefits (Continued)

These liabilities are not subject to any legal funding requirement, therefore the monthly payment of salaries is made directly by PT Comunicações.

During the years ended 31 December 2013 and 2012, the movement in the projected benefit obligation was as follows:

	2013	2012
	Euro	
Opening balance of the projected benefit obligation	727,258,078	779,921,779
Benefits paid by the Company (Notes 11.4 and 11.5)	(156,387,158)	(159,183,194)
Interest cost (Notes 11.4 e 11.6)	13,222,000	25,657,325
Work force reduction costs (Notas 11.4 e 11.6)	108,227,000	(246,969)
Net actuarial losses (Notes 11.4 and 11.7)	143,956,873	81,313,510
Transfers between plans (Note 11.1)	—	(204,373)
Closing balance of the projected benefit obligation (Note 11.4) .	<u>836,276,793</u>	<u>727,258,078</u>

Actuarial gains and losses, which result from changes in actuarial assumptions and from differences between those actuarial assumptions and actual data, are recognized directly in shareholders' equity. During the years ended 31 December 2013 and 2012, the movement in accumulated net actuarial losses was as follows:

	2013	2012
	Euro	
Opening balance	164,466,120	83,152,610
Change in actuarial assumptions (Note 11.7)	103,023,000	81,438,065
Differences between actual data and actuarial assumptions (Note 11.7)	40,933,873	(124,555)
Closing balance	<u>308,422,993</u>	<u>164,466,120</u>

PT Comunicações
Notes to Financial Statements (Continued)
As at 31 December 2013
(Amounts in Euro)

11. Post-retirement benefits (Continued)

11.4. Responsibilities for post-retirement benefits

The movements observed in post-retirement benefit obligations, net of the related asset funds, during the years ended 31 December 2013 and 2012 were as follows:

	Pension benefits (Note 11.1)	Health care benefits (Note 11.2)	Salaries to pre-retired and suspended employees (Note 11.3)	Total
	Euro			
Balance as at 31 December 2011 . . .	22,687,628	105,628,230	779,921,779	908,237,637
Transfers between plans	204,373	—	(204,373)	—
Net periodic pension cost/(gain) (Note 11.6)	1,328,564	8,005,818	25,657,325	34,991,707
Work force reduction costs (Note 11.6)	87,682	(163,036)	(246,969)	(322,323)
Payments, contributions and refunds (Note 11.5)	(2,083,643)	1,846,127	(159,183,194)	(159,420,710)
Net actuarial losses (gains) (Notes 11.7 and 11.8)	4,997,745	(40,707,507)	81,313,510	45,603,748
Balance as at 31 December 2012 . . .	27,222,349	74,609,632	727,258,078	829,090,059
Net periodic pension cost/(gain) (Note 11.6)	(992,000)	6,241,000	13,222,000	18,471,000
Work force reduction costs (Note 11.6)	498,000	1,324,000	108,227,000	110,049,000
Payments, contributions and refunds (Note 11.5)	(1,264,924)	3,221,662	(156,387,158)	(154,430,420)
Net actuarial losses/(gains) (Notes 11.7 and 11.8)	(3,765,130)	(1,405,743)	143,956,873	138,786,000
Balance as at 31 December 2013 . . .	21,698,295	83,990,551	836,276,793	941,965,639

Certain post-retirement benefit plans have a surplus position and therefore were presented in the Balance sheet separately from those plans with a deficit position. As at 31 December 2013 and 2012, net post-retirement obligations were recognized in the Balance sheet as follows:

	2013	2012
	Euro	
Plans with a deficit position:		
Pensions	23,532,295	28,855,189
Healthcare	83,990,551	74,609,632
Salaries to pre- retired and suspended employees	836,276,793	727,258,078
	943,799,639	830,722,899
Plans with a surplus position:		
Pensions	(1,834,000)	(1,632,840)
	(1,834,000)	(1,632,840)
	941,965,639	829,090,059

PT Comunicações
Notes to Financial Statements (Continued)
As at 31 December 2013
(Amounts in Euro)

11. Post-retirement benefits (Continued)

11.5. Cash flows relating to post-retirement benefit plans

During the years ended 31 December 2013 and 2012, the payments and contributions regarding post-retirement benefits were as follows:

	2013	2012
	Euro	
Pensions		
Contributions to the funds (Note 11.1)	479,399	1,100,000
Payments of pension supplements (Note 11.1)	785,525	983,643
Sub total (Note 11.4)	1,264,924	2,083,643
Health care		
Refunds (Note 11.2)	(22,039,000)	(20,823,429)
Payments of health care expenses (Note 11.2)	18,817,338	18,977,302
Sub total (Note 11.4)	(3,221,662)	(1,846,127)
Other payments		
Payments of salaries to pre- retired and suspended employees (Notes 11.3 and 11.4)	156,387,158	159,183,194
Termination payments (Note 11.6)	2,751,916	1,482,772
Service cost related to liabilities transferred to the Portuguese State ^(a)	21,751,776	25,482,982
Sub total	180,890,850	186,148,948
	178,934,112	186,386,464

(a) This caption corresponds to a fixed contribution paid by PT Comunicações to the Portuguese Social Security System relating to the annual service of active and suspended employees that were entitled to pension benefits under the Company's post-retirement benefit plans that were transferred to the Portuguese State in December 2010.

11.6. Post-retirement benefit costs

In 2013 and 2012, post-retirement benefit costs and curtailment and settlement costs were as follows:

	2013	2012
	Euro	
Post retirement benefits, net		
Pension supplements (Notes 11.1 and 11.4)	(992,000)	1,328,564
Health care benefits (Notes 11.2 and 11.4)	6,241,000	8,005,818
Salaries (Notes 11.3 and 11.4)	13,222,000	25,657,325
Service cost related to liabilities transferred to the Portuguese state ^(a)	21,783,067	22,337,313
	40,254,067	57,329,020
Redundancy costs and liquidation		
Pension supplements (Notes 11.1 and 11.4)	498,000	87,682
Health care (Notes 11.2 and 11.4)	1,324,000	(163,036)
Salaries (Notes 11.3 and 11.4)	108,227,000	(246,969)
Termination payments (Note 11.5)	2,751,916	1,482,772
	112,800,916	1,160,449

(a) This caption corresponds to a fixed contribution paid by PT Comunicações to the Portuguese Social Security System relating to the annual service of active and suspended employees that were entitled to pension benefits under the Company's post-retirement benefit plans that were transferred to the Portuguese State in December 2010.

PT Comunicações
Notes to Financial Statements (Continued)
As at 31 December 2013
(Amounts in Euro)

11. Post-retirement benefits (Continued)

11.7. Net actuarial losses (gains)

In 2013 and 2012, the net actuarial gains and losses recorded in shareholders' equity were as follows:

	2013	2012
	Euro	
Changes in actuarial assumptions		
Pension benefits (Note 11.1)	(1,044,000)	17,334,547
Health care benefits (Note 11.2)	(1,073,000)	37,439,494
Salaries (Note 11.3)	103,023,000	81,438,065
Sub-total (Note 11)	100,906,000	136,212,106
Differences between actual data and actuarial assumptions		
Pension benefits (Note 11.1)	(2,721,130)	(12,336,802)
Health care benefits (Note 11.2)	(332,743)	(78,147,001)
Salaries (Note 11.3)	40,933,873	(124,555)
Sub-total	37,880,000	(90,608,358)
Total (Notes 11.4, 11.8 and 20.4)	138,786,000	45,603,748

Net actuarial losses and gains recorded in 2013 and 2012 related to changes in actuarial assumptions mainly resulting from the changes in the financial and demographic actuarial assumptions detailed above, as follows:

- Net actuarial losses recognized in 2013 amounting to Euro 101 million correspond to the impact of the change in the Portuguese retirement age from 65 to 66 years old;
- Net actuarial losses recorded in 2012, amounting to Euro 136 million, include primarily the impacts resulting from (1) the suspension of the early retirement regime (loss of Euro 39 million), either permanently for employees under the CGA regime or during the financial assistance programme to Portugal for the remaining employees, (2) the reduction in the discount rates for responsibilities with pension supplements, health care benefits and salaries payable to suspended and pre-retired employees (loss of Euro 102 million), and (3) the change in the mortality tables for active beneficiaries;

The detail of net actuarial gains and losses resulting from differences between actual data and actuarial assumptions is as follows:

- Net actuarial losses recognized in 2013 amounting to Euro 38 million include (1) a gain of Euro 3 million related to the difference between actual return on plan assets (+4.5%) and expected return on plan assets calculated based on discount rates used to compute PBO, and (2) a loss of Euro 41 million related to the difference between actual data and actuarial assumptions related to projected benefits obligations, namely those assumptions related to the salary, pension and healthcare cost trend growth rates;
- Actuarial gains recognized in 2012, amounting to Euro 91 million, include (i) a gain of Euro 68 million related to the difference between actual (+25.2%) and expected return on plan assets calculated based on discount rates used to compute PBO, and (ii) a gain of Euro 23 million corresponding to the difference between actual data and actuarial assumptions regarding projected responsibilities, particular assumptions about growth rates of wages, pensions and health care;

PT Comunicações
Notes to Financial Statements (Continued)
As at 31 December 2013
(Amounts in Euro)

11. Post-retirement benefits (Continued)

11.8. Other disclosures

The table below presents historical data for a five year period about the present value of projected benefit obligations, the fair value of the plan assets, the surplus or deficit in the plans and the net actuarial gains and losses. The detail of this data for all the plans mentioned above as at 31 December 2013, 2012, 2011, 2010 and 2009 and for the years then ended is as follows:

	<u>2013</u>	<u>2012</u>	<u>2011</u>	<u>2010</u>	<u>2009</u>
	Euro				
Projected benefit obligations ^(a)	1,328,293,282	1,228,484,830	1,252,933,027	1,393,777,823	3,836,029,063
Plan assets at fair value ^(a)	<u>(386,327,643)</u>	<u>(399,394,770)</u>	<u>(344,695,390)</u>	<u>(448,145,688)</u>	<u>(2,369,524,484)</u>
Net unfunded obligations	<u>941,965,639</u>	<u>829,090,060</u>	<u>908,237,637</u>	<u>945,632,135</u>	<u>1,466,504,579</u>
	<u>2013</u>	<u>2012</u>	<u>2011</u>	<u>2010</u>	<u>2009</u>
Changes in actuarial assumptions	100,906,000	136,212,106	(19,337,022)	441,557,656	(1,594,152)
Differences between actual data and actuarial assumptions					
Projected benefit obligations related	40,532,873	(22,561,941)	(7,065,466)	(67,501,464)	15,827,000
Plan assets related	<u>(2,652,873)</u>	<u>(68,046,417)</u>	<u>92,782,990</u>	<u>72,411,885</u>	<u>(184,120,001)</u>
Total net actuarial losses (gains) (Notes 11.4 and 11.7)	<u>138,786,000</u>	<u>45,603,748</u>	<u>66,380,502</u>	<u>446,468,077</u>	<u>(169,887,153)</u>

(a) The decrease in this caption in the year ended 31 December 2010, is mainly related to the Company's post-retirement benefit plans that were transferred to the Portuguese State.

As at 31 December 2013, the estimate of future undiscounted payments to be made by PT Comunicações related to salaries due to pre-retired and suspended employees and to expected contributions to the funds is as follows:

	<u>Million Euro</u>
2014	155.2
2015 - 2016	268.5
2017 - 2018	216.6
More than 5 years	<u>394.5</u>
Total	<u>1,034.8</u>

PT Comunicações
Notes to Financial Statements (Continued)
As at 31 December 2013
(Amounts in Euro)

12. Related parties

12.1. Balances with shareholders and group companies

As at 31 December 2013 and 2012, the captions “Shareholders and group companies” included in non-current assets and in current liabilities have the following composition:

	2013	2012
	Euro	
DEBIT BALANCES		
Non- Current		
Loans granted ^(a)	—	340,000,000
Total debit balances with shareholders and group companies	—	340,000,000
CREDIT BALANCES		
Current		
Accounts payable from PT SGPS within tax consolidation ^(b)	196,243	1,607,803
Other	3,006,565	49,440
Total credit balances with shareholders and group companies	3,202,808	1,657,243

(a) Loans granted to MEO, SA in November 2010, in connection with the acquisition of this company, for an amount of Euro 500,000,000, were repaid in 2011 and 2013 for the amounts of Euro 160,000,000 and Euro 340,000,000, respectively (Note 4 (c)).

(b) During the years ended as at 31 December 2013 and 2012, PT Comunicações reported tax losses that were used by PT SGPS consolidated tax, rather than being recognized as a gain in the Company’s financial statements. The accounts payable at 31 December 2013 and 2012 correspond mainly to autonomous taxation.

12.2. Financial investments in subsidiaries and associated companies

As mentioned in the Introduction Note, Portugal Telecom is 100% held by PT Portugal which is fully held by PT SGPS. Consequently, all companies included in the Group were considered as PT Comunicações related parties, including not only its own subsidiaries and associates but also other subsidiaries of PT SGPS.

PT Comunicações
Notes to Financial Statements (Continued)
As at 31 December 2013
(Amounts in Euro)

12. Related parties (Continued)

As at 31 December 2013 and 2012, the detail of Portugal Telecom's financial investments in its subsidiaries and associated companies and the main financial information of these entities is detailed as follows (Notes 10, 22 and 27):

Company name	2013				2012			
	% held	Financial investments	Provision for financial investments	Share on net income	% held	Financial investments	Provision for financial investments	Share on net income
				Euro				
SUBSIDIARIES:								
Meo, SA	100.00%	6,914,013,261	—	202,353,669	100.00%	7,253,097,184	—	117,781,680
Janela Digital ^(a)	50.00%	2,048,674	—	—	50.00%	2,048,674	—	(128,292)
Infonet	90.00%	411,530	—	(777,439)	90.00%	1,188,968	—	(111,958)
PT Blueclip ^(b)	100.00%	84,037	—	36,234	100.00%	47,803	—	(2,198)
Auto Sapo ^(c)	50.00%	21,474	—	(3,526)	—	—	—	—
PT Prestações	100.00%	—	(293,898)	2,444	100.00%	—	(296,342)	(4,286)
PT Brasil,S.A. ("PT Brasil") ^{(d)(e)}	0.01%	—	—	127	0.01%	10,660	—	106
PT-Sistemas de Informação ("PT-SI") ^(e)	0.10%	—	(2,779)	(2,447)	0.10%	—	(1,006)	(3,015)
		6,916,578,976	(296,677)	201,609,062		7,256,393,289	(297,348)	117,532,037
ASSOCIATED COMPANIES:								
Multicert, SA ("Multicert") ^(f)	20.00%	734,468	—	24,664	20.00%	709,793	—	161,282
Capital Criativo								
SCR, S.A. ("Capital Criativo")	10.00%	97,486	—	32,811	10.00%	64,702	—	3,320
Yunit ^(g)	33.33%	—	(103,583)	—	—	—	—	—
CTM ^(h)	—	—	—	—	3.00%	—	—	2,833,844
		831,954	(103,583)	57,475		774,495	—	2,998,446
		6,917,410,930	(400,260)	201,666,537		7,257,167,784	(297,348)	120,530,483

(a) The 2013 and 2012 information does not correspond to figures of 31 December.

(b) This company was acquired in 2012 to PT SGPS.

(c) This company was incorporated in July 2013 (Note 1 b)) and its shareholders' equity includes additional paid amounting to Euro 300,000, having PT Comunicações granted Euro 150,000.

(d) This company was sold in December 2013 to PT SGPS (Note 1 b)).

(e) Portugal Telecom Group has a 100% stake in these companies.

(f) In December 2013, PT Communications acquired 0.0004% of Multicert capital, a company owned by PT SGPS, so now holds a stake of 20% in the share capital of that company (Note 1 b)).

(g) This company was acquired in December 2013 to PT SGPS, as mentioned in the Note 1 b).

(h) As mentioned in Note 20, the stake in this company was classified as non-current asset held for sale at 31 December 2012, following an agreement for disposal of this investment. This operation was completed in June 2013.

PT Comunicações
Notes to Financial Statements (Continued)
As at 31 December 2013
(Amounts in Euro)

12. Related parties (Continued)

In 2013 and 2012, the main financial information regarding the above entities, except for those which have no activity or are fully adjusted for, is as follows:

Company name	Headquarters	2013				
		Assets	Liabilities	Services rendered and sales	Net (Loss) Income	Shareholders' equity
		Euro				
SUBSIDIARIES:						
Meo, SA ^(a)	Av. Álvaro Pais, 2 1649- 041 Lisboa	7,661,874,641	747,861,380	1,054,564,457	202,353,669	6,914,013,261
Janela Digital ^(b)	Parque Tecnológico de Óbidos Rua da Criatividade, Lote 6 2510-034 Óbidos	5,182,382	1,085,035	3,910,781	1,029,962	4,097,347
Infonet	Rua Castilho, 39, 12G 1250- 068 Lisboa	661,235	203,980	562,996	(863,821)	457,255
PT Blueclip	Av. Fontes Pereira de Melo, n.º 40 1050- 122 Lisboa	245,415	161,378	52,544	36,234	84,037
Auto Sapo ^(c)	Edifício Manheim—MARL Lugar do Quintanilha 2660 - 421 São Julião do Tojal	358,339	15,391	—	(7,052)	342,948
PT Prestações ^(d)	Rua Andrade Corvo, n.º 6 1050- 009 Lisboa	301,234,792	43,818,626	161,290	2,444	257,416,166
PT-SI ^(e)	Taguspark—Parque da Ciência e Tecnologia Av. Jacques Delors, Edifícios Inovação III e IV 2740-122 Porto Salvo	53,092,434	45,842,091	92,083,746	(2,446,656)	7,250,343
ASSOCIATED COMPANIES:						
Multicert ^(f)	Estrada do Casal do Canas, Lote 6 2610- 264 Alfragide	5,106,952	1,434,590	988,606	138,654	3,672,362
Capital Criativo ^(g)	Urbanização de Loures Business Park, EN 115, Lt. 5, 2660-515 Loures	1,503,681	528,822	476,020	195,617	974,859
Yunit ^(h)	Rua de Entrecampos, n.º 28, Lisboa	12,004,907	12,315,651	3,898,317	(367,284)	(310,744)

PT Comunicações
Notes to Financial Statements (Continued)
As at 31 December 2013
(Amounts in Euro)

12. Related parties (Continued)

Company name	Headquarters	2012		Services rendered and sales	Net (Loss) Income	Shareholders' equity
		Assets	Liabilities			
SUBSIDIARIES:						
Meo, SA ^(a)	Av. Álvaro Pais, 2 1649- 041 Lisboa	8,241,316,756	988,219,572	1,153,310,003	117,781,680	7,253,097,184
Janela Digital ^(b)	Parque Tecnológico de Óbidos Rua da Criatividade, Lote 6 2510-034 Óbidos	5,182,382	1,085,035	3,910,781	1,029,962	4,097,347
Infonet	Rua Castilho, 39, 12G 1250- 068 Lisboa	1,466,516	145,440	1,142,323	(124,398)	1,321,076
PT Blueclip	Av. Fontes Pereira de Melo, n.º 40 1050- 122 Lisboa	50,506	2,703	—	(2,198)	47,803
PT Prestações ^(d)	Rua Andrade Corvo, n.º 6 1050- 009 Lisboa	300,151,428	20,699,195	179,114	(4,286)	279,452,233
PT Brasil	Av. Brigadeiro Faria de Lima, n.º 2277, 15.º 1503 Jardim Paulistano S. Paulo—Brasil	236,382,533	25,282,479	—	2,099,615	211,100,054
PT-SI ^(e)	Taguspark—Parque da Ciência e Tecnologia Av. Jacques Delors, Edifícios Inovação III e IV 2740-122 Porto Salvo	69,907,667	60,884,381	110,995,705	(3,014,854)	9,023,286
ASSOCIATED COMPANIES:						
Multicert	Estrada do Casal do Canas, Lote 6 2610- 264 Alfragide	5,059,265	1,510,224	2,731,569	756,080	3,549,041
Capital Criativo ^(g)	Urbanização de Loures Business Park, EN 115, Lt. 5, 2660-515 Loures	664,658	17,649	190,282	33,199	647,009
CTM	Edifício Telecentro Ilha da Taipa Macau	268,583,983	99,587,914	456,240,787	94,428,628	168,996,069

(a) The Company's financial information was adjusted in order to reflect the impacts resulting from the purchase price allocation of this investment, which was concluded in 2011 and recognized retrospectively to the acquisition date, as mentioned above.

(b) The 2013 and 2012 information does not correspond to figures of 31 December.

(c) Information reported as of 31 August 2013. Shareholders' equity includes additional paid in capital amounting to Euro 300,000.

(d) As of 31 December 2013 and 2012, shareholders' equity includes additional paid in capital amounting to Euro 257,710,064 and Euro 279,748,575, respectively.

(e) As of 31 December 2013 and 2012, shareholders' equity includes additional paid in capital amounting to Euro 10,028,970.

(f) Information reported as of 30 April 2013.

(g) The 2013 and 2012 information correspond to figures of 30 November 2013 and 2012, respectively.

(h) Information reported as of 30 November 2013.

12.3. Balances and transactions with related parties

Besides the receivables and payables included under the captions "Shareholders and group companies", as detailed above (Note 12.1), the Company has other receivables and payables with

PT Comunicações
Notes to Financial Statements (Continued)
As at 31 December 2013
(Amounts in Euro)

12. Related parties (Continued)

related parties included in other captions. The nature and detail of the main balances with related parties as at 31 December 2013 and 2012 are as follows:

	2013		
	Accounts receivable and unbilled revenues	Other accounts receivable	Total accounts receivable
	Euro		
Meo, SA	48,906,478	71,239	48,977,717
UNITEL, SARL (“UNITEL”)	11,988,808	297,326	12,286,134
Fibroglobal	1,179,557	9,751,562	10,931,119
CST—Companhia Santomense Telecomunicações, SARL (“CST”)	5,551,450	—	5,551,450
PT PRO, Serviços Administrativos e de Gestão Partilhados, SA (“PT Pro”)	3,157,838	19,662	3,177,500
PT Centro Corporativo SA (“PT CC”)	3,003,764	7,554	3,011,318
PT SI	1,161,651	1,547,848	2,709,499
PT ACS	2,561,008	80,219	2,641,227
Timor Telecom	1,835,375	—	1,835,375
Portugal Telecom Inovação, SA (“PT Inovação”)	1,698,276	2	1,698,278
PT Contact—Telemarketing e Serviços de Informação, S.A. (“PT Contact”)	1,338,542	82,648	1,421,190
PT SGPS	135,686	383,441	519,127
Other	4,769,986	534,775	5,304,761
	87,288,419	12,776,276	100,064,695

	2012			
	Shareholders and group companies (Note 12.1)	Accounts receivable and unbilled revenues	Other accounts receivable	Total accounts receivable
	Euro			
Meo, SA	340,000,000	72,830,941	27,491,489	440,322,430
UNITEL	—	7,988,639	—	7,988,639
PT Pro	—	5,714,830	568	5,715,398
Páginas Amarelas	—	4,163,169	903,834	5,067,003
CST	—	4,966,063	—	4,966,063
PT Data Center	—	4,134,813	—	4,134,813
PT Contact	—	3,200,753	109	3,200,862
PT SI	—	786,919	1,882,137	2,669,056
Fibroglobal	—	1,966,391	603,272	2,569,663
PT CC	—	2,261,542	505	2,262,047
PT ACS	—	1,834,544	(37,364)	1,797,180
PT Inovação	—	1,710,012	2,165	1,712,177
Other	—	4,007,301	272,928	4,280,229
	340,000,000	115,565,917	31,119,643	486,685,560

PT Comunicações
Notes to Financial Statements (Continued)
As at 31 December 2013
(Amounts in Euro)

12. Related parties (Continued)

As at 31 December 2013 and 2012, the nature and detail of the main credit balances with related parties are as follows:

	2013				Total accounts payable
	Loans obtained (Note 23)	Shareholders and Group companies (Note 12.1)	Accounts payable and Accrued expenses	Other accounts payable	
	Euro				
PT Portugal	3,779,000,000	—	86,112,509	—	3,865,112,509
PT SGPS	342,322,714	3,179,972	5,855,598	92	351,358,376
Meo, SA	—	10,224	66,978,393	1,280,580	68,269,197
PT Sales	—	—	19,855,330	3,771	19,859,101
PT Pro	—	—	19,099,755	3,306	19,103,061
PT SI	—	12,612	14,442,829	119,601	14,575,042
PT CC	—	—	12,420,442	7,908	12,428,350
PT Inovação	—	—	8,856,969	94,190	8,951,159
PT ACS	—	—	4,650,084	2,183,936	6,834,020
PT Contact	—	—	5,476,056	77,108	5,553,164
Cabo Verde Telecom, SARL (“CVT”)	—	—	3,977,115	378	3,977,493
UNITEL	—	—	3,929,860	—	3,929,860
CST	—	—	2,235,865	—	2,235,865
Other	—	—	4,004,233	1,015,150	5,019,383
	<u>4,121,322,714</u>	<u>3,202,808</u>	<u>257,895,038</u>	<u>4,786,020</u>	<u>4,387,206,580</u>
	2012				
	Loans obtained (Note 23)	Shareholders and Group companies (Note 12.1)	Accounts payable and accrued expenses	Other accounts payable	Total accounts Payable
	Euro				
PT Portugal	3,527,000,000	—	61,422,333	—	3,588,422,333
PT SGPS	117,962,274	1,607,803	1,804,520	127	121,374,724
PT Contact	—	—	42,615,164	7,446	42,622,610
PTPRO	—	—	24,541,904	5,193	24,547,097
Meo, SA	—	41,582	15,554,866	2,930,466	18,526,914
PT SI	—	7,590	16,196,351	6,968	16,210,909
PT Sales	—	—	12,054,638	10,124	12,064,762
PT Inovação	—	—	11,472,188	9,464	11,481,652
PT CC	—	—	9,309,436	9,016	9,318,452
PT ACS	—	268	6,088,695	3,211,554	9,300,517
Páginas Amarelas	—	—	6,518,341	1,847	6,520,188
UNITEL	—	—	2,681,438	—	2,681,438
CST	—	—	1,884,940	—	1,884,940
Other	—	—	3,872,464	126,357	3,998,821
	<u>3,644,962,274</u>	<u>1,657,243</u>	<u>216,017,278</u>	<u>6,318,562</u>	<u>3,868,955,357</u>

PT Comunicações
Notes to Financial Statements (Continued)
As at 31 December 2013
(Amounts in Euro)

12. Related parties (Continued)

During the years ended 31 December 2013 and 2012, the nature and detail of the main transactions with related parties are as follows:

	2013						
	Sales and services rendered	Costs of services rendered	Supplies and external services	Wages and salaries ^(a)	Other operating income and gain	Other operating expenses and losses	Net interest expenses
	Euro						
Meo, SA	95,275,288	(105,789,247)	(6,420,531)	4,827,835	17,661,266	(111,494)	2,706,196
UNITEL	10,536,187	(5,272,401)	(5,039)	—	8,708	(48,357)	—
Páginas Amarelas	2,614,350	(20,672,485)	18,392	—	—	—	—
PT Contact	1,860,991	(2,504,097)	(65,373,897)	8,801,546	4,309,886	—	—
Timor Telecom	1,614,654	(1,172,713)	—	209,722	91,929	(82,071)	—
CST	1,407,967	(1,739,623)	—	—	1,212,084	(3,622)	—
Fibroglobal	1,330,517	(1,822,163)	—	317,969	259,963	(40,888)	298,644
MTC	1,281,330	(309,545)	—	—	32,977	(6,686)	—
PT ACS	1,250,355	—	(61,900)	(3,707,466)	31,396	—	—
CVT	855,974	(7,399,715)	13,846	—	7,499	(885)	—
Cabo Verde Multimédia, Sociedade Unipessoal, S.A. ("CV Multimédia")	690,761	(3,735)	—	—	—	—	—
Vortal	519,796	—	(6,000)	—	140	—	—
PT Inovação	337,289	(218,167)	(6,588,019)	9,106,593	127,234	—	—
Fundação PT	335,125	—	2,323	1,807,004	68,374	(1,900,000)	—
PT Pro	307,551	(3,217,789)	(32,942,494)	17,239,484	3,997	—	—
PT SI	288,119	(8,745,728)	(14,842,989)	2,346,955	1,220,125	(13,251)	—
PT CC	18,254	—	(36,321,273)	10,764,631	1,203,812	—	—
INESC	13,249	—	—	48,470	15,840	—	(1,995,192)
SIRESP	12,720	—	—	—	1,187,696	—	—
PT II	6,186	—	225	1,668,727	156,308	(21,328)	—
PT SGPS	412	—	—	—	348,273	(88)	(12,092,103)
PT Sales	5	—	(42,717,622)	3,173,627	60,841	—	—
PT Portugal	—	—	—	1,082,183	—	—	(185,221,469)
Other	932,948	(1,428,943)	(380,400)	785,919	182,325	(101,183)	(102,720)
	<u>121,490,028</u>	<u>(160,296,351)</u>	<u>(205,625,378)</u>	<u>58,473,199</u>	<u>28,190,673</u>	<u>(2,329,853)</u>	<u>(196,406,644)</u>

PT Comunicações
Notes to Financial Statements (Continued)
As at 31 December 2013
(Amounts in Euro)

12. Related parties (Continued)

	2012						Net interest expenses
	Sales and services rendered	Costs of services rendered	Supplies and external services	Wages and salaries ^(a)	Other operating income and gain	Other operating expenses and losses	
	Euro						
Meo, SA	164,965,708	(111,976,275)	(6,968,237)	4,752,819	16,928,352	(17,177)	14,056,685
UNITEL	10,345,303	(4,077,035)	—	—	170,011	(37,794)	—
CST	2,401,232	(1,206,169)	—	—	1,391,761	—	—
Páginas Amarelas	2,054,498	(26,423,673)	33,218	—	1,560	—	—
Timor Telecom	1,987,507	(3,019,038)	—	350,372	119,413	(48,286)	—
PT Contact	1,856,728	(1,039,335)	(66,361,944)	11,066,703	4,425,989	—	—
CVT	1,139,618	(8,243,991)	(129,642)	—	120	(9,242)	—
MTC	1,120,661	(543,470)	—	—	17,540	(7,835)	—
CV Multimédia	767,650	(13,143)	—	—	—	—	—
Vortal—Comércio Electrónico, Consultadoria e Multimédia, S.A.	653,768	—	(9,320)	—	145	—	—
Fibroglobal	459,448	—	—	55,314	—	(2,970)	3,262
PT Inovação	371,134	(1,003,497)	(6,938,224)	9,349,102	107,125	—	—
Fundação PT	330,305	—	7,175	1,505,558	217,566	(25,772)	—
PT PRO	304,815	(6,505,698)	(33,130,277)	17,053,348	16,413	—	—
Multitel—Serviços de Telecomunicações Lda	283,883	(427,458)	(95,483)	—	1,931	(6,404)	—
PT SI	173,205	(9,599,102)	(20,815,238)	1,890,084	1,336,637	—	—
PT CC	55,639	—	(38,758,871)	8,952,942	1,074,208	—	—
PT Compras	21,988	—	244	1,818,315	326,415	—	—
Siresp	12,242	—	(172)	—	1,141,565	—	—
PT Sales	7,519	—	(49,151,733)	3,226,378	64,174	—	—
PT II	6,898	—	225	1,932,968	150,946	(417)	—
PT SGPS	691	—	—	90,322	342,230	—	(14,332,391)
PT Portugal	—	—	—	684,964	—	—	(144,625,092)
PT ACS	—	—	(83,123)	(3,614,777)	72,300	—	—
Other	573,657	(926,554)	(729,309)	616,015	65,370	(83,477)	—
	189,894,097	(175,004,438)	(223,130,711)	59,730,427	27,971,771	(239,374)	(144,897,536)

(a) Transactions with related parties included under this caption correspond primarily to gains resulting from amounts charged to other Group entities related to the Company's employees which are currently working in those other entities.

12.4. Other information

Remunerations of the Company's executive and non-executive board members in 2013 and 2012 were as follows:

	2013	2012
	Euro	
Accountant		
Statutory audit fees	50,000	50,000
Audit related services fees	—	7,000
	50,000	57,000

The remunerations of Board members are fully supported by PT Portugal.

PT Comunicações
Notes to Financial Statements (Continued)
As at 31 December 2013
(Amounts in Euro)

13. Deferrals

As at 31 December 2013 and 2012, this caption consisted of the following:

	2013	2012
	Euro	
PREPAID EXPENSES		
Current		
Direct costs	6,954,434	7,242,623
Interest and other financial expenses	6,003,406	7,458,782
Maintenance	851,418	1,117,278
Rentals	461,008	433,719
Telephone directories	413,499	726,752
Other	1,337,218	1,012,508
Total current	16,020,983	17,991,662
Total prepaid expenses	16,020,983	17,991,662
DEFERRED INCOME		
Non- current		
Transfer of rights of telecom infrastructure use	—	665,145
Total non- current	—	665,145
Current		
Penalties imposed to customers relating to violations of contracts ^(a)	68,767,241	45,827,448
Advance billing	14,627,803	19,375,671
Assignment of user rights for submarine cable stations	1,947,864	1,678,943
Transfer of rights of telecom infrastructure use	686,251	3,583,034
Other	6,561,347	3,853,817
Total current	92,590,506	74,318,913
Total deferred income	92,590,506	74,984,058

(a) The increase in this caption relates to penalties for violation of contracts by customers of the Pay-tv service and certain irregularities undertaken by other operators regarding the portability of customers.

14. Other financial assets

As at 31 December 2013 and 2012, these captions consist of the following:

	2013	2012
	Euro	
Accounts receivable—trade (Note 17)	76,189	365,032
Other ^(a)	4,001,661	8,599
Total	4,077,850	373,631

(a) This caption includes loans granted in 2013 to the subsidiary Fibroglobal amounting to Euro 4,000,000.

PT Comunicações
Notes to Financial Statements (Continued)
As at 31 December 2013
(Amounts in Euro)

15. Income taxes

15.1. Introduction

In 2013, companies located in mainland Portugal are subject to Corporate Income Tax at a base rate of 25%, increased (1) up to a maximum of 1.5% of taxable income through a municipal tax, and (2) by a state surcharge levied at the rate of 3.0% on taxable income between Euro 1.5 million and Euro 7.5 million (Euro 10.0 million in 2012) and at the rate of 5.0% on taxable income in excess of Euro 7.5 million (Euro 10.0 million in 2012).

As from 2014, companies located in mainland Portugal are subject to Corporate Income Tax at a base rate of 23%, increased (1) up to a maximum of 1.5% of taxable income through a municipal tax, and (2) by a state surcharge levied at the rates of 3.0% on taxable income between Euro 1.5 million and Euro 7.5 million, 5.0% on taxable income between Euro 7.5 million and Euro 35.0 million and 7.0% on taxable income in excess of Euro 35.0 million, resulting in a maximum aggregate tax rate of approximately 31.5% for taxable income higher than Euro 35.0 million.

As the Company reported tax losses for both years ended 31 December 2013 and 2012, neither the 1.5% municipal tax nor the state taxes are applicable. Consequently, and based on its expectations regarding future taxable results, PT Comunicações used the 23% and 25% tax rates for purposes of computing deferred taxes, at 31 December 2013 and 2012, respectively.

The Company's income taxes are computed based on the tax rate mentioned above and are determined on the basis of profit before-tax adjusted in accordance with tax legislation.

The Company is part of the Special Taxation Regime for Groups of Companies (RETGS) whose dominant company is PT SGPS, so the income tax estimate and deductions made by third parties are recorded on the balance sheet as accounts payable and receivable of PT SGPS.

In accordance with the prevailing legislation, taxation returns are subject to review and correction by the tax authorities during a period of four years (five years for Social Security, Security), except where there have been tax losses, fiscal benefits have been granted, or there are inspections, claims or challenges pending; in such cases, these periods may be extended or suspended, depending on the circumstances. Based upon the information supplied by its tax advisory services, the Board of Directors considers that any corrections to the tax returns that might result from reviews carried out by the tax authorities will not have a significant effect on the financial statements as at 31 December 2013, considering the provisions recorded and the current expectations of settlement regarding tax contingencies described in Note 22.

15.2. Deferred taxes

As mentioned in Note 3.11, deferred tax assets are recognised to the extent that it is reasonably likely that taxable income will be available against which deductible temporary differences can be used, or when there are deferred tax liabilities the reversal of which is expected in the same period in which the deferred tax assets reverse. PT Comunicações believes that deferred tax assets recorded in the Balance Sheet are recoverable either through its future taxable income, based on its budget for the year 2014 and projections of results for the subsequent years adjusted for differences between the accounting and taxable earnings and for certain financial operations to be undertaken in the future, or through the reversal of deferred tax liabilities.

In assessing income tax expenses for the year, in addition to the current tax determined on the basis of profit before-tax adjusted in accordance with tax legislation, the effects of temporary differences between income before tax and taxable earnings arising in the given year or in previous years is also considered.

PT Comunicações
Notes to Financial Statements (Continued)
As at 31 December 2013
(Amounts in Euro)

15. Income taxes (Continued)

Movements occurred in deferred tax assets during the years ended 31 December 2013 and 2012 were as follows:

	2013					Total
	Post retirement benefits	Impairment of accounts receivable	Depreciation and amortisation tangible assets	Other provision and adjustments	Other temporary differences	
	Euro					
Opening balance	281,272,183	10,276,194	9,766,858	2,207,224	7,221,339	310,743,798
Increases (reductions)						
Net income	(5,523,240)	(3,047,694)	1,698,488	617,009	(559,162)	(6,814,599)
Shareholders' equity (Note 21.4)	34,696,499	—	—	—	—	34,696,499
Change in the statutory tax rate						
Net income	(11,287,075)	(578,280)	(917,228)	(225,939)	(532,974)	(13,541,496)
Shareholders' equity (Note 21.4)	(13,548,560)	—	—	—	—	(13,548,560)
Closing balance	<u><u>285,609,807</u></u>	<u><u>6,650,220</u></u>	<u><u>10,548,118</u></u>	<u><u>2,598,294</u></u>	<u><u>6,129,203</u></u>	<u><u>311,535,642</u></u>

	2013						Total
	Post retirement benefits	Additional contribution to pension funds	Impairment of accounts receivable	Depreciation and amortization of tangible	Other provision and adjustments	Other temporary differences	
	Euro						
Opening balance	286,308,291	4,684,889	—	9,732,610	2,330,385	5,085,030	308,141,205
Increases (reductions)							
Net income	(16,437,044)	(4,684,889)	10,276,194	34,248	(123,161)	2,136,309	(8,798,343)
Shareholders' equity (Note 21.4)	11,400,936	—	—	—	—	—	11,400,936
Closing balance	<u><u>281,272,183</u></u>	<u><u>—</u></u>	<u><u>10,276,194</u></u>	<u><u>9,766,858</u></u>	<u><u>2,207,224</u></u>	<u><u>7,221,339</u></u>	<u><u>310,743,798</u></u>

Movements occurred in deferred tax liabilities during the years ended 31 December 2013 and 2012 were as follows:

	2013			Total
	Assets revaluation	Earnings not attributed to associated companies	Capital gain with deferred taxation	
	Euro			
Opening balance	171,519,487	1,133,959	1,053,237	173,706,683
Increases (reductions)				
Net income	(10,526,934)	(951,103)	(520,215)	(11,998,252)
Shareholders' equity (Notes 21.5)	—	(182,856)	—	(182,856)
Change in the statutory tax rate				
Net income	—	—	(42,642)	(42,642)
Shareholders' equity (Note 21.6)	(12,879,404)	—	—	(12,879,404)
Closing balance	<u><u>148,113,149</u></u>	<u><u>—</u></u>	<u><u>490,380</u></u>	<u><u>148,603,529</u></u>

	2012			Total
	Assets revaluation	Earnings not attributed to associated companies	Capital gain with deferred taxation	
	Euro			
Opening balance	182,457,075	1,131,131	1,341,723	184,929,929
Increases (reductions)				
Net income	(10,937,588)	33,262	(288,486)	(11,192,812)
Shareholders' equity (Note 21.5)	—	(30,434)	—	(30,434)
Closing balance	<u><u>171,519,487</u></u>	<u><u>1,133,959</u></u>	<u><u>1,053,237</u></u>	<u><u>173,706,683</u></u>

PT Comunicações
Notes to Financial Statements (Continued)
As at 31 December 2013
(Amounts in Euro)

15. Income taxes (Continued)

15.3. Tax rate reconciliation

In 2013 and 2012, the reconciliation between the expected tax computed by applying the nominal tax rate to income before taxes and the total income tax is as follows:

	2013	2012
	Euro	
Income before taxes	(200,347,849)	(93,674,776)
Nominal tax rate	25.00%	25.00%
Expected tax	(50,086,962)	(23,418,694)
Permanent differences ^(a)	(45,972,128)	(28,719,166)
Tax loss used in connection with RETGS ^(b)	90,846,088	170,121,916
Effect of the change in tax rate	13,498,854	—
Collection adjustments	1,819,982	1,909,491
Write- off / Derecognition of deferred tax assets ^(c)	—	(113,579,000)
Surplus of prior year accrued income tax	(257,730)	(1,859,485)
Other	29,351	(6,799,524)
	9,877,455	(2,344,462)
Income tax		
Income tax- current	1,562,254	50,007
Deferred tax	8,315,201	(2,394,469)
	9,877,455	(2,344,462)

(a) Permanent differences are as follows:

	2013	2012
	Euro	
Equity method of accounting (Note 27) ⁽ⁱ⁾	(201,666,537)	(117,696,638)
Provisions and adjustments not deductible for tax purposes	23,683,108	7,495,389
Disposal of CTM ⁽ⁱⁱ⁾	(2,112,732)	—
Write- off of accounts receivable	534,816	743,000
Recognition of capital gains and losses ⁽ⁱⁱⁱ⁾	(1,592,844)	(660,323)
Tax benefits	(3,969,590)	(3,185,478)
Other	1,235,269	(1,572,614)
	(183,888,510)	(114,876,664)
Nominal tax rate	25.00%	25.00%
	(45,972,128)	(28,719,166)

(i) In 2012, except for the Company's share in the earnings of CTM, for which we recognized a positive deferred tax, gains and losses in affiliated companies represent permanent differences.

(ii) This caption reflects the impact non-taxable gains, recorded upon the disposal of the investment in CTM (Note 20).

(iii) This caption refers to the difference between the accounting capital gains and losses and corresponding tax capital gains and losses related to the disposal of fixed assets.

(b) This caption corresponds to the taxable loss computed in both years by the Company in accordance with Income Tax legislation. In accordance with the fiscal policy set by Portugal Telecom Group, the gain related to the use of these tax losses has been recorded at the group level in PT SGPS' financial statements.

PT Comunicações
Notes to Financial Statements (Continued)
As at 31 December 2013
(Amounts in Euro)

15. Income taxes (Continued)

- (c) Based on its expectation regarding its individual tax results, the Company in 2011 wrote off a portion of deferred tax assets related to post-retirement benefits that would have been used in 2012, since it believes that the referred tax results will not be enough to allow the use of these deferred tax assets. In 2012, the Company incurred in the tax costs associated with the deferred taxes derecognized in 2011, which therefore contributed to the tax loss generated in the year 2012, as detailed in the table above, and led to the permanent difference presented in 2012.

15.4. Other information

In connection with the Law 40/2005, of August 3, which approved the program SIFIDE—Tax Incentives on Research and Development System, the Company filed in 2013 the application related to the year 2012, amounting to Euro 578,170.

Under the law 10/2009 of March 10, which approved the RFAI—Tax Regime to Support Investment, the Company included in its 2012 income tax declaration form a tax benefit amounting to Euro 5,769,684, related to the significant investments made on the creation of new generation broadband networks.

In 2013, it was approved the Law 49/2013 of 16 July, which establishes an Extraordinary Tax Credit on Investment in the form of an income tax deduction amounting to 20% of the investments related to the company's operations that are realized after 1 June 2013. In the entities that are included in the tax consolidation regime, that deduction will be realized based on the Group's taxable income, and the amount that cannot be deducted may be used in the subsequent five fiscal years, in the same conditions. The Company is evaluation weather will use this benefit or not, based on the investment realized in 2013, the maximum amount of which eligible for tax purposes is Euro 5,122,814, and as such did not reflect this matter in the financial statements.

16. Inventories

As at 31 December 2013 and 2012, this caption consists of the following:

	2013			2012		
	Gross value	Impairment losses	Net value	Gross value	Impairment losses	Net value
	Euro					
Goods	24,238,390	(9,554,491)	14,683,899	39,253,567	(10,310,480)	28,943,087
Raw materials and consumables	18,401,315	(1,577,504)	16,823,811	22,264,647	(1,574,336)	20,690,311
Work in progress	(796,234)	—	(796,234)	(723,425)	—	(723,425)
	<u>41,843,471</u>	<u>(11,131,995)</u>	<u>30,711,476</u>	<u>60,794,789</u>	<u>(11,884,816)</u>	<u>48,909,973</u>

The cost of products sold was determined as follows:

	2013			2012		
	Goods	Materials	Total	Goods	Materials	Total
	Euro					
Opening balance	39,253,567	22,264,647	61,518,214	47,441,728	24,094,933	71,536,661
Purchases	77,931,344	33,955,104	111,886,448	109,250,244	52,331,420	161,581,664
Adjustments ^(a)	(74,892,824)	(30,925,818)	(105,818,642)	(91,569,563)	(48,391,866)	(139,961,429)
Closing balance	24,238,390	18,401,315	42,639,705	39,253,567	22,264,647	61,518,214
Costs of products sold and materials consumables	<u>18,053,697</u>	<u>6,892,618</u>	<u>24,946,315</u>	<u>25,868,842</u>	<u>5,769,840</u>	<u>31,638,682</u>

- (a) Adjustments to inventories refer mainly to transfers to fixed assets, upon the installation of terminal equipment leased to customers and materials installed in building network infrastructures.

PT Comunicações
Notes to Financial Statements (Continued)
As at 31 December 2013
(Amounts in Euro)

16. Inventories (Continued)

The production variation in 2013 and 2012 is as follows:

	2013	2012
	Euro	
Opening balance	723,425	(789,102)
Adjustments	1,135,904	—
Closing balance	(796,234)	(723,425)
Production variation	<u>1,063,095</u>	<u>(1,512,527)</u>

In the years ended as at 31 December 2013 and 2012, the evolution of accumulated impairment losses relative to inventories was as follows:

	2013			2012		
	Goods	Materials	Total	Goods	Materials	Total
	Euro					
Opening balance	10,310,480	1,574,336	11,884,816	15,851,031	2,389,398	18,240,429
Increases	284,215	3,168	287,383	3,716,474	—	3,716,474
Reversals	(1,040,204)	—	(1,040,204)	(6,468,289)	(815,062)	(7,283,351)
Utilizations	—	—	—	(2,788,736)	—	(2,788,736)
Closing balance	<u>9,554,491</u>	<u>1,577,504</u>	<u>11,131,995</u>	<u>10,310,480</u>	<u>1,574,336</u>	<u>11,884,816</u>

17. Accounts receivables and unbilled revenues

As at 31 December 2013 and 2012, this caption consists of:

	2013			2012		
	Gross value	Impairment losses	Net value	Gross value	Impairment losses	Net value
	Euro					
Trade accounts receivable— current assets	589,980,787	(128,449,223)	461,531,564	624,272,775	(154,117,676)	470,155,099
Trade accounts receivable— non-current assets (Note 14)	76,189	—	76,189	365,032	—	365,032
Accounts receivable	<u>590,056,976</u>	<u>(128,449,223)</u>	<u>461,607,753</u>	<u>624,637,807</u>	<u>(154,117,676)</u>	<u>470,520,131</u>
Unbilled revenues	88,412,138	—	88,412,138	64,005,319	—	64,005,319
	<u>678,469,114</u>	<u>(128,449,223)</u>	<u>550,019,891</u>	<u>688,643,126</u>	<u>(154,117,676)</u>	<u>534,525,450</u>

In the years ended as at 31 December 2013 and 2012, the evolution of accumulated impairment losses related to accounts receivable was as follows:

	2013	2012
	Euro	
Opening balance	154,117,676	177,563,099
Reti merger	—	1,953
Increases (reversals)	22,960,728	25,750,763
Utilizations ^(a)	(48,629,181)	(49,198,139)
Closing balance	<u>128,449,223</u>	<u>154,117,676</u>

(a) This caption corresponds to the write-off of receivables that were previously fully adjusted for through the use of accumulated impairment losses.

PT Comunicações
Notes to Financial Statements (Continued)
As at 31 December 2013
(Amounts in Euro)

17. Accounts receivables and unbilled revenues (Continued)

The Company is exposed to the credit risk arising from the possibility that a third party does not fulfil its contractual obligations, resulting in a financial loss. The credit risk is primarily related to accounts receivable from services provided to customers and is monitored regularly with the following objectives: (a) limit the credit granted to customers, considering their profile and aging of receivables; (b) monitor the evolution of the credit level granted; (c) make regular reviews of the receivables recoverability; (d) analysis of market risk where the customer is located. The Company is not exposed to any significant credit risk related to a particular customer, to the extent that its receivables arise from a large number of customers.

As at 31 December 2013 and 2012, the aging of receivables, net of impairment losses, was as follows:

	2013			2012		
	Accounts receivable from group companies	Accounts receivable from other companies	Total	Accounts receivable from group companies	Accounts receivable from other companies	Total
	Euro					
Unexpired balance	42,608,964	221,010,359	263,619,323	69,799,276	200,206,525	270,005,801
Expired balance						
0 - 60 days	12,989,475	59,198,336	72,187,811	21,946,132	59,967,759	81,913,891
60 - 90 days	1,394,253	12,051,217	13,445,470	1,523,605	13,832,752	15,356,357
90 - 180 days	4,679,416	24,538,629	29,218,045	3,633,891	25,682,526	29,316,417
180 - 360 days	7,430,439	28,506,439	35,936,878	5,089,602	29,449,088	34,538,690
360 - 720 days	4,715,807	14,327,098	19,042,905	1,457,161	22,052,724	23,509,885
More than 720 days	1,238,234	26,919,087	28,157,321	781,305	15,097,785	15,879,090
Accounts receivable	75,056,588	386,551,165	461,607,753	104,230,972	366,289,159	470,520,131

Some of the accounts receivable with a higher aging relate to penalties for contracts violation imposed to customers and other operators, the revenues of which were deferred, as mentioned in Note 13.

18. State and other public entities

As at 31 December 2013 and 2012, the balances with these entities were as follows:

	2013		2012	
	Debit balances	Credit balances	Debit balances	Credit balances
	Euro			
Value added tax ^(a)	—	2,988,848	150,458	18,247,876
Social security taxes	—	8,199,142	—	7,518,077
Personnel income taxes	—	7,236,881	—	12,638,888
Municipality taxes	—	531,602	—	431,181
Corporate income taxes	—	—	—	5,533
Other taxes	—	25,754	43,294	2,998
	—	18,982,227	193,752	38,844,553

(a) As at 31 December 2013, this caption refers to the Value Added Tax payable regarding the month of December, which includes the tax recoverable determined in November and carried over to the following month. As at 31 December 2012, this caption includes Value Added Tax payable regarding the months of November and December, amounting to Euro 7,181,420 end Euro 11,066,456, respectively.

PT Comunicações
Notes to Financial Statements (Continued)
As at 31 December 2013
(Amounts in Euro)

19. Other accounts receivable and payable

As at 31 December 2013 and 2012, these captions consisted of the following:

	2013	2012
	Euro	
OTHER ACCOUNTS RECEIVABLE		
Current		
Group companies ^(a)	6,074,634	27,865,224
Several charges ^(b)	17,477,101	15,106,226
SNS—Comparticipação no Plano de Saúde ^(c)	8,225,736	8,225,736
Personnel	4,023,515	2,968,286
European Community subsidies	531,853	49,857
Other accounts receivable ^(d)	95,385,116	71,918,438
Total current	131,717,955	126,133,767
Accumulated impairment losses	(8,261,557)	(8,245,012)
Total other accounts receivable	123,456,398	117,888,755
OTHER ACCOUNTS PAYABLE		
Current		
PT ACS	1,287,448	2,327,116
Personnel	917,618	829,894
Group companies	38,309	15,942
Other accounts payable ^(e)	26,539,020	11,783,064
Total current	28,782,395	14,956,016

(a) The reduction in this caption correspond mainly to interest in connection with loans granted, which were repaid in 2013 (Note 12).

(b) This caption includes mainly accounts receivable related with equipment's sale to occasional customers.

(c) The balances related to Serviço Nacional de Saúde correspond to the amount receivable by the Company regarding the State co-participation in the costs of healthcare plan.

(d) The increase in this caption reflects mainly a gain of approximately Euro 31 million recorded in 2013 related to (i) an amount of Euro 5 million relates to the net compensation receivable from the Portuguese State for prior years costs supported by PT Comunicações with the universal service obligation under the Concession Agreement, in accordance with Law 66/2012, and (ii) an amount of Euro 26 million following the early termination of the concession contract by the Portuguese State assigning the universal service to other operator.

(e) The change in this caption is primarily explained by an amount of Euro 15,236,897 paid by PT Prestações in 2013, in connection with a transfer of receivables from public entities to this company.

During the years ended 31 December 2013 and 2012, the evolution in accumulated impairment losses related to accounts receivable was as follows:

	2013	2012
	Euro	
Opening balance	8,245,012	8,721,353
Increases	16,545	9,319
Reversals	—	(485,660)
Closing balance	8,261,557	8,245,012

PT Comunicações
Notes to Financial Statements (Continued)
As at 31 December 2013
(Amounts in Euro)

20. Non-current assets held for sale

The composition of non-current assets held for sale as at 31 December 2013 and 2012 is as follows:

	2013	2012
	Euro	
Opening balance	5,069,882	—
Acquisition of Sportinvest Multimédia ⁽ⁱ⁾	4,653,742	—
Transfer of the CTM from the caption “Financial investments-equity method of accounting” (Note 10)	—	5,069,882
Sale of the stake in CTM (Note 10)	(2,309,932)	—
Dividends CTM (Note 10)	(2,759,950)	—
Closing balance	<u>4,653,742</u>	<u>5,069,882</u>

(i) This stake was acquired for an amount of 32,618,669 euros (Note 4), corresponding to the nominal value of additional paid and supplies granted to this entity, and was recognized an impairment loss in the amount of EUR 27,964,927 (Note 33) to meet the estimated realizable value.

a) CTM

On 13 January 2013, Portugal Telecom entered into a definitive agreement for the sale to CITIC Telecom of its 28% equity stake held in CTM and as such this investment was classified as a non-current asset held for sale as at 31 December 2012. Upon the closing of this transaction on 20 June 2013, PT Comunicações received a total amount of Euro 35,966,391 (Notes 1 (b), 4 (b) and 10) by its 3% stake in the share capital of CTM, and recognized a gain of Euro 32,729,421 (Note 27), which includes: (1) a gain of Euro 33,656,459 corresponding to the difference between the proceeds obtained from this transaction and the carrying value of this investment as at 31 December 2012, of Euro 5,069,882, net of dividends received during the first quarter of 2013, amounting to Euro 2,759,950 and a loss of Euro 927,038 (Note 21.5) corresponding to the cumulative amount of negative foreign currency translation adjustments relating to this investment that were reclassified to profit and loss upon the completion of the sale.

b) Sportinveste Multimédia

On 20 December 2012, Portugal Telecom reached an agreement on a number of transactions that will allow Portugal Telecom to have a 25% stake in a joint-venture that will combine Sport TV Portugal S.A. (“Sport TV”), Sportinveste Multimédia SGPS, S.A. (“Sportinveste Multimédia”) and P.P. TV—Publicidade de Portugal e Televisão, S.A. (“PPTV”). Portugal Telecom will contribute its current 50% stake in Sportinveste Multimédia and invest, through a rights issue in Sport TV, a net amount of up to Euro 21 million. Following these transactions, Portugal Telecom will own 25% of Sport TV, which will incorporate PPTV and Sportinveste Multimédia. As a result of this agreement, Portugal Telecom’s investment in Sportinveste Multimédia was classified as a non-current asset held for sale as at 31 December 2012, the carrying value of which amounted to Euro 5 million as of that date. This investment in Sportinveste Multimédia was disposed of in 2013 by PT SGPS to PT Comunicações (Note 1 b)), having been also classified as non-current asset held for sale by the recoverable amount of this investment.

Sport TV produces one of the most complete and broad sports content offering worldwide and PPTV promotes television rights. Sportinveste Multimédia is currently equally owned by Portugal Telecom and Sportinveste SGPS and its core business is the production and development of sports contents through any multimedia platform. This transaction will result in a joint-venture that will allow a higher operational efficiency in management of sports contents in the various distribution platforms, including pay-TV, mobile networks and Internet. This will benefit all operators in the market as well as their customers. Taking into consideration that sports contents are core to its strategy in the various market segments,

PT Comunicações
Notes to Financial Statements (Continued)
As at 31 December 2013
(Amounts in Euro)

20. Non-current assets held for sale (Continued)

Portugal Telecom will continue to distribute other sports contents thus striving to retain a diversified and competitive offer to its customers.

On 31 December 2013, these corporate transactions are subject to the approval of the competent authorities, particularly the Competition Authority—Autoridade da Concorrência, and the accomplishment of certain contractual conditions by the companies involved, including the conclusion of Sport TV's refinancing following the transaction.

21. Shareholders' equity

21.1. Share capital

As at 31 December 2013 and 2012, the Company's share capital was fully paid and amounted to Euro 1,150,000,000 and was represented by 1,150,000,000 nominal shares (Note 36), with a nominal value of 1 Euro each. As at 31 December 2013 and 2012, the entirety of the Company's share capital was held by PT Portugal.

21.2. Other shareholders' equity instruments

This caption corresponds to additional paid in capital contributions granted by PT Portugal, which do not bear interest and have no reimbursement term defined. In accordance with applicable law, reimbursement may be made only if, after payment, shareholders' equity is greater than the sum of capital, legal reserves and unrealised revaluation reserves.

21.3. Legal reserve

Portuguese law provides that at least 5% of annual profits must be appropriated to a legal reserve until this reserve equals the minimum requirement of 20% of share capital. This reserve is not available for distribution to shareholders but may be capitalized or used to absorb losses, once all other reserves and retained earnings have been exhausted.

21.4. Other reserves

During the years ended 31 December 2013 and 2012, the movements under this caption were as follows:

	Net actuarial losses	Free reserves	Total
		Euro	
Balance as at 1 January 2012	(369,029,838)	699,003,873	329,974,035
Actuarial losses			
Base (Note 11.7)	(45,603,748)	—	(45,603,748)
Tax effect (Note 15)	11,400,936	—	11,400,936
Balance as at 31 December 2012	(403,232,650)	699,003,873	295,771,223
Actuarial losses			
Base (Note 11.7)	(138,786,000)	—	(138,786,000)
Tax effect (Note 15)	34,696,499	—	34,696,499
Change in tax rate (Note 15)	(13,548,560)	—	(13,548,560)
Balance as at 31 December 2013	(520,870,711)	699,003,873	178,133,162

PT Comunicações
Notes to Financial Statements (Continued)
As at 31 December 2013
(Amounts in Euro)

21. Shareholders' equity (Continued)

21.5. Adjustments to financial assets

During the years ended 31 December 2013 and 2012, the movements under this caption were as follows:

	Unpaid dividends	Foreign currency exchange differences ^(a)	Other changes in shareholders' equity ^(b)	Total
	Euro			
Balance as at 1 January 2012 . . .	25,432,194	(231,013,947)	(800,854)	(206,382,607)
Equity method	—	(350,270,498)	48,931,770	(301,338,728)
Dividends not received from subsidiaries and associated companies	50,868,659	—	—	50,868,659
Deferred taxes (Note 15.2)	—	30,434	—	30,434
Balance as at 31 December				
2012	76,300,853	(581,254,011)	48,130,916	(456,822,242)
Equity method	—	(534,611,613)	(6,826,726)	(541,438,339)
Dividends not received from subsidiaries and associated companies	250,643,469	—	—	250,643,469
Alienation of CTM (Note 20 a) . . .	—	927,038	879,912	1,806,950
Alienation of PT Brasil	—	5,667	8,605	14,272
Deferred taxes (Note 15.2)	—	182,856	—	182,856
Balance as at 31 December				
2013	326,944,322	(1,114,750,063)	42,192,707	(745,613,034)

(a) The foreign currency exchange differences determined following the application of the equity method of accounting are related to the update of financial investment in Oi, which is indirectly owned through the affiliated company MEO, SA.

(b) In 2012, other changes in shareholders' equity resulting from the equity method of accounting include primarily a gain recorded by Bratel Brasil (a company of PT Group that holds the investment in Oi Group and is held indirectly by MEO, SA), amounting to Euro 49 million, corresponding to the impact of a corporate restructuring undertaken by the Oi Group in March 2012.

Movements related to the equity method of accounting were recorded under the following captions:

	2013	2012
	Euro	
Investments in subsidiaries and associated companies (Note 10) . . .	(541,439,013)	(301,338,547)
Provision for negative financial investments (Note 22.5)	674	(181)
	(541,438,339)	(301,338,728)

PT Comunicações
Notes to Financial Statements (Continued)
As at 31 December 2013
(Amounts in Euro)

21. Shareholders' equity (Continued)

21.6. Revaluation surplus

During the years ended 31 December 2013 and 2012, the movements under this caption were as follows:

	2013	2012
	Euro	
Opening balance	589,044,034	623,874,447
Realization of revaluation surplus		
Base	(44,956,340)	(45,768,002)
Tax effect	10,526,934	10,937,589
Impact of change in tax rate (Note 15.2)	12,879,404	—
Closing balance	<u>567,494,032</u>	<u>589,044,034</u>

In accordance with the applicable legislation and the accounting practices used in Portugal, the revaluation reserves cannot be distributed to shareholders; they can only be used, under certain circumstances and in accordance with Portuguese legislation, for future capital increases.

The revaluation reserves recognized under this caption are related to both (1) assets measured in accordance with the revaluation model, and also (Note 6.2), (2) other assets revalued previously, for which the Company, in connection with the adoption of SNC and as permitted by NCRF 3, adopted the cost model. The Company decided to include both of these revaluation reserves under this caption as they are both non-distributable to shareholders, as mentioned above.

Annually, PT Comunicações transfers to retained earnings the revaluation reserve realized in the year, primarily through the depreciation of the asset that originated these reserves. The amounts transferred during the years ended 31 December 2013 and 2012, net of the corresponding tax effects, amounted to Euro 34,429,406 and Euro 34,830,413, respectively.

21.7. Other shareholders' equity

PT Comunicações recognises under this caption subsidies associated with the acquisition or production of non-current assets (investment subsidies), which were entirely received and are non-refundable, where the Company is not under obligation to comply with conditions associated with the subsidy.

These subsidies are subsequently recognized in earnings during the useful lives of the related assets for which those subsidies were granted. The Company recognized gains amounting to Euro 2,150,776 in 2013 and Euro 2,997,997 in 2012 (Note 32). The balance of this caption corresponds to the remaining amount of subsidies that have not yet been recognized in earnings.

21.8. Application of earnings

In 2012, as approved by the General Shareholders Meeting held on 29 March 2012, the negative net income of 2011, was entirely transferred to the caption "Retained earnings".

In 2013, as approved by the General Shareholders Meeting held on 27 March 2013, the negative net income of 2012 was entirely transferred to the caption "Retained earnings".

PT Comunicações
Notes to Financial Statements (Continued)
As at 31 December 2013
(Amounts in Euro)

22. Provisions, contingent liabilities and contingent assets

22.1. Movements occurred in provisions

During the years ended 31 December 2013 and 2012, the movements in provisions were as follows:

	2013				
	Tax claims	Other litigation	Provision for negative financial investments (Note 12)	Other provisions	Total
	Euro				
Opening balance	14,908,002	9,674,993	297,348	61,240	24,941,583
Increases	1,321,681	1,343,448	102,912	1,646,721	4,414,762
Reductions	(5,896,106)	(4,544,954)	—	—	(10,441,060)
Utilizations	(5,215,159)	—	—	(729,553)	(5,944,712)
Closing balance	5,118,418	6,473,487	400,260	978,408	12,970,573
Current	5,118,418	6,473,487	—	978,408	12,570,313
Non-current	—	—	400,260	—	400,260
	<u> </u>	<u> </u>	<u> </u>	<u> </u>	<u> </u>
	2012				
	Tax claims	Other litigation	Provision for negative financial investments (Note 12)	Other provisions	Total
	Euro				
Opening balance	14,629,879	9,674,288	292,057	1,162,606	25,758,830
Increases	9,079,743	1,601,337	5,291	1,113,060	11,799,431
Reductions	(2,004,714)	(1,600,632)	—	(6,984)	(3,612,330)
Utilizations	(6,796,906)	—	—	(2,207,442)	(9,004,348)
Closing balance	14,908,002	9,674,993	297,348	61,240	24,941,583
Current	14,908,002	9,674,993	—	61,240	24,644,235
Non-current	—	—	297,348	—	297,348
	<u> </u>	<u> </u>	<u> </u>	<u> </u>	<u> </u>

22.2 Claims and legal proceedings

a) Proceedings with probable losses

Provisions for tax claims and legal proceedings are related to liabilities arising from legal proceedings against the Company, and are computed based on the advice of PT Comunicações' tax and legal advisors.

PT Comunicações
Notes to Financial Statements (Continued)
As at 31 December 2013
(Amounts in Euro)

22. Provisions, contingent liabilities and contingent assets (Continued)

As at 31 December 2013 and 2012, there were several legal proceedings and tax contingencies which, in accordance with “NCRF 21 Provisions, Contingent Liabilities and Contingent Assets” (“NCRF 21”) and based on the opinion of the Company’s internal and external tax and legal counsels, were considered as probable losses, since the Company considered probable the outflow of resources to settle the obligation. The nature of these claims is as follows:

	<u>2013</u>	<u>2012</u>
	Euro	
Legal proceedings		
Civil contingencies	1,372,668	3,321,484
Labor contingencies	2,130,323	2,504,227
Other contingencies	2,970,496	3,849,282
	<u>6,473,487</u>	<u>9,674,993</u>
Tax contingencies	<u>5,118,418</u>	<u>14,908,002</u>
	<u>11,591,905</u>	<u>24,582,995</u>

Set forth below are several tax claims assessed as constituting a probable loss, namely related to a portion of the VAT and IRC tax assessments in regard to the years 1998 of Marconi and 1999 of Portugal Telecom, S.A., and the years 2002 to 2012 of PT Comunicações, among others, the Company has recorded a provision amounting to Euro 5,118,418 in 2013, including tax and interest. However, the Company is contesting these claims with the tax authorities.

b) Proceedings with possible losses

As at 31 December 2013 and 2012, the Company, in accordance with the definitions of NCRF 21 and based on the advice of its internal and external tax and legal counsels, had classified several claims and legal proceedings and tax contingencies as proceedings with possible losses. The nature of these proceedings is as follows:

	<u>2013</u>	<u>2012</u>
	Euro	
Legal proceedings		
Civil contingencies	70,241,929	74,163,129
Labor contingencies	542,461	478,806
Other contingencies	13,682,689	21,125,828
	<u>84,467,079</u>	<u>95,767,763</u>
Tax contingencies	<u>1,764,553</u>	<u>2,562,502</u>
	<u>86,231,632</u>	<u>98,330,265</u>

22.3 Description of the main claims with regulatory entities and other legal proceedings

The following litigation processes relate to the main claims and legal proceedings filed by regulatory entities against PT Comunicações, some of which the Company considers, based on the advice of its internal and external legal counsels that related losses are remote, in accordance with the definitions of NCRF 21.

a) Claims for municipal taxes and fees

Pursuant to a statute enacted on 1 August 1997, as an operator of a basic telecommunications network, Portugal Telecom was exempt from municipal taxes and rights-of-way and other fees with respect to its

PT Comunicações
Notes to Financial Statements (Continued)
As at 31 December 2013
(Amounts in Euro)

22. Provisions, contingent liabilities and contingent assets (Continued)

network in connection with its obligations under the Concession. The Portuguese Government has advised Portugal Telecom in the past that this statute confirmed the tax exemption under our Concession. The Portuguese Government has informed Portugal Telecom it will continue to take the necessary actions in order for PT Comunicações to maintain the economic benefits contemplated by the Concession.

Law 5/2004, dated 10 February 2004, established a new rights-of-way regime in Portugal whereby each municipality may establish a fee, up to a maximum of 0.25% of each wireline services bill, to be paid by the customers of those wireline operators whose network infrastructures are located in each such municipality. This regime was implemented in 2005 but does not affect the lawsuit described above based on the former statute. Meanwhile, Decree-Law 123/2009, dated 21 May 2009, clarified that no other tax should be levied by the municipalities in addition to the tax established by Law 5/2004. This interpretation was confirmed by the Supreme Administrative Court of Portugal in various legal actions.

Some municipalities however, continue to interpret that the Law 5/2004 does not expressly revoke other taxes that the municipalities wish to establish, because Law 5/2004 is not applicable to the public municipality domain. Currently, there are legal proceedings filed by some municipalities regarding this matter.

b) Regulatory proceedings

Portugal Telecom's operations are regularly subject to regulatory inquiries and investigations involving their operations. In addition, ANACOM (the telecommunications regulator), the European Commission, and the Autoridade da Concorrência (the competition authority) regularly make inquiries and conduct investigations concerning compliance with applicable laws and regulations. Current inquiries and investigations include several investigations by the (Autoridade da Concorrência) related to PT Comunicações for alleged anti-competitive practices in the Digital Terrestrial Television market. The Company believes that most of the complaints that have resulted in such investigations should be dismissed due to the nature of the alleged abuses and the novelty of the relevant antitrust laws. However, if PT Comunicações is found to be in violation of applicable laws and regulations in these or other regulatory inquiries and investigations, it could become subject to penalties, fines, damages or other sanctions. It is however permitted under Portuguese law to appeal any adverse decision to the Courts.

In April 2007, the Autoridade da Concorrência filed a complaint alleging that PT Comunicações abused its dominant market position by granting, in 2003, discriminatory discounts on lease lines. PT Comunicações challenged this claim with the authorities. However, on 1 September 2008, the Autoridade da Concorrência imposed a fine of Euro 2.1 million on PT Comunicações. PT Comunicações appealed to the Commerce Court of Lisbon, on 29 September 2008 and, on 29 February 2012, the Commerce Court of Lisbon cleared PT Comunicações of the fine. The Company, based on the opinion of its internal and external legal counsels, has not recorded any provision for this matter.

c) Other legal proceedings

In March 2004, TV TEL Grande Porto—Comunicações, SA. ("TVTEL"), a telecommunications company based in Oporto, filed a claim against PT Comunicações in the Lisbon Judicial Court. TV TEL alleged that, since 2001, PT Comunicações has unlawfully restricted access to its telecommunication ducts in Oporto, thereby undermining and delaying the installation and development of TV TEL's telecommunications network. TV TEL alleges that PT Comunicações intended to favor both itself and CATVP—TV Cabo Portugal, S.A, a PT Multimedia subsidiary and at the time a direct competitor of TV TEL. TV TEL is claiming an amount of approximately Euro 15 million from Portugal Telecom for damages and losses allegedly caused and yet to be sustained by that company as a result of the delay in the installation of its telecommunications network in Oporto. In addition, TV TEL has demanded that PT Comunicações be required to give full access to its ducts in Oporto. PT Comunicações submitted its

PT Comunicações
Notes to Financial Statements (Continued)
As at 31 December 2013
(Amounts in Euro)

22. Provisions, contingent liabilities and contingent assets (Continued)

defence to these claims, stating that: (1) TV TEL did not have a general right to install its network in PT Comunicações' ducts; (2) all of TV TEL's requests were lawfully and timely responded to by PT Comunicações according to its general infra-structure management policy; and (3) TV TEL's claims for damages and losses were not factually sustainable. On February 2013, the court decided a compensation related to increased costs of financing incurred and a value regarding loss of clients to be liquidated by TV TEL. Both parties have appealed.

In March 2011, Optimus—Comunicações S.A. ("Optimus") filed a claim against Portugal Telecom in the Judicial Court of Lisbon for the payment of approximately Euro 11 million and, in October 2011, Onitelem—Infocomunicações, S.A ("Oni") filed a claim against Portugal Telecom in the same court for the payment of approximately Euro 1.5 million, both related to a proceeding of the Autoridade da Concorrência that terminated in 2011 for prescription reasons, in relation to which Autoridade da Concorrência had imposed a fine to Portugal Telecom of approximately Euro 45 million. Optimus and Oni sustained their position by arguing that they suffered losses and damages as a result of Portugal Telecom's conduct. In the Optimus action, the Company is waiting for the schedule of the trial, while regarding the Oni legal action, Portugal Telecom was acquitted due to prescription reasons.

22.4 Other tax contingencies

In addition to the tax contingencies mentioned above, the risk of loss of which was deemed as either probable or possible (Note 22.2), there are other tax claims pending appeal or judicial decision, totalling Euro 21 million, which include primarily (1) tax assessments filed by the tax authorities with respect to the income tax from 1997 to 1998 of Portugal Telecom, SA and Marconi, and for 2002 and 2010 of PT Comunicações, and (2) additional payments of VAT from 2000 to 2004. The Company's opinion, based on the advice of its tax and legal counsel, is that the risk of loss associated with these claims is remote.

22.5 Provisions for losses on financial investments

Provisions for losses on financial investments are related to losses in subsidiaries and associated companies that have negative shareholders' equity (Note 12), and are computed based on the Company's share in the shareholders' equity of those entities. Movements in these provisions during the years ended 31 December 2013 and 2012 were as follows:

	<u>2013</u>	<u>2012</u>
	Euro	
Equity method		
Losses in subsidiaries and associated companies (Note 27)	2,446	5,110
Gains in subsidiaries and associated companies (Note 27)	(2,444)	—
Adjustments to financial assets (Note 21.5)	(674)	181
Acquisition of Yunit (Notes 1 and 4)	<u>103,584</u>	<u>—</u>
	<u>102,912</u>	<u>5,291</u>

22.6 Contingent assets

As at 31 December 2013, the main contingent asset relates to a request for the transmission of tax losses from PT.Com, a company that was merged into PT Comunicações in 2004, amounting to Euro 56 million. The recovery of this amount depends on the appeal filed by the Company. The request filed by the Company was overruled by the tax authorities on 2 February 2007, and the Company challenged this decision on 15 May 2007 through a special administrative proceeding, which is pending a final decision.

PT Comunicações
Notes to Financial Statements (Continued)
As at 31 December 2013
(Amounts in Euro)

23. Loans obtained

Loans obtained as at 31 December 2013 and 2012 have the following composition:

	2013		2012	
	Non-current	Current	Non-current	Current
	Euro			
Intragroup loans (Note 12.3)	3,779,000,000	—	3,527,000,000	—
Centralized cash management (Note 12.3)	—	342,322,714	—	117,962,274
Commercial programme	3,086,750,000	—	2,631,600,000	1,047,150,000
Leases	11,656,946	20,576,337	20,261,415	19,142,242
	6,877,406,946	362,899,051	6,178,861,415	1,184,254,516

23.1 Loans to Group companies

In March 2013, the Company obtained a loan from PT Portugal, amounting to Euro 252,000,000 (Note 4), as a result of which the total amount due increased to Euro 3,779,000,000. These loans have no defined maturity, but shall be repaid, partially or entirely, in more than one year, subject to the cash needs of the Company. The interest on these loans is linked to market rates.

23.2 Centralized cash management

As from March 2006, Portugal Telecom centralized all cash receipts and payments from Group companies located in Portugal. The financings obtained by the Company under this system have short term maturities and bear interest at market rates.

23.3 Commercial paper

On 25 June 1999, Portugal Telecom established a commercial paper program. Following subsequent amendments to this program, the maximum amount under this program as at 31 December 2013 is Euro 3,500,000,000. This program is in place until 7 July 2015, and is automatically renewable for two year periods, until 7 July 2025, unless one of the parties objects to it. As at 31 December 2013 and 2012, the Company had issued an amount of Euro 898,400,000 and Euro 1,440,400,000, respectively, under this program, which was fully subscribed by PT Finance.

On 1 June 2000, Portugal Telecom had issued another commercial paper program. Following subsequent amendments to this program, the maximum amount under this program as at 31 December 2013 is Euro 3,000,000,000. This program is in place until 1 June 2014, and is automatically renewable for two year periods, until 1 June 2020, unless one of the parties objects to it. As at 31 December 2013 and 2012, the Company had issued an amount of Euro 2,188,350,000 and Euro 2,238,350,000, respectively, under this program, which was fully subscribed by PT Finance.

23.4 Finance leases

Financial leasing obligations are essentially the result of: (i) lease contracts with respect to vehicles, under which there are generally purchase options at the end of their term, and (ii) contracts for the acquisition of satellite capacity, under which the Company has the right to use this capacity in the normal course of telecommunications operations, a right that is recorded by the Company as an intangible asset. The contracts for the acquisition of satellite capacity do not include purchase options but, generally, the Company has a preference in the allocation of future transponders' capacity.

PT Comunicações
Notes to Financial Statements (Continued)
As at 31 December 2013
(Amounts in Euro)

23. Loans obtained (Continued)

As at 31 December 2013 and 2012, the Company had recorded in the balance sheet the following assets under finance leases:

	2013			2012		
	Gross value	Accumulated depreciation	Carrying value	Gross value	Accumulated depreciation	Carrying value
	Euro					
Tangible fixed assets						
Transport equipment . . .	25,273,664	10,407,145	14,866,519	25,029,846	11,068,954	13,960,892
Other tangible fixed assets	1,699,129	869,412	829,717	1,441,277	467,471	973,806
	<u>26,972,793</u>	<u>11,276,557</u>	<u>15,696,236</u>	<u>26,471,123</u>	<u>11,536,425</u>	<u>14,934,698</u>
Intangible assets						
Industrial property and other rights	52,443,905	43,169,946	9,273,959	51,562,961	35,076,858	16,486,103
	<u>79,416,698</u>	<u>54,446,503</u>	<u>24,970,195</u>	<u>78,034,084</u>	<u>46,613,283</u>	<u>31,420,801</u>

As at 31 December 2013 and 2012, the maturity of minimum lease payments of leasing contracts was as follows:

	2013			2012		
	Capital	Interest	Total	Capital	Interest	Total
	Euro					
Up to 1 year	20,576,337	733,795	21,310,132	19,142,242	1,695,621	20,837,863
Between 1 and 2 years . .	5,592,304	320,728	5,913,032	14,479,139	883,072	15,362,211
Between 2 and 3 years . .	1,910,966	241,731	2,152,697	4,252,715	152,839	4,405,554
Between 3 and 4 years . .	1,725,636	183,241	1,908,877	835,871	63,208	899,079
Between 4 and 5 years . .	876,091	145,655	1,021,746	693,690	22,604	716,294
More than 5 years	1,551,949	25,464	1,577,413	—	—	—
	<u>32,233,283</u>	<u>1,650,614</u>	<u>33,883,897</u>	<u>39,403,657</u>	<u>2,817,344</u>	<u>42,221,001</u>

23.5 Other information

As at 31 December 2013, the Company was party, along with PT SGPS and PT Finance, to one Credit Facilities, with the amount of Euro 800 million, with maturity in June 2016.

As at 31 December 2013, the Company was also part, along with PT SGPS and PT Finance, in an Export Credit Facility, amounting to Euro 180 million, with a maturity in 2023. As at 31 December 2013, the amount used under the Credit Facilities, mentioned above, by PT Finance was Euro 400 million and Euro 70 million, respectively.

As at 31 December 2013, the main covenants included in financing contracts, in relation to which the Company is collectively responsible along with PT SGPS and PT Finance, are as follows and refer to the consolidated accounts:

- **Change in control:** The exchangeable bonds, the credit facilities amounting to Euro 670 million and the loans obtained from the European Investment Bank (“EIB”) totalling Euro 527 million establish penalties in the case of a change in control of PT SGPS. According to the terms and conditions of these debt instruments, a change of control would occur if any person or group of persons acting in concert acquires or controls more than 50 per cent of voting rights, whether obtained by ownership of share capital, the holding of voting rights or pursuant to the terms of a shareholders’ agreement. In certain cases, gaining the power to appoint or remove all, or the majority, of the directors or other equivalent officers of PT SGPS or to give directions with respect to

PT Comunicações
Notes to Financial Statements (Continued)
As at 31 December 2013
(Amounts in Euro)

23. Loans obtained (Continued)

the operating and financial policies of PT SGPS with which the directors or equivalent officers of the company are obliged to comply are also considered a change of control.

The Euro 750 million Eurobond issued in 2009, the Euro 600 million Eurobond issued in 2011, the Euro 750 million Eurobond issued in 2012 and the Euro 1,000 million Eurobonds issued in 2013, establish penalties in the case of any change of control of Portugal Telecom, as described above, only if simultaneously a rating downgrade to sub-investment grade occurs (in case the securities are investment grade securities) or a rating downgrade occurs (in case the securities are sub-investment grade securities) during the Change of Control Period, as defined under the terms and conditions of these notes.

- **Control/disposal of subsidiaries:** Certain revolving credit facilities amounting to Euro 670 million require PT SGPS to, directly or indirectly, maintain majority ownership and control of each material subsidiary. Material subsidiaries are those companies whose total assets are equal or exceed 10% of total consolidated assets or whose total revenues are also equal or exceed 10% of total consolidated revenues.
- **Disposal of assets:** The loans obtained from the EIB totalling Euro 527 million as at 31 December 2013 include certain restrictions regarding the disposal of assets by PT SGPS.
- **Financial ratios:** Certain revolving credit facilities totalling Euro 670 million require that Consolidated Net Debt/EBITDA PT SGPS's ratio does not exceed certain values, which vary depending on each financing.
- **Negative Pledge:** The Euro Medium Term Notes, the exchangeable bonds, the credit facilities, under which Portugal Telecom Group had contracted loans amounting to Euro 670 million, the loans obtained from the EIB and the commercial paper programmes are subject to negative pledge clauses, which restrict the pledge of security interests in the assets of companies included in the consolidation.

The penalties applicable in the event of default in any of these covenants are generally the early payment of the loans obtained or the termination of available credit facilities. As at 31 December 2013, Portugal Telecom and PT Comunicações had fully complied with the covenants mentioned above.

Although current liabilities exceed current assets, the Company is not subject to liquidity risk, because of its ability to obtain needed capital from within the Portugal Telecom Group.

24. Suppliers

The captions "Suppliers" and "Investment suppliers" as at 31 December 2013 and 2012 consist of the following:

	2013	2012
	Euro	
Trade suppliers		
Current	319,470,088	259,336,226
Invoices to be issued	25,651,226	28,605,385
	345,121,314	287,941,611
Investment suppliers		
Current	74,443,261	78,225,664
Invoices to be issued	25,684,107	29,906,857
	100,127,368	108,132,521

PT Comunicações
Notes to Financial Statements (Continued)
As at 31 December 2013
(Amounts in Euro)

25. Accrued expenses

As at 31 December 2013 and 2012, this caption consisted of the following:

	2013	2012
	Euro	
Interest and other financial expenses payable ^(a)	107,973,460	67,038,381
Direct costs of services rendered ^(b)	84,806,581	64,347,556
Charges for vacations, vacation subsidies and other payroll costs . . .	42,964,245	43,592,100
Other supplies and external services	16,132,996	15,159,167
Credits related to invoices issued	10,153,020	8,427,354
Support services ^(c)	8,186,121	38,711,199
Rentals	4,495,887	5,693,006
Maintenance and repairs	3,957,839	2,840,937
Specialized work	3,176,246	2,469,338
Marketing and publicity	2,192,106	2,560,743
Other	9,266,319	17,179,148
	293,304,820	268,018,929

(a) The increase in this caption reflects primarily (i) the loans obtained from PT Portugal, the accrued interest of which increased from Euro 62.1 million as at 31 December 2012 to Euro 86.9 million as at 31 December 2013, (ii) the interest associated with commercial paper programs which increased from Euro 3.4 million as at 31 December 2012 to Euro 18.4 million as at 31 December 2013.

(b) The increase in this caption reflects primarily to amounts billed by the MEO, SA, relating to sales made on behalf of the company, under the provision of converged products and services from fixed and mobile businesses called "M4O", which was launched commercially at the beginning of year 2013.

(c) The decrease in this caption is related primarily with the accrued expenses with PT Communicators Group companies.

26. Services rendered and sales

As at 31 December 2013 and 2012, these captions consisted of the following:

	2013	2012
	Euro	
Services rendered		
Fixed telephone services	517,081,338	560,932,329
Television services	564,564,801	504,959,708
Leased lines and capacity	173,862,385	205,970,299
Internet	121,082,379	131,382,406
Data communications (services)	74,362,602	88,946,049
Publicity	37,167,294	47,073,327
Other	198,131,681	209,906,970
Sales	21,975,806	25,146,653
	1,708,228,286	1,774,317,741

PT Comunicações
Notes to Financial Statements (Continued)
As at 31 December 2013
(Amounts in Euro)

27. Equity in earnings of affiliated companies

As at 31 December 2013 and 2012, this caption consists of the following:

	2013	2012
	Euro	
Gains and losses in affiliated companies		
Gains	202,449,949	120,780,232
Losses	(783,412)	(249,749)
Gains and losses on the disposal of affiliated companies		
Gains ^(a)	32,729,421	—
Losses ^(b)	(521)	—
	<u>234,395,437</u>	<u>120,530,483</u>

(a) In 2013, this caption corresponds to the gain recorded with the disposal of the investment in CTM (Note 20).

(b) In 2013, this caption refers to the loss recorded with the disposal of the investment in PT Brasil (Note 10).

In 2013 and 2012, gains and losses in affiliated companies, resulting from the application of the equity method of accounting (Note 12), were recognized in the following captions:

	2013	2012
	Euro	
Financial investments (Note 10)		
Meo, SA	202,353,668	117,781,679
PT Blue Clip	36,234	(2,198)
Capital Criativo	32,811	3,320
Multicert	24,664	161,282
PT Brasil	127	106
CTM	—	2,833,845
Janela Digital	—	(128,293)
PT Sistemas de Informação	—	(2,191)
Auto Sapo	(3,526)	—
Infonet	(777,439)	(111,957)
	<u>201,666,539</u>	<u>120,535,593</u>
Provision for negative financial investments (Note 22)		
PT Prestações	2,444	(4,286)
PT Sistemas de Informação	(2,446)	(824)
	<u>(2)</u>	<u>(5,110)</u>
	<u>201,666,537</u>	<u>120,530,483</u>

PT Comunicações
Notes to Financial Statements (Continued)
As at 31 December 2013
(Amounts in Euro)

28. Direct costs

For the year ended 31 December 2013 and 2012, this caption consisted of the following:

	<u>2013</u>	<u>2012</u>
	Euro	
Telecommunications costs	318,059,050	313,292,455
Programming costs	127,947,120	122,587,397
Directories	20,672,485	26,422,716
Contents of internet and mobile service	9,364,310	8,892,759
Other	16,129,936	12,849,356
	<u>492,172,901</u>	<u>484,044,683</u>

29. Supplies and external services

For the year ended 31 December 2013 and 2012, this caption consisted of the following:

	<u>2013</u>	<u>2012</u>
	Euro	
Support services	173,456,303	179,003,249
Maintenance and repairs	74,354,917	74,820,724
Commissions	61,380,164	65,991,475
Electricity	32,832,623	33,370,729
Rentals	22,500,926	21,467,867
Specialized work	17,553,741	19,385,996
Communications	13,684,748	14,200,652
Fuel, water and other fluids	7,215,780	7,276,597
Other	28,068,032	29,887,307
	<u>431,047,234</u>	<u>445,404,596</u>

As at 31 December 2013, the Company's obligations under operating lease contracts mature as follows:

	<u>2013</u>
	Euro
Up to 1 year	100,918,198
Between 1 and 2 years	92,711,646
Between 2 and 3 years	1,616,462
Between 3 and 4 years	1,464,969
Between 4 and 5 years	569,775
More than 5 years	2,152,143
	<u>199,433,193</u>

PT Comunicações
Notes to Financial Statements (Continued)
As at 31 December 2013
(Amounts in Euro)

30. Wages and salaries

For the year ended 31 December 2013 and 2012, this caption consisted of the following:

	2013	2012
	Euro	
Salaries	201,499,220	206,325,671
Social Security charges	22,821,971	21,517,595
Social events	2,360,328	3,481,623
Healthcare	2,234,429	1,788,231
Training	1,227,334	1,129,498
Other	1,746,627	1,247,970
	<u>231,889,909</u>	<u>235,490,588</u>

31. Indirect taxes

As at 31 December 2013 and 2012, this caption consists of the following:

	2013	2012
	Euro	
Anacom taxes	10,772,408	11,390,709
Direct taxes	1,286,790	1,411,517
Value Added Tax	528,635	1,036,709
Other	1,597,751	1,559,638
	<u>14,185,584</u>	<u>15,398,573</u>

32. Other income and gains

As at 31 December 2013 and 2012, this caption consists of the following:

	2013	2012
	Euro	
Supplemental income		
Studies, projects and technical assistance	3,229,295	3,755,443
Lease	16,420,759	14,174,671
Other supplemental income ^(a)	68,283,235	94,520,141
Income and gains in non financial investments	4,344,687	2,121,896
Investment subsidies (Note 21.7)	2,150,776	2,997,997
Interest due	1,879,164	2,457,716
Recovery of accounts receivable	1,222,790	837,609
Gains on exchange rate differences	1,123,165	1,293,338
Income from investment properties (Note 7)	620,062	638,953
Other	127,774	1,040,090
	<u>99,401,707</u>	<u>123,837,854</u>

(a) In this caption were recorded a gain of approximately Euro 26 million in 2013 related to a compensation to assign to PT Comunicações by the Portuguese State, following the Concession Agreement revocation related with the universal service (Note 1 (a)) and a gain of approximately Euro 60 million in 2012 related to a net compensation receivable from the Portuguese State for prior years costs supported by PT Comunicações with the universal service obligation under the Concession Agreement.

PT Comunicações
Notes to Financial Statements (Continued)
As at 31 December 2013
(Amounts in Euro)

33. Other expenses and losses

For the year ended 31 December 2013 and 2012, this caption consisted of the following:

	2013	2012
	Euro	
Write-off of tangible fixed assets	6,097,136	11,830,758
Donations	3,290,318	693,260
Losses on exchange rate differences	1,625,855	1,687,604
Contractual penalties incurred	1,625,417	1,463,704
Losses in inventories	1,556,527	2,526,114
Other ^(a)	42,327,010	10,315,064
	<u>56,522,263</u>	<u>28,516,504</u>

(a) This caption includes an impairment loss in amount of Euro 27,964,927 (Note 20), corresponding to the difference between the acquisition value of the investment in Sportinveste Multimédia and its estimated realizable value.

34. Depreciation and amortisation ((losses)/reversals)

For the year ended 31 December 2013 and 2012, this caption consisted of the following:

	2013	2012
	Euro	
Tangible fixed assets (Note 6)	448,603,042	466,841,602
Intangible assets (Note 9)	31,204,987	30,330,408
Investment properties (Note 7)	1,120,137	482,639
	<u>480,928,166</u>	<u>497,654,649</u>

35. Interest and related income/expenses

The detail of these captions in the year ended 31 December 2013 and 2012 were as follows:

	2013	2012
	Euro	
Interest and related income		
Interest income	3,349,339	14,190,982
Gains on exchange rate differences	2,991,516	262,517
Other	576,864	814,413
	<u>6,917,719</u>	<u>15,267,912</u>
Interest and related expenses		
Interest expense	358,573,654	311,664,796
Bank commissions and expenses	5,556,369	3,954,254
Losses on exchange rate differences	4,848,196	288,259
Finance leases	1,319,353	2,730,486
Other	2,748,135	2,369,712
	<u>373,045,707</u>	<u>321,007,507</u>

PT Comunicações
Notes to Financial Statements (Continued)
As at 31 December 2013
(Amounts in Euro)

35. Interest and related income/expenses (Continued)

The detail of interest income and interest expenses in 2013 and 2012 is as follows:

	2013	2012
	Euro	
Interest income		
Intragroup loans ^(a)	3,006,362	14,059,430
Other	342,977	131,552
	<u>3,349,339</u>	<u>14,190,982</u>
Interest expense		
Intragroup loans ^(b)	197,313,572	158,957,483
Other	161,260,082	152,707,313
	<u>358,573,654</u>	<u>311,664,796</u>

(a) The decrease in interest income under this caption results primarily from the full repayment of loans granted to MEO, SA, in the amount of Euro 340,000,000 at 1 March 2013 (Note 12.3).

(b) The increase in this caption reflects mainly a higher level of loans obtained from PT Portugal (Note 23.1).

36. Earnings per share

Earnings per share for the years 2013 and 2012 were computed as follows:

	2013	2012
	restated	
Net income	(210,225,304)	(91,330,314)
Number of shares (Note 21)	1,150,000,000	1,150,000,000
Basic earnings per share	<u>(0.18)</u>	<u>(0.08)</u>

There are no situations that create a dilutive effect, so the diluted earnings per share are the same as basic earnings per share.

PT Comunicações
Notes to Financial Statements (Continued)
As at 31 December 2013
(Amounts in Euro)

37. Guarantees and other financial commitments

As at 31 December 2013 and 2012, the Company had presented guarantees and comfort letters to third parties, as follows:

	2013	2012
	Euro	
Guarantees in favour of courts	1,608,722	1,871,435
Bank guarantees in favor of other entities:		
Highway construction entities	5,734,356	4,325,822
Ministry of Education	3,161,016	3,041,118
Ministry of Justice	7,789,951	2,487,978
Municipalities	2,496,807	5,501,487
CTT	2,007,831	2,007,831
Ministry of Health	1,038,512	1,038,512
Other	6,714,826	4,518,108
	28,943,299	22,920,856
Total guarantees	30,552,021	24,792,291
Commitments of purchase before:		
Fixed asset and content suppliers	19,956,279	34,242,977
Suppliers of inventories	20,398,178	27,768,745
Other services	46,780,174	58,700,454
	87,134,631	120,712,176

Bank guarantees presented to the tax authorities relate primarily to additional income tax assessments for which the Company submitted a claim or an appeal.

Purchase commitments refer to orders placed and not rendered, essentially for the acquisition of materials of infrastructure and telecommunications equipment in the normal course of operations.

38. Events occurred after the balance sheet date

The financial statements for the year ended 31 December 2013 were approved by the Board of Directors and authorized for issuance on 4 February 2014, but are still subject to General Shareholders Meeting approval, under the terms of Portuguese law.

There were no significant events after 31 December 2013 that would require adjustment or disclosure in these financial statements.

39. Note added for translation

These financial statements are a translation of the financial statements originally issued in Portuguese, in accordance with generally accepted accounting principles in Portugal. In case of discrepancies, the original version, in Portuguese, prevails.

Financial Statements

STATUTORY AUDITORS' REPORT

(Translation of a report originally issued in Portuguese—Note 38)

Introduction

1. We have audited the accompanying financial statements of PT Comunicações, S.A. (“the Company”), which comprise the balance sheet as of 31 December 2012 that presents a total of 14,708,347,412 Euros and shareholders’ equity of 5,500,363,405 Euros, including a net loss of 86,901,669 Euros, the statements of income by nature, of changes in shareholders’ equity and of cash flows for the year then ended and the corresponding notes.

Responsibilities

2. The preparation of financial statements that present a true and fair view of the financial position of the Company, the results of its operations, the changes in its shareholders’ equity and its cash flows, as well as the adoption of adequate accounting principles and criteria and the maintenance of an appropriate system of internal control are the responsibility of the Company’s Board of Directors. Our responsibility is to express a professional and independent opinion on these financial statements, based on our audit.

Scope

3. Our audit was performed in accordance with the auditing standards (“*Normas Técnicas e as Diretrizes de Revisão/Auditoria*”) issued by the Portuguese Institute of Statutory Auditors (“*Ordem dos Revisores Oficiais de Contas*”), which require that the audit be planned and performed with the objective of obtaining reasonable assurance about whether the financial statements are free of material misstatement. An audit includes verifying, on a sample basis, evidence supporting the amounts and disclosures in the financial statements and assessing the significant estimates, based on judgements and criteria defined by the Board of Directors, used in their preparation. An audit also includes assessing the adequacy of the accounting principles used and their disclosure, taking into consideration the circumstances, verifying the applicability of the going concern concept and assessing the adequacy of the overall presentation of the financial statements. Our audit also included verifying that the financial information contained in the Managements’ Report is in accordance with the financial statements. We believe that our audit provides a reasonable basis for expressing our opinion.

Opinion

4. In our opinion, the financial statements referred to in paragraph 1 above, present fairly, in all material respects, the financial position of PT Comunicações, S.A. as of 31 December 2012 and the results of its operations, the changes in its shareholders’ equity and its cash flows for the year then ended, in conformity with generally accepted accounting principles in Portugal.

Emphasis

5. The financial statements mentioned in paragraph 1 above refer to the Company on a standalone basis and were prepared in accordance with current legislation for approval and publication. The Company will not prepare consolidated financial statements as, in accordance with number 3 of article 7 of Decree-Law 158/2009, of 13 July 2009 is not required to do so, as its financial statements will be included in the consolidated financial statements of Portugal Telecom, SGPS, S.A.. As described in Note 3.7, although the financial investments have been accounted for by the equity method, under which the Company’s net profit for the year and shareholders’ equity include the effect of consolidating the subsidiary and associated companies, the accompanying financial statements do not include the effects of a full consolidation of their assets, liabilities, revenues and costs.

Report on other legal requirements

6. It is also our opinion that the financial information contained in the Managements' Report is consistent with the financial statements for the year.

Lisbon, 14 March 2013

Deloitte & Associados, SROC S.A.
Represented by João Luís Falua Costa da Silva

PT COMUNICAÇÕES, S.A.
BALANCE SHEETS
31 DECEMBER 2012 AND 2011

	Notes	2012	2011
		Euro	
ASSETS			
Non-current assets			
Tangible fixed assets	6	2,813,701,186	2,906,950,327
Investment properties	7	8,863,837	12,392,304
Goodwill	8	2,982,442,403	2,982,442,403
Intangible assets	9	235,272,678	259,816,598
Financial investments—equity method of accounting	10	7,257,167,784	7,681,339,217
Financial investments—other methods		1,125,252	125,252
Post retirement benefits	11	1,632,840	1,688,553
Shareholders and group companies	12	340,000,000	340,000,000
Other financial assets	14	373,631	2,628,965
Deferred tax assets	15	314,293,512	312,129,716
Total non-current assets		13,954,873,123	14,499,513,335
Current assets			
Inventories	16	48,909,973	54,085,334
Accounts receivable—trade	17	470,155,099	512,113,421
Unbilled revenues	17	64,005,319	121,039,215
Advances to suppliers		8,093,866	6,030,678
State and other public entities	18	193,752	230,428
Shareholders and group companies	12	—	39,993,766
Other accounts receivable	19	117,888,755	44,501,745
Deferrals	13	17,991,662	14,019,807
Non-current assets held for sale	10	5,069,882	—
Cash and bank deposits	4	21,165,981	55,191,387
Total current assets		753,474,289	847,205,781
Total assets		14,708,347,412	15,346,719,116
SHAREHOLDERS' EQUITY			
Share capital	20	1,150,000,000	1,150,000,000
Other shareholders' equity instruments	20	4,350,466,191	4,350,466,191
Legal reserve	20	30,000,000	30,000,000
Other reserves	20	269,718,396	307,033,462
Adjustments to financial assets	20	(456,822,242)	(206,382,607)
Revaluation surplus	20	589,044,034	623,874,447
Other shareholders' equity variations	20	5,524,632	8,522,629
Retained earnings		(350,665,937)	34,725,662
Net (loss) / income		(86,901,669)	(369,353,353)
Total shareholders' equity		5,500,363,405	5,928,886,431
LIABILITIES			
Non-current liabilities			
Provisions	21	297,348	292,057
Loans obtained	22	6,178,861,415	5,223,837,526
Deferrals	13	665,145	1,530,022
Post retirement benefits	11	844,921,754	925,880,233
Deferred tax liabilities	15	173,706,683	184,929,929
Other financial liabilities		135,417	—
Total non-current liabilities		7,198,587,762	6,336,469,767
Current liabilities			
Provisions	21	24,644,235	25,466,773
Loans obtained	22	1,184,254,516	1,985,462,710
Deferrals	13	74,318,913	65,573,712
Accounts payable to group companies	12	1,657,243	—
Suppliers	23	287,941,611	340,332,586
Investment suppliers	23	108,132,521	176,944,027
Accrued expenses	24	268,018,929	401,550,430
Advances from accounts receivable		6,627,708	10,236,291
State and other public entities	18	38,844,553	26,053,311
Other accounts payable	19	14,956,016	49,743,078
Total current liabilities		2,009,396,245	3,081,362,918
Total liabilities		9,207,984,007	9,417,832,685
Total liabilities and shareholders' equity		14,708,347,412	15,346,719,116

The accompanying notes form an integral part of these financial statements.

Accountant

The Board of Directors

PT COMUNICAÇÕES, S.A.
INCOME STATEMENTS
FOR THE YEARS ENDED 31 DECEMBER 2012 AND 2011

	Notes	2012	2011
Euro			
Services rendered	25	1,749,171,088	1,765,074,481
Sales	25	25,146,653	31,683,399
Subsidies to operation		104,184	114,114
Production variation	16	(1,512,527)	(691,549)
Equity in earnings of affiliated companies, net	26	120,530,483	153,266,793
Own work capitalized	6	42,064,039	40,519,680
Costs of products sold	16	(31,638,682)	(38,816,731)
Direct costs	27	(484,044,683)	(413,429,371)
Marketing and publicity		(20,749,856)	(26,220,418)
Supplies and external services	28	(445,404,596)	(473,981,468)
Wages and salaries	29	(235,490,588)	(240,055,639)
Post retirement benefit costs	11	(51,716,640)	(53,879,150)
Curtailment and settlement costs	11	(867,969)	(32,920,244)
Indirect taxes	30	(15,398,573)	(13,779,798)
Impairment of inventories ((losses)/reversals)	16	3,566,877	6,670,382
Impairment of accounts receivable ((losses)/reversals) . .	17, 19	(25,274,422)	(13,702,570)
Provisions (increases/reductions)	21	(8,181,810)	(8,467,556)
Other income and gains	31	123,837,854	51,140,517
Other expenses and losses	32	(28,516,504)	(22,758,849)
INCOME BEFORE DEPRECIATION AND AMORTISATION, FINANCING EXPENSES AND TAXES		<u>715,624,328</u>	<u>709,766,023</u>
Depreciation and amortisation ((losses)/reversals)	33	(497,654,649)	(517,980,453)
OPERATING INCOME (BEFORE FINANCING EXPENSES AND TAXES)		<u>217,969,679</u>	<u>191,785,570</u>
Interest and related income	34	15,267,912	24,486,965
Interest and related expenses	34	(321,007,507)	(323,492,720)
INCOME BEFORE TAXES		<u>(87,769,916)</u>	<u>(107,220,185)</u>
Income taxes	15	868,247	(262,133,168)
NET (LOSS) / INCOME		<u>(86,901,669)</u>	<u>(369,353,353)</u>
Basic earnings per share	35	(0.08)	(0.32)

The accompanying notes form an integral part of these financial statements.

Accountant

The Board of Directors

PT COMUNICAÇÕES, S.A.
STATEMENTS OF CHANGES IN SHAREHOLDERS' EQUITY
FOR THE YEARS ENDED 31 DECEMBER 2011 AND 2012

		Share capital (Note 20.1)	Other shareholders' equity instruments (Note 20.2)	Legal reserve (Note 20.3)	Other reserves (Note 20.4)	Adjustments to financial assets (Note 20.5)	Revaluation surplus (Note 20.6)	sh (N
Euro								
Balance as at 1 January 2011	A	<u>1,150,000,000</u>	<u>5,948,966,191</u>	<u>30,000,000</u>	<u>(338,105,921)</u>	<u>454,706</u>	<u>763,950,232</u>	<u>1</u>
Changes:								
Foreign currency translation adjustments		—	—	—	—	(229,730,525)	—	—
Actuarial losses recognised in the period (Note 11.7)		—	—	—	(71,819,321)	—	—	—
Unpaid dividends		—	—	—	—	23,582,446	—	—
Deferred taxes adjustments (Nota 15.2)		—	—	—	17,954,831	(53,834)	31,541,890	—
Revaluation of tangible fixed assets (Note 6)		—	—	—	—	—	(126,167,563)	—
Realization of revaluation surplus		—	—	—	—	—	(45,450,112)	—
Recognition of investments subsidies		—	—	—	—	—	—	—
Other changes in shareholders' equity		—	—	—	—	(635,400)	—	—
	B	<u>—</u>	<u>—</u>	<u>—</u>	<u>(53,864,490)</u>	<u>(206,837,313)</u>	<u>(140,075,785)</u>	<u>(</u>
Net loss	C							
Comprehensive income	B+C							
Operations with shareholders:								
Application of earnings		—	—	—	—	—	—	—
Share capital increase		1,598,500,000	—	—	—	—	—	—
Devolution of additional paid-in capital contributions		—	(1,598,500,000)	—	—	—	—	—
Reduction of shareholders' equity by incorporation in retained earnings and other reserves		(1,598,500,000)	—	—	699,003,873	—	—	—
	D	<u>—</u>	<u>(1,598,500,000)</u>	<u>—</u>	<u>699,003,873</u>	<u>—</u>	<u>—</u>	<u>(</u>
Balance as at 31 December 2011 E=A+B+C+D		<u>1,150,000,000</u>	<u>4,350,466,191</u>	<u>30,000,000</u>	<u>307,033,462</u>	<u>(206,382,607)</u>	<u>623,874,447</u>	<u>(</u>

PT COMUNICAÇÕES, S.A.
STATEMENTS OF CHANGES IN SHAREHOLDERS' EQUITY (Continued)
FOR THE YEARS ENDED 31 DECEMBER 2011 AND 2012

	Share capital (Note 20.1)	Other shareholders' equity instruments (Note 20.2)	Legal reserve (Note 20.3)	Other reserves (Note 20.4)	Adjustments to financial assets (Note 20.5)	Revaluation surplus (Note 20.6)	Share premium (Note 20.7)
	Euro						
Changes:							
Foreign currency translation adjustments	—	—	—	—	(350,270,498)	—	—
Actuarial losses recognised in the period (Note 11.7)	—	—	—	(49,753,420)	—	—	—
Unpaid dividends	—	—	—	—	50,868,659	—	—
Deferred taxes adjustments (Nota 15.2)	—	—	—	12,438,354	30,434	—	—
Realization of revaluation surplus	—	—	—	—	—	(34,830,413)	—
Recognition of investments subsidies	—	—	—	—	—	—	—
Other changes in shareholders' equity	—	—	—	—	48,931,770	—	—
	F	—	—	(37,315,066)	(250,439,635)	(34,830,413)	(—)
Net loss							G
Comprehensive income							F+G
Operations with shareholders:							
Application of earnings	—	—	—	—	—	—	—
	H	—	—	—	—	—	—
Balance as at 31 December 2012 I = E+F+G+H	1,150,000,000	4,350,466,191	30,000,000	269,718,396	(456,822,242)	589,044,034	(—)

The accompanying notes form an integral part of these financial statements.

Accountant

PT COMUNICAÇÕES, S.A.
STATEMENTS OF CASH FLOWS
FOR THE YEARS ENDED 31 DECEMBER 2012 AND 2011

	Notes	2012	2011
Euro			
OPERATING ACTIVITIES			
Collections from clients		2,404,763,511	2,402,744,802
Payments to suppliers		(1,409,895,617)	(1,318,124,706)
Payments to employees		(206,406,932)	(211,786,410)
Cash flows from operations		788,460,962	872,833,686
Cash receipts (payments) relating to income taxes	4.(a)	35,940,339	(52,218,724)
Payments relating to post retirement benefits	11.5	(186,386,464)	(194,463,921)
Other cash payments, net		(94,253,860)	(47,496,340)
Cash flows from operating activities (1)		543,760,977	578,654,701
INVESTING ACTIVITIES			
Cash receipts resulting from:			
Tangible fixed assets		3,658,939	3,177,083
Financial investments		—	138,970
Loans granted	4.(b)	—	160,000,000
Interest and related income		2,897,304	3,005,350
Dividends	4.(c)	238,273,153	2,390,033
		244,829,396	168,711,436
Payments resulting from:			
Tangible fixed assets		(531,243,187)	(559,676,945)
Intangible assets		(7,758,325)	(10,302,619)
Financial investments	4.(d)	(2,160,372)	(2,275,982)
Loans granted		(600,000)	—
		(541,761,884)	(572,255,546)
Cash flows from investing activities (2)		(296,932,488)	(403,544,110)
FINANCING ACTIVITIES			
Cash receipts resulting from:			
Loans obtained	4.(e)	1,092,000,000	1,231,761,996
Share capital realization	20.1	—	1,598,500,000
Subsidies		1,251,413	114,114
		1,093,251,413	2,830,376,110
Payments resulting from:			
Loans repaid	4.(e)	(947,867,596)	(1,207,274,782)
Interest and related expenses	4.(f)	(426,211,970)	(155,756,690)
Reductions of other equity instruments	20.2	—	(1,598,500,000)
		(1,374,079,566)	(2,961,531,472)
Cash flows from financing activities (3)		(280,828,153)	(131,155,362)
Change in cash and cash equivalents (4)=(1)+(2)+(3)		(33,999,664)	43,955,229
Effect of exchange differences		(25,742)	484,977
Cash and cash equivalents at the beginning of the period		55,191,387	2,918,786
PT Prime Merger		—	7,832,395
Cash and cash equivalents at the end of the period	4.(g)	21,165,981	55,191,387

The accompanying notes form an integral part of these financial statements.

Accountant

The Board of Directors

INDEX

1.	Introduction	F-396
2.	Basis of presentation	F-398
3.	Main accounting policies, judgments and estimates	F-398
4.	Cash flows	F-409
5.	Changes in accounting policies and estimates and errors	F-411
6.	Tangible fixed assets	F-412
7.	Investment properties	F-415
8.	Goodwill	F-415
9.	Intangible assets	F-416
10.	Financial investments—equity method of accounting	F-418
11.	Post-retirement benefits	F-420
12.	Related parties	F-432
13.	Deferrals	F-441
14.	Other financial assets	F-442
15.	Income taxes	F-442
16.	Inventories	F-446
17.	Accounts receivable and unbilled revenues	F-447
18.	State and other public entities	F-448
19.	Other accounts receivable and payable	F-449
20.	Shareholders' equity	F-450
21.	Provisions, contingent liabilities and contingent assets	F-453
22.	Loans obtained	F-457
23.	Suppliers	F-460
24.	Accrued expenses	F-460
25.	Services rendered and sales	F-461
26.	Equity in earnings of affiliated companies	F-461
27.	Direct costs	F-462
28.	Supplies and external services	F-462
29.	Wages and salaries	F-463
30.	Indirect taxes	F-463
31.	Other income and gains	F-463
32.	Other expenses and losses	F-464
33.	Depreciation and amortization ((losses)/reversals)	F-464
34.	Interest and related income/expenses	F-464
35.	Earnings per share	F-465
36.	Guarantees and other financial commitments	F-466
37.	Events occurred after the balance sheet date	F-466
38.	Note added for translation	F-466

PT Comunicações
Notes to Financial Statements
As at 31 December 2012
(Amounts in Euro)

1. Introduction

(a) Development of the company

PT Comunicações, S.A. (“PT Comunicações” or the “Company”) was incorporated in 2000, in accordance with a resolution from the General Meeting of Portugal Telecom, S.A. on April 27, 2000 within the business restructuring process in Portugal Telecom Group and by spin-off from Portugal Telecom, S.A. The conditions for this spin-off were defined under Decree-Law no. 219/00, of September 9, and Joint Order no. 936-A/2000 issued by the Ministers for Social Provision and for Finance on September 14.

On 30 September 2006, under the restructuring process of the Group Portugal Telecom, Portugal Telecom, SGPS, S.A. (“PT SGPS”—Holding company of the Group) sold to PT Portugal, SGPS, S.A. (“PT Portugal”—a sub-Holding company of the Group) all of the shares of PT Comunicações.

On 27 December 2002, PT Comunicações and the Portuguese Government signed the Contract of Purchase and Sale of the Basic Telecommunications Network (“Basic Network”) and the Telex Network, under which the State transferred the full property of the Basic Network and the Telex Network to PT Comunicações, free of any lien or encumbrance. Under the terms of this contract, PT Comunicações is obliged to: i) guarantee the functioning of the Basic Network as an open network, serving as support for the transmission of a general range of services and available to all telecommunications operators and service providers under equal conditions; and ii) provide the acquired network, during the concession period, with the necessary infrastructure for the provision of the concession services and without prejudice to the possibility of its transfer, replacement and/or encumbrance, provided that this does not affect those services.

On 17 February 2003 Decree-Law no. 31/2003 was published, approving the Amendment Agreement to the Concession Contract, which changed the conditions for the concession of public telecommunications services approved by Decree-Law no. 40/95 of February 15. This decree introduced the following fundamental changes to the previous Concession Contract: i) rent payment will no longer be made to the Portuguese State; ii) rights and assets subject to the concession will not revert to the State upon termination; and iii) the State will compensate the Company, under certain compensation mechanisms, for possible negative margins incurred by the Company arising from compliance with the obligations inherent to the provision of the fixed telex, telegraphic and broadcasting services and the mobile marine service.

Under the terms of the above-mentioned Amendment Agreement, the objectives of the concession are: the development and operation of the infrastructure that make up the basic network for telecommunications and signal transmission and emission; the provision of a universal telecommunications service, as defined under Decree-Law no. 458/99, of 5 November; the provision of a telex service; the provision of a data transmission service; the provision of a service for the emission and distribution of telecommunications broadcasts; and the provision of a telegraphic service.

The provision of the universal telecommunications service includes the following: i) connection to the fixed telephone network and access to fixed telephone services; ii) availability of public telephones in public places; and iii) availability of telephone directories and an information service.

The concession period expires in March 2025. As mentioned above, both the Amendment Agreement to the Concession Contract and the Portuguese Law impose certain obligations to PT Comunicações as a universal service provider. On February 2012, following a public hearing about the selection of the universal service provider, Anacom issued a final decision splitting the universal service into three functions: (1) connection to a public communications network in a fixed location and rendering of a telephone service through this network (Tender 1); (2) public phones offer (Tender 2); and (3) make available a complete telephone list and a related service (Tender 3). In 2012, the Portuguese State launched a public tender to select the universal service providers, approved the definition of the universal service cost and established a compensation fund for the universal service providers.

PT Comunicações
Notes to Financial Statements (Continued)
As at 31 December 2012
(Amounts in Euro)

1. Introduction (Continued)

PT Comunicações is qualified to receive compensation from the fund established by Anacom to cover the costs incurred up to date with the universal service.

On 11 February 2004, Law 5/2004 or the “Electronic Communications Act” was published, which establishes the legal regime applicable to electronic communications networks and services, and to the associated resources and services, and defines the authority of the national regulatory agency in this area.

On 9 December 2008, ANACOM attributed to PT Comunicações the rights to the use frequencies, on a national basis, to provide digital television services (TDT) for the broadcasting television programs with unconditional access (also known as public access channels) which is associated with Multiplexer A (Mux A). During the year 2011, ANACOM defined the obligations associated with such rights, and as a result PT Comunicações recognized an intangible asset corresponding to the present value of the commitments under such rights (Note 9).

(b) Corporate transactions

During 2007, PT Comunicações acquired the shares of PT Prime—Enterprise Solutions and Telecommunication Systems, SA (“PT Prime”), PT Corporate—Enterprise Solutions for Telecommunications and Information Systems, SA (“PT Corporate”) and PT.Com—Interactive Communications, SA (“PT.COM”), previously held by PT SGPS, seeking to consolidate all fixed line services into PT Comunicações.

In March 2008, PT.Com and PT Corporate were merged through their incorporation into PT Comunicações and, consequently, the equity, rights and obligations of those companies were transferred to PT Comunicações, and PT.Com and PT Corporate ceased to exist as separate entities.

In July 2009, PT Comunicações acquired from Novabase—Sociedade Gestora de Participações Sociais, SGPS, S.A. (“Novabase”) a 36.25% stake in Superemprego—Sistemas de Informação para a Gestão de Recursos Humanos, S.A. (“Superemprego”), and therefore Superemprego became fully owned by Portugal Telecom Group. In November 2009, Superemprego was merged through its incorporation into PT Comunicações and, consequently, its equity, rights and obligations were transferred to PT Comunicações and Superemprego was ceased to exist as a separate entity.

On 30 November 2010, and considering the need to adjust the corporate structure to reflect the consolidation of its fixed-line and mobile business, PT Comunicações acquired from PT Portugal the full stake in TMN—Telecomunicações Móveis Nacionais, S.A. (“TMN”).

On 29 December 2011, PT Prime was merged into PT Comunicações through the incorporation of its shareholders’ equity and rights and obligations. For accounting purposes, this merger was reported as of 1 January 2011 and, accordingly, all transactions made by PT Prime as from that date were made on behalf of PT Comunicações.

On 3 May 2012, PT Comunicações concluded the acquisition from TVI—Televisão Independente, S.A. (“TVI”) of its former wholly-owned subsidiary RETI—Rede Teledifusora Independente, S.A. (“RETI”), which therefore became a wholly-owned subsidiary of PT Comunicações (Notes 4 and 10). On 12 December 2012, RETI was merged into PT Comunicações through the incorporation of its shareholders’ equity and rights and obligations. For accounting purposes, this merger was reported as of 3 May 2012 and, accordingly, all transactions made by RETI as from that date were made on behalf of PT Comunicações.

(c) Other information

Under the terms of article 7 of Decree-Law no. 158/2009, despite holding financial stakes in group companies and associates, the Company is not required to prepare consolidated financial statements,

PT Comunicações
Notes to Financial Statements (Continued)
As at 31 December 2012
(Amounts in Euro)

1. Introduction (Continued)

given that it is indirectly fully held by PT SGPS, which already presents consolidated financial statements which include the financial statements of the Company and its affiliated companies.

2. Basis of presentation

These financial statements were prepared in accordance with Portuguese legislation, based on Decree-law n.º. 158/2009, which approved the new Portuguese accounting system, named Sistema de Normalização Contabilística (“SNC”), including the conceptual structure, Normas Contabilísticas e de Relato Financeiro (“NCRF”) and Interpretative Standards, as approved by Notices n.º 15652/2009, 15655/2009 and 15653/2009, respectively.

The Company adopted NCRF for the first time in 2010 and applied for this purpose the “*NCRF 3 First Time Adoption Of NCRF*” (“NCRF 3”), with the transition date being 1 January 2009 for the purposes of the presentation of these financial statements. Previously, the Company’s financial statements were prepared in accordance with accounting standards as previously in effect in Portugal (Plano Oficial de Contabilidade—“POC”) and other complementary legislation, which were modified by SNC. The conversion adjustments made to the financial statements as at 1 January 2009 were computed retrospectively, as determined by NCRF 3.

As permitted by Decree-Law n.º. 158/2009, the Company also applies the International Financial Reporting Standards (“IAS/IFRS”) and related interpretations (“SIC/IFRIC”) issued by International Accounting Standards Board (IASB), in order to fill in the gaps or omissions in SNC regarding specific situations of certain transactions.

3. Main accounting policies, judgments and estimates

These financial statements were prepared assuming the continuity of operations. The main accounting policies used in the preparation of these financial statements are described below and were applied consistently, unless indicated otherwise.

3.1. Tangible fixed assets

Tangible fixed assets other than land and buildings and ducts infrastructure are stated at acquisition or production cost, which includes the purchase price and any expenses directly attributable to bringing the asset to the location and making them operational.

Land, buildings and the ducts infrastructure are presented in accordance with the revaluation model based on regular assessments, at least tri-annually, deducted from subsequent depreciation for buildings and infrastructure. The fair value of real estate properties is determined by external appraisers based on market prices or the income obtained by these assets, under the provisions of NCRF 7 Tangible Fixed Assets. Regarding the ducts infra-structure, the Company, has applied IAS/IFRS by assessing the fair value of these assets based on the depreciated replacement cost method, as this methodology is not provided under NCRF 7. The Company maintained these assets recognized at the revaluation model, although the valuation methodology is not provided under NCRF 7, in order to ensure the consistency with Portugal Telecom’s consolidated financial statements regarding the valuation of this type of asset, through the application of IAS/IFRS.

Subsequent expenses are included in the asset’s carrying amount only when it is probable that future economic benefits flow to the Company and the cost can be measured reliably. The costs of maintenance and repair that are not likely to generate future economic benefits are recognized as an expense in the period they are incurred.

Increases resulting from revaluations are recorded in equity under the caption “Revaluation surplus”, except for increases that reverse a decline previously recognized in earnings. Decreases resulting from

PT Comunicações
Notes to Financial Statements (Continued)
As at 31 December 2012
(Amounts in Euro)

3. Main accounting policies, judgments and estimates (Continued)

revaluations are recorded directly under the caption “Revaluation surplus” up to the credit balance of the revaluation surplus for the relevant asset. Any excess in relation to the relevant credit balance is recognized in earnings. When the revalued asset is written off, the revaluation surplus included in equity regarding the asset is not reclassified to net income and is instead transferred to retained earnings. Annually, the revaluation surpluses are transferred to retained earnings in the same proportion of their depreciation.

With the exception of lands that are not depreciated, the depreciation of other tangible fixed assets is recognized, from the month in which the asset is available for use, on a straight-line basis over the useful life of asset, which is determined according to expected utility. The amortization period of tangible assets is reviewed on an annual basis and adjusted in order to reflect the estimated useful lives. The annual rates applied reflect the estimated useful life for each class of assets, as follows:

<u>Asset Class</u>	<u>Years of useful life</u>
Buildings and other constructions	3 - 50
Basic equipment	
Network installations and equipment	7 - 40
Ducts infra-structure	40
Telephones, switchboards and other	4 - 10
Submarine cables	15 - 20
Other basic equipment	4 - 20
Transportation equipment	4 - 8
Administrative equipment	3 - 10
Other tangible fixed assets	4 - 8

Following the approval of the Amendment Agreement to the Concession Contract, concluded in 2003 in connection with the acquisition of the Basic Network from the Portuguese Government, which now provides that the fixed assets related to the concessions will no longer be returned to the Portuguese State after the concession, the Company revised the amortization period of the assets which previously had useful lives that exceeded the term of the Concession Contract.

The useful lives and depreciation methods are reviewed annually, and the effect of any changes to these estimates is recognized prospectively in the income statement.

Gains or losses arising from the write-off or disposal of tangible fixed assets are determined as the difference between the amount received and the net recorded amount of the asset, and are recognized in the income statement.

3.2. Leases

Leases are classified as finance leases whenever the terms of the lease transfer substantially all the risks and rewards of ownership to the lessee. The remaining lease contracts are considered operating leases. The classification of leases depends on the substance of the transaction and not on the form of the contract.

Assets acquired under finance leases and the corresponding liabilities are accounted at the beginning of the contract as the lesser amount between the fair value of the assets and the present value of minimum lease payments. Rents include interest and capital amortisation, with the first being recognized in the income statement in the related period.

Under operating leases, rents are recognized on a straight-line basis during the period of the lease.

PT Comunicações
Notes to Financial Statements (Continued)
As at 31 December 2012
(Amounts in Euro)

3. Main accounting policies, judgments and estimates (Continued)

3.3. Investment properties

Investment properties includes mainly buildings and land held to earn rent and/or capital appreciation and not for use in the normal course of the business.

Investment properties are stated at acquisition cost plus transaction expenses and reduced by accumulated depreciation and accumulated impairment losses, if any. Expenditures incurred (maintenance, repairs, insurance and real estate taxes) and income and rents obtained are recognized in the income statement of the period.

Investment properties are depreciated on a straight-line basis, during their expected useful lives. Generally depreciation rates correspond to the respective estimated useful lives (Note 3.1).

3.4. Business combinations and goodwill

Acquisitions of subsidiaries are recorded based on the purchase method (NCRF 14). The purchase price includes, on the acquisition date, the following components: (a) the fair value of assets acquired; (b) the fair value of liabilities incurred; (c) the fair value of equity instruments issued by the Company in exchange for the control of the subsidiary; and (d) expenses directly attributable to the acquisition. When applicable, the purchase price includes the effect of contingent payments agreed under the transaction, with subsequent changes in those payments being recorded as an adjustment to goodwill.

Any excess of the acquisition cost over the fair value of net assets acquired and contingent liabilities of the acquired company at the date of acquisition is recorded as goodwill, in accordance with NCRF 14. If the acquisition cost is lower than the fair value of identifiable net assets, the difference is recorded as a gain in the net income. As provided for in NCRF 3, the Company will apply NCRF 14 only to acquisitions after 1 January 2009 and accordingly goodwill related to acquisitions prior to that date were maintained as initially computed under POC.

Goodwill resulting from the acquisition of subsidiaries is included in the balance sheet under the caption "Goodwill".

Goodwill is not amortised, but tested, on an annual basis or whenever there is evidence of a potential loss of value, for impairment losses. For impairment test purposes, goodwill is allocated to cash generating units. Any impairment loss is recognized in the income statement of the period, and cannot be reversed in a subsequent period.

3.5. Intangible assets

Intangible assets include mainly (1) the amount for the acquisition of the Basic Network, (2) software licenses, (3) TDT license acquisition cost and (4) satellite capacity rights. Intangible assets acquired separately are recorded at cost net of accumulated amortisation and accumulated impairment losses, if any.

Intangible assets are amortised on a straight-line basis and over a period of three years, except: (a) the value of the acquisition of the property of the Basic Network, which is amortised over the remaining period until the end of the concession (2025), (b) the value of the commitments assumed under the of TDT license, which is amortized until the end of the first renewal period of the same (2038); and (c) the satellite capacity rights, which are amortised over the period of their respective contracts. The useful lives and depreciation method of the intangible assets are reviewed annually, and the effect of any changes to these estimates is recognized prospectively in the income statement.

Expenses with research activities are recognized in earnings when incurred. Development expenses are capitalized when it is demonstrated the technical and economic feasibility of the product, and the

PT Comunicações
Notes to Financial Statements (Continued)
As at 31 December 2012
(Amounts in Euro)

3. Main accounting policies, judgments and estimates (Continued)

Company has the intention and ability to complete its development and starts its commercialization or use, as provided in the “NCRF 6 Intangible Assets”.

3.6. Impairment of tangible and intangible assets

The Company performs impairment tests for its tangible and intangible assets if any event or change results in an indication of impairment. In case of any such indication, the recoverable amount of the asset is estimated in order to determine the extent of the impairment loss. When it is not possible to determine the recoverable amount of an individual asset, the estimated recoverable amount of the cash-generating unit to which the asset belongs is used.

The recoverable amount is the greater of fair value less cost to sell and the value in use. The net selling price is the amount that could be received from a transaction between independent parties, reduced by direct costs related to the sale. In assessing the value in use, the estimated future cash flows are discounted to their present value using a discount rate that reflects current market assessments of the time value of money and the specific risk to the asset.

If the recoverable amount of an asset is estimated to be less than its carrying amount, an impairment loss is recognized in the income statement.

3.7. Financial investments

Subsidiaries are those entities over which the Company has the power to govern the financial and operating policies generally represented by the majority of the voting rights. Associated companies are entities over which the Company has significant influence but does not control, generally represented by stakes between 20% and 50% of voting rights.

Financial investments in subsidiaries and associated companies are recorded under the equity method of accounting. Under this method, financial investments are initially recorded at acquisition cost and subsequently adjusted for the changes, after the acquisition date, in the Company’s share in the net assets of those entities. The entity’s earnings include its share in the earnings of those companies.

Under the application of the equity method of accounting, adjustments are made to the financial statements of affiliated companies in order to (1) conform their accounting policies with those adopted by the Company, (2) reflect the impacts of purchase price allocation processes and, (3) eliminate gains and losses resulting from transactions between affiliated companies of PT Comunicações.

Financial investments in foreign entities are translated to Euros using the exchange rates prevailing at the balance sheet date, while the Company’s share in the earnings of those entities is computed based on the average exchange rates for the reported period. The effect of translation differences is recognized in shareholders’ equity under the caption “Adjustments in financial assets”.

The exchange rates used in the translation of the main financial statements of the foreign entities are as follows:

<u>Currency</u>	<u>2012</u>		<u>2011</u>	
	<u>Closing</u>	<u>Average</u>	<u>Closing</u>	<u>Average</u>
Macao Pataca	10.5328	10.2624	10.3525	11.1619
Brazilian Real	2.7036	2.5084	2.4159	2.3265

Financial investments are evaluated whenever there is evidence that it might be impaired, with impairment losses being recorded in the income statement.

PT Comunicações
Notes to Financial Statements (Continued)
As at 31 December 2012
(Amounts in Euro)

3. Main accounting policies, judgments and estimates (Continued)

3.8. Post-retirement benefits

(a) Post-retirement pensions

The Company has the obligation to pay to a group of employees a pension supplement. In order to finance these obligations, various funds were incorporated by PT Comunicações (Note 11.1).

In order to estimate the amount of the Company's liabilities under these pension plans, the Company obtains periodically actuarial valuations, using the "Projected Unit Credit Method". As mentioned above, according to "NCRF 28—Employee Benefits" and "IAS 19—Employee Benefits", PT Comunicações has decided to adopt the alternative treatment referred in IAS 19 for recognition of actuarial gains and losses directly in equity, namely those resulting from changes in actuarial assumptions and from differences between actual data and actuarial assumptions.

Plan amendments related to reduction or increase of the benefits granted to employees are recorded as prior years' service gains or losses. Prior years' service gains or losses related to vested rights are recognized under the caption "Costs with post-retirement benefits" when they occur. Those related to unvested rights are recognized on a straight-line basis until they become vested (generally corresponding to the retirement date). Gains obtained with the settlement of any plan are recognized when incurred under the caption "Curtailement and settlement costs".

Liabilities stated in the balance sheet correspond to the difference between the Projected Benefit Obligation ("PBO") related to pensions deducted from the fair value of pension fund assets and any prior years' service gains or losses not yet recognized.

Contributions made by the Company to defined contribution pension plans are recognized in net income when incurred.

(b) Health care benefits

Under a defined benefit plan, PT Comunicações is responsible to pay, after the retirement date, health care expenses to a group of employees and relatives. This health care plan is managed by Portugal Telecom—Associação de Cuidados de Saúde ("PT-ACS"). In 2004, the Group established PT Prestações—Mandatária de Aquisições e Gestão de Bens, SA ("PT Prestações") to manage an autonomous fund to finance these obligations (Note 11.2).

The amount of the Company's liabilities with respect to these benefits after the respective retirement date is estimated based on actuarial valuations, using the "Projected Unit Credit Method". As mentioned above, the Company recognises actuarial gains and losses directly in equity, namely those resulting from changes in actuarial assumptions and from differences between actual data and actuarial assumptions.

Plan amendments related to reduction or increase of the benefits granted to employees are recorded as prior years' service gains or losses. Prior years' service gains or losses related to vested rights are recognized under the caption "Post-retirement benefit costs" when they occur and those related to unvested rights are recognized on a straight-line basis until they become vested, which usually corresponds to the retirement date. Gains obtained with the settlement of any plan are recognized when incurred under the caption "Curtailement and settlement costs".

Accrued post-retirement health care liabilities stated in the Balance sheet correspond to the present value of obligations from defined benefit plans, deducted from the fair value of fund assets and any prior years' service gains or losses not yet recognized.

PT Comunicações
Notes to Financial Statements (Continued)
As at 31 December 2012
(Amounts in Euro)

3. Main accounting policies, judgments and estimates (Continued)

(c) Pre-retired and suspended employees

In connection with the programs related to employees that are under a suspended contract agreement or that have been pre-retired, the Company recognises a liability in the balance sheet equivalent to the present value of salaries payable up to the retirement age. The related cost is recorded in the income statement under the caption "Curtailement and settlement costs" (Note 11.3).

3.9. Accruals and deferrals

The Company records its revenue and expenses as they are generated or incurred, regardless of when they are received or paid, respectively.

3.10. Income taxes

Income tax expense corresponds to the sum of current and deferred taxes. Deferred taxes are recognized in the income statement except when they relate to items recorded directly in shareholders' equity and accordingly are also recorded in shareholders' equity.

Current taxes are computed based on the taxable income of the period computed under the Corporate Income Tax ("IRC").

Portugal Telecom adopted the special taxation regime for Groups of companies, in which PT Comunicações is included. Consequently, the income tax due, net of withholding taxes and payments on accounts are recorded on the balance sheet as accounts payable or receivable from Portugal Telecom.

The income tax recorded in the financial statements was assessed in accordance with the terms of "NCRF 25 Income Taxes". In assessing the cost of income tax for the year, besides the current tax determined on the basis of profit before-tax adjusted in accordance with the tax legislation, we also consider the effects resulting from temporary differences between the carrying value of assets and liabilities and the related tax amounts. Deferred tax assets and liabilities are computed and analysed annually, based on the expected tax rate that will be effective on the date on which such temporary differences are no longer applicable.

Deferred tax assets are recorded only when there is a reasonable expectation of sufficient future tax profits. As at the balance sheet date the Company conducts a reassessment of the above-mentioned temporary differences with respect to the deferred tax assets, in order to record deferred tax assets that were not recognized previously because they had not met the necessary conditions for their recognition, and/or reduce the amount of deferred tax assets which are recognized based on the current estimate of their future recoverable amounts.

3.11. Inventories

Inventories are stated at average acquisition cost. Adjustments to the carrying value of inventories are recognized based on technological obsolescence or low rotation.

Work in progress relating to installation of telecommunication equipments for clients is valued at production cost, which mainly includes expenses on equipment and various materials used, as well as wages and salaries related to the project.

Impairment losses on inventories includes the value of materials for which there is no intended use due to obsolescence and/or low rotation, as well as the difference between prices of materials that have a fair value lower than the average acquisition cost, when the difference is higher than the discount granted in current market conditions. Impairment losses and related reversals are recorded in earnings primarily under the caption "Impairment of inventories ((losses)/reversals)".

PT Comunicações
Notes to Financial Statements (Continued)
As at 31 December 2012
(Amounts in Euro)

3. Main accounting policies, judgments and estimates (Continued)

3.12. Trade receivables and other

Trade receivables and other receivables are initially recognized at fair value and subsequently measured at cost or amortised cost, based on the effective interest method, deducted from impairment losses.

Impairment losses for doubtful accounts receivable are computed based on the evaluation of estimated risks resulting from the non-collection of receivables, and are recognized in the income statement of the period in which they are calculated.

3.13. Subsidies

Subsidies are only recognized when they are received and after reasonable assurance that the Company will comply with their respective requirements for their assignment.

Subsidies associated with the acquisition or production of non-current assets (investment subsidies) are initially recognized in equity under the caption "Other shareholders' equity", and subsequently allocated on a straight-line basis as income for the year, during the useful lives of the assets to which they relate.

Operating subsidies are recognized in the income statement on a constant basis over the periods in which expenses that they intended to compensate are recognized.

3.14. Provisions and contingent liabilities

Provisions are recognized when (i) there is a present obligation as a result of a past event, (ii) it is probable that an outflow of resources embodying economic benefits will be required to settle the obligation and (iii) a reliable estimate can be made of the amount of the obligation. Where any of the above-mentioned criteria is not met, the Company discloses the event as a contingent liability, unless the chance of cash outflow is remote.

Provisions are recognized for an amount corresponding to the present value of the best available estimate, at the reporting date, of the resources required to settle the obligation. That estimate is determined considering the risks and uncertainties associated with the obligation. Provisions are reviewed at the end of each year and adjusted in order to reflect the best available estimate as of that date.

The present obligations arising from onerous contracts (in which the cost of meeting the obligations under the contract exceed the economic benefits expected thereunder) are calculated and recorded as provisions.

3.15. Loans obtained

Loans obtained are initially recognized at fair value, net of transaction costs incurred, and subsequently presented at amortised cost, based on the effective interest method.

3.16. Borrowing costs

The Company has the policy of capitalizing of borrowing costs related to loans obtained to finance the acquisition, construction or production of tangible assets. However, the Company has recognized borrowing costs as expenses when incurred, since the construction period of tangible assets is usually short.

3.17. Vacation pay and vacation subsidies

Vacation pay and vacation subsidies and related social charges are recorded as a cost for the period in which the employee acquires the right to receive them. Consequently, the amount of vacation pay and

PT Comunicações
Notes to Financial Statements (Continued)
As at 31 December 2012
(Amounts in Euro)

3. Main accounting policies, judgments and estimates (Continued)

subsidies and related social charges due and unpaid at the balance sheet date are estimated and included under the caption “Accrued expenses”.

3.18. Balance classification

Realizable assets and liabilities under which the Company has an unconditional right to defer its settlement for a period over one year from the balance sheet date are classified under non-current assets and non-current liabilities, respectively, at present value.

3.19. Foreign currency transactions and balances

Transactions denominated in foreign currencies (different from the domestic currency of the Company) are recorded at the exchange rates prevailing at the time the transactions are made. Assets and liabilities in foreign currency for which there is no agreement for fixing an exchange rate are translated to Euros using the exchange rates prevailing at the balance sheet date. Gains or losses arising from the differences between exchange rates in force at the date of the respective transactions and those applying on the date of collection, payment or balance sheet date are recorded as income and losses, respectively, in the income statement.

Assets and liabilities as at 31 December 2012 and 2011 were translated to Euro using the following exchange rates reported by the Bank of Portugal:

<u>Currency</u>	<u>2012</u>	<u>2011</u>
Special Drawing Rights	1.1658	1.1865
American dollar	1.3194	1.2939
Namibian dollar	11.1727	10.4830
Cape Verde escudo	110.2650	110.2650
Swiss franc	1.2072	1.2156
Angolan Kwanza	126.8460	133.9285
British pound	0.8161	0.8353
Mozambique metical	39.2400	34.9600
Brazilian real	2.7036	2.4159

3.20. Revenue recognition

Revenue is measured at fair value of the amount received or receivable. Revenue recognition is deducted from the estimated amount of returns, discounts and other rebates and does not include the Value Added Tax (VAT) and other taxes paid related to the sale.

Revenue from the services rendered is recognized by reference to the stage of completion of the transaction at the reporting date, if all the following conditions are met: (1) the revenue amount can be reliably measured; (2) it is probable that future economic benefits associated with the transaction will flow to the Company; (3) the expenses incurred or to be incurred with the transaction can be measured reliably; and (4) the stage of completion of the transaction at the reporting date can be reasonably estimated.

(a) National fixed national communications

Revenues from telecommunication activities are recognized at their gross amounts when services are rendered. Billings for these services are made on a monthly basis throughout the month. Amounts not yet invoiced but already due or incurred are recorded based on estimates and included under the caption “Unbilled revenues”. Differences between accrued amounts and the actual unbilled revenues are recognized in the following period.

PT Comunicações
Notes to Financial Statements (Continued)
As at 31 December 2012
(Amounts in Euro)

3. Main accounting policies, judgments and estimates (Continued)

(b) International fixed communications

The income from international telecommunication services are calculated according to fixed termination rates under bilateral agreements with several telecom operators. These agreements also establish whether it is the operator of the sending network that must submit the credit to the operator of the receiving network or whether the operator of the network receiving must provide the debit first.

(c) Internet Protocol Television (“IPTV”) and Direct to Home (“DTH”) services

The income from the television service through Internet Protocol Television (IPTV) and satellite are recognized as follows: (i) the amounts charged for monthly subscription of services used are recognized in the period in which the service is rendered; (ii) equipment rental is recognized over the lease period; (iii) equipment sales are recognized upon sale; and (iv) penalties imposed to customers are recognized when received.

(d) Internet services

Revenues from ISP services result essentially from monthly subscription fees and telephone traffic when the service is used by customers. These revenues are recognized when the service is rendered.

(e) Advertising services

Advertising revenues from telephone directories and related costs are recognized in the period in which the directories are effective. PT Comunicações has a contract with Páginas Amarelas whereby the latter is responsible for production, publishing and distribution of PT Comunicações’ telephone directories, as well as for selling advertising space in the directories. The total cost to be paid by PT Comunicações for such services is set at a fixed 78% of its gross revenues from the sale of advertising space in telephone directories. The prices of advertising space are fixed, not contingent, and based on the expected volume of the distributed directories (approximately one to every telephone number). Revenues from the sale of advertising space are invoiced directly by PT Comunicações to its corporate clients during the one-year advertising period. These revenues are recognized in earnings on a monthly basis during the period for the respective directory.

(f) Leased lines and rental of ducts and capacity

Income from leased lines is recorded as operating leases in the respective period, under the caption “Services rendered”.

(g) Interest

Interest revenue is recognized based on the effective interest method.

Income relative to advance payments made by customers are deferred and recognized when the service is rendered.

3.21. Own work capitalized

Internal expenses incurred by the Company in the construction of fixed assets, which correspond to materials, work force and transportation, at cost, are capitalized under the caption “Own work capitalized”, only when the following requirements are met: (a) the tangible assets are identifiable; (b) the tangible assets will generate future economic benefits; and (c) development expenses can be reliably measured.

PT Comunicações
Notes to Financial Statements (Continued)
As at 31 December 2012
(Amounts in Euro)

3. Main accounting policies, judgments and estimates (Continued)

3.22. Losses and gains recognised under projects

The Company records losses and gains associated with projects based on their stage of completion. Accordingly, invoices issued related to work not yet performed are recorded under the caption “Deferrals”, unbilled revenues related to work in progress are recorded under the caption “Unbilled revenues” and expenses related to unbilled performed work are recorded as work in progress under the caption “Inventories”.

3.23. Financial assets and liabilities

Financial assets and liabilities are recognized in the balance sheet when the Company becomes party to the corresponding contractual terms, and are classified at cost or amortised cost.

(a) Financial assets and liabilities at cost or amortised cost

Assets and liabilities are classified at cost or amortised cost if they present the following characteristics: (a) have a defined maturity; (b) have a fixed or determined income; and (c) do not represent a derivative financial instrument or do not include a derivative financial instrument.

Assets and liabilities classified in this category are measured at amortised cost reduced by accumulated impairment losses (for financial assets) and correspond primarily to the following asset and liability captions included in the Company’s balance sheet:

- Accounts payable to Group companies
- Accounts receivable—trade
- Unbilled revenues and accrued expenses
- Advances to suppliers and from accounts receivable
- State and other public entities
- Other accounts receivable and payable
- Other financial assets and liabilities
- Cash and bank deposits
- Loans obtained
- Suppliers and investments suppliers

Amortized cost is determined through the effective interest method. The effective interest rate is the one that discounts the estimated future payments and receipts until the term of the financial instrument to the carrying value of the financial asset or liability.

(b) Impairments on financial assets

Financial assets included under the caption “cost or amortised cost” are subject to impairment tests at each year end. Such assets are impaired when there is clear evidence that, as a result of one or more events occurred after its initial recognition, their future estimated cash flows will be affected.

For assets measured at amortised cost, the impairment loss corresponds to the difference between the carrying amount of the asset and the present value of the revised future estimated cash flows discounted using the initial effective interest rate. For financial assets measured at cost, the impairment loss corresponds to the difference between the carrying amount of the asset and the best available estimate of the asset’s fair value.

PT Comunicações
Notes to Financial Statements (Continued)
As at 31 December 2012
(Amounts in Euro)

3. Main accounting policies, judgments and estimates (Continued)

Subsequently, if there is a reduction in the impairment loss as a result of an event occurring after the initial recognition of the loss, the impairment should be reversed through earnings. The reversal is recognized up to the amount that would be recorded if the loss had not been initially recognized.

Impairment losses and related reversals are recorded in earnings mainly under the captions "Impairment of accounts receivable ((losses)/reversals)".

(c) Derecognition of financial assets and liabilities

The Company derecognizes financial assets when its contractual rights to obtain the asset's cash flows expire, or when it transfers to another entity all the significant risks and rewards associated with the ownership of such assets. We also derecognize financial assets transferred in respect to which the Company has retained some significant risks and benefits, in the case that control over them has been assigned. The Company derecognizes financial liabilities only when the corresponding obligation is settled, cancelled or expired.

3.24. Main accounting estimates and judgements

To prepare the standalone financial statements under NCRF, the Company's Board of Directors uses estimates and assumptions that affect in the application of accounting policies and the amounts reported. Estimates and judgements are continually evaluated and are based on historical experience and on other factors including expectations of future events that are believed to be reasonable under the circumstances on which the estimate was based, or as a result of new information or more experience.

The most significant accounting estimates reflected in the financial statements are the following:

(i) Post-employment benefits

The present value of liabilities for post-employment benefits is calculated based on actuarial methodologies, which use certain actuarial assumptions that are reviewed annually by the Company. Any change in these assumptions will impact the carrying value of liabilities. The main assumptions used are described in Note 11.

(ii) Analysis of goodwill impairment

The Company tests annually whether goodwill has suffered any impairment. The recoverable amounts of cash-generating assets are determined based on value-in-use calculations. The use of this method requires the estimate of future cash flows expected to arise from the continuing operation of the cash generating asset, the choice of a growth rate to extrapolate cash flow projections and the estimate of a suitable discount rate for each cash generating asset. The main assumptions used in the goodwill analysis are disclosed in Note 8.

(iii) Useful life of tangible fixed assets

The Company used estimates in order to determine to the useful life of tangible fixed assets.

(iv) Provisions recognition

The Company is party to several legal proceedings in progress for which, based on the opinion of its lawyers, judgments are made to determine the recognition of any necessary provisions to meet these contingencies.

PT Comunicações
Notes to Financial Statements (Continued)
As at 31 December 2012
(Amounts in Euro)

3. Main accounting policies, judgments and estimates (Continued)

(v) Impairment recognition

Impairment on accounts receivable are calculated mainly based on receivables seniority, the clients risk profile and their financial situation.

(vi) Determining the fair value of assets measured by revaluation model

The Company uses the revaluation model to measure the book value of the asset classes “Land and natural resources”, “Buildings and other constructions” and the “Telecommunication infrastructure” included under the caption “Basic equipment” under tangible fixed assets. In order to assess the fair value of real estate properties included under the assets classes “Land and natural resources” and “Buildings and other constructions”, the Company uses external appraisers to determine their value based on certain specific indicators related to the real estate market. In order to assess the revalued amount of the asset class “Telecommunication infrastructure”, the Company applied the cost replacement method based on current and observable prices of materials and construction work related to the installation underground of the telecommunication infrastructure.

(vii) Purchase price allocation of the investment in TMN

In connection with the acquisition of TMN completed on 30 November 2010, the Company completed in 2011 the purchase price allocation of this investment. For that purpose, certain intangible assets of TMN were adjusted to fair value, based on a valuation methodology that required the estimate of future cash flows resulting from the operations of this affiliated company, the choice of a growth rate to extrapolate cash flow projections beyond the time horizon covered and the definition of a suitable discount rate to compute the present value of those cash flows.

Estimates used are based on the best information available during the preparation of financial statements, although future events, neither controlled nor foreseeable by the Company, could occur and have an impact on those estimates. In accordance with “NCRF 4 Accounting Policies, Changes in Estimates and Errors” (“NCRF 4”), changes to these estimates that occur after the date of the financial statements are recognized in net income, using a prospective methodology. For this reason and given the degree of uncertainty, real results of the transactions in question may differ from the corresponding estimates.

3.25. Events occurred after the balance sheet date

Events after the balance sheet date that provide additional information about conditions existing at the balance sheet date are reflected in the financial statements. Events after the balance sheet date that provide information about conditions that occur after the balance sheet date are not reflected in the financial statements, but are disclosed in the notes to the financial statements, if material.

4. Cash flows

For the purposes of the cash flow statement, the caption “Cash and cash equivalents” includes cash, bank deposits immediately available and other short-term investments with high liquidity and with initial maturities up to three months, net of bank overdrafts.

The Company is exposed to a liquidity risk if its sources of funding, including cash balance, operating cash inflows, divestments and cash flows obtained from financing operations, do not match with our financing needs, such as operating and financing outflows, investments, shareholder remuneration and debt repayments. Based on the cash flows generated by its operations, on the available cash and in the possibility to obtain financing from Portugal Telecom under the centralized cash management system implemented in the Group, the Company believes that it is able to meet its obligations.

PT Comunicações
Notes to Financial Statements (Continued)
As at 31 December 2012
(Amounts in Euro)

4. Cash flows (Continued)

The cash flow statement was prepared in accordance with “NCRF 2 Statement of Cash Flows”, which includes the following:

(a) Cash receipts of income taxes

The Company is part of the special taxation regime for Groups of companies adopted by Portugal Telecom, and as such income taxes and withholding taxes by third parties are recorded on the balance sheet as payables and receivables from Portugal Telecom (Note 12). In this context, the Company received in 2012 an amount of Euro 35,940,339 and paid in 2011 an amount of Euro 52,218,724.

The payments made in 2011 reflect primarily the payments made by PT Prime on behalf of PT Comunicações, amounting to Euro 57,295,923, which relate mainly to payments on account related to the 2011 income tax payable in 2012 and the settlement of the fourth and last instalment due on the 2010 income tax. As a result of the merger of this affiliated company undertaken at the end of 2011, effective as from 1 January, and because PT Comunicações presented a tax loss in 2011, the Company recovered in 2012 the payments on account made in 2011, amounting to Euro 38,662,510.

(b) Cash receipts resulting from loans granted

In 2011, this caption relates to a partial reimbursement, amounting to Euro 160,000,000 (Note 12.1), regarding loans granted to TMN.

(c) Dividends received

In 2012 and 2011, PT Comunicações received dividends from the following companies:

	2012	2011
	Euro	
TMN (Nota 10)	235,479,275	—
CTM—Companhia de Telecomunicações, S.A.R.L. (“CTM”) ⁽ⁱ⁾	2,625,352	2,134,792
Multicert—Serviços de Certificação Electrónica, S.A. (Nota 10)	117,198	—
Infonet Portugal—Serviços de Valor Acrescentado, Lda. (Nota 10)	51,328	255,241
	238,273,153	2,390,033

(i) The amounts received from this affiliated company differed from the attributable amounts of Euro 2,700,796 and Euro 2,280,036 (Note 10), respectively, as a result of exchange rate differences between the attribution and payment dates.

(d) Payments resulting from financial investments

In 2012 and 2011, this caption is composed as follows:

	2012	2011
	Euro	
Advances for the aquisition of RETI (Note 10)	1,094,382	2,271,730
Acquisition of Fibroglobal—Comunicações Electrónicas, S. A. (“Fibroglobal”) (Note 10) ⁽ⁱ⁾	1,000,000	—
Acquisition of PT Blueclip—Serviços de Gestão, S. A. (“PT Blue Clip”) (Note 10)	50,000	—
Other	15,990	4,252
	2,160,372	2,275,982

(i) During the year 2012, PT Comunicações subscribed a share capital increase of this company for a total amount of Euro 1,000,000, a result of which obtained a 5% interest in Fibroglobal, which was recorded under the caption “Financial investments—other methods”.

PT Comunicações
Notes to Financial Statements (Continued)
As at 31 December 2012
(Amounts in Euro)

4. Cash flows (Continued)

(e) Cash receipts (payments) related to loans obtained

In 2012 and 2011, cash receipts from loans obtained, net of cash payments from loans obtained, has the following composition:

	2012	2011
	Euro	
Receipts (payments) obtained under commercial paper programmes	1,092,000,000	(227,000,000)
Loans granted by PT Portugal (Note 22.1)	—	727,000,000
Leases and other loans obtained	(21,390,512)	(12,914,385)
Payments to the “Caixa Geral de Aposentações” (Note 22.4) ⁽ⁱ⁾	(454,316,000)	(467,360,397)
Intercompany loans within centralized cash management	(472,161,084)	4,761,996
	144,132,404	24,487,214

(i) As at 31 December 2010 and following the transfer of unfunded regulatory pension obligations, the Company had recognized an account payable to the Portuguese State for the amount of Euro 921.7 million. Of this outstanding amount, the Company repaid Euro 17.4 million and Euro 450.0 million in January and December 2011 (Note 22.4), respectively, and the remaining amount due of Euro 454.3 million (Note 22.4) was repaid in December 2012.

(f) Interest and related expenses

The increase in payments of interest and related expenses, from Euro 155,756,690 in 2011 to Euro 426,211,970 in 2012, reflects primarily lower accrued expenses, which amounted to Euro 163,750,159 and Euro 67,038,381 as at 31 December 2011 and 2012 (Note 24), respectively, corresponding to interest and similar expenses incurred in 2011 and 2012, respectively, but which payment occurred only in the following year.

(g) Cash and cash equivalents

In 2012 and 2011, this caption is composed as follows:

	2012	2011
	Euro	
Cash	14,669,035	35,473,531
Bank deposits immediately available	6,496,946	19,717,856
Cash and bank deposits	21,165,981	55,191,387

5. Changes in accounting policies and estimates and errors

In the year ended 31 December 2012, the Company did not adopt any new or revised standard or interpretation and did not voluntarily change any other accounting policy. In 2012, PT Comunicações reviewed the useful life of certain tangible assets, including mainly transmission equipments, which resulted in lower depreciation and amortization costs by approximately Euro 19 million.

In 2012, no other regulations or new or revised interpretations were issued that are not already in force.

In 2012, no restatements of any material errors or significant changes in accounting estimates were made with respect to previous years.

PT Comunicações
Notes to Financial Statements (Continued)
As at 31 December 2012
(Amounts in Euro)

6. Tangible fixed assets

6.1. Movements in tangible fixed assets

During the years ended 31 December 2012 and 2011, movements occurred in tangible fixed assets were as follows:

	2012								Total
	Land and natural resources	Buildings and other constructions	Basic equipment	Transportation equipment	Administrative equipment	Other tangible fixed assets	Tangible fixed assets in progress	Advances to suppliers of assets	
	Euro								
Gross value									
Opening balance	176,915,964	843,331,948	8,811,120,172	43,405,353	788,963,712	56,033,699	114,855,017	5 11,125	10,835,136,990
Fusão RETI	—	604,699	2,997,334	71,479	—	214,812	—	—	3,888,324
Acquisitions	—	2,680,951	305,153,091	8,977,802	19,113,595	699,219	49,391,694	—	386,016,352
Disposals	(8,831)	—	(3,838,998)	(2,135,330)	(366,729)	(528)	—	—	(6,350,416)
Transfers and write-offs	565,378	4,670,105	(128,587,187)	(2,316,139)	26,282,112	(19,223)	(70,975,542)	51,536	(170,328,960)
Closing balance	177,472,511	851,287,703	8,986,844,412	48,003,165	833,992,690	56,927,979	93,271,169	562,661	11,048,362,290
Accumulated depreciation and impairment losses									
Opening balance	9,819,238	434,943,739	6,703,947,454	31,395,467	693,824,624	54,256,141	—	—	7,928,186,663
Fusão RETI	—	503,007	1,140,012	71,479	—	208,553	—	—	1,923,051
Depreciation of the period (Note 33)	—	35,801,344	362,087,366	5,376,746	62,910,358	665,788	—	—	466,841,602
Disposals	(1,406)	—	(2,570,127)	(1,829,584)	(294,195)	(528)	—	—	(4,695,840)
Transfers and write-offs	(85,163)	(3,943,095)	(150,683,312)	(1,531,744)	(1,304,209)	(46,849)	—	—	(157,594,372)
Closing balance	9,732,669	467,304,995	6,913,921,393	33,482,364	755,136,578	55,083,105	—	—	8,234,661,104
Net value	167,739,842	383,982,708	2,072,923,019	14,520,801	78,856,112	1,844,874	93,271,169	562,661	2,813,701,186
	2011								
	Land and natural resources	Buildings and other constructions	Basic equipment	Transportation equipment	Administrative equipment	Other tangible fixed assets	Tangible fixed assets in progress	Advances to suppliers of assets	Total
	Euro								
Gross value									
Opening balance	159,968,422	771,433,487	8,305,858,930	47,436,103	674,821,976	53,361,133	130,976,667	511,125	10,144,367,843
Fusão PT Prime	—	431,267	380,659,823	883,081	39,344,881	2,525,898	14,548,253	—	438,393,203
Acquisitions	793,000	7,776,249	358,711,426	2,556,179	38,416,684	2 11,937	77,644,085	—	486,109,560
Revalorizações	15,801,251	47,403,756	(189,372,570)	—	—	—	—	—	(126,167,563)
Disposals	(2,132)	(338,002)	(50,797,055)	(2,423,462)	(181,517)	(7,098)	—	—	(53,749,266)
Transfers and write-offs	355,423	16,625,191	6,059,618	(5,046,548)	36,561,688	(58,171)	(108,313,988)	—	(53,816,787)
Closing balance	176,915,964	843,331,948	8,811,120,172	43,405,353	788,963,712	56,033,699	114,855,017	511,125	10,835,136,990
Accumulated depreciation and impairment losses									
Opening balance	9,493,330	386,219,754	6,119,690,764	30,609,724	606,000,461	51,123,640	—	—	7,203,137,673
Fusão PT Prime	—	132,773	296,197,979	527,434	34,704,428	2,458,051	—	—	334,020,665
Depreciation of the period (Note 33)	—	43,027,379	382,078,021	4,822,869	56,752,968	683,643	—	—	487,364,880
Disposals	(441)	(202,275)	(47,457,616)	(1,547,775)	(131,511)	(1,341)	—	—	(49,340,959)
Transfers and write-offs	326,349	5,766,108	(46,561,694)	(3,016,785)	(3,501,722)	(7,852)	—	—	(46,995,596)
Closing balance	9,819,238	434,943,739	6,703,947,454	31,395,467	693,824,624	54,256,141	—	—	7,928,186,663
Net value	167,096,726	408,388,209	2,107,172,718	12,009,886	95,139,088	1,777,558	114,855,017	5 11,125	2,906,950,327

The additions occurred in 2012 and 2011 under the captions “Basic equipment”, “Administrative equipment” and “Tangible fixed assets in progress” relate primarily to the acquisition of software, network infrastructure and terminal equipment focused mainly on the Pay-TV business.

6.2. Revaluations

In 2008, PT Comunicações has changed the accounting policy on the valuation of real estate assets and ducts infra-structure, from the cost model to the revaluation model. The revaluations of real estate assets and ducts infra-structure were recorded as at 30 June and 30 September 2008 and resulted in the revaluation of those assets by Euro 208,268,320 and Euro 866,764,702, respectively. PT Comunicações, following the adoption of the SNC, maintained the accounting policy to use the revaluation model for these classes of assets, under which shall compute revaluation amounts, at maximum, every three years, and evaluates between those 3 year periods the possible existence of evidence that might result in a significant change in the revalued amount of those assets.

PT Comunicações
Notes to Financial Statements (Continued)
As at 31 December 2012
(Amounts in Euro)

6. Tangible fixed assets (Continued)

The determination of the fair value of real estate properties was made by an independent appraiser based primarily on: (i) observable prices of recent market transactions in an active market; (ii) profitability method for commercial and administrative real estate; and (iii) the cost of acquiring or producing similar real estate with the same purpose for technical buildings. Under the first methodology, the main assumptions used in 2008 were the discount rate (average of 8%) and the monthly rent per square meter (average of Euro 6).

The determination of the fair value of the ducts infra-structure was made internally based on the replacement cost approach. This valuation process was based primarily on: (i) current and observable prices of materials and construction work related to the installation of the ducts underground; (ii) the nature of the soil and road surface where ducts are installed, which has an impact on the construction cost; (iii) internal costs directly attributable to the construction of the ducts infra-structure network; (iv) a depreciation factor, in order to ensure that the replacement cost is consistent with the remaining useful life of the assets revalued; and (v) a technological factor, which reflects the technological changes occurred, namely related to the kinds of ducts which no longer exist and were replaced by other ones. Generally, the prices of materials and construction work together with other qualitative assumptions referred to above resulted in a valuation of the ducts infra-structure in 2008 which reflects an average cost per meter of duct between Euro 58 and Euro 119, depending on the area where the infra-structure is located.

In accordance with the Company's accounting policy to revalue these assets every three years, PT Comunicações performed another revaluation of the real estate assets and transmission infrastructure in 2011, through the same methodology described above. These revaluations were effective as at 31 December 2011 and resulted in a net reduction of tangible assets amounting to Euro 131,418,996, of which Euro 126,167,563 was recognized directly in shareholders' equity, under the caption "Revaluation surplus" (Note 20.6), and an impairment loss of Euro 5,251,433 was recognized in earnings under the caption "Depreciation and amortization ((losses)/reversals)".

The split of these impacts between real estate and telecommunication ducts infrastructure is as follows:

- A reduction in the carrying value of the telecommunication infrastructure amounting to Euro 189,372,570, recognized directly in shareholders' equity in order to reduce the existing revaluation reserves regarding these assets, which is primarily explained by a decrease in the construction cost and also technological improvements, leading to a reduction in the average cost per meter of duct to between Euro 42 and Euro 70, depending on the area where the infra-structure is located; and
- A net increase in the carrying value of real estate assets amounting to Euro 57,953,574, including a gain of Euro 63,205,007 recorded directly in shareholders' equity and a loss of Euro 5,251,433 recognized in the Income Statement. The increase in the carrying value of real estate assets recognized as a result of this revaluation reflects mainly the depreciation expenses recorded over the last three years, which more than offset the reduction in the fair value of these assets. Regarding the main assumption related to this revaluation, the average monthly rent per square meter for the real estate assets that were revalued in both 2008 and 2011 remained broadly stable at Euro 6, although the overall average monthly rent per square meter increased to Euro 7, as a result of real estate assets acquired in 2009 and 2010.

The amortization of the surplus resulting from the revaluation of real estate properties and ducts infra-structure amounted to approximately Euro 10 million and Euro 32 million in 2012, respectively, and to Euro 11 million and Euro 45 million in 2011, respectively. Consequently, if these assets had been carried under the cost model, the carrying amounts of the real estate properties and the ducts infra-structure as of 31 December 2012 would have been reduced by approximately Euro 179 million and Euro 498 million, respectively.

PT Comunicações
Notes to Financial Statements (Continued)
As at 31 December 2012
(Amounts in Euro)

6. Tangible fixed assets (Continued)

For other classes of assets that were previously revalued to the date of transition to NCRF, the Company opted, under the adoption of new accounting standards, to consider the book value at the date of transition as deemed cost, as permitted by the exception foreseen in paragraph 10 of NCRF 3, so that these assets are measured according to the cost model.

In accordance with the applicable legislation, a portion (40%) of the increase in depreciation resulting from legal revaluations made in previous years, and the entire increase in depreciation resulting from revaluations recognized in 2008 do not constitute a cost for the purpose of determining corporate income tax payable (except the revaluations resulting from Decree-Law no. 126/77 of April 2, which are included in their entirety). Consequently, a deferred tax liability was recorded corresponding to the revaluation surplus to be realized (Note 15).

6.3. Other situations related to tangible fixed assets

During the years ended 31 December 2012 and 2011, the following expenses were included in the carrying value of tangible assets and intangible assets in progress:

	2012	2011
	Euro	
Materials consumed	3,094,392	4,020,725
Wages and salaries	33,646,133	31,817,292
Other expenses and losses	5,323,514	4,681,663
	42,064,039	40,519,680

The nature of the main projects that include own work capitalized relates to the planning, supervision and monitoring of installation of terminal equipment, namely IPTV equipment and Fiber-to-the-Home ("FTTH").

For the net carrying value of tangible fixed assets as at 31 December 2012, we note the following:

- There are buildings installed in properties of third parties in the total amount of Euro 8,415,303;
- There are assets of PT Comunicações composed mainly of real estate, that were not registered under the Company's name amounting to Euro 9,240,550, of which Euro 1,570,804 are registered under the name of PT SGPS;
- The Company has tangible fixed assets located overseas with a net book value of Euro 15,448,762, including primarily participation in submarine cable consortiums;
- The tangible fixed assets which, under the terms of article 5 of the Annex to Decree-Law no. 31/2003 of February 17 which constituted the Bases for the Concession of Public Telecommunications Service (Note 1), are subject to the Concession, had a carrying value of Euro 1,765,103,812.

PT Comunicações
Notes to Financial Statements (Continued)
As at 31 December 2012
(Amounts in Euro)

7. Investment properties

During the years ended 31 December 2012 and 2011, movements occurred in this caption were as follows:

	2012	2011
	Euro	
Gross value		
Opening balance	17,791,958	25,818,088
Transfers, adjustments and other	(999,538)	(8,026,130)
Closing balance	16,792,420	17,791,958
Accumulated amortisation and impairment losses		
Opening balance	5,399,654	11,064,079
Amortisation (Nota 33)	482,639	450,348
Transfers, adjustments and other	2,046,290	(6,114,773)
Closing balance	7,928,583	5,399,654
Net value	8,863,837	12,392,304

Land and buildings that were not used in operating activities as at 31 December 2012 and 2011 were classified under this caption, according to the accounting policy adopted by the Company.

These assets are stated at acquisition cost less accumulated depreciation and impairment losses, if any. PT Comunicações makes periodic valuations of these assets. As at 31 December 2012, the real estate book value with acquisition cost exceeding Euro 50,000 amounted to approximately Euro 8.9 million, whereas the corresponding market value amounted to Euro 9.1 million.

During the years ended 31 December 2012 and 2011, PT Comunicações has obtained rental income from this real estate amounting to Euro 638,953 and Euro 640,122, respectively, which were classified under the caption "Other income and gains" (Note 31).

8. Goodwill

The composition of goodwill as at 31 December 2012 and 2011, computed following the acquisition of subsidiaries, some of which were subsequently merged into the Company, is as follows:

<u>Entity</u>	<u>Year of acquisition</u>	<u>Carrying value</u>
		Euro
Mobile Business (TMN)	2010	2,145,416,586
Wireline Business		
Internet Business / portal (ex-PT.Com)	2007	560,447,103
Corporate Business (ex-PT Prime)	2007	235,323,593
International Business (ex-Marconi)	2000	41,255,121
		2,982,442,403

For the purposes of impairment tests, goodwill was allocated to cash generating units. The recoverable amount was determined from the respective value in use through the discounted cash flows methodology, using a cash flow forecast of a four year period, which was prepared internally. The discount rate applied to projected cash flows, which was determined taking into account the risk

PT Comunicações
Notes to Financial Statements (Continued)
As at 31 December 2012
(Amounts in Euro)

8. Goodwill (Continued)

associated with each business, and the growth rates used to extrapolate cash flow projections beyond the period covered by the forecasts prepared internally were as follows:

<u>Assumptions</u>	<u>Internet Business</u>	<u>Corporate Business</u>
Growth rate	1.0% - 1.5%	1.0% - 1.5%
Discount rate	8.9% - 9.9%	8.9% - 9.9%

The recoverable amount of each cash generating unit was determined for the minimum and maximum values listed in the table above and the Company's management concluded that, as at 31 December 2012, the book value of the cash generating unit, including goodwill, did not exceed its recoverable amount.

9. Intangible assets

During the years ended 31 December 2012 and 2011, movements occurred in intangible assets were as follows:

	<u>2012</u>			<u>Total</u>
	<u>Industrial property and other rights</u>	<u>Other intangible assets</u>	<u>Intangible assets in progress</u>	
	Euro			
Gross value				
Opening balance	497,805,369	487,590	1,694,348	499,987,307
Acquisitions	5,553,990	220,502	1,049,571	6,824,063
Transfers and write-offs	11,488	—	(1,694,348)	(1,682,860)
Closing balance	<u>503,370,847</u>	<u>708,092</u>	<u>1,049,571</u>	<u>505,128,510</u>
Accumulated amortisation and impairment losses				
Opening balance	240,002,357	168,352	—	240,170,709
Amortisation (Nota 33)	30,161,753	168,655	—	30,330,408
Transfers and write-offs	(645,285)	—	—	(645,285)
Closing balance	<u>269,518,825</u>	<u>337,007</u>	<u>—</u>	<u>269,855,832</u>
Intangible assets, net	<u>233,852,022</u>	<u>371,085</u>	<u>1,049,571</u>	<u>235,272,678</u>

PT Comunicações
Notes to Financial Statements (Continued)
As at 31 December 2012
(Amounts in Euro)

9. Intangible assets (Continued)

	2011			Total
	Industrial property and other rights	Other intangible assets	Intangible assets in progress	
	Euro			
Gross value				
Opening balance	463,778,961	239,570	4,052,004	468,070,535
PT Prime merger	777,275	—	—	777,275
Acquisitions	28,113,187	57,020	1,016,395	29,186,602
Transfers and write-offs	5,135,946	191,000	(3,374,051)	1,952,895
Closing balance	497,805,369	487,590	1,694,348	499,987,307
Accumulated amortisation and impairment losses				
Opening balance	209,058,661	66,547	—	209,125,208
PT Prime merger	730,716	—	—	730,716
Amortisation (Nota 33)	30,063,420	101,805	—	30,165,225
Transfers and write-offs	149,560	—	—	149,560
Closing balance	240,002,357	168,352	—	240,170,709
Intangible assets, net	257,803,012	319,238	1,694,348	259,816,598

In 2012, additions under the caption “Industrial property and other rights” relate primarily to (1) the acquisition of software licenses regarding projects to develop new applications and features in the commercial, financials and logistic areas. In 2011, additions include primarily (1) the commitments assumed under the DTT license (Note 1), amounting to Euro 23,595,180, and (2) the acquisition of software licenses with same nature of those mentioned above.

As at 31 December 2012, the net book value of the caption “Industrial property and other rights” includes mainly:

- An amount of Euro 185 million related to the acquisition of full ownership of the Basic Network by PT Comunicações to the Portuguese State, concluded in December 2002, which corresponds to the gross value capitalized in 2002 amounting Euro 339 million net of accumulated depreciation;
- An amount of Euro 16 million related to a contract entered into by PT Comunicações in 2007 and 2009 for the acquisition of satellite capacity rights until 2015, which was recorded as a financial lease; and
- An amount of Euro 23 million, corresponding to the TDT licenses recorded in 2011.

In 2012 and 2011, the Company performed innovation, research and development activities under which the following expenses and fixed assets were recorded:

	2012	2011
	Euro	
Tangible fixed assets	72,940,479	134,591,146
Intangible assets	1,424,785	2,021,607
Other operation expenses	10,796,763	11,611,026
Total	85,162,027	148,223,779

PT Comunicações
Notes to Financial Statements (Continued)
As at 31 December 2012
(Amounts in Euro)

10. Financial investments—equity method of accounting

During the years ended 31 December 2012 and 2011, the movements occurred under this caption were as follows (Note 12):

	2012			Total
	Investments in subsidiary companies	Investments in associated companies	Advances for financial investments ^(a)	
	Euro			
Gross value				
Opening balance	7,675,544,256	5,794,961	6,771,730	7,688,110,947
Reti merger ^(a)	(71,699)	—	—	(71,699)
Increases	50,000	—	1,094,382	1,144,382
Equity method	(183,670,364)	2,867,410	—	(180,802,954)
Dividends	(235,530,603)	(2,817,994)	—	(238,348,597)
Non current assets held for sale ^(b) . .	—	(5,069,882)	—	(5,069,882)
Other ^(a)	71,699	—	(7,866,112)	(7,794,413)
Closing balance	7,256,393,289	774,495	—	7,257,167,784
Impairment losses				
Opening balance	—	—	6,771,730	6,771,730
Increases	—	—	1,094,382	1,094,382
Other	—	—	(7,866,112)	(7,866,112)
Closing balance	—	—	—	—
Financial investments, net	7,256,393,289	774,495	—	7,257,167,784

(a) On 3 May 2012, PT Comunicações concluded the acquisition of an investment in RETI that was previously held by TVI, through the payment of the fifth and last installment, amounting to Euro 1,094,382, that was considered in an agreement entered in December 2009, and following the amounts already paid in previous years as advances for financial investments, for the total amount of Euro 6,771,730. These amounts were fully adjusted based on the Company's expectation that RETI's analogical network was redundant considering the network of PT Comunicações. As a result of the acquisition of this investment, the Company recorded an investment of Euro 71,699, corresponding to the shareholders' equity of the acquired company, and recorded a goodwill of Euro 7,794,413, corresponding to the difference between the acquisition price of Euro 7,866,112 and the financial investment. Both the goodwill and the impairment losses recognized in previous years over payments made or to be made under the agreement entered into in December 2009, amounting to Euro 7,866,112, were transferred to net income. In December 2012, the Board of Directors of both companies approved the merger of RETI into PT Comunicações as from 3 May 2012 and, as such, the Company eliminated the financial investment in RETI, amounting to Euro 71,699, and recorded in its balance sheet the assets and liabilities of RETI as of that date that were transferred to PT Comunicações.

(b) On 13 January 2013, as mentioned in Note 37, Portugal Telecom entered into a definitive agreement for the sale of the 28% stake held by the Group in the share capital of CTM, including the 25% and 3% interests held by PT Participações and PT Comunicações, respectively. Consequently, the Company's investment in CTM was classified as a non-current asset held for sale as at 31 December 2012. This transaction, which is still pending the satisfaction of a set of precedent conditions will allow the Group to receive a total amount of 411.6 million US dollars, subject to certain cash flow adjustments, amount that should be splitted proportionally between the companies that hold this investment.

PT Comunicações
Notes to Financial Statements (Continued)
As at 31 December 2012
(Amounts in Euro)

10. Financial investments—equity method of accounting (Continued)

	2011			Total
	Investments in subsidiary companies	Investments in associated companies	Advances for financial investments ^(a)	
	Euro			
Gross value				
Opening balance	7,920,681,613	4,802,228	4,500,000	7,929,983,841
PT Prime merger ^(a)	(155,822,823)	1,002,908	—	(154,819,915)
Increases	—	—	2,271,730	2,271,730
Reductions	—	(169,172)	—	(169,172)
Equity method	(79,035,450)	2,439,033	—	(76,596,417)
Dividends	(255,241)	(2,280,036)	—	(2,535,277)
Other movements ^(b)	(10,023,843)	—	—	(10,023,843)
Closing balance	<u>7,675,544,256</u>	<u>5,794,961</u>	<u>6,771,730</u>	<u>7,688,110,947</u>
Impairment losses				
Opening balance	—	—	4,500,000	4,500,000
Increases	—	—	2,271,730	2,271,730
Closing balance	<u>—</u>	<u>—</u>	<u>6,771,730</u>	<u>6,771,730</u>
Financial investments, net	<u>7,675,544,256</u>	<u>5,794,961</u>	<u>—</u>	<u>7,681,339,217</u>

(a) This caption includes: (i) the elimination of the Company's financial investment recorded as at 31 December 2010 in relation to its former affiliated company PT Prime, corresponding to the shareholders' equity of such company on that date, amounting to Euro 157,378,990, and (ii) the financial investments of PT Prime in its affiliated companies, which were transferred to the Company as a result of this merger, amounting to Euro 2,559,075.

(b) This caption relates to the disposal of certain network assets to TMN and corresponds to the difference between the disposal price (fair value) and the respective carrying value, since as this was a transaction with an affiliated company, the related capital gain was eliminated and recorded as a reduction to the financial investment in TMN, in order to offset the excess depreciation that TMN will recognize regarding these assets in relation to the depreciation that would have been recognized if these assets had not been disposed of.

In 2012 and 2011, increases the gross value of financial investments accounted for by the equity method gross were as follows:

	2012	2011
	Euro	
Acquisition of PT Blueclip (Note 4)	50,000	—
Advances for the acquisition of financial investments (Note 4)	1,094,382	2,271,730
	<u>1,144,382</u>	<u>2,271,730</u>

During the year ended 31 December 2011, the reduction in gross value of investments recorded under the equity method of accounting, amounting to Euro 169,172, relates to the liquidation of Tele Larm, in which the Company held a 50% interest.

PT Comunicações
Notes to Financial Statements (Continued)
As at 31 December 2012
(Amounts in Euro)

10. Financial investments—equity method of accounting (Continued)

In 2012 and 2011, the movements occurred in investments in subsidiaries and associated companies resulting from the application of the equity method of accounting were recorded as follows:

	2012	2011
	Euro	
Gains in affiliated companies net (Note 26)	120,535,593	153,286,767
Adjustments to financial assets (Note 20.5)	(301,338,547)	(229,883,184)
	(180,802,954)	(76,596,417)

The detail of dividends attributed by subsidiaries and associated companies in 2012 and 2011 is as follows (Note 4):

	2012	2011
	Euro	
TMN	235,479,275	—
CTM	2,700,796	2,280,036
Multicert	117,198	—
Infonet	51,328	255,241
	238,348,597	2,535,277

11. Post-retirement benefits

As referred to in Note 3, PT Comunicações is responsible for the payment of post-retirement benefits under defined benefit plans, which include pensions and pension supplements to retired and active employees, healthcare services after retirement age and salaries to suspended and pre-retired employees.

The actuarial valuations of Portugal Telecom's defined benefit plans as at 31 December 2012, 2011 and 2010 were computed based on the projected unit credit method and considered the following main financial and demographic actuarial assumptions:

	2012	2011	2010
	Euro		
Financial assumptions			
Discount rate for obligations related to:			
Pension supplements	3.00%	4.75%	4.75%
Salaries to suspended and pre-retired employees			
Healthcare	2.00%	3.75%	3.75%
Salary growth rate for obligations related to:			
Pension supplements and healthcare	4.00%	4.75%	4.75%
Salaries to suspended and pre-retired employees	1.75%	1.75%	1.75%
Pension growth rate	0,00%—1,75% ⁽ⁱ⁾	0,00%—1,75% ⁽ⁱ⁾	1.75%
Social Security sustainability factor	GDP linked	GDP linked	GDP linked
Inflation rate	Applicable	Applicable	Not applicable
Healthcare cost trend growth rate	2.00%	2.00%	2.00%
Expected return on assets	3.00%	3.00%	3.00%
	6.00%	6.00%	6.00%

(i) For salaries payable between 2013 and 2017, the salary growth rate ranges from 0% to 1% depending on the amount of the salary. As from 2018, the salary growth rate is 1.75% for all situations.

PT Comunicações
Notes to Financial Statements (Continued)
As at 31 December 2012
(Amounts in Euro)

11. Post-retirement benefits (Continued)

	2012	2011	2010
		Euro	
Demographic assumptions			
Mortality tables for active beneficiaries:			
Males	PA (90)m adjusted	AM (92)	AM (92)
Females	PA (90)m adjusted	AF (92)	AF (92)
Mortality tables for non-active beneficiaries:			
Males	PA (90)m adjusted	PA (90)m adjusted	PA (90)m adjusted
Females	PA (90)f adjusted	PA (90)f adjusted	PA (90)f adjusted
Disability table (Swiss Reinsurance Company)	25%	25%	25%
Active employees with spouses under the plan	35%	35%	35%
Turnover of employees	Nil	Nil	Nil

The changes in actuarial assumptions were primarily due to changes occurred in market conditions.

The discount rate was computed based on long-term yield rates of high-rating bonds as of the date of the Balance sheet for durations comparable to the liabilities for pensions and pension supplements, salaries and health care benefits (between 4 and 15 years).

The rate of return on long-term fund assets was estimated based on historical information on the return of portfolio assets, the expected portfolio in future years and certain financial market performance indicators usually considered in market analysis.

Salary growth rate was established in accordance with Group policy for wages and salaries and pension growth rates and the sustainability factor was established in line with Portuguese Government information.

Demographic assumptions considered by Portugal Telecom are based on mortality tables generally accepted for actuarial valuation purposes, with these tables being periodically adjusted to reflect the actual mortality rates observed among the plan participants.

In 2012 and 2011, the total impact of changes in actuarial assumptions a net loss of Euro 136,212,106, and a net gain of Euro 19,337,022 (Notes 11.7), respectively, and was recognized directly in shareholders' equity.

The impact of an increase by 25 basis points on the average discount rate actuarial assumption would be a decrease of the responsibilities for post-retirement benefits by approximately Euro 21 million as at 31 December 2012, while the impact of an increase (decrease) in the health care cost trend rate by 1% would be an increase (decrease) of the responsibilities for post-retirement benefits by approximately Euro 71 million (Euro 58 million) as at 31 December 2012.

The impact of an increase (decrease) by 1% in the rate of return on long-term fund assets would be a decrease (increase) of post-retirement benefit costs in the year 2012 by approximately Euro 3 million, corresponding to the increase (decrease) in expected return on assets, and the impact of an increase (decrease) by 1% in the health care cost trend rate would be an increase (decrease) of post-retirement benefit costs in the year 2012 by approximately Euro 4 million (Euro 3 million).

11.1. Supplement benefits

As referred to in Note 3, prior to the transfer of pension obligations to the Portuguese State, PT Comunicações was responsible for the payment of regulatory pensions and pension supplements to

PT Comunicações
Notes to Financial Statements (Continued)
As at 31 December 2012
(Amounts in Euro)

11. Post-retirement benefits (Continued)

retired and active employees, and is no longer responsible for the payment of regulatory pensions following that transfer. These liabilities, which were estimated based on actuarial valuations, are as follows:

- a) Retirees and employees of TLP and TDP hired prior to 23 June 1994 are entitled to receive a pension supplement from PT Comunicações, which complements the pension paid by the Portuguese social security system.
- b) Retirees and employees of Companhia Portuguesa Rádio Marconi, SA (“Marconi”, a company merged into PT Comunicações in 2002) hired prior to 1 February 1998 are entitled to a supplemental pension benefit (“Marconi Complementary Fund”). In addition, PT Comunicações contributes to the fund “Fundo de Melhoria Marconi” with 1.55% of the salaries paid to these employees, which is responsible to pay the additional pension supplement.
- c) On retirement, PT Comunicações pays a lump sum gratuity of a fixed amount which depends on the length of service completed by the employee.

Employees hired by PT Comunicações or any of its predecessor companies after the dates indicated above are not entitled to these benefits, as they are covered by the general Portuguese Government social security system.

As at 31 December 2012, pension supplement plans from PT Comunicações covered 19,814 beneficiaries, of which approximately 63% are non active.

Based on the actuarial reports, the pension benefit obligation and the fair value of the pension funds as at 31 December 2012 and 2011 were as follows:

	2012	2011
	Euro	
Projected benefit obligations related to pension, pension supplements and gratuities	126,751,790	121,168,176
Pension funds assets at fair value	(99,529,441)	(98,480,548)
Unfunded pension obligations	27,222,349	22,687,628
Prior years’ service gains ^(a)	3,079,179	3,998,608
Present value of unfunded pension obligations (Note 11.4)	30,301,528	26,686,236

(a) This caption refers to the component of the prior years’ service gains resulting from the changes in the benefits granted under pension supplement plans related to unvested rights. This amount will be recognized in earnings during the estimated period in which those benefits will be used by employees (9 years).

PT Comunicações
Notes to Financial Statements (Continued)
As at 31 December 2012
(Amounts in Euro)

11. Post-retirement benefits (Continued)

During the years ended 31 December 2012 and 2011, the movement in the projected benefit obligations was as follows:

	2012	2011
	Euro	
Opening balance of the projected benefit obligation	121,168,176	129,290,651
Payments of benefits and contributions		
Benefits paid by the Company (Note 11.5)	(983,643)	(1,109,982)
Benefits paid by the funds	(9,392,359)	(9,692,964)
Pension costs		
Service cost	442,893	460,701
Interest cost	5,345,763	5,712,999
Work force reduction programme costs	87,682	10,245
Net actuarial losses	9,878,905	(3,503,474)
Transfers between plans (Note 11.3)	204,373	—
Closing balance of the projected benefit obligation	126,751,790	121,168,176

During the years ended 31 December 2012 and 2011, the movement in the projected benefit obligations was as follows:

	2012		2011	
	Amount	%	Amount	%
	Euro			
Equities	19,922,371	20.0%	19,994,550	20.3%
Bonds	60,201,161	60.5%	58,907,519	59.8%
Property ^(a)	2,545,908	2.6%	2,713,542	2.8%
Cash, treasury bills, short-term stocks and other assets	16,860,001	16.9%	16,864,937	17.1%
	99,529,441	100.0%	98,480,548	100.0%

(a) During the years ended 31 December 2011, in connection with the transfer of unfunded pension obligations to the Portuguese State, Portugal Telecom acquired from the pension funds all real estate properties that were rented to Group companies and recognized them under the caption "Tangible fixed assets" for an amount of Euro 3 million.

Portugal Telecom is exposed to risks related to the changes in the fair value of the plan assets associated with Portugal Telecom's post-retirement defined pension supplement plans. The main purpose of the established investment policy is capital preservation through five main principles: (1) diversification; (2) stable strategic asset allocation and disciplined rebalancing; (3) lower exposure to currency fluctuations; (4) specialized instruments for each class of assets; and (5) cost control.

During the years ended 31 December 2012 and 2011, the movement in the plan assets was as follows:

	2012	2011
	Euro	
Opening balance of the plan assets	98,480,548	109,335,604
Actual return on assets	9,341,252	(2,812,092)
Payments of benefits	(9,392,359)	(9,692,964)
Contributions made by the Company (Note 11.5)	1,100,000	1,650,000
Closing balance of the plan assets	99,529,441	98,480,548

PT Comunicações
Notes to Financial Statements (Continued)
As at 31 December 2012
(Amounts in Euro)

11. Post-retirement benefits (Continued)

A summary of the components of the pension net cost recorded in the years ended 31 December 2012 and 2011 is presented below:

	2012	2011
	Euro	
Service cost	442,893	460,701
Interest cost	5,345,763	5,712,999
Expected return on plan assets	(5,633,800)	(6,278,854)
Amortization of prior years' service gains ^(a)	(622,156)	(624,094)
Current pension cost (Notes 11. 4 and 11.6)	(467,300)	(729,248)
Work force reduction program	87,682	10,245
Prior years' service gains (extraordinary amortization)	(297,273)	(12,281)
Total cost of redundancy programme (Notes 11. 4 and 11.6)	(209,591)	(2,036)
Total pension cost	(676,891)	(731,284)

(a) In 2012 and 2011, this caption corresponds to the annual amortisation of unrecognized prior year service gains obtained in previous years.

Actuarial gains and losses, which result from changes in actuarial assumptions and from differences between those actuarial assumptions and actual data, are recognized directly in shareholders' equity. During the years ended 31 December 2012 and 2011, the movement in accumulated net actuarial losses was as follows:

	2012	2011
	Euro	
Opening balance	121,803,871	116,216,399
Change in actuarial assumptions (Note 11.7)	17,334,547	(374,801)
Differences between actual data and actuarial assumptions (Note 11.7)		
Pension benefit obligation related ^(a)	(7,455,642)	(3,128,673)
Asset related	(3,707,452)	9,090,946
Closing balance	127,975,324	121,803,871

(a) Differences between actual data and actuarial assumptions related to the PBO, results mainly from updated information regarding beneficiaries.

11.2. Health care benefits

As referred to in Note 3, PT Comunicações is responsible for the payment of post-retirement health care benefits to certain employees, suspended employees, pre-retired employees, retired employees and their eligible relatives. Health care services are rendered by PT-ACS, which was incorporated with the sole purpose of managing the Company's Health Care Plan.

This plan, sponsored by PT Comunicações, includes all employees hired by PT Comunicações until 31 December 2000 and by Marconi until 1 February 1998.

As at 31 December 2012, healthcare plan from PT Comunicações covered 23.894 beneficiaries related to employees and former employees, of which approximately 76% are non-active at both dates. In addition, as at 31 December 2011, these plans also covered 10.850 beneficiaries related to relatives of employees and former employees, respectively.

PT Comunicações
Notes to Financial Statements (Continued)
As at 31 December 2012
(Amounts in Euro)

11. Post-retirement benefits (Continued)

The financing of the Health Care Plan is assured by defined contributions made by participants to PT ACS and the remainder by PT Comunicações, which incorporated a fund in 2004 that is managed independently for this purpose.

Based on the actuarial reports, the benefit obligation and the fair value of health care funds and prior year's service gains not yet recognized as at 31 December 2012 and 2011 are as follows:

	2012	2011
	Euro	
Projected benefit obligations	374,474,961	351,843,072
Plan assets at fair value	(299,865,329)	(246,214,842)
Net unfunded obligations	74,609,632	105,628,230
Prior years' service gains ^(a)	11,119,675	11,955,435
Present value of net unfunded obligations (Note 11.4)	85,729,307	117,583,665

(a) This caption refers to the component of the prior years' service gains resulting from the changes in the health care plan made in previous years related to those benefits that are not yet vested. This amount was deferred and will be recognized in earnings during the estimated period in which those benefits will be earned by employees.

During the years ended 31 December 2012 and 2011, the movement in the projected benefit obligations was as follows:

	2012	2011
	Euro	
Opening balance of the projected benefit obligations	351,843,072	341,823,966
Benefits paid by the Company (Note 11.5)	(18,977,302)	(17,964,841)
Pension costs		
Service cost	2,988,477	2,975,899
Interest cost	16,326,001	15,839,912
Work force reduction costs	(163,036)	186,854
Net actuarial losses	22,457,749	8,981,282
Closing balance of the projected benefit obligations	374,474,961	351,843,072

As at 31 December 2012 and 2011, the portfolio of the Company's autonomous fund to cover post-retirement health care benefit obligations was as follows:

	Amount		Amount	
	2012	%	2011	%
	Euro			
Equities ^(a)	75,277,597	25.1%	41,289,896	16.8%
Bonds ^(b)	88,178,641	29.4%	89,155,632	36.2%
Cash, treasury bills, short-term stocks and other assets ^(c)	136,409,091	45.5%	115,769,314	47.0%
	299,865,329	100.0%	246,214,842	100.0%

(a) As at 31 December 2012 and 2011, this caption corresponds to investments in shares of Banco Espírito Santo, one Portugal Telecom's shareholder.

(b) As at 31 December 2012 and 2011, this caption includes investments in bonds of Portugal Telecom amounting to Euro 66 million and Euro 56 million, respectively

(c) As at 31 December 2012 and 2011, this caption includes investments in the private equity funds "Ongoing International Capital Markets" and "Ongoing International Private Equity" totalling Euro 104 million and Euro 79 million, respectively, which are managed by Global Investment Opportunities SICAV, former Ongoing International, a Portugal Telecom's shareholder.

PT Comunicações
Notes to Financial Statements (Continued)
As at 31 December 2012
(Amounts in Euro)

11. Post-retirement benefits (Continued)

During 2012 and 2011, the movement in the plan assets was as follows:

	2012	2011
	Euro	
Opening balance of the plan assets	246,214,842	338,810,084
Actual return on assets	74,473,916	(69,303,386)
Refunds (Note 11.5) ^(a)	(20,823,429)	(23,291,856)
Closing balance of the plan assets	299,865,329	246,214,842

(a) This caption relates to refunds of expenses paid by PT Comunicações on behalf of PT ACS.

A summary of the components of the net periodic post-retirement health care cost in 2012 and 2011 is presented below:

	2012	2011
	Euro	
Service cost	2,988,477	2,975,899
Interest cost	16,326,001	15,839,912
Expected return on plan assets	(14,284,623)	(19,827,477)
Prior years' service gains	(840,553)	(841,263)
Current cost (Notes 11.4 and 11.6)	4,189,302	(1,852,929)
Work force reduction program costs	(163,036)	186,854
Prior years' service gains (extraordinary amortization)	4,793	(6,302)
Total cost of redundancy programme (Notes 11.4 and 11.6)	(158,243)	180,552
Health care cost	4,031,059	(1,672,377)

Actuarial gains and losses, which result from changes in actuarial assumptions and from differences between those actuarial assumptions and actual data, are recognized directly in shareholder's equity. During the years ended 31 December 2012 and 2011, the movement in accumulated net actuarial losses was as follows:

	2012	2011
	Euro	
Opening balance	317,951,850	219,839,705
Change in actuarial assumptions (Note 11.7)	37,439,494	—
Differences between actual data and actuarial assumptions (Note 11.7):		
Health care benefit obligation related	(14,981,745)	8,981,282
Assets related	(60,189,293)	89,130,863
Closing balance	280,220,306	317,951,850

11.3. Pre-retired and suspended employees

As mentioned in Note 3, PT Comunicações is also responsible for the payment of salaries to suspended and pre-retired employees until they reach the Portuguese social security retirement age. As at 31 December 2012, there were 5,441 suspended and pre-retired employees.

These liabilities are not subject to any legal funding requirement, therefore the monthly payment of salaries is made directly by PT Comunicações.

PT Comunicações
Notes to Financial Statements (Continued)
As at 31 December 2012
(Amounts in Euro)

11. Post-retirement benefits (Continued)

During the years ended 31 December 2012 and 2011, the movement in the projected benefit obligation was as follows:

	2012	2011
	Euro	
Opening balance of the projected benefit obligation	779,921,779	922,663,206
Merger PT Prime (Note 11.4)	—	296,073
Benefits paid by the Company (Notes 11.4 and 11.5)	(159,183,194)	(173,540,423)
Interest cost (Notas 11.4 e 11.6)	25,657,325	31,348,662
Work force reduction costs (Notas 11.4 e 11.6)	(246,969)	31,034,557
Net actuarial losses (Note 11.7)	81,313,511	(31,880,296)
Transfers between plans (Note 11.1)	(204,373)	—
Closing balance of the projected benefit obligation (Note 11.4) .	727,258,079	779,921,779

Actuarial gains and losses, which result from changes in actuarial assumptions and from differences between those actuarial assumptions and actual data, are recognized directly in shareholders' equity. During the years ended 31 December 2012 and 2011, the movement in accumulated net actuarial losses was as follows:

	2012	2011
	Euro	
Opening balance	83,152,610	115,032,906
Change in actuarial assumptions (Note 11.7)	81,438,065	(18,962,221)
Differences between actual data and actuarial assumptions (Note 11.7)	(124,554)	(12,918,075)
Closing balance	164,466,121	83,152,610

PT Comunicações
Notes to Financial Statements (Continued)
As at 31 December 2012
(Amounts in Euro)

11. Post-retirement benefits (Continued)

11.4. Responsibilities for post-retirement benefits

The movements observed in post-retirement benefit obligations, net of the related asset funds, during the years ended 31 December 2012 and 2011 were as follows:

	Pension benefits (Note 11.1)	Health care benefits (Note 11.2)	Salaries to pre-retired and suspended employees	Total
	Euro			
Balance as at 1 January 2011	24,590,030	15,816,882	922,663,206	963,070,118
PT Prime merger (Note 11.3)	—	—	296,073	296,073
Net periodic pension cost/(gain) (Note 11.6)	(729,248)	(1,852,929)	31,348,662	28,766,485
Work force reduction costs (Note 11.6)	(2,036)	180,552	31,034,557	31,213,073
Payments, contributions and refunds (Note 11.5)	(2,759,982)	5,327,015	(173,540,423)	(170,973,390)
Net actuarial losses (gains) (Notes 11.7 and 11.8)	5,587,472	98,112,145	(31,880,296)	71,819,321
Balance as at 31 December 2011 . . .	26,686,236	117,583,665	779,921,779	924,191,680
Transfers between plans	204,373	—	(204,373)	—
Net periodic pension cost/(gain) (Note 11.6)	(467,300)	4,189,302	25,657,325	29,379,327
Work force reduction costs (Note 11.6)	(209,591)	(158,243)	(246,969)	(614,803)
Payments, contributions and refunds (Note 11.5)	(2,083,643)	1,846,127	(159,183,194)	(159,420,710)
Net actuarial losses/(gains) (Notes 11.7 and 11.8)	6,171,453	(37,731,544)	81,313,511	49,753,420
Balance as at 31 December 2012 . . .	30,301,528	85,729,307	727,258,079	843,288,914

Certain post-retirement benefit plans have a surplus position and therefore were presented in the Balance sheet separately from those plans with a deficit position. As at 31 December 2012 and 2011, net post-retirement obligations were recognized in the Balance sheet as follows:

	2012	2011
	Euro	
Plans with a deficit position:		
Pensions	31,934,368	28,374,789
Healthcare (Note 11.2)	85,729,307	117,583,665
Salaries to pre-retired and suspended employees (Note 11.3)	727,258,079	779,921,779
	844,921,754	925,880,233
Plans with a surplus position:		
Pensions	(1,632,840)	(1,688,553)
	(1,632,840)	(1,688,553)
	843,288,914	924,191,680

PT Comunicações
Notes to Financial Statements (Continued)
As at 31 December 2012
(Amounts in Euro)

11. Post-retirement benefits (Continued)

11.5. Cash flows relating to post-retirement benefit plans

During the years ended 31 December 2012 and 2011, the payments and contributions regarding post-retirement benefits were as follows:

	2012	2011
	Euro	
Pensions		
Contributions to the funds (Note 11.1)	1,100,000	1,650,000
Payments of pension supplements (Note 11.1)	983,643	1,109,982
Sub total (Note 11.4)	2,083,643	2,759,982
Health care		
Refunds (Note 11.2)	(20,823,429)	(23,291,856)
Payments of health care expenses (Note 11.2)	18,977,302	17,964,841
Sub total (Note 11.4)	(1,846,127)	(5,327,015)
Other payments		
Payments of salaries to pre-retired and suspended employees (Notes 11.3 and 11.4)	159,183,194	173,540,423
Termination payments (Note 11.6)	1,482,772	1,707,171
Service cost related to liabilities transferred to the Portuguese State ^(a)	25,482,982	21,783,360
Sub total	186,148,948	197,030,954
	186,386,464	194,463,921

(a) This caption corresponds to a fixed contribution paid by PT Comunicações to the Portuguese Social Security System relating to the annual service of active and suspended employees that were entitled to pension benefits under the Company's post-retirement benefit plans that were transferred to the Portuguese State in December 2010.

11.6. Post-retirement benefit costs

In 2012 and 2011, post-retirement benefit costs and curtailment and settlement costs were as follows:

	2012	2011
	Euro	
Post retirement benefits, net		
Pension benefits (Notes 11.1 and 11.4)	(467,300)	(729,248)
Health care benefits (Notes 11.2 and 11.4)	4,189,302	(1,852,929)
Salaries (Notes 11.3 and 11.4)	25,657,325	31,348,662
Service cost related to liabilities transferred to the Portuguese state ^(a)	22,337,313	25,112,665
	51,716,640	53,879,150
Redundancy costs and liquidation		
Pensions (Notes 11.1 and 11.4)	(209,591)	(2,036)
Health care (Notes 11.2 and 11.4)	(158,243)	180,552
Salaries (Notes 11.3 and 11.4)	(246,969)	31,034,557
Termination payments (Note 11.5)	1,482,772	1,707,171
	867,969	32,920,244

(a) This caption corresponds to a fixed contribution paid by PT Comunicações to the Portuguese Social Security System relating to the annual service of active and suspended employees that were entitled to pension benefits under the Company's post-retirement benefit plans that were transferred to the Portuguese State in December 2010.

PT Comunicações
Notes to Financial Statements (Continued)
As at 31 December 2012
(Amounts in Euro)

11. Post-retirement benefits (Continued)

11.7. Net actuarial losses (gains)

In 2012 and 2011, the net actuarial gains and losses recorded in shareholders' equity were as follows:

	2012	2011
	Euro	
Changes in actuarial assumptions		
Pension benefits (Note 11.1)	17,334,547	(374,801)
Health care benefits (Note 11.2)	37,439,494	—
Salaries (Note 11.3)	81,438,065	(18,962,221)
Sub-total (Note 11)	136,212,106	(19,337,022)
Differences between actual data and actuarial assumptions		
Pension benefits (Note 11.1)	(11,163,094)	5,962,273
Health care benefits (Note 11.2)	(75,171,038)	98,112,145
Salaries (Note 11.3)	(124,554)	(12,918,075)
Sub-total	(86,458,686)	91,156,343
Total (Notes 11.4, 11. 8 and 20.4)	49,753,420	71,819,321

Net actuarial losses and gains recorded in 2012 and 2011 related to changes in actuarial assumptions mainly resulting from the changes in the financial and demographic actuarial assumptions detailed above, as follows:

- Net actuarial losses recorded in 2012, amounting to Euro 136 million, include primarily the impacts resulting from (1) the suspension of the early retirement regime (loss of Euro 39 million), either permanently for employees under the CGA regime or during the financial assistance programme to Portugal for the remaining employees, (2) the reduction in the discount rates for responsibilities with pension supplements, health care benefits and salaries payable to suspended and pre-retired employees (loss of Euro 102 million), and (3) the change in the mortality tables for active beneficiaries;
- Actuarial gains recognized in 2011, amounting to Euro 19 million, relate mainly to the reduction in the salary growth rate for obligations in connection with salaries payable to suspended and pre-retired employees.

The detail of net actuarial gains and losses resulting from differences between actual data and actuarial assumptions is as follows:

- Actuarial gains recognized in 2012, amounting to Euro 86 million, include (i) a gain of Euro 64 million related to the difference between actual (+25,2%) and expected (+6.0%) return on fund assets, and (ii) a gain of Euro 23 million corresponding to the difference between actual data and actuarial assumptions regarding projected responsibilities, particular assumptions about growth rates of wages, pensions and health care;
- Actuarial losses recognized in 2011, amounting to Euro 91 million, include (i) a loss of Euro 98 million related to the difference between actual (– 16.6%) and expected (+6.0%) return on fund assets, and (ii) a gain of Euro 7 million corresponding to the difference between actual data and actuarial assumptions regarding projected responsibilities.

11.8. Other disclosures

The table below presents historical data for a five year period about the present value of projected benefit obligations, the fair value of the plan assets, the surplus or deficit in the plans and the net actuarial

PT Comunicações
Notes to Financial Statements (Continued)
As at 31 December 2012
(Amounts in Euro)

11. Post-retirement benefits (Continued)

gains and losses. The detail of this data for all the plans mentioned above as at 31 December 2012, 2011, 2010, 2009 and 2008 and for the years then ended is as follows:

	2012	2011	2010	2009	2008
	Euro				
Projected benefit obligations ^(a)	1,228,484,830	1,252,933,027	1,393,777,823	3,836,029,063	3,940,379,413
Plan assets at fair value ^(a)	(399,394,770)	(344,695,390)	(448,145,688)	(2,369,524,484)	(2,131,646,536)
Net unfunded obligations	829,090,060	908,237,637	945,632,135	1,466,504,579	1,808,732,877
Prior years' service gains	14,198,854	15,954,043	17,437,983	22,438,000	24,449,000
Responsibilities for post retirement benefits, net	843,288,914	924,191,680	963,070,118	1,488,942,579	1,833,181,877
	Euro				
Changes in actuarial assumptions	136,212,106	(19,337,022)	441,557,656	(1,594,152)	(231,965,178)
Differences between actual data and actuarial assumptions					
Projected benefit obligations related	(22,561,941)	(7,065,466)	(67,501,464)	15,827,000	26,821,856
Plan assets related	(63,896,745)	98,221,809	76,359,880	(178,636,090)	800,296,494
Total net actuarial losses (gains) (Notes 11. 4 and 11.7)	49,753,420	71,819,321	450,416,072	(164,403,242)	595,153,172

(a) The decrease in this caption in the period ended 31 December 2010, is mainly related to the Company's post-retirement benefit plans that were transferred to the Portuguese State.

As at 31 December 2012, the estimate of future undiscounted payments to be made by PT Comunicações related to salaries due to pre-retired and suspended employees and to expected contributions to the funds is as follows:

2013	2014 - 2015	2016 - 2017	More than 5 years	Total
		million euro		
134.9	253.2	178.8	353.6	920.5

PT Comunicações
Notes to Financial Statements (Continued)
As at 31 December 2012
(Amounts in Euro)

12. Related parties

12.1. Balances with shareholders and group companies

As at 31 December 2012 and 2011, the captions “Shareholders and group companies” included in current and non-current assets and in current liabilities respectively have the following composition:

	2012	2011
	Euro	
DEBIT BALANCES		
Non-Current		
Loans granted ^(a)	340,000,000	340,000,000
Total non-current	340,000,000	340,000,000
Current		
Accounts receivable from PT SGPS within tax consolidation ^(b)	—	39,993,766
Total current	—	39,993,766
Total debit balances with shareholders and group companies	340,000,000	379,993,766
CREDIT BALANCES		
Current		
Accounts payable from PT SGPS within tax consolidation ^(b)	1,607,803	—
Other	49,440	—
Total current (Note 12.3)	1,657,243	—
Total credit balances with shareholders and group companies	1,657,243	—

(a) The outstanding amount due as at 31 December 2012 relates to loans granted to TMN amounting to Euro 340,000,000, which were initially acquired in November 2010 in connection with the acquisition of this company, for an amount of Euro 500,000,000, of which an amount of Euro 160,000,000 was repaid in 2011 (Note 4 (b)).

(b) During the years ended as at 31 December 2012 and 2011, PT Comunicações reported tax losses that were used by PT SGPS consolidated tax, rather than being recognized as a gain in the Company’s financial statements. The accounts payable at 31 December 2012 correspond mainly to autonomous taxation. The accounts receivable at 31 December 2011 correspond mainly to amounts of PT Prime that were included in the Company’s balance sheet following the merger occurred in 2011, and include primarily the following amounts: (i) Euro 38,662,510 related to payments on accounts made in 2011 and that were recovered in 2012; (ii) Euro 3,006,791 received in 2012, under a program of tax incentives for investment (SIFIDE) regarding the years 2007 and 2010; and (iii) Euro 2,033,092 paid in 2012 regarding autonomous taxation.

12.2. Financial investments in subsidiaries and associated companies

As mentioned in the Introduction Note, Portugal Telecom is 100% held by PT Portugal which is fully held by PT SGPS. Consequently, all companies included in the Group were considered as PT Comunicações related parties, including not only its own subsidiaries and associates but also other subsidiaries of PT SGPS.

PT Comunicações
Notes to Financial Statements (Continued)
As at 31 December 2012
(Amounts in Euro)

12. Related parties (Continued)

As at 31 December 2012 and 2011, the detail of Portugal Telecom's financial investments in its subsidiaries and associated companies and the main financial information of these entities is detailed as follows (Notes 10, 21 and 26):

Company name	2012			2011				
	% held	Financial investments	Provision for financial investments	Share on net income	% held	Financial investments	Provision for financial investments	Share on net income
Euro								
SUBSIDIARIES:								
TMN	100.00%	7,253,097,184	—	117,781,680	100.00%	7,672,001,785	—	150,356,837
Janela Digital ^(a)	50.00%	2,048,674	—	(128,292)	50.00%	2,176,966	—	588,161
Infonet	90.00%	1,188,968	—	(111,958)	90.00%	1,352,255	—	51,328
PT Blueclip ^(b)	100.00%	47,803	—	(2,198)	—	—	—	—
PT Brasil, S.A. ("PT Brasil") ^(c)	0.01%	10,660	—	106	0.01%	11,059	—	1,288
PT-Sistemas de Informação ("PT-SI") ^(c)	0.10%	—	(1,006)	(3,015)	0.10%	2,191	—	2,434
PT Prestações	100.00%	—	(296,342)	(4,286)	100.00%	—	(292,057)	(19,974)
		<u>7,256,393,289</u>	<u>(297,348)</u>	<u>117,532,037</u>		<u>7,675,544,256</u>	<u>(292,057)</u>	<u>150,980,074</u>
ASSOCIATED COMPANIES:								
Multicert, SA ("Multicert")	20.00%	709,793	—	161,282	20.00%	665,709	—	101,609
Capital Criativo—SCR, S.A. ("Capital Criativo")	10.00%	64,702	—	3,320	10.00%	61,381	—	(59,615)
Tele Larm ^(d)	—	—	—	—	—	—	—	(263,032)
CTM ^(e)	3.00%	—	—	2,833,844	3.00%	5,067,871	—	2,507,757
		<u>774,495</u>	<u>—</u>	<u>2,998,446</u>		<u>5,794,961</u>	<u>—</u>	<u>2,286,719</u>
		<u>7,257,167,784</u>	<u>(297,348)</u>	<u>120,530,483</u>		<u>7,681,339,217</u>	<u>(292,057)</u>	<u>153,266,793</u>

(a) The 2012 and 2011 information does not correspond to figures of 31 December.

(b) This company was acquired in 2012 to PT SGPS.

(c) Portugal Telecom Group has a 100% stake in these companies.

(d) This company was liquidated in 2011 (Note 10).

(e) Portugal Telecom Group holds a total stake of 28% in this company. The investment in this company was classified as a non-current asset held for sale at 31 December 2012 (Note 10).

PT Comunicações
Notes to Financial Statements (Continued)
As at 31 December 2012
(Amounts in Euro)

12. Related parties (Continued)

In 2012 and 2011, the main financial information regarding the above entities, except for those which have no activity or are fully adjusted for, is as follows:

Company name	Headquarters	2012				
		Assets	Liabilities	Services rendered and sales	Net (Loss) Income	Shareholders' equity
Euro						
SUBSIDIARIES:						
TMN ^(a)	Av. Álvaro Pais, 2 1649-041 Lisboa Parque Tecnológico de Óbidos	8,241,316,756	988,219,572	1,153,310,003	117,781,680	7,253,097,184
Janela Digital ^(b)	Rua da Criatividade, Lote 6 2510-034 Óbidos	5,182,382	1,085,035	3,910,781	1,029,962	4,097,347
Infonet	Rua Castilho, 39, 12G 1250-068 Lisboa Av. Brigadeiro Faria de Lima, n.º 2277, 15.º	1,466,516	145,440	1,142,323	(124,398)	1,321,076
PT Brasil	1503 Jardim Paulistano S. Paulo—Brasil Taguspark—Parque da Ciência e Tecnologia	236,382,533	25,282,479	—	2,099,615	211,100,054
PT-SI ^(c)	Av. Jacques Delors, Edifícios Inovação III e IV 2740-122 Porto Salvo	69,907,667	60,884,381	110,995,705	(3,014,854)	9,023,286
PT Prestações ^(d)	Rua Andrade Corvo, n.º 6 1050-009 Lisboa	300,151,428	20,699,195	179,114	(4,286)	279,452,233
PT Blueclip	Av. Fontes Pereira de Melo, n.º 40 1050-122 Lisboa	50,506	2,703	—	(2,198)	47,803
ASSOCIATED COMPANIES:						
Multicert ^(e)	Estrada do Casal do Canas, Lote 6 2610-264 Alfragide	5,059,265	1,510,224	2,731,569	756,080	3,549,041
Capital Criativo ^(f)	Urbanização de Loures Business Park, EN 115, Lt. 5, 2660-515 Loures Edifício Telecentro	664,658	17,649	190,282	33,199	647,009
CTM	Ilha da Taipa Macau	268,583,983	99,587,914	456,240,787	94,428,628	168,996,069

PT Comunicações
Notes to Financial Statements (Continued)
As at 31 December 2012
(Amounts in Euro)

12. Related parties (Continued)

Company name	Headquarters	Assets	Liabilities	2011		Shareholders' equity
				Services rendered and sales Euro	Net (Loss) Income	
SUBSIDIARIES:						
TMN ^(a)	Av. Álvaro Pais, 2 1649-041 Lisboa	8,877,908,269	1,205,906,484	1,244,015,616	150,356,837	7,672,001,785
Janela Digital ^(b)	Parque Tecnológico de Óbidos Rua da Criatividade, Lote 6 2510-034 Óbidos	5,218,188	864,256	3,658,638	1,286,547	4,353,932
Infonet	Rua Castilho, 39, 12G 1250-068 Lisboa	1,677,852	175,347	1,433,741	57,031	1,502,505
PT Brasil	Av. Brigadeiro Faria de Lima, n.º 2277, 15.º 1503 Jardim Paulistano S. Paulo—Brasil	246,593,555	27,587,062	—	25,516,142	219,006,493
PT-SI ^(c)	Taguspark—Parque da Ciência e Tecnologia Av. Jacques Delors, Edifícios Inovação III e IV 2740-122 Porto Salvo	71,490,375	59,270,750	125,548,899	2,434,436	12,219,625
PT Prestações ^(d)	Rua Andrade Corvo, n.º 6 1050-009 Lisboa	300,351,901	71,953	149,639	(19,974)	300,279,948
ASSOCIATED COMPANIES:						
Multicert	Estrada do Casal do Canas, Lote 6 2610-264 Alfragide	4,655,955	1,327,341	3,097,806	566,896	3,328,613
Capital Criativo	Urbanização de Loures Business Park, EN 115, Lt. 5, 2660-515 Loures Edifício Telecentro	637,413	23,603	157,115	(168,099)	613,810
CTM	Ilha da Taipa Macau	263,515,660	94,586,628	322,115,352	83,518,694	168,929,032

(a) The Company's financial information was adjusted in order to reflect the impacts resulting from the purchase price allocation of this investment, which was concluded in 2011 and recognized retrospectively to the acquisition date, as mentioned above.

(b) The 2012 and 2011 information does not correspond to figures of 31 December.

(c) As of 31 December 2012 and 2011, shareholders' equity includes additional paid in capital amounting to Euro 10,028,970.

(d) As of 31 December 2012 and 2011, shareholders' equity includes additional paid in capital amounting to Euro 279,748,575 end Euro 300,572,005, respectively.

(e) Information reported as of 30 September 2012.

(f) Information reported as of 30 November 2012.

PT Comunicações
Notes to Financial Statements (Continued)
As at 31 December 2012
(Amounts in Euro)

12. Related parties (Continued)

12.3. Balances and transactions with related parties

Besides the receivables and payables included under the captions “Shareholders and group companies”, as detailed above (Note 12.1), the Company has other receivables and payables with related parties included in other captions. The nature and detail of the main balances with related parties as at 31 December 2012 and 2011 are as follows:

	2012			Total accounts receivable
	Shareholders and group companies	Accounts receivable and unbilled revenues	Other accounts receivable	
	Euro			
TMN	340,000,000	72,830,941	27,491,489	440,322,430
UNITEL SARL (“UNITEL”)	—	7,988,639	—	7,988,639
PT Pro, Serviços Administrativos e de Gestão Partilhados, SA (“PT Pro”) . . .	—	5,714,830	568	5,715,398
Páginas Amarelas, S.A. (“Páginas Amarelas”)	—	4,163,169	903,834	5,067,003
CST—Companhia Santomense Telecomunicações, SARL (“CST”)	—	4,966,063	—	4,966,063
Portugal Telecom Data Center, SA (“PT Data Center”)	—	4,134,813	—	4,134,813
PT Contact—Telemarketing e Serviços de Informação, SA (“PT Contact”) . . .	—	3,200,753	109	3,200,862
PT SI	—	786,919	1,882,137	2,669,056
Fibroglobal—Comunicações Electrónicas, SA (“Fibroglobal”)	—	1,966,391	603,272	2,569,663
PT Centro Corporativo S.A. (“PT CC”) . .	—	2,261,542	505	2,262,047
PT ACS	—	1,834,544	(37,364)	1,797,180
Portugal Telecom Inovação, SA (“PT Inovação”)	—	1,710,012	2,165	1,712,177
Other	—	4,007,301	272,928	4,280,229
	<u>340,000,000</u>	<u>115,565,917</u>	<u>31,119,643</u>	<u>486,685,560</u>

PT Comunicações
Notes to Financial Statements (Continued)
As at 31 December 2012
(Amounts in Euro)

12. Related parties (Continued)

	2011			
	Shareholders and group companies	Accounts receivable and unbilled revenues	Other accounts receivable	Total accounts receivable
	Euro			
TMN	340,000,000	81,795,373	14,955,794	436,751,167
PT SGPS	39,993,766	192,372	178,728	40,364,866
UNITEL	—	7,850,622	—	7,850,622
Páginas Amarelas	—	3,929,845	2,047,993	5,977,838
PT Contact	—	4,467,236	585	4,467,821
PT Pro	—	4,392,692	—	4,392,692
CST	—	3,556,960	—	3,556,960
PT ACS	—	3,342,401	—	3,342,401
PT SI	—	1,073,531	2,002,575	3,076,106
PT CC	—	2,136,821	8	2,136,829
PT Inovação	—	1,946,185	11,998	1,958,183
PT Data Center	—	1,413,751	—	1,413,751
Other	—	4,371,987	50,957	4,422,944
	379,993,766	120,469,776	19,248,638	519,712,180

As at 31 December 2012 and 2011, the nature and detail of the main credit balances with related parties are as follows:

	2012				
	Loans obtained (Note 22)	Shareholders and Group companies (Note 12.1)	Accounts payable and accrued expenses	Other accounts payable	Total accounts payable
	Euro				
PT Portugal	3,527,000,000	—	61,422,333	—	3,588,422,333
PT SGPS	117,962,274	1,607,803	1,804,520	127	121,374,724
PT Contact	—	—	42,615,164	7,446	42,622,610
PT PRO	—	—	24,541,904	5,193	24,547,097
TMN	—	41,582	15,554,866	2,930,466	18,526,914
PT SI	—	7,590	16,196,351	6,968	16,210,909
PT Sales	—	—	12,054,638	10,124	12,064,762
PT Inovação	—	—	11,472,188	9,464	11,481,652
PT CC	—	—	9,309,436	9,016	9,318,452
PT ACS	—	268	6,088,695	3,211,554	9,300,517
Páginas Amarelas	—	—	6,518,341	1,847	6,520,188
UNITEL	—	—	2,681,438	—	2,681,438
CST	—	—	1,884,940	—	1,884,940
Other	—	—	3,872,464	126,357	3,998,821
	3,644,962,274	1,657,243	216,017,278	6,318,562	3,868,955,357

PT Comunicações
Notes to Financial Statements (Continued)
As at 31 December 2012
(Amounts in Euro)

12. Related parties (Continued)

	2011			Total accounts payable
	Loans obtained (Note 22)	Accounts payable and accrued expenses	Other accounts payable	
	Euro			
PT Portugal	3,527,000,000	127,826,888	—	3,654,826,888
PT SGPS	590,123,358	21,544,848	13,606	611,681,812
TMN	—	31,818,064	7,203,460	39,021,524
PT Contact	—	46,474,419	6,492	46,480,911
PT PRO	—	21,923,576	1,178	21,924,754
PT Sales	—	18,852,521	27	18,852,548
PT SI	—	15,934,490	80,133	16,014,623
PT Inovação	—	15,501,144	1,035	15,502,179
Páginas Amarelas	—	11,012,789	1,610	11,014,399
PT CC	—	9,041,998	2,384	9,044,382
UNITEL	—	7,726,495	—	7,726,495
PT ACS	—	5,281,479	—	5,281,479
CVT	—	2,452,457	378	2,452,835
CST	—	2,383,942	—	2,383,942
Other	—	503,340	4,027,547	4,530,887
	<u>4,117,123,358</u>	<u>338,278,450</u>	<u>11,337,850</u>	<u>4,466,739,658</u>

PT Comunicações
Notes to Financial Statements (Continued)
As at 31 December 2012
(Amounts in Euro)

12. Related parties (Continued)

During the years ended 31 December 2012 and 2011, the nature and detail of the main transactions with related parties are as follows:

	2012						
	Sales and services rendered	Costs of services rendered	Supplies and external services	Wages and salaries ^(e)	Other operating income and gain	Other operating expenses and losses	Net interest expenses
	Euro						
TMN	164,965,708	(111,976,275)	(6,968,237)	4,752,819	30,984,510	(17,177)	527
UNITEL	10,345,303	(4,077,035)	—	—	170,011	(37,794)	—
CST	2,401,232	(1,206,169)	—	—	1,391,761	—	—
Páginas Amarelas	2,054,498	(26,423,673)	33,218	—	1,560	—	—
Timor Telecom	1,987,507	(3,019,038)	—	350,372	119,413	(48,286)	—
PT Contact	1,856,728	(1,039,335)	(66,361,944)	11,066,703	4,425,989	—	—
CVT	1,139,618	(8,243,991)	(129,642)	—	120	(9,242)	—
MTC	1,120,661	(543,470)	—	—	17,540	(7,835)	—
CV Multimédia	767,650	(13,143)	—	—	—	—	—
Vortal—Comércio Electrónico, Consultadoria e Multimédia, S.A.	653,768	—	(9,320)	—	145	—	—
Fibroglobal	459,448	—	—	55,314	302	—	(10)
PT Inovação	371,134	(1,003,497)	(6,938,224)	9,349,102	107,125	—	—
Fundação PT	330,305	—	7,175	1,505,558	217,566	(25,772)	—
PT PRO	304,815	(6,505,698)	(33,130,277)	17,053,348	16,413	—	—
Multitel—Serviços de Telecomunicações, Lda.	283,883	(427,458)	(95,483)	—	1,931	(6,404)	—
PT SI	173,205	(9,599,102)	(20,815,238)	1,890,084	1,336,637	—	—
PT CC	55,639	—	(38,758,871)	8,952,942	1,074,208	—	—
PT Compras	21,988	—	244	1,818,315	326,415	—	—
Siresp	12,242	—	(172)	—	1,141,565	—	—
PT Sales	7,519	—	(49,151,733)	3,226,378	64,174	—	—
PT II	6,898	—	225	1,932,968	150,946	(417)	—
PT SGPS	691	—	—	90,322	342,230	—	(14,332,391)
PT Portugal	—	—	—	684,964	—	—	(144,625,092)
PT ACS	—	—	(83,123)	(3,614,777)	72,300	—	—
Other	573,657	(926,554)	(729,309)	616,015	65,370	(83,477)	—
	189,894,097	(175,004,438)	(223,130,711)	59,730,427	42,028,231	(236,404)	(158,956,966)

PT Comunicações
Notes to Financial Statements (Continued)
As at 31 December 2012
(Amounts in Euro)

12. Related parties (Continued)

	2011						Net interest expenses
	Sales and services rendered	Costs of services rendered	Supplies and external services	Wages and salaries ^(a)	Other operating income and gain	Other operating expenses and losses	
	Euro						
TMN	139,594,540	(42,346,335)	(7,271,468)	5,047,677	13,470,134	11,699	21,267,282
UNITEL	10,083,130	(6,681,417)	—	—	30,591	(48,789)	—
CST	2,275,530	(2,714,037)	—	—	1,065,913	(33,936)	—
Páginas Amarelas	2,088,056	(35,946,836)	(41,757)	—	721	—	—
Timor Telecom	1,996,550	(1,984,290)	—	214,002	362,421	(258,316)	—
PT Contact	1,935,293	(1,183,302)	(72,736,143)	10,682,291	4,444,146	—	—
PT ACS	1,468,884	—	(36,013)	(4,022,151)	90,103	—	—
CVT	1,165,586	(10,323,255)	—	—	72	(80)	—
MTC	960,633	(372,083)	—	—	8,607	(5,978)	—
CV Multimédia	699,683	(1,601)	—	—	—	—	—
PT Inovação	604,015	(509,674)	(6,358,532)	9,565,570	127,899	—	—
Infonet	564,603	(162,050)	—	—	—	—	—
Vortal—Comércio Electrónico, Consultadoria e Multimédia, S.A.	533,598	(520)	(10,730)	—	107	—	—
Fundação PT	362,269	—	19	1,317,614	200,884	—	—
PT SI	284,417	(5,517,124)	(28,013,861)	1,776,398	1,613,277	—	—
PT PRO	248,288	(1,094,548)	(35,637,309)	17,848,926	(16,125)	402	—
PT CC	112,815	—	(38,007,047)	6,982,030	1,067,443	—	—
PT Compras	33,388	—	—	1,856,951	318,897	—	—
Siresp	13,241	—	—	—	1,099,251	—	—
PT Sales	11,270	—	(51,720,718)	3,403,324	63,891	—	—
PT SGPS	9,753	—	—	153,436	330,288	(2,587)	(27,687,861)
PT II	6,872	—	225	2,791,730	146,787	—	—
PT Portugal	—	—	—	—	—	—	(149,302,888)
Other	1,304,807	(1,013,561)	(668,115)	757,758	108,069	(4,500,119)	89
	166,357,221	(109,850,633)	(240,501,449)	58,375,556	24,533,376	(4,837,704)	(155,723,378)

(a) Transactions with related parties included under this caption correspond primarily to gains resulting from amounts charged to other Group entities related to the Company's employees which are currently working in those other entities.

12.4. Other information

Remunerations of the Company's executive and non-executive board members in 2012 and 2011 were as follows:

	2012	2011
	Euro	
Board of Directors		
Fixed remuneration	—	635,236
Variable remuneration	—	384,875
Accountant		
Statutory audit fees	50,000	63,970
Audit related services fees	7,000	10,000
	57,000	1,094,081

PT Comunicações
Notes to Financial Statements (Continued)
As at 31 December 2012
(Amounts in Euro)

12. Related parties (Continued)

In 2012, the remunerations of Board members were fully supported by PT Portugal. In 2011, no compensation was given to some Board members, since they are paid for performing functions in other PT Group companies.

13. Deferrals

As at 31 December 2012 and 2011, this caption consisted of the following:

	2012	2011
	Euro	
PREPAID EXPENSES		
Current		
Interest and other financial expenses	7,458,782	3,829,240
Direct costs	7,242,623	5,339,160
Maintenance	1,117,278	1,850,413
Telephone directories	726,752	2,045,786
Other	1,446,227	955,208
Total current	17,991,662	14,019,807
Total prepaid expenses	17,991,662	14,019,807
DEFERRED INCOME		
Non-current		
Transfer of rights of telecom infrastructure use	665,145	1,530,022
Total non-current	665,145	1,530,022
Current		
Penalties imposed to customers relating to violations of contracts ^(a)	45,827,448	19,774,129
Advance billing ^(b)	19,375,671	31,452,046
Transfer of rights of telecom infrastructure use	3,583,034	4,763,484
Assignment of user rights for submarine cable stations	1,678,943	2,629,996
Other	3,853,817	6,954,057
Total current	74,318,913	65,573,712
Total deferred income	74,984,058	67,103,734

(a) The increase in this caption relates to penalties for violation of contracts by customers of the Pay-tv service and certain irregularities undertaken by ZON regarding the portability of customers.

(b) The reduction in this caption reflects primarily the recognition in 2012 of a gain related to the DTT service, amounting to Euro 11 million, which was recorded under this caption as at 31 December 2011.

PT Comunicações
Notes to Financial Statements (Continued)
As at 31 December 2012
(Amounts in Euro)

14. Other financial assets and liabilities

As at 31 December 2012 and 2011, these captions consist of the following:

	<u>2012</u>	<u>2011</u>
	Euro	
OTHER FINANCIAL ASSETS		
Non-Current		
Accounts receivable—trade (Note 17)	365,032	2,118,135
Other	8,599	510,830
Total non-current	<u>373,631</u>	<u>2,628,965</u>
Total other financial assets	<u>373,631</u>	<u>2,628,965</u>

15. Income taxes

15.1. Introduction

As from 1 January 2012, following a change in Portuguese tax legislation occurred in December 2011, most companies are subject to Corporate Income Tax at a base rate of 25%, increased (1) up to a maximum of 1.5% of taxable income through a municipal tax, and (2) by a state surcharge levied at the rate of 3.0% on taxable income between Euro 1.5 million and Euro 10.0 million (Euro 7.5 million as from 1 January 2013, following a change in Portuguese tax legislation occurred in December 2012) and at the rate of 5.0% on taxable income in excess of Euro 10.0 million (Euro 7.5 million as from 1 January 2013).

As the Company reported tax losses for both years ended 31 December 2012 and 2011, neither the 1.5% municipal tax nor the state taxes are applicable. Consequently, and based on its expectations regarding future taxable results, PT Comunicações will continue to use the 25% tax rate for purposes of computing deferred taxes.

The Company's income taxes are computed based on the tax rate mentioned above and are determined on the basis of profit before-tax adjusted in accordance with tax legislation.

The Company is part of the Special Taxation Regime for Groups of Companies (RETGS) whose dominant company is PT SGPS, so the income tax estimate and deductions made by third parties are recorded on the balance sheet as accounts payable and receivable of PT SGPS.

In accordance with the prevailing legislation, taxation returns are subject to review and correction by the tax authorities during a period of four years (five years for Social Security, Security), except where there have been tax losses, fiscal benefits have been granted, or there are inspections, claims or challenges pending; in such cases, these periods may be extended or suspended, depending on the circumstances. Based upon the information supplied by its tax advisory services, the Board of Directors considers that any corrections to the tax returns that might result from reviews carried out by the tax authorities will not have a significant effect on the financial statements as at 31 December 2012, considering the provisions recorded and the current expectations of settlement regarding tax contingencies described in Note 21.

PT Comunicações
Notes to Financial Statements (Continued)
As at 31 December 2012
(Amounts in Euro)

15. Income taxes (Continued)

15.2. Deferred taxes

As mentioned in Note 3.10, deferred tax assets are recognised to the extent that it is reasonably likely that taxable income will be available against which deductible temporary differences can be used, or when there are deferred tax liabilities the reversal of which is expected in the same period in which the deferred tax assets reverse. PT Comunicações believes that deferred tax assets recorded in the Balance Sheet are recoverable either through its future taxable income, based on its budget for the year 2013 and projections of results for the subsequent years adjusted for differences between the accounting and taxable earnings and for certain financial operations to be undertaken in the future, or through the reversal of deferred tax liabilities.

In assessing income tax expenses for the year, in addition to the current tax determined on the basis of profit before-tax adjusted in accordance with tax legislation, the effects of temporary differences between income before tax and taxable earnings arising in the given year or in previous years is also considered.

Movements occurred in deferred tax assets during the years ended 31 December 2012 and 2011 were as follows:

	2012						Total
	Post retirement benefits	Additional contribution to pension funds	Impairment of accounts receivable	Depreciation and amortisation of tangible assets	Other provision and adjustments	Other temporary differences	
	Euro						
Opening balance	290,296,802	4,684,889	—	9,732,610	2,330,385	5,085,030	312,129,716
Increases (reductions)							
Net income	(17,913,259)	(4,684,889)	10,276,194	34,248	(123,161)	2,136,309	(10,274,558)
Shareholders' equity (Note 20.4)	12,438,354	—	—	—	—	—	12,438,354
Closing balance	284,821,897	—	10,276,194	9,766,858	2,207,224	7,221,339	314,293,512
	2011						
	Post retirement benefits	Additional contribution to pension funds	Depreciation and amortisation of tangible	Other provision and adjustments	Other temporary differences	Total	
	Euro						
Opening balance	552,228,264	11,378,964	6,148,242	2,712,366	3,611,366	576,079,202	
PT Prime merger	85,861	—	832,905	—	12,420	931,186	
Increases (reductions)							
Net income	(279,966,358)	(6,694,075)	2,850,731	(381,981)	1,461,521	(282,730,162)	
Shareholders' equity (Note 20.4)	17,957,210	—	—	—	—	17,957,210	
Change in the statutory tax rate							
Net income	(5,796)	—	(99,268)	—	(277)	(105,341)	
Shareholders' equity (Note 20.4)	(2,379)	—	—	—	—	(2,379)	
Closing balance	290,296,802	4,684,889	9,732,610	2,330,385	5,085,030	312,129,716	

PT Comunicações
Notes to Financial Statements (Continued)
As at 31 December 2012
(Amounts in Euro)

15. Income taxes (Continued)

Movements occurred in deferred tax liabilities during the years ended 31 December 2012 and 2011 were as follows:

	2012			Total
	Assets revaluation	Earnings not attributed to associated companies	Capital gain with deferred taxation	
	Euro			
Opening balance	182,457,075	1,131,131	1,341,723	184,929,929
Increases (reductions)				
Net income	(10,937,588)	33,262	(288,486)	(11,192,812)
Shareholders' equity (Notes 20.5)	—	(30,434)	—	(30,434)
Closing balance	171,519,487	1,133,959	1,053,237	173,706,683
	2011			
	Assets revaluation	Earnings not attributed to associated companies	Capital gain with deferred taxation	Total
	Euro			
Opening balance	228,404,885	1,020,367	1,622,117	231,047,369
Increases (reductions)				
Net income	(14,405,920)	56,930	(288,485)	(14,637,475)
Shareholders' equity (Note 20.5 and 20.6)	(31,541,890)	30,103	—	(31,511,787)
Other				
Net income	—	—	8,091	8,091
Shareholders' equity (Note 20.5)	—	23,731	—	23,731
Closing balance	182,457,075	1,131,131	1,341,723	184,929,929

PT Comunicações
Notes to Financial Statements (Continued)
As at 31 December 2012
(Amounts in Euro)

15. Income taxes (Continued)

15.3. Tax rate reconciliation

In 2012 and 2011, the reconciliation between the expected tax computed by applying the nominal tax rate to income before taxes and the total income tax is as follows:

	2012	2011
	Euro	
Income before taxes	(87,769,916)	(107,220,185)
Nominal tax rate	25.00%	25.00%
Expected tax	(21,942,479)	(26,805,046)
Permanent differences ^(a)	(28,719,166)	(34,457,660)
Surplus of prior year accrued income tax	(1,859,485)	(8,106,042)
Tax loss used in connection with RETGS ^(b)	170,121,916	217,045,018
Write-off / Derecognition of deferred tax assets ^(c)	(113,579,000)	113,579,000
Collection adjustments	1,909,491	2,033,092
Effect of the change in tax rate	—	107,720
Other	(6,799,524)	(1,262,914)
	(868,247)	262,133,168
Income tax		
Income tax-current	50,007	(6,072,951)
Deferred tax	(918,254)	268,206,119
	(868,247)	262,133,168

(a) Permanent differences are as follows:

	2012	2011
	Euro	
Equity method of accounting (Note 26) ⁽ⁱ⁾	(117,696,638)	(150,759,036)
Provisions and adjustments not deductible for tax purposes	7,495,389	8,306,555
Write-off of accounts receivable	743,000	3,318,630
Recognition of capital gains and losses ⁽ⁱⁱ⁾	(660,323)	4,519,462
Tax benefits	(3,185,478)	(3,323,409)
Other	(1,572,614)	107,158
	(114,876,664)	(137,830,640)
Nominal tax rate	25.00%	25.00%
	(28,719,166)	(34,457,660)

(i) Except for the Company's share in the earnings of CTM, for which we recognize a deferred tax liability, gains and losses in affiliated companies represent permanent differences.

(ii) This caption refers to the difference between the accounting capital gains and losses and corresponding tax capital gains and losses related to the disposal of fixed assets.

(b) This caption corresponds to the taxable loss computed in both years by the Company in accordance with Income Tax legislation. In accordance with the fiscal policy set by Portugal Telecom Group, the gain related to the use of these tax losses has been recorded at the group level in PT SGPS' financial statements.

(c) Based on its expectation regarding its individual tax results, the Company in 2011 wrote off a portion of deferred tax assets related to post-retirement benefits that would have been used in 2012, since it believes that the referred tax results will not be enough to allow the use of these deferred tax assets. In 2012, the Company incurred in the tax costs associated with the deferred taxes derecognized in 2011, which therefore contributed to the tax loss generated in the year 2012, as detailed in the table above, and led to the permanent difference presented in 2012.

PT Comunicações
Notes to Financial Statements (Continued)
As at 31 December 2012
(Amounts in Euro)

15. Income taxes (Continued)

15.4. Other information

In connection with the Law 40/2005, of August 3, which approved the program SIFIDE—Tax Incentives on Research and Development System, the Company filed in 2012 the application related to the year 2011, amounting to Euro 1,593,543.

Under the law 10/2009 of March 10, which approved the RFAI—Tax Regime to Support Investment, the Company included in its 2011 income tax declaration form a tax benefit amounting to Euro 7,355,416, related to the significant investments made on the creation of new generation broadband networks.

16. Inventories

As at 31 December 2012 and 2011, this caption consists of the following:

	2012			2011		
	Gross value	Impairment losses	Net value	Gross value	Impairment Losses	Net value
	Euro					
Goods	39,253,567	(10,310,480)	28,943,087	47,441,728	(15,851,031)	31,590,697
Raw materials and consumables	22,264,647	(1,574,336)	20,690,311	24,094,933	(2,389,398)	21,705,535
Work in progress	(723,425)	—	(723,425)	789,102	—	789,102
	60,794,789	(11,884,816)	48,909,973	72,325,763	(18,240,429)	54,085,334

The cost of products sold was determined as follows:

	2012			2011		
	Goods	Materials	Total	Goods	Materials	Total
	Euro					
Opening balance	47,441,728	24,094,933	71,536,661	28,293,441	28,265,789	56,559,230
PT Prime merger	—	—	—	631,296	56,266	687,562
Purchases	109,250,244	52,331,420	161,581,664	136,772,709	94,021,593	230,794,302
Adjustments ^(a)	(91,569,563)	(48,391,866)	(139,961,429)	(85,732,105)	(91,955,597)	(177,687,702)
Closing balance	39,253,567	22,264,647	61,518,214	47,441,728	24,094,933	71,536,661
Costs of products sold	25,868,842	5,769,840	31,638,682	32,523,613	6,293,118	38,816,731

(a) Adjustments to inventories refer mainly to transfers to fixed assets, upon the installation of terminal equipment leased to customers and materials installed in building network infrastructures.

The production variation in 2012 and 2011 is as follows:

	2012	2011
	Euro	
Closing balance	(723,425)	789,102
PT Prime merger	—	(1,044,723)
Opening balance	(789,102)	(435,928)
Production variation	(1,512,527)	(691,549)

PT Comunicações
Notes to Financial Statements (Continued)
As at 31 December 2012
(Amounts in Euro)

16. Inventories (Continued)

In the years ended as at 31 December 2012 and 2011, the evolution of accumulated impairment losses relative to inventories was as follows:

	2012			2011		
	Goods	Materials	Total	Goods	Materials	Total
	Euro					
Opening balance	15,851,031	2,389,398	18,240,429	21,504,053	3,359,680	24,863,733
PT Prime merger	—	—	—	38,424	8,654	47,078
Increases	3,716,474	—	3,716,474	1,644,474	—	1,644,474
Reversals	(6,468,289)	(815,062)	(7,283,351)	(7,335,920)	(978,936)	(8,314,856)
Utilizations	(2,788,736)	—	(2,788,736)	—	—	—
Closing balance	10,310,480	1,574,336	11,884,816	15,851,031	2,389,398	18,240,429

17. Accounts receivables and unbilled revenues

As at 31 December 2012 and 2011, this caption consists of:

	2012			2011		
	Gross value	Impairment losses	Net value	Gross value	Impairment losses	Net value
	Euro					
Trade accounts receivable—current assets	624,272,775	(154,117,676)	470,155,099	689,676,520	(177,563,099)	512,113,421
Trade accounts receivable—non-current assets (Note 14)	365,032	—	365,032	2,118,135	—	2,118,135
Accounts receivable	624,637,807	(154,117,676)	470,520,131	691,794,655	(177,563,099)	514,231,556
Unbilled revenues	64,005,319	—	64,005,319	121,039,215	—	121,039,215
	688,643,126	(154,117,676)	534,525,450	812,833,870	(177,563,099)	635,270,771

In the years ended as at 31 December 2012 and 2011, the evolution of accumulated impairment losses related to accounts receivable was as follows:

	2012	2011
	Euro	
Opening balance	177,563,099	174,901,870
PT Prime merger	—	19,332,326
Reti merger	1,953	—
Increases (reversals)	25,750,763	13,692,613
Utilizations ^(a)	(49,198,139)	(30,363,710)
Closing balance	154,117,676	177,563,099

(a) This caption corresponds to the write-off of receivables that were previously fully adjusted for through the use of accumulated impairment losses.

The Company is exposed to the credit risk arising from the possibility that a third party does not fulfil its contractual obligations, resulting in a financial loss. The credit risk is primarily related to accounts receivable from services provided to customers and is monitored regularly with the following objectives: (a) limit the credit granted to customers, considering their profile and aging of receivables; (b) monitor the evolution of the credit level granted; (c) make regular reviews of the receivables recoverability;

PT Comunicações
Notes to Financial Statements (Continued)
As at 31 December 2012
(Amounts in Euro)

17. Accounts receivables and unbilled revenues (Continued)

(d) analysis of market risk where the customer is located. The Company is not exposed to any significant credit risk related to a particular customer, to the extent that its receivables arise from a large number of customers.

As at 31 December 2012 and 2011, the aging of receivables, net of impairment losses, was as follows:

	2012			2011		
	Accounts receivable from group companies	Accounts receivable from other companies	Total	Accounts receivable from group Companies	Accounts receivable from other companies	Total
	Euro					
Unexpired balance . . .	69,799,276	200,206,525	270,005,801	73,143,468	213,538,611	286,682,079
Expired balance						
0 - 60 days	21,946,132	59,967,759	81,913,891	8,463,263	89,572,301	98,035,564
60 - 90 days	1,523,605	13,832,752	15,356,357	1,232,515	15,819,724	17,052,239
90 - 180 days	3,633,891	25,682,526	29,316,417	3,958,112	30,095,322	34,053,434
180 - 360 days	5,089,602	29,449,088	34,538,690	2,093,566	26,249,083	28,342,649
360 - 720 days	1,457,161	22,052,724	23,509,885	1,570,134	17,707,583	19,277,717
More than 720 days	781,305	15,097,785	15,879,090	932,787	29,855,087	30,787,874
Accounts receivable . . .	104,230,972	366,289,159	470,520,131	91,393,845	422,837,711	514,231,556

Some of the accounts receivable with a higher aging relate to penalties for contracts violation imposed to customers, the revenues of which were deferred, as mentioned in Note 13.

18. State and other public entities

As at 31 December 2012 and 2011, the balances with these entities were as follows:

	2012		2011	
	Debit balances	Credit balances	Debit balances	Credit balances
	Euro			
Value added tax ^(a)	150,458	18,247,876	—	10,284,747
Personnel income taxes	—	12,638,888	—	7,588,954
Social security taxes	—	7,518,077	—	7,639,595
Municipality taxes	—	431,181	—	532,620
Corporate income taxes	—	5,533	—	—
Other taxes	43,294	2,998	230,428	7,395
	193,752	38,844,553	230,428	26,053,311

(a) As at 31 December 2012, this caption includes Value Added Tax payable regarding the months of November and December, amounting to Euro 7,181,420 and Euro 11,066,456, respectively. As at 31 December 2011, this caption includes Value Added Tax payable regarding the months of November and December, amounting to Euro 3,170,881 and Euro 7,127,028, respectively, reduced by a receivables refund amounting to Euro 13,162.

PT Comunicações
Notes to Financial Statements (Continued)
As at 31 December 2012
(Amounts in Euro)

19. Other accounts receivable and payable

As at 31 December 2012 and 2011, these captions consisted of the following:

	2012	2011
	Euro	
OTHER ACCOUNTS RECEIVABLE		
Current		
Group companies ^(a)	27,865,224	14,145,545
Several charges ^(b)	15,106,226	14,993,502
SNS—Comparticipação no Plano de Saúde ^(c)	8,225,736	8,711,396
Personnel	2,968,286	3,186,983
European Community subsidies	49,857	1,197,086
Other accounts receivable ^(d)	71,918,438	10,988,586
Total current	126,133,767	53,223,098
Accumulated impairment losses	(8,245,012)	(8,721,353)
Total other accounts receivable	117,888,755	44,501,745
OTHER ACCOUNTS PAYABLE		
Current		
PT ACS	2,327,116	4,526,317
Personnel	829,894	550,564
Group companies	15,942	32,586
Other accounts payable ^(e)	11,783,064	44,633,611
Total current	14,956,016	49,743,078

(a) In the years ended 31 December 2012 and 2011, this caption corresponds mainly to accrued interest in connection with loans granted to affiliated companies, amounting to Euro 27,440,391 and Euro 13,380,962, respectively, which relate mainly to the loans granted to TMN (Note 12).

(b) This caption includes mainly equipment's sale to occasional customers.

(c) The balances related to Serviço Nacional de Saúde correspond to the amount receivable by the Company regarding the State co-participation in the costs of healthcare plan.

(d) The increase in this caption reflects mainly a gain of approximately Euro 60 million (Note 31) recorded in 2012 related to a net compensation receivable from the Portuguese State for prior years costs supported by PT Comunicações with the universal service obligation under the Concession Agreement, in accordance with Law 66/2012.

(e) The change in this caption is primarily explained by: (i) a reduction in the present value of the outstanding future commitments assumed under the Digital Terrestrial Television license, which amounted to Euro 2.9 million and 20.8 million at 31 December 2012 and 2011, respectively; and (ii) an amount of Euro 14.9 million paid to PT Prestações in 2012 that was outstanding as at 31 December 2011, in connection with a transfer of receivables from public entities to this company.

During the years ended 31 December 2012 and 2011, the evolution in accumulated impairment losses related to accounts receivable was as follows:

	2012	2011
	Euro	
Opening balance	8,721,353	8,711,396
Increases	9,319	9,957
Reversals	(485,660)	—
Closing balance	8,245,012	8,721,353

PT Comunicações
Notes to Financial Statements (Continued)
As at 31 December 2012
(Amounts in Euro)

20. Shareholders' equity

20.1. Share capital

As at 31 December 2012 and 2011, the Company's share capital was fully paid and amounted to Euro 1,150,000,000 and was represented by 1,150,000,000 nominal shares (Note 35), with a nominal value of 1 Euro each. As at 31 December 2012 and 2011, the entirety of the Company's share capital was held by PT Portugal.

In 2011, as approved by the General Shareholders Meeting held on 30 September 2011, the Company carried out a share capital increase amounting to Euro 1,598,500,000, through the increase in the nominal value of each share. The Company also approved a share capital reduction of Euro 1,598,500,000, with the purpose of offsetting accumulated losses and negative fair value reserves, through the decrease in the nominal value of each share, of which Euro 899,496,127 was transferred to retained earnings and Euro 699,003,873 (Note 20.4) was transferred to other reserves.

20.2. Other shareholders' equity instruments

This caption corresponds to additional paid in capital contributions granted by PT Portugal, which do not bear interest and have no reimbursement term defined. In accordance with applicable law, reimbursement may be made only if, after payment, shareholders' equity is greater than the sum of capital, legal reserves and unrealised revaluation reserves.

In 2011, as approved by the General Shareholders Meeting held on 30 September, the paid in capital contributions were reimbursed to the shareholder in the amount of Euro 1,598,500,000.

20.3. Legal reserve

Portuguese law provides that at least 5% of annual profits must be appropriated to a legal reserve until this reserve equals the minimum requirement of 20% of share capital. This reserve is not available for distribution to shareholders but may be capitalized or used to absorb losses, once all other reserves and retained earnings have been exhausted.

20.4. Other reserves

During the years ended 31 December 2012 and 2011, the movements under this caption were as follows:

	<u>Net actuarial losses</u>	<u>Free reserves</u>	<u>Total</u>
		Euro	
Balance as at 1 January 2011	(338,105,921)	—	(338,105,921)
Actuarial losses			
Base (Note 11.7)	(71,819,321)	—	(71,819,321)
Tax effect (Note 15)	17,954,831	—	17,954,831
Share capital reduction (Note 20.1)	—	699,003,873	699,003,873
Balance as at 31 December 2011	(391,970,411)	699,003,873	307,033,462
Actuarial losses			
Base (Note 11.7)	(49,753,420)	—	(49,753,420)
Tax effect (Note 15)	12,438,354	—	12,438,354
Balance as at 31 December 2012	(429,285,477)	699,003,873	269,718,396

PT Comunicações
Notes to Financial Statements (Continued)
As at 31 December 2012
(Amounts in Euro)

20. Shareholders' equity (Continued)

20.5. Adjustments to financial assets

During the years ended 31 December 2012 and 2011, the movements under this caption were as follows:

	Unpaid dividends	Foreign currency exchange differences ^(a)	Other changes in shareholders' equity ^(b)	Total
	Euro			
Balance as at 1 January 2011	1,849,748	(1,229,588)	(165,454)	454,706
Equity method	—	(229,681,493)	(201,228)	(229,882,721)
Dividends not received from subsidiaries and associated companies	23,582,446	—	—	23,582,446
Liquidation of Tele Larm	—	—	6,603	6,603
Liquidation of PT Ásia	—	(49,032)	(440,775)	(489,807)
Deferred taxes (Note 15.2)	—	(53,834)	—	(53,834)
Balance as at 31 December 2011	25,432,194	(231,013,947)	(800,854)	(206,382,607)
Equity method	—	(350,270,498)	48,931,770	(301,338,728)
Dividends not received from subsidiaries and associated companies	50,868,659	—	—	50,868,659
Deferred taxes (Note 15.2)	—	30,434	—	30,434
Balance as at 31 December 2012	76,300,853	(581,254,011)	48,130,916	(456,822,242)

(a) The foreign currency exchange differences determined following the application of the equity method of accounting are related to the update of financial investment in Oi, which is indirectly owned through the affiliated company TMN.

(b) In 2012, other changes in shareholders' equity resulting from the equity method of accounting include primarily a gain recorded by Bratel Brasil (a company of PT Group that holds the investment in Oi Group and is held indirectly by TMN), amounting to Euro 49 million, corresponding to the impact of a corporate restructuring undertaken by the Oi Group in March 2012.

Movements related to the equity method of accounting were recorded under the following captions:

	2012	2011
	Euro	
Investments in subsidiaries and associated companies (Note 10) . . .	(301,338,547)	(229,883,184)
Provision for negative financial investments (Note 21)	(181)	463
	(301,338,728)	(229,882,721)

PT Comunicações
Notes to Financial Statements (Continued)
As at 31 December 2012
(Amounts in Euro)

20. Shareholders' equity (Continued)

20.6. Revaluation surplus

During the years ended 31 December 2012 and 2011, the movements under this caption were as follows:

	2012	2011
	Euro	
Opening balance	623,874,447	763,950,232
Revaluation of assets		
Base (Note 6.2)	—	(126,167,563)
Tax effect (Note 15.2)	—	31,541,890
Realization of revaluation surplus		
Base	(45,768,002)	(59,856,032)
Tax effect	10,937,589	14,405,920
Closing balance	589,044,034	623,874,447

In accordance with the applicable legislation and the accounting practices used in Portugal, the revaluation reserves cannot be distributed to shareholders; they can only be used, under certain circumstances and in accordance with Portuguese legislation, for future capital increases.

The revaluation reserves recognized under this caption are related to both (1) assets measured in accordance with the revaluation model, and also (Note 6.2) (2) other assets revalued previously, for which the Company, in connection with the adoption of SNC and as permitted by NCRF 3, adopted the cost model. The Company decided to include both of these revaluation reserves under this caption as they are both non-distributable to shareholders, as mentioned above.

During the year ended 31 December 2011, as mentioned in Note 6.2, the Company performed a new revaluation of its real estate properties and telecommunication infrastructure, having reduced the revaluation surplus recorded in shareholders' equity by an amount of Euro 126,167,563 (Note 6.2), net of the related tax effect amounting to Euro 31,541,890 (Note 15.2).

Annually, PT Comunicações transfers to retained earnings the revaluation reserve realized in the year, primarily through the depreciation of the asset that originated these reserves. The amounts transferred during the years ended 31 December 2012 and 2011, net of the corresponding tax effects, amounted to Euro 34,830,413 and Euro 45,450,112, respectively.

20.7. Other shareholders' equity

PT Comunicações recognises under this caption subsidies associated with the acquisition or production of non-current assets (investment subsidies), which were entirely received and are non-refundable, where the Company is not under obligation to comply with conditions associated with the subsidy.

These subsidies are subsequently recognized in earnings during the useful lives of the related assets for which those subsidies were granted. The Company recognized gains amounting to Euro 2,997,997 in 2012 and Euro 3,008,528 in 2011 (Note 31). The balance of this caption corresponds to the remaining amount of subsidies that have not yet been recognized in earnings.

20.8. Application of earnings

In 2011, as approved by the General Shareholders Meeting held on 25 March 2011, the negative net income of 2010, in the amount of Euro 138,658,825 was entirely transferred to the caption "Retained earnings".

PT Comunicações
Notes to Financial Statements (Continued)
As at 31 December 2012
(Amounts in Euro)

20. Shareholders' equity (Continued)

In 2012, as approved by the General Shareholders Meeting held on 29 March 2012, the negative net income of 2011, in the amount of Euro 369,353,353 was entirely transferred to the caption "Retained earnings".

21. Provisions, contingent liabilities and contingent assets

21.1. Movements occurred in provisions

During the years ended 31 December 2012 and 2011, the movements in provisions were as follows:

	2012				
	Tax claims	Other litigation	Provision for negative financial investments (Note 12)	Other provisions	Total
	Euro				
Opening balance	14,629,879	9,674,288	292,057	1,162,606	25,758,830
Increases	9,079,743	1,601,337	5,291	1,113,060	11,799,431
Reductions	(2,004,714)	(1,600,632)	—	(6,984)	(3,612,330)
Utilizations	(6,796,906)	—	—	(2,207,442)	(9,004,348)
Closing balance	14,908,002	9,674,993	297,348	61,240	24,941,583
Current	14,908,002	9,674,993	—	61,240	24,644,235
Non-current	—	—	297,348	—	297,348

	2011				
	Tax claims	Other litigation	Provision for negative financial investments (Note 12)	Other provisions	Total
	Euro				
Opening balance	6,326,740	9,898,194	272,635	4,962,258	21,459,827
Prime merger	301,743	220,014	—	—	521,757
Increases	8,859,146	1,485,770	19,974	—	10,364,890
Reductions	(857,750)	(991,688)	(463)	(27,922)	(1,877,823)
Utilizations	—	(938,002)	—	(3,771,730)	(4,709,732)
Liquidation of PT Ásia	—	—	(89)	—	(89)
Closing balance	14,629,879	9,674,288	292,057	1,162,606	25,758,830
Current	14,629,879	9,674,288	—	1,162,606	25,466,773
Non-current	—	—	292,057	—	292,057

21.2. Claims and legal proceedings

a) Proceedings with probable losses

Provisions for tax claims and legal proceedings are related to liabilities arising from legal proceedings against the Company, and are computed based on the advice of PT Comunicações' tax and legal advisors.

PT Comunicações
Notes to Financial Statements (Continued)
As at 31 December 2012
(Amounts in Euro)

21. Provisions, contingent liabilities and contingent assets (Continued)

As at 31 December 2012 and 2011, there were several legal proceedings and tax contingencies which, in accordance with “NCRF 21 Provisions, Contingent Liabilities and Contingent Assets” (“NCRF 21”) and based on the opinion of the Company’s internal and external tax and legal counsels, were considered as probable losses, since the Company considered probable the outflow of resources to settle the obligation. The nature of these claims is as follows:

	2012	2011
	Euro	
Legal proceedings		
Civil contingencies	3,321,484	3,288,009
Labor contingencies	2,504,227	2,857,219
Other contingencies	3,849,282	3,529,060
	9,674,993	9,674,288
Tax contingencies	14,908,002	14,629,879
	24,582,995	24,304,167

Set forth below are several tax claims assessed as constituting a probable loss, namely related to a portion of the VAT and IRC tax assessments in regard to the years 1997 and 1998 of Marconi and 1999 of Portugal Telecom, S.A., and the years 2002 to 2011 of PT Comunicações, among others, the Company has recorded a provision amounting to Euro 14,908,002 in 2012, including tax and interest. However, the Company is contesting these claims with the tax authorities.

b) Proceedings with possible losses

As at 31 December 2012 and 2011, the Company, in accordance with the definitions of NCRF 21 and based on the advice of its internal and external tax and legal counsels, had classified several claims and legal proceedings and tax contingencies as proceedings with possible losses. The nature of these proceedings is as follows:

	2012	2011
	Euro	
Legal proceedings		
Civil contingencies	74,163,129	67,154,450
Labor contingencies	478,806	457,197
Other contingencies	21,125,828	14,129,869
	95,767,763	81,741,516
Tax contingencies	2,562,502	6,351,520
	98,330,265	88,093,036

21.3. Description of the main claims with regulatory entities and other legal proceedings

The following litigation processes relate to the main claims and legal proceedings filed by regulatory entities against PT Comunicações, some of which the Company considers, based on the advice of its internal and external legal counsels that related losses are remote, in accordance with the definitions of NCRF 21.

a) Claims for municipal taxes and fees

Pursuant to a statute enacted on 1 August 1997, as an operator of a basic telecommunications network, Portugal Telecom was exempt from municipal taxes and rights-of-way and other fees with respect to its

PT Comunicações
Notes to Financial Statements (Continued)
As at 31 December 2012
(Amounts in Euro)

21. Provisions, contingent liabilities and contingent assets (Continued)

network in connection with its obligations under the Concession. The Portuguese Government has advised Portugal Telecom in the past that this statute confirmed the tax exemption under our Concession. The Portuguese Government has informed Portugal Telecom it will continue to take the necessary actions in order for PT Comunicações to maintain the economic benefits contemplated by the Concession.

Law 5/2004, dated 10 February 2004, established a new rights-of-way regime in Portugal whereby each municipality may establish a fee, up to a maximum of 0.25% of each wireline services bill, to be paid by the customers of those wireline operators whose network infrastructures are located in each such municipality. This regime was implemented in 2005 but does not affect the lawsuit described above based on the former statute. Meanwhile, Decree-Law 123/2009, dated 21 May 2009, clarified that no other tax should be levied by the municipalities in addition to the tax established by Law 5/2004. This interpretation was confirmed by the Supreme Administrative Court of Portugal in various legal actions.

Some municipalities however, continue to interpret that the Law 5/2004 does not expressly revoke other taxes that the municipalities wish to establish, because Law 5/2004 is not applicable to the public municipality domain. Currently, there are legal proceedings filed by some municipalities regarding this matter.

b) Regulatory proceedings

Portugal Telecom's operations are regularly subject to regulatory inquiries and investigations involving their operations. In addition, ANACOM (the telecommunications regulator), the European Commission, and the Autoridade da Concorrência (the competition authority) regularly make inquiries and conduct investigations concerning compliance with applicable laws and regulations. Current inquiries and investigations include several investigations by the (Autoridade da Concorrência) related to PT Comunicações for alleged anti-competitive practices in the public wireline telephone market. The Company believes that most of the complaints that have resulted in such investigations should be dismissed due to the nature of the alleged abuses and the novelty of the relevant antitrust laws. However, if PT Comunicações is found to be in violation of applicable laws and regulations in these or other regulatory inquiries and investigations, it could become subject to penalties, fines, damages or other sanctions. It is however permitted under Portuguese law to appeal any adverse decision to the Courts.

In April 2007, the Autoridade da Concorrência filed a complaint alleging that PT Comunicações abused its dominant market position by granting, in 2003, discriminatory discounts on lease lines. PT Comunicações challenged this claim with the authorities. However, on 1 September 2008, the Autoridade da Concorrência imposed a fine of Euro 2.1 million on PT Comunicações. PT Comunicações appealed to the Commerce Court of Lisbon, on 29 September 2008 and, on 29 February 2012, the Commerce Court of Lisbon cleared PT Comunicações of the fine. The Company, based on the opinion of its internal and external legal counsels, has not recorded any provision for this matter.

c) Other legal proceedings

In March 2004, TV TEL Grande Porto—Comunicações, SA. ("TVTEL"), a telecommunications company based in Oporto, filed a claim against PT Comunicações in the Lisbon Judicial Court. TV TEL alleged that, since 2001, PT Comunicações has unlawfully restricted access to its telecommunication ducts in Oporto, thereby undermining and delaying the installation and development of TV TEL's telecommunications network. TV TEL alleges that PT Comunicações intended to favor both itself and CATVP—TV Cabo Portugal, S.A, a PT Multimedia subsidiary and at the time a direct competitor of TV TEL. TV TEL is claiming an amount of approximately Euro 15 million from Portugal Telecom for damages and losses allegedly caused and yet to be sustained by that company as a result of the delay in the installation of its telecommunications network in Oporto. In addition, TV TEL has demanded that PT Comunicações be required to give full access to its ducts in Oporto. PT Comunicações submitted its

PT Comunicações
Notes to Financial Statements (Continued)
As at 31 December 2012
(Amounts in Euro)

21. Provisions, contingent liabilities and contingent assets (Continued)

defence to these claims, stating that: (1) TV TEL did not have a general right to install its network in PT Comunicações' ducts; (2) all of TV TEL's requests were lawfully and timely responded to by PT Comunicações according to its general infra-structure management policy; and (3) TV TEL's claims for damages and losses were not factually sustainable. The trial was concluded in 2011 and the parties wait for the judicial decision.

In March 2011, Optimus—Comunicações S.A. ("Optimus") filed a claim against PT Comunicações in the Judicial Court of Lisbon for the payment of approximately Euro 11 million and, in October 2011, Onitelecom—Infocomunicações, S.A ("Oni") filed a claim against PT Comunicações in the same court for the payment of approximately Euro 1.5 million, both related to the proceeding of the Autoridade da Concorrência that terminated in 2011 for prescription purposes, in relation to which Autoridade da Concorrência had imposed a fine to the Company of approximately Euro 45 million, as referred to above. Optimus and Oni sustained their position by arguing that they incurred losses and damages as a result of the Company's conduct. Regarding the Optimus legal action, the Company is waiting for the schedule of the trial, while In the Optimus action, the Company is waiting for the schedule of the trial, while regarding the Oni legal action, PT Comunicações was acquitted due to prescription reasons.

21.4. Other tax contingencies

In addition to the tax contingencies mentioned above, the risk of loss of which was deemed as either probable or possible (Note 21.2), there are other tax claims pending appeal or judicial decision, totalling Euro 23 million, which include primarily (1) tax assessments filed by the tax authorities with respect to the income tax from 1997 to 1998 of Portugal Telecom, SA and Marconi, and from 2002 to 2010 of PT Comunicações, and (2) additional payments of VAT from 2000 to 2004. The Company's opinion, based on the advice of its tax and legal counsel, is that the risk of loss associated with these claims is remote.

21.5. Provisions for losses on financial investments

Provisions for losses on financial investments are related to losses in subsidiaries and associated companies that have negative shareholders' equity (Note 12), and are computed based on the Company's share in the shareholders' equity of those entities. Movements in these provisions during the years ended 31 December 2012 and 2011 were as follows:

	<u>2012</u>	<u>2011</u>
	Euro	
Equity method		
Losses in subsidiaries and associated companies (Note 26)	5,110	19,974
Adjustments to financial assets (Note 20.5)	181	(463)
Liquidation of PT Ásia	—	(89)
	<u>5,291</u>	<u>19,422</u>

21.6. Contingent assets

As at 31 December 2012, the main contingent asset relates to a request for the transmission of tax losses from PT.Com, a company that was merged into PT Comunicações in 2004, amounting to Euro 56 million. The recovery of this amount depends on the appeal filed by the Company. The request filed by the Company was overruled by the tax authorities on 2 February 2007, and the Company challenged this decision on 15 May 2007 through a special administrative proceeding, which is pending a final decision.

PT Comunicações
Notes to Financial Statements (Continued)
As at 31 December 2012
(Amounts in Euro)

22. Loans obtained

Loans obtained as at 31 December 2012 and 2011 have the following composition:

	2012		2011	
	Non-current	Current	Non-current	Current
		Euro		
Intragroup loans (Note 12.3)	3,527,000,000	—	3,527,000,000	—
Centralized cash management (Note 12.3)	—	117,962,274	—	590,123,358
Commercial programme	2,631,600,000	1,047,150,000	1,667,250,000	919,500,000
Other financings	—	—	—	454,316,000
Leases	20,261,415	19,142,242	29,587,526	21,523,352
	6,178,861,415	1,184,254,516	5,223,837,526	1,985,462,710

22.1. Loans to Group companies

In February 2011, the Company obtained a loan from PT Portugal, amounting to Euro 727,000,000 (Note 4), as a result of which the total amount due increased to Euro 3,527,000,000. These loans have no defined maturity, but shall be repaid, partially or entirely, in more than one year, subject to the cash needs of the Company. The interest on these loans is linked to market rates.

22.2. Centralized cash management

As from March 2006, Portugal Telecom centralized all cash receipts and payments from Group companies located in Portugal. The financings obtained by the Company under this system have short term maturities and bear interest at market rates.

22.3. Commercial paper

On 25 June 1999, Portugal Telecom established a commercial paper program up to the amount of Euro 1,000,000,000. Following subsequent amendments to this program, the maximum amount under this program as at 31 December 2012 is Euro 3,500,000,000. This program is in place until 7 July 2013, and is automatically renewable for two year periods, until 7 July 2025, unless one of the parties objects to it. As at 31 December 2012 and 2011, the Company had issued an amount of Euro 1,440,400,000 and Euro 698,400,000, respectively, under this program, which was fully subscribed by PT Finance.

On 1 June 1999, Portugal Telecom had issued another commercial paper program up to the amount of Euro 1,350,000,000. Following subsequent amendments to this program, the maximum amount under this program as at 31 December 2012 is Euro 3,000,000,000. This program is in place until 1 June 2014, and is automatically renewable for two year periods, until 1 June 2020, unless one of the parties objects to it. As at 31 December 2012 and 2011, the Company had issued an amount of Euro 2,238,350,000 and Euro 1,888,350,000, respectively, under this program, which was fully subscribed by PT Finance.

22.4. Other loans

This caption relates to the amounts due to the Portuguese State in connection with the transfer of unfunded regulatory pension obligations concluded in 31 December 2010, which amounted to Euro 921.7 million as at 31 December 2010. The Company settled Euro 17.4 million and Euro 450.0 million in January and December 2011 (Note 4), respectively, having paid the remaining amount of Euro 454.3 million in December 2012 (Note 4).

The amounts reimbursed in 2012 and 2011 earned interest at an annual interest rate of 3.25% and 2.74%, respectively.

PT Comunicações
Notes to Financial Statements (Continued)
As at 31 December 2012
(Amounts in Euro)

22. Loans obtained (Continued)

22.5. Finance leases

Financial leasing obligations are essentially the result of: (i) lease contracts with respect to vehicles, under which there are generally purchase options at the end of their term, and (ii) contracts for the acquisition of satellite capacity, under which the Company has the right to use this capacity in the normal course of telecommunications operations, a right that is recorded by the Company as an intangible asset. The contracts for the acquisition of satellite capacity do not include purchase options but, generally, the Company has a preference in the allocation of future transponders' capacity.

As at 31 December 2012 and 2011, the Company had recorded in the balance sheet the following assets under finance leases:

	2012			2011		
	Gross value	Accumulated depreciation	Carrying value	Gross value	Accumulated depreciation	Carrying value
Euro						
Tangible fixed assets						
Transport equipment . . .	25,029,846	11,068,954	13,960,892	23,255,040	11,411,423	11,843,617
Other tangible fixed assets	1,441,277	467,471	973,806	1,269,542	170,676	1,098,866
	<u>26,471,123</u>	<u>11,536,425</u>	<u>14,934,698</u>	<u>24,524,582</u>	<u>11,582,099</u>	<u>12,942,483</u>
Intangible assets						
Industrial property and other rights	51,562,961	35,076,858	16,486,103	52,491,450	27,394,237	25,097,213
	<u>78,034,084</u>	<u>46,613,283</u>	<u>31,420,801</u>	<u>77,016,032</u>	<u>38,976,336</u>	<u>38,039,696</u>

As at 31 December 2012 and 2011, the maturity of minimum lease payments of leasing contracts was as follows:

	2012			2011		
	Capital	Interest	Total	Capital	Interest	Total
Euro						
Up to 1 year	19,142,242	1,695,621	20,837,863	21,523,352	2,257,423	23,780,775
Between 1 and 2 years . . .	14,479,139	883,072	15,362,211	12,310,260	1,373,531	13,683,791
Between 2 and 3 years . . .	4,252,715	152,839	4,405,554	14,147,200	692,326	14,839,526
Between 3 and 4 years . . .	835,871	63,208	899,079	3,079,467	41,974	3,121,441
Between 4 and 5 years . . .	693,690	22,604	716,294	50,599	1,545	52,144
	<u>39,403,657</u>	<u>2,817,344</u>	<u>42,221,001</u>	<u>51,110,878</u>	<u>4,366,799</u>	<u>55,477,677</u>

22.6. Other information

As at 31 December 2012, the Company was party, along with PT SGPS and PT Finance, to three Credit Facilities, with the following amounts and maturities:

- Euro 800 million, with maturity in June 2016;
- Euro 100 million, with maturity in January 2015;
- Euro 50 million, with maturity in January 2013.

As at 31 December 2012, the amount used by the PT Group within these three Facilities was Euro 750 million.

PT Comunicações
Notes to Financial Statements (Continued)
As at 31 December 2012
(Amounts in Euro)

22. Loans obtained (Continued)

As at 31 December 2012, the Company was also part, along with PT SGPS and PT Finance, in an Export Credit Facility, amounting to Euro 180 million, with a maturity in 2023. As at 31 December 2012, the amount used under this contract by PT Group was Euro 61 million.

As at 31 December 2012, the main covenants included in financing contracts, in relation to which the Company is collectively responsible along with PT SGPS and PT Finance, are as follows and refer to the consolidated accounts:

- **Change in control:** The exchangeable bonds, the credit facilities amounting to Euro 1,180 million and the loans obtained from the European Investment Bank (“EIB”) totalling Euro 602 million as at 31 December 2012 establish penalties in the case of a change in control of PT SGPS. According to the terms and conditions of these debt instruments, a change of control would occur if any person or group of persons acting in concert acquires or controls more than 50 per cent of voting rights, whether obtained by ownership of share capital, the holding of voting rights or pursuant to the terms of a shareholders’ agreement. In certain cases, gaining the power to appoint or remove all, or the majority, of the directors or other equivalent officers of PT SGPS or to give directions with respect to the operating and financial policies of PT SGPS with which the directors or equivalent officers of the company are obliged to comply are also considered a change of control.

The Euro 750 million Eurobond issued in 2012, the Euro 600 million Eurobond issued in 2011 and the Euro 1,000 million and Euro 750 million Eurobonds issued in 2009, establish penalties in the case of any change of control of Portugal Telecom, as described above, only if simultaneously a rating downgrade to sub-investment grade occurs (in case the securities are investment grade securities) or a rating downgrade occurs (in case the securities are sub-investment grade securities) during the Change of Control Period, as defined under the terms and conditions of these notes.

- **Control/disposal of subsidiaries:** Certain revolving credit facilities amounting to Euro 980 million require PT SGPS to, directly or indirectly, maintain majority ownership and control of each material subsidiary. Material subsidiaries are those companies whose total assets are equal or exceed 10% of total consolidated assets or whose total revenues are also equal or exceed 10% of total consolidated revenues.
- **Disposal of assets:** Revolving credit facilities totalling Euro 150 million and loans obtained from the EIB totalling Euro 602 million as at 31 December 2012 include certain restrictions regarding the disposal of assets by PT SGPS.
- **Financial ratios:** Certain revolving credit facilities totalling Euro 1,180 million require that Consolidated Net Debt/EBITDA PT SGPS’s ratio does not exceed certain values, which vary depending on each financing. As at 31 December 2012 and 2011, the ratio of Consolidated Net Debt / EBITDA consolidated was 3.3 and 2.6, respectively.
- **Negative Pledge:** The Euro Medium Term Notes, the exchangeable bonds, the credit facilities, the loans obtained from the EIB and the commercial paper programmes are subject to negative pledge clauses, which restrict the pledge of security interests in the assets of companies included in the consolidation.

The penalties applicable in the event of default in any of these covenants are generally the early payment of the loans obtained or the termination of available credit facilities. As at 31 December 2012, Portugal Telecom and PT Comunicações had fully complied with the covenants mentioned above.

Although current liabilities exceed current assets, the Company is not subject to liquidity risk, because of its ability to obtain needed capital from within the Portugal Telecom Group.

PT Comunicações
Notes to Financial Statements (Continued)
As at 31 December 2012
(Amounts in Euro)

23. Suppliers

The captions “Suppliers” and “Investment suppliers” as at 31 December 2012 and 2011 consist of the following:

	<u>2012</u>	<u>2011</u>
	Euro	
Trade suppliers		
Current	259,336,226	300,013,459
Invoices to be issued	28,605,385	40,319,127
	<u>287,941,611</u>	<u>340,332,586</u>
Investment suppliers		
Current	78,225,664	137,317,132
Invoices to be issued	29,906,857	39,626,895
	<u>108,132,521</u>	<u>176,944,027</u>

24. Accrued expenses

As at 31 December 2012 and 2011, this caption consisted of the following:

	<u>2012</u>	<u>2011</u>
	Euro	
Interest and other financial expenses payable(a)	67,038,381	163,750,159
Direct costs of services rendered	64,347,556	93,701,308
Charges for vacations, vacation subsidies and other payroll costs . . .	43,592,100	47,496,496
Support services	38,711,199	32,933,161
Other supplies and external services	17,628,505	19,488,011
Commissions	13,643,220	19,180,337
Credits related to invoices issued	8,427,354	7,109,590
Rentals	5,693,006	5,107,684
Maintenance and repairs	2,840,937	4,205,083
Marketing and publicity	2,560,743	4,125,302
Other	3,535,928	4,453,299
	<u>268,018,929</u>	<u>401,550,430</u>

(a) The reduction in this caption reflects primarily (i) the loans obtained from PT Portugal, the accrued interest of which decreased from Euro 122.7 million as at 31 December 2011 to Euro 62.1 million as at 31 December 2012, (ii) a reduction of Euro 17.8 million in the accrued interest under the loans obtained from Portugal Telecom under the centralized cash management system, and (iii) a decrease of Euro 14.8 million related to the amount of accrued interest as at 31 December 2011 in connection with the debt relating to the transfer to the Portuguese State of unfunded pension obligations, which had been fully repaid by the end of 2012.

PT Comunicações
Notes to Financial Statements (Continued)
As at 31 December 2012
(Amounts in Euro)

25. Services rendered and sales

As at 31 December 2012 and 2011, these captions consisted of the following:

	2012	2011
	Euro	
Services rendered		
Fixed telephone services	560,932,329	641,767,805
Television services	504,959,708	410,708,946
Leased lines and capacity	205,970,299	211,126,286
Internet	131,382,406	150,163,097
Data communications (services)	88,946,049	91,745,568
Publicity	47,073,327	59,181,550
Other	209,906,970	200,381,229
Sales	25,146,653	31,683,399
	1,774,317,741	1,796,757,880

26. Equity in earnings of affiliated companies

As at 31 December 2012 and 2011, this caption consists of the following:

	2012	2011
	Euro	
Gains and losses in affiliated companies		
Gains	120,780,232	153,609,414
Losses	(249,749)	(342,621)
	120,530,483	153,266,793

In 2012 and 2011, gains and losses in affiliated companies, resulting from the application of the equity method of accounting (Note 12), were recognized in the following captions:

	2012	2011
	Euro	
Financial investments (Note 10)		
TMN	117,781,679	150,356,837
CTM	2,833,845	2,507,757
Multicert	161,282	101,609
Capital Criativo	3,320	(59,615)
PT Brasil	106	1,288
Tele Larm	—	(263,032)
PT Sistemas de Informação	(2,191)	2,434
PT Blue Clip	(2,198)	—
Infonet	(111,957)	51,328
Janela Digital	(128,293)	588,161
	120,535,593	153,286,767
Provision for negative financial investments (Note 21)		
PT Sistemas de Informação	(824)	—
PT Prestações	(4,286)	(19,974)
	(5,110)	(19,974)
	120,530,483	153,266,793

PT Comunicações
Notes to Financial Statements (Continued)
As at 31 December 2012
(Amounts in Euro)

27. Direct costs

For the year ended 31 December 2012 and 2011, this caption consisted of the following:

	<u>2012</u>	<u>2011</u>
	Euro	
Telecommunications costs	313,292,455	234,860,603
Programming costs	122,587,397	120,025,755
Directories	26,422,716	35,565,918
Contents of internet and mobile service	8,892,759	7,910,408
Other	12,849,356	15,066,687
	<u>484,044,683</u>	<u>413,429,371</u>

28. Supplies and external services

For the year ended 31 December 2012 and 2011, this caption consisted of the following:

	<u>2012</u>	<u>2011</u>
	Euro	
Support services	179,003,249	190,826,237
Maintenance and repairs	74,820,724	95,426,317
Commissions	65,991,475	63,959,266
Electricity	33,370,729	30,358,332
Rentals	21,467,867	24,876,953
Specialized work	19,385,996	20,053,533
Communications	14,200,652	14,756,311
Fuel, water and other fluids	7,276,597	7,224,101
Other	29,887,307	26,500,418
	<u>445,404,596</u>	<u>473,981,468</u>

As at 31 December 2012 and 2011, the Company's obligations under operating lease contracts mature as follows:

	<u>2012</u>	<u>2011</u>
	Euro	
Up to 1 year	12,644,928	16,727,316
Between 1 and 2 years	3,172,757	5,154,812
Between 2 and 3 years	1,826,511	2,354,544
Between 3 and 4 years	1,120,629	1,113,356
Between 4 and 5 years	984,529	927,520
More than 5 years	2,314,921	2,504,675
	<u>22,064,275</u>	<u>28,782,223</u>

PT Comunicações
Notes to Financial Statements (Continued)
As at 31 December 2012
(Amounts in Euro)

29. Wages and salaries

For the year ended 31 December 2012 and 2011, this caption consisted of the following:

	<u>2012</u>	<u>2011</u>
	Euro	
Salaries	206,325,671	209,937,268
Social Security charges	21,517,595	21,759,053
Social events	3,481,623	3,365,744
Healthcare	1,788,231	2,112,494
Training	1,129,498	1,791,377
Other	1,247,970	1,089,703
	<u>235,490,588</u>	<u>240,055,639</u>

30. Indirect taxes

As at 31 December 2012 and 2011, this caption consists of the following:

	<u>2012</u>	<u>2011</u>
	Euro	
Anacom taxes	11,390,709	9,620,836
Direct taxes	1,411,517	1,637,930
Value Added Tax	1,036,709	1,157,838
Other	1,559,638	1,363,194
	<u>15,398,573</u>	<u>13,779,798</u>

31. Other income and gains

As at 31 December 2012 and 2011, this caption consists of the following:

	<u>2012</u>	<u>2011</u>
	Euro	
Supplemental income		
Studies, projects and technical assistance	3,755,443	4,082,629
Lease	14,174,671	13,168,135
Other supplemental income ^(a)	94,520,141	21,162,744
Investment subsidies (Note 20.7)	2,997,997	3,008,528
Interest due	2,457,716	3,190,132
Gains on exchange rate differences	1,293,338	3,041,125
Recovery of accounts receivable	837,609	1,031,875
Income from investment properties (Note 7)	638,953	640,122
Other	3,161,986	1,815,227
	<u>123,837,854</u>	<u>51,140,517</u>

(a) The increase in this caption reflects a gain of approximately Euro 60 million (Note 19) recorded in 2012 related to a net compensation receivable from the Portuguese State for prior years costs supported by PT Comunicações with the universal service obligation under the Concession Agreement, in accordance with Law 66/XII.

PT Comunicações
Notes to Financial Statements (Continued)
As at 31 December 2012
(Amounts in Euro)

32. Other expenses and losses

For the year ended 31 December 2012 and 2011, this caption consisted of the following:

	2012	2011
	Euro	
Write-off of tangible fixed assets	11,830,758	4,240,926
Losses in inventories	2,526,114	1,321,033
Losses on exchange rate differences	1,687,604	2,746,908
Contractual penalties incurred	1,463,704	556,791
Direct write-off of accounts receivable	868,315	3,603,447
Donations	693,260	1,329,381
Other	9,446,749	8,960,363
	<u>28,516,504</u>	<u>22,758,849</u>

33. Depreciation and amortisation ((losses)/reversals)

For the year ended 31 December 2012 and 2011, this caption consisted of the following:

	2012	2011
	Euro	
Tangible fixed assets (Note 6)	466,841,602	487,364,880
Intangible assets (Note 9)	30,330,408	30,165,225
Investment properties (Note 7)	482,639	450,348
	<u>497,654,649</u>	<u>517,980,453</u>

34. Interest and related income/expenses

The detail of these captions in the year ended 31 December 2012 and 2011 were as follows:

	2012	2011
	Euro	
Interest and related income		
Interest income	14,190,982	21,884,583
Gains on exchange rate differences	262,517	2,095,524
Other	814,413	506,858
	<u>15,267,912</u>	<u>24,486,965</u>
Interest and related expenses		
Interest expense	311,664,796	315,284,596
Bank commissions and expenses	3,954,254	2,913,514
Finance leases	2,730,486	2,723,547
Losses on exchange rate differences	288,259	1,610,548
Other	2,369,712	960,515
	<u>321,007,507</u>	<u>323,492,720</u>

PT Comunicações
Notes to Financial Statements (Continued)
As at 31 December 2012
(Amounts in Euro)

34. Interest and related income/expenses (Continued)

The detail of interest income and interest expenses in 2012 and 2011 is as follows:

	2012	2011
	Euro	
Interest income		
Intragroup loans ^(a)	14,059,430	21,286,966
Other	131,552	597,617
	14,190,982	21,884,583
Interest expense		
Intragroup loans ^(b)	158,957,483	177,010,434
Other ^(c)	152,707,313	138,274,162
	311,664,796	315,284,596

- (a) The decrease in interest income under this caption results primarily from the reduction in the amount of loans granted to TMN, which were reduced from Euro 500,000,000 to Euro 340,000,000 as at 25 December 2011 (Note 12.3).
- (b) The reduction in this caption reflects mainly a decrease in financial charges associated with a lower level of loans obtained under the centralized cash management system (Note 22.2).
- (c) The increase in this caption reflects mainly two effects: (i) an increase of Euro 26,848,423 associated with the outstanding amounts due under Commercial Paper Programmes (Note 22.3); and (ii) a reduction of Euro 12,363,939 in financial charges associated with the outstanding debt regarding the transfer of unfunded pension obligations to the Portuguese State (Note 22.4).

35. Earnings per share

Earnings per share for the years 2012 and 2011 were computed as follows:

	2012	2011
Net income	(86,901,669)	(369,353,353)
Number of shares (Note 20)	1,150,000,000	1,150,000,000
Basic earnings per share	(0.08)	(0.32)

There are no situations that create a dilutive effect, so the diluted earnings per share are the same as basic earnings per share.

PT Comunicações
Notes to Financial Statements (Continued)
As at 31 December 2012
(Amounts in Euro)

36. Guarantees and other financial commitments

As at 31 December 2012 and 2011, the Company had presented guarantees and comfort letters to third parties, as follows:

	2012	2011
	Euro	
Guarantees in favour of courts	1,871,435	1,779,313
Bank guarantees in favor of other entities:		
Municipalities	5,501,487	7,164,057
Highway construction entities	4,325,822	3,379,785
Ministry of Education	3,041,118	2,927,315
Ministry of Justice	2,487,978	1,592,915
CTT	2,007,831	2,039,000
Ministry of Health	1,038,512	—
Anacom	—	750,000
Other	4,518,108	5,531,458
	22,920,856	23,384,530
Total guarantees	24,792,291	25,163,843
Commitments of purchase before:		
Fixed asset and content suppliers	34,242,977	31,007,157
Suppliers of inventories	27,768,745	65,614,774
Other services	58,700,454	37,281,981
	120,712,176	133,903,912
Other commitments:		
Aquisition of RETI	—	1,094,382
	—	1,094,382

Bank guarantees presented to the tax authorities relate primarily to additional income tax assessments for which the Company submitted a claim or an appeal.

Purchase commitments refer to orders placed and not rendered, essentially for the acquisition of materials of infrastructure and telecommunications equipment in the normal course of operations.

37. Events occurred after the balance sheet date

On 13 January 2013, as mentioned in Note 10, Portugal Telecom entered into a definitive agreement for the sale of the 28% stake held by the Group in the share capital of CTM, including the 25% and 3% interests held by PT Participações and PT Comunicações, respectively.

The financial statements for the year ended 31 December 2012 were approved by the Board of Directors and authorized for issuance on 20 February 2013, but are still subject to General Shareholders Meeting approval, under the terms of Portuguese law.

Except for the above mentioned, there were no significant events after 31 December 2012 that would require adjustment or disclosure in these financial statements.

38. Note added for translation

These financial statements are a translation of the financial statements originally issued in Portuguese, in accordance with generally accepted accounting principles in Portugal. In case of discrepancies, the original version, in Portuguese, prevails.

MEO, S.A.

Financial Statements

MEO—SERVIÇOS DE COMUNICAÇÕES E MULTIMÉDIA, S.A.

BALANCE SHEETS

30 SEPTEMBER 2014 AND 31 DECEMBER 2013

	Notes	30 Sep 2014	31 Dec 2013
EURO			
ASSETS			
Non-current assets			
Tangible fixed assets	4	424,645,317	489,308,105
Goodwill		10,169,655	10,169,655
Intangible assets	4	355,151,312	373,418,097
Financial investments—equity method of accounting	5	4,923,305,858	5,018,409,027
Other financial assets		59,307	132,018
Deferred tax assets		36,426,192	36,745,599
Total non-current assets		5,749,757,641	5,928,182,501
Current assets			
Inventories		19,367,163	25,145,510
Accounts receivable—trade	6	382,921,544	243,731,103
Unbilled revenues	6	98,922,540	90,207,873
Advances to suppliers		6,048,322	4,530,872
State and other public entities		7,781,147	991
Shareholders and group companies	7	723,239	26,807,572
Other accounts receivable		7,903,372	8,428,301
Deferrals		12,267,510	7,499,276
Cash and bank deposits	3	78,581,128	10,250,097
Total current assets		614,515,965	416,601,595
Total assets		6,364,273,606	6,344,784,096
SHAREHOLDERS' EQUITY			
Share capital		47,000,000	47,000,000
Legal reserve		9,400,000	9,400,000
Other reserves		(755,149)	(755,149)
Adjustments to financial assets		5,797,435,686	4,663,137,631
Retained earnings		877,403,227	541,994,055
Net (loss) / income		(921,313,771)	336,146,179
Total shareholders' equity		5,809,169,993	5,596,922,716
LIABILITIES			
Non-current liabilities			
Provisions	8	—	2,779
Loans obtained	9	1,634,962	231,429,085
Deferred tax liabilities		—	106,386
Other accounts payable		9,933,010	14,840,169
Other financial liabilities		24,188,842	24,170,305
Total non-current liabilities		35,756,814	270,548,724
Current liabilities			
Provisions	8	16,633,955	19,012,430
Loans obtained	9	1,427,291	23,260,651
Deferrals		38,283,527	41,462,295
Accounts payable to group companies	7	50,950,232	2,755,033
Suppliers	10	195,353,188	166,794,643
Investment suppliers	10	9,792,028	27,914,009
Accrued expenses	11	158,468,710	147,782,211
Advances from accounts receivable		5,660,175	3,527,750
State and other public entities		22,046,655	25,678,387
Other accounts payable		20,731,038	19,125,247
Total current liabilities		519,346,799	477,312,656
Total liabilities		555,103,613	747,861,380
Total liabilities and shareholders' equity		6,364,273,606	6,344,784,096

The accompanying notes form an integral part of these financial statements.

Accountant

The Board of Directors

MEO—SERVIÇOS DE COMUNICAÇÕES E MULTIMÉDIA, S.A.
INCOME STATEMENTS
FOR THE NINE-MONTH PERIODS ENDED 30 SEPTEMBER 2014 AND 2013

	Notes	9M14	9M13
		Euro	
Services rendered	12	678,565,224	727,046,847
Sales	12	60,258,874	71,783,209
Subsidies to operation		3,468	4,050
Equity in earnings of affiliated companies, net	13	(1,034,661,138)	123,113,496
Own work capitalized		3,533,209	3,299,403
Costs of products sold		(65,436,405)	(79,918,832)
Direct costs	14	(151,595,135)	(152,082,078)
Marketing and publicity		(10,228,102)	(13,578,508)
Supplies and external services	15	(184,327,744)	(197,494,660)
Wages and salaries		(35,059,904)	(35,509,856)
Indirect taxes		(13,485,055)	(12,036,641)
Impairment of inventories ((losses)/reversals)		3,739,506	(1,311,021)
Impairment of accounts receivable ((losses)/reversals)	6	(4,533,639)	(10,205,387)
Provisions ((increases)/reductions)	8	5,470,619	(1,854,970)
Other income and gains		16,078,346	10,318,311
Other expenses and losses		(8,251,319)	(16,871,715)
INCOME BEFORE DEPRECIATION AND AMORTISATION, FINANCING EXPENSES AND TAXES		(739,929,195)	414,701,648
Depreciation and amortisation ((losses)/reversals)	4	(122,839,414)	(125,206,407)
OPERATING INCOME (BEFORE FINANCING EXPENSES AND TAXES)		(862,768,609)	289,495,241
Interest and related income		22,523	326,257
Interest and related expenses		(7,207,760)	(14,302,575)
INCOME BEFORE TAXES		(869,953,846)	275,518,923
Income taxes	16	(51,359,925)	(46,472,528)
NET (LOSS) / INCOME		(921,313,771)	229,046,395
Basic earnings per share	17	(98.01)	24.37

The accompanying notes form an integral part of these financial statements.

Accountant

The Board of Directors

MEO—SERVIÇOS DE COMUNICAÇÕES E MULTIMÉDIA, S.A.
STATEMENTS OF CHANGES IN SHAREHOLDERS' EQUITY
FOR THE NINE-MONTH PERIODS ENDED 30 SEPTEMBER 2014 AND 2013

		Share capital	Legal reserve	Other reserves	Adjustments to financial assets	Retained earnings	Net (loss)/ income	Total shareholders' equity
Euro								
Balance as at 1 January								
2013	A	47,000,000	9,400,000	(246,879)	5,203,390,307	291,096,512	251,574,189	5,802,214,129
Changes								
Foreign currency translation adjustments		—	—	—	(344,280,835)	—	—	(344,280,835)
Unpaid dividends		—	—	—	676,646	(676,646)	—	—
Other changes in shareholders' equity		—	—	—	(7,090,038)	—	—	(7,090,038)
	B	—	—	—	(350,694,227)	(676,646)	—	(351,370,873)
Net income	C						229,046,395	229,046,395
Comprehensive income	B+C							(122,324,478)
Operations with shareholders:								
Application of earnings		—	—	—	—	251,574,189	(251,574,189)	—
	D	—	—	—	—	251,574,189	(251,574,189)	—
Balance as at 30 September 2013	E=A+B+C+D	47,000,000	9,400,000	(246,879)	4,852,696,080	541,994,055	229,046,395	5,679,889,651
		Share capital	Legal reserve	Other reserves	Adjustments to financial assets	Retained earnings	Net (loss)/ income	Total shareholders' equity
Euro								
Balance as at 1 January 2014	F	47,000,000	9,400,000	(755,149)	4,663,137,631	541,994,055	336,146,179	5,596,922,716
Changes:								
Foreign currency translation adjustments (Note 5)		—	—	—	1,139,562,897	—	—	1,139,562,897
Unpaid dividends		—	—	—	737,007	(737,007)	—	—
Other changes in shareholders' equity (Note 5)		—	—	—	(6,001,849)	—	—	(6,001,849)
	G	—	—	—	1,134,298,055	(737,007)	—	1,133,561,048
Net loss	H						(921,313,771)	(921,313,771)
Comprehensive income	G+H							212,247,277
Operations with shareholders:								
Application of earnings		—	—	—	—	336,146,179	(336,146,179)	—
	I	—	—	—	—	336,146,179	(336,146,179)	—
Balance as at 30 September 2014	F+G+H+I	47,000,000	9,400,000	(755,149)	5,797,435,686	877,403,227	(921,313,771)	5,809,169,993

The accompanying notes form an integral part of these financial statements.

Accountant

The Board of Directors

MEO—SERVIÇOS DE COMUNICAÇÕES E MULTIMÉDIA, S.A.
STATEMENTS OF CASH FLOWS
FOR THE NINE-MONTH PERIODS ENDED 30 SEPTEMBER 2014 AND 2013

	Notes	9M14	9M13
		Euro	
OPERATING ACTIVITIES			
Collections from clients		757,093,567	918,660,427
Payments to suppliers		(464,023,116)	(571,672,064)
Payments to employees		(34,653,876)	(33,892,130)
Cash flows from operations		258,416,575	313,096,233
Cash receipts (payments) relating to income taxes	3.(a)	9,182,500	(46,285,729)
Other cash payments, net	3.(b)	(78,436,265)	(72,768,411)
Cash flows from operating activities (1)		189,162,810	194,042,093
INVESTING ACTIVITIES			
Cash receipts resulting from:			
Tangible fixed assets		7,197,194	551,501
Intangible assets		433,934	239,821
Interest and related income		1,283,813	1,534,470
Financial investments		300	—
Dividends	3.(c)	194,000,000	67,900,000
		202,915,241	70,225,792
Payments resulting from:			
Tangible fixed assets		(54,829,766)	(90,003,143)
Intangible assets		(16,404,629)	(15,104,963)
		(71,234,395)	(105,108,106)
Cash flows from investing activities (2)		131,680,846	(34,882,314)
FINANCING ACTIVITIES			
Cash receipts resulting from:			
Loans obtained	3.(d)	8,395,347	260,000,917
Subsidies		3,468	4,050
		8,398,815	260,004,967
Payments resulting from:			
Loans repaid	3.(d)	(253,414,462)	(377,675,629)
Interest and related expenses		(7,496,978)	(9,611,693)
		(260,911,440)	(387,287,322)
Cash flows from financing activities (3)		(252,512,625)	(127,282,355)
Change in cash and cash equivalents (4)=(1)+(2)+(3) . .		68,331,031	31,877,424
Cash and cash equivalents at the beginning of the period . .		10,250,097	7,757,210
Cash and cash equivalents at the end of the period	3.(e)	78,581,128	39,634,634

The accompanying notes form an integral part of these financial statements.

Accountant

The Board of Directors

INDEX

1.	Introduction	F-473
2.	Basis of presentation	F-473
3.	Cash flows	F-474
4.	Tangible fixed assets and intangible assets	F-475
5.	Financial investments—equity method of accounting	F-476
6.	Accounts receivable and unbilled revenues	F-477
7.	Shareholders and Group Companies	F-478
8.	Provisions and contingent liabilities	F-478
9.	Loans obtained	F-480
10.	Suppliers	F-480
11.	Accrued expenses	F-480
12.	Services rendered and sales	F-481
13.	Equity in earnings (losses) of affiliated companies	F-481
14.	Direct costs	F-481
15.	Supplies and external services	F-482
16.	Income tax	F-482
17.	Earnings per share	F-483
18.	Guarantees	F-484
19.	Events occurred after the balance sheet date	F-484

MEO—Serviços de Comunicações e Multimédia, S.A.

Notes to the Financial Statements

As at 30 September 2014

(Amounts stated in Euros)

1. Introduction

MEO—Serviços de Comunicações e Multimédia, S.A. (the “Company” or “Meo, S.A.”), formerly named TMN—Telecomunicações Móveis Nacionais, S.A., was incorporated on 22 March 1991; its principal activity is to provide mobile telecommunications services, and it is licensed by the Instituto das Comunicações de Portugal (“ICP”), currently the ICP—Autoridade Nacional de Comunicações (“ANACOM”), to provide complementary (land-based) mobile telecommunications services in Portugal, under the terms of license ICP—011/TCM, dated 16 March 1992. By resolution of the ANACOM Board of Directors on 28 February 2007, the right to utilise these frequencies was renewed for an additional period of 15 years, i.e., until 16 March 2022. At the end of the year 2000, Meo, S.A. was licensed by ANACOM to do business in the international mobile telecommunications system, under the terms of license IMT 2000/UMTS, dated 19 December 2000, under ICP number 02 / UMTS, effective until 11 January 2016 with the possibility of subsequent renewal for an additional 15 years. In December 2011, ANACOM notified Meo, S.A., in the context of an auction of spectrum held on 28-30 November, that it had acquired spectrum in the frequency bands at 800 MHz, 1.8 GHz and 2.6 GHz, allowing Meo, S.A. to provide 4G mobile services through the Long Term Evolution (“LTE”) technology, which represents an evolution from GSM and UMTS technologies. Meo, S.A. was licensed to use these frequencies for an initial period of 15 years, renewable for an additional period of 15 years.

On 5 May 2014, Portugal Telecom SGPS, S.A. (“Portugal Telecom”) subscribed a share capital increase of Oi, S.A. (“Oi”) through the contribution in kind of its 100% interest in PT Portugal SGPS, S.A. (“PT Portugal”). Following this transaction, PT Portugal became a wholly-owned subsidiary of Oi and is now the parent company of the group in Portugal, while Portugal Telecom no longer controls PT Portugal and its subsidiaries. The Company’s only shareholder continues to be PT Comunicações which in turn also continues to be a wholly-owned subsidiary of PT Portugal. Consequently, as from 5 May 2014, the Company is indirectly a wholly-owned subsidiary of Oi.

During the nine months period ended 30 September 2014, in connection with an internal corporate restructuring of PT Group for purposes of the Oi share capital increase undertaken on 5 May 2014, the following transactions involving either the company or its subsidiaries were completed:

- On 30 April 2014, PT Móveis, SGPS, S.A. (“PT Móveis”), a wholly-owned subsidiary of Meo, S.A., subscribed a share capital increase of Bratel BV by an amount of Euro 1,303 million;
- On 2 May 2014, PT Móveis disposed to Portugal Telecom, for an amount of Euro 4,195 million its 100% interest in Bratel BV, the company that held the investment in Oi, indirectly through Bratel Brasil, S.A. (“Bratel Brasil”). This operation generate a net loss of Euro 950 million recorded by PT Móveis which includes, (1) a capital gain of Euro 50 million reflecting the difference between the selling price (Euro 4,195 million) and the carrying value of the investment in Bratel BV (Euro 4,145 million) and (2) the transfer to net income of the cumulative amount of negative foreign currency translation adjustments that were recorded directly in shareholders’ equity between March 2011 (Oi’s acquisition date) and 2 May 2014, in the amount of Euro 950 million;
- On 2 May 2014, Portugal Telecom disposed to PT Móveis, for a total amount of Euro 2.240 million, its 100% interest in PT Participações, SGPS, S.A., the company that held, indirectly, a 75% interest in Africatel Holdings BV.

2. Basis of Presentation

These financial statements were prepared in accordance with Portuguese legislation, based on Decree-law nº. 158/2009, which approved the new Portuguese accounting system, named Sistema de Normalização Contabilística (“SNC”), including the conceptual structure, Normas Contabilísticas e de Relato Financeiro (“NCRF”) and Interpretative Standards, as approved by Notices nº 15652/2009, 15655/2009 and 15653/2009, respectively. As permitted by Decree-Law nº. 158/2009, the Company also applies the International Financial Reporting Standards (“IAS/IFRS”) and related interpretations (“SIC/

MEO—Serviços de Comunicações e Multimédia, S.A.
Notes to the Financial Statements (Continued)
As at 30 September 2014
(Amounts stated in Euros)

2. Basis of Presentation (Continued)

IFRIC”) issued by International Accounting Standards Board (IASB), in order to fill in the gaps or omissions in SNC regarding specific situations of certain transactions.

As the Portuguese accounting system does not cover interim financial reporting, these interim financial statements have been presented in accordance with IAS 34 Interim Financial Reporting (“IAS 34”) and therefore do not include all the information required by above mentioned Portuguese accounting system. Accordingly, these interim financial statements should be read in conjunction with the financial statements for the year ended 31 December 2013.

3. Cash Flows

For the purposes of the cash flow statement, the caption “Cash and cash equivalents” includes cash, bank deposits immediately available, net of bank overdrafts.

The Company is exposed to a liquidity risk if its sources of funding, including cash balance, operating cash inflows, divestments and cash flows obtained from financing operations, do not match with our financing needs, such as operating and financing outflows, investments, shareholder remuneration and debt repayments. Based on the cash flows generated by its operations, on the available cash and in the possibility to obtain financing from PT Portugal under the centralized cash management system, the Company believes that it is able to meet its obligations.

The cash flow statement was prepared in accordance with “NCRF 2 Statement of Cash Flows”, which includes the following:

(a) Cash receipts (payments) relating to income taxes

Under the special taxation regime for Groups of companies, the Company received Euro 9,182,500 from PT Portugal in the nine months period ended 30 September 2014 and paid Euro 46,285,729 to Portugal Telecom in the nine months period ended 30 September 2013. The change between both periods reflects the payments on account made by Meo, S.A. in the nine months period ended 30 September 2013, which did not take place in the nine months period ended 30 September 2014.

(b) Other payments, net

This caption includes essentially Value Added Tax and spectrum fees paid to the regulator ICP -Anacom.

(c) Dividends received

In the nine-month periods ended 30 September 2014 and 2013, this caption corresponds to dividends received from PT Móveis, amounting to Euro 194,000,000 and Euro 67,900,000, respectively (Note 5).

(d) Cash receipts (payments) resulting from loans obtained

In the nine-month periods ended 30 September 2014 and 2013, payments resulting from loans obtained, net of cash receipts resulting from loans obtained, consisted of the following:

	9M14	9M13
	Euro	
Receipts (payments) obtained under commercial paper programmes	(250,000,000)	260,000,000
Leases and other loans obtained	(3,125,643)	(1,590,779)
Intercompany loans within centralized cash management	8,106,528	(36,083,933)
Repayments of loans granted by PT Comunicações	—	(340,000,000)
	(245,019,115)	(117,674,712)

MEO—Serviços de Comunicações e Multimédia, S.A.
Notes to the Financial Statements (Continued)
As at 30 September 2014
(Amounts stated in Euros)

3. Cash Flows (Continued)

(e) Cash and cash equivalents

As at 30 September 2014 and 2013, this caption had the following detail:

	9M14	9M13
	Euro	
Bank deposits immediately available	71,317,604	36,330,147
Cash	7,263,524	3,304,487
Cash and bank deposits	78,581,128	39,634,634

4. Tangible fixed assets and Intangible assets

During the nine months period ended 30 September 2014, movements in tangible fixed assets were as follows:

	Land and natural resources	Buildings and other constructions	Basic equipment	Transportation equipment	Administrative equipment	Other tangible fixed assets	Tangible fixed assets in progress	Total
	Euro							
Gross value								
Opening balance	1,022,830	367,493,915	1,141,896,132	9,300,438	340,444,915	5,959,911	51,244,492	1,917,362,633
Acquisitions	—	1,120,546	2,282,795	262,897	5,673,759	283,027	11,851,691	21,474,715
Disposals	—	(319,491)	(164,655)	(1,215,184)	(9,977,641)	—	—	(11,676,971)
Transfers and write-offs	—	1,383,197	(9,618,110)	(23,496)	7,716,454	(6,278)	(23,380,857)	(23,929,090)
Closing balance	1,022,830	369,678,167	1,134,396,162	8,324,655	343,857,487	6,236,660	39,715,326	1,903,231,287
Accumulated depreciation and impairment losses								
Opening balance	—	245,879,379	862,970,304	6,189,612	307,592,255	5,422,978	—	1,428,054,528
Depreciation of the period	—	9,704,210	56,686,460	696,822	16,270,191	200,710	—	83,558,393
Disposals	—	(57,031)	(76,788)	(1,183,235)	(8,135,736)	—	—	(9,452,790)
Transfers and write-offs	—	(32,456)	(18,266,467)	43,103	(5,312,064)	(6,278)	—	(23,574,161)
Closing balance	—	255,494,102	901,313,509	5,746,302	310,414,646	5,617,410	—	1,478,585,970
Tangible assets, net	1,022,830	114,184,065	233,082,653	2,578,353	33,442,841	619,250	39,715,326	424,645,317

MEO—Serviços de Comunicações e Multimédia, S.A.
Notes to the Financial Statements (Continued)
As at 30 September 2014
(Amounts stated in Euros)

4. Tangible fixed assets and Intangible assets (Continued)

During the nine months period ended 30 September 2014, movements in intangible assets were as follows:

	Industrial property and other rights	Other intangible assets	Intangible assets in progress	Total
	Euro			
Gross value				
Opening balance	860,661,648	2,993,745	185,534	863,840,927
Acquisitions	20,719,275	—	102,945	20,822,220
Disposals	(1,541,656)	—	—	(1,541,656)
Transfers and write-offs	1,355,396	—	(170,590)	1,184,806
Closing balance	881,194,663	2,993,745	117,889	884,306,297
Accumulated amortisation and impairment losses				
Opening balance	487,754,641	2,668,189	—	490,422,830
Amortisation	39,156,129	124,892	—	39,281,021
Disposals	(1,107,721)	—	—	(1,107,721)
Transfers and write-offs	558,855	—	—	558,855
Closing balance	526,361,904	2,793,081	—	529,154,985
Intangible assets, net	354,832,759	200,664	117,889	355,151,312

Total capital expenditures for tangible fixed assets and intangible assets amounted to Euro 42.3 million in the nine months period ended 30 September 2014, reflecting investments in tangible fixed assets allocated essentially toward reinforcing mobile data capacity and network quality and expanding the coverage of the 3G/3.5G and 4G networks, and investments in intangible assets related to loyalty programme contracts with customers, which are amortised over the contract period (2 years). In the nine months period ended 30 September 2013, total capital expenditures for tangible fixed assets and intangible assets amounted to Euro 70.2 million.

Total depreciation and amortization expenses amounted to Euro 122,839,414 in the nine months period ended 30 September 2014, reflecting depreciation of tangible fixed assets amounting to Euro 83,558,393 and amortization of intangible assets amounting to Euro 39,281,021. In the nine months period ended 30 September 2013, total depreciation and amortization expenses amounted to Euro 125,206,407.

During the nine months period ended 30 September 2014, the carrying amount of intangible assets included amounts in respect of personnel expenses of Euro 3,533,209, relating to own work capitalized (payroll cost and external supplies).

5. Financial investments—Equity method of accounting

During the nine months period ended 30 September 2014, the movements occurred under this caption were as follows:

	Euro
Opening balance	5,018,409,027
Dividends	(194,000,000)
Equity method	98,896,831
Closing balance	4,923,305,858

MEO—Serviços de Comunicações e Multimédia, S.A.
Notes to the Financial Statements (Continued)
As at 30 September 2014
(Amounts stated in Euros)

5. Financial investments—Equity method of accounting (Continued)

In the nine months period ended 30 September 2014, the movements occurred in investments in subsidiary resulting from the application of the equity method of accounting were recorded as follows:

	Euro
Gains in affiliated companies, net (Note 13)	(1,034,664,217)
Adjustments to financial assets	1,133,561,048
	98,896,831

6. Accounts receivable and unbilled revenues

As at 30 September 2014 and 31 December 2013, these captions consist of:

	30 Sep 2014			31 Dec 2013		
	Gross value	Impairment losses	Net value	Gross value	Impairment losses	Net value
	Euro					
Trade accounts receivable— current assets	462,246,233	(79,324,689)	382,921,544	329,562,219	(85,831,116)	243,731,103
Trade accounts receivable— non-current assets	55,361	—	55,361	128,127	—	128,127
Accounts receivable	462,301,594	(79,324,689)	382,976,905	329,690,346	(85,831,116)	243,859,230
Unbilled revenues	98,922,540	—	98,922,540	90,207,873	—	90,207,873
	561,224,134	(79,324,689)	481,899,445	419,898,219	(85,831,116)	334,067,103

The increase in accounts receivable reflects mainly receivables from group companies, especially from PT Comunicações. This increase, together with the lower services rendered, explains the reduction in collections from clients in the nine months period ended 30 September 2014, as compared to the same period of last year.

In the nine months period ended 30 September 2014, changes in accumulated impairment losses related to accounts receivable were as follows:

	Euro
Opening balance	85,831,116
Increases (reversals)	4,533,639
Utilizations ^(a)	(11,040,066)
Closing balance	79,324,689

(a) This line item refers to the use of accrued impairment losses to face of credits of doubtful collection that were deemed uncollectible and that were fully adjusted.

MEO—Serviços de Comunicações e Multimédia, S.A.
Notes to the Financial Statements (Continued)
As at 30 September 2014
(Amounts stated in Euros)

7. Shareholders and Group Companies

As at 30 September 2014 and 31 December 2013, these captions consist of:

	<u>30 Sep 2014</u>	<u>31 Dec 2013</u>
	Euro	
DEBIT BALANCES		
Current		
Intercompany loans granted within centralized cash management	277,772	8,384,405
Accounts receivable from PT SGPS within tax consolidation ^(a)	—	18,423,167
Other	445,467	—
Total debit balances with shareholders and group companies	<u>723,239</u>	<u>26,807,572</u>
CREDIT BALANCES		
Current		
Accounts payable to PT Portugal within tax consolidation ^(a)	46,824,345	—
Other	4,125,887	2,755,033
Total credit balances with shareholders and group companies	<u>50,950,232</u>	<u>2,755,033</u>

(a) The receivable as at 31 December 2013 corresponds to the difference between withholding income tax and payments on account made during the year 2013 and the estimated income tax for the year 2013. During the nine months period ended 30 September 2014, the Company have not yet made any payments on account to PT Portugal under the tax consolidation regime, and as a result the Company recorded a net payable as at 30 September 2014 corresponding basically to the estimated income tax for the nine months period ended 30 September 2014.

8. Provisions and contingent liabilities

8.1. Movements occurred in provisions

The movements in provisions during the nine months period ended 30 September 2014 were as follows:

	<u>Tax claims</u>	<u>Other litigation</u>	<u>Provision for negative financial investments (Note 13)</u>	<u>Other provisions</u>	<u>Total</u>
	Euro				
Opening balance	1,273,630	10,849,818	2,779	6,888,982	19,015,209
Increases	313,588	53,018	—	—	366,606
Reductions	(67,801)	(529,208)	(3,079)	(5,240,216)	(5,840,304)
Utilizations	(1,205,829)	—	—	—	(1,205,829)
Other movements	4,297,973	—	300	—	4,298,273
Closing balance	<u>4,611,561</u>	<u>10,373,628</u>	<u>—</u>	<u>1,648,766</u>	<u>16,633,955</u>

8.2. Proceedings with probable losses

The provision for taxes is to cover several Corporate Income Tax and Social Security contingencies, as well as other taxes and fees.

The provision for legal processes in progress is to cover liabilities resulting from processes brought against the Company, estimated based on information from its lawyers.

As at 30 September 2014, the Company, based on the opinion of its internal and external lawyers, classified several legal and arbitration processes in progress and tax contingencies as of probable loss and so it recorded provisions in accordance with NCRF 21—Provisions, Contingent Liabilities and

MEO—Serviços de Comunicações e Multimédia, S.A.
Notes to the Financial Statements (Continued)
As at 30 September 2014
(Amounts stated in Euros)

8. Provisions and contingent liabilities (Continued)

Contingent Assets to cover the probable outflow of resources. As at 30 September 2014 and 31 December 2013, the nature of these proceedings is as follows:

	<u>30 Sep 2014</u>	<u>31 Dec 2013</u>
	Euro	
Legal proceedings		
Civil contingencies	9,818,334	10,245,469
Labor contingencies	29,662	24,632
Other contingencies	<u>525,632</u>	<u>579,717</u>
	<u>10,373,628</u>	<u>10,849,818</u>
Tax contingencies	<u>4,611,561</u>	<u>1,273,630</u>
	<u>14,985,189</u>	<u>12,123,448</u>

8.3. Proceedings with possible losses

As at 30 September 2014, the Company, in accordance with NCRF 21 and based on the opinion of internal and external legal counsel, had classified a variety of ongoing judicial and arbitral actions and tax contingencies as proceedings with possible losses. The nature of these proceedings is as follows:

	<u>30 Sep 2014</u>	<u>31 Dec 2013</u>
	Euro	
Legal proceedings		
Civil contingencies	750,000	780,759
Labor contingencies	1,887	1,683
Other contingencies	<u>7,407,217</u>	<u>2,180,597</u>
	<u>8,159,104</u>	<u>2,963,039</u>

The Board of Directors believes that any corrections resulting from audits/inspections of tax returns by the tax authorities will not have a significant effect on the financial statements as of and for the nine months period ended 30 September 2014, considering the provisions constituted and the expectations at the date hereof with respect to the final resolution of the above-referenced matters.

8.4. Other proceedings

The Company received additional income tax assessments relating to the financial years from 2004 to 2010, which essentially question the deductibility of certain financial costs, in the total amount of Euro 204 million of taxes. The Company disagrees with these assessments and conclusions, and considers, based on the opinion of its tax counsel, that there are solid arguments to oppose the position of the tax authorities. As such, the company consider that this proceeding with possible loss.

MEO—Serviços de Comunicações e Multimédia, S.A.
Notes to the Financial Statements (Continued)
As at 30 September 2014
(Amounts stated in Euros)

9. Loans obtained

Loans obtained as of 30 September 2014 and 31 December 2013 consisted of the following:

	30 Sep 2014		31 Dec 2013	
	Non-current	Current	Non-current	Current
	Euro			
Commercial programme	—	—	230,000,000	20,000,000
Other financings	—	10,942	—	2,020,914
Leases	1,634,962	1,416,349	1,429,085	1,239,737
	1,634,962	1,427,291	231,429,085	23,260,651

During the nine months period ended 30 September 2014, the reduction in outstanding amounts due under loans obtained reflects primarily the repayment of the amounts due under commercial paper programmes, amounting to Euro 250,000,000.

10. Suppliers and Investment suppliers

The captions “Suppliers” and “Investment suppliers” as at 30 September 2014 and 31 December 2013 consist of the following:

	30 Sep 2014	31 Dec 2013
	Euro	
Trade suppliers		
Current	189,272,682	162,474,110
Invoices to be received	6,080,506	4,320,533
	195,353,188	166,794,643
Investment suppliers		
Current	4,519,121	24,020,629
Invoices to be received	5,272,907	3,893,380
	9,792,028	27,914,009

11. Accrued expenses

As at 30 September 2014 and 31 December 2013, this caption had the following detail:

	30 Sep 2014	31 Dec 2013
	Euro	
Support services	51,270,891	55,519,444
Commissions	42,614,061	32,235,530
Direct costs of services rendered	21,564,041	19,565,533
Other supplies and external services	13,044,383	11,333,716
Specialized work	7,851,355	6,338,406
Charges for vacations, vacation subsidies and other payroll costs	7,587,366	6,576,148
Litigation and legal actions	7,353,215	9,014,706
Interest and other financial expenses payable	222,560	1,836,321
Other	6,960,838	5,362,407
	158,468,710	147,782,211

MEO—Serviços de Comunicações e Multimédia, S.A.
Notes to the Financial Statements (Continued)
As at 30 September 2014
(Amounts stated in Euros)

12. Services rendered and sales

In the nine-month periods ended 30 September 2014 and 2013, these captions had the following detail:

	<u>9M14</u>	<u>9M13</u>
	Euro	
Services rendered		
Billing	622,669,523	678,736,662
Interconnection	49,450,250	39,573,940
Roaming operators	6,445,451	8,736,245
Sales	60,258,874	71,783,209
	<u>738,824,098</u>	<u>798,830,056</u>

13. Equity in earnings (losses) of affiliated companies

In the nine-month periods ended 30 September 2014 and 2013, this caption corresponds to the Company's share in the earnings and losses of the following affiliated companies:

	<u>9M14</u>	<u>9M13</u>
	Euro	
Gains and losses in affiliated companies		
PT Móveis	(1,034,664,295)	123,119,789
PT Cloud e Data Centers, S.A.	3,157	(6,293)
	<u>(1,034,661,138)</u>	<u>123,113,496</u>

The total net losses of Euro 1,034,661,138 recorded in the nine months period ended 30 September 2014 include a loss of Euro 1,034,664,217 recorded on financial investments (Note 5) and a gain of Euro 3,079 recorded on provisions for negative financial investments (Note 8).

The Company's share in net losses of PT Móveis, amounting to Euro 1,034,664,295, reflects primarily a net loss of Euro 950 million recorded by PT Móveis, in connection with the disposal of its 100% interest in Bratel BV to Portugal Telecom, which includes (1) a capital gain of Euro 50 million reflecting the difference between the sale price (Euro 4,195 million) and the carrying value of the total investment in Bratel BV (Euro 4,145 million, already reflecting the share capital increase realized by PT Móveis in Bratel BV prior to the sale, amounting to Euro 1,303 million), and (2) the cumulative amount of negative currency translation adjustments, amounting to Euro 1,000 million, which were generated since the acquisition of the investment in Oi in March 2011 and transferred to net income upon the sale of this investment through Bratel BV on 2 May 2014.

14. Direct costs

In the nine-month periods ended 30 September 2014 and 2013, this caption is made up as follows:

	<u>9M14</u>	<u>9M13</u>
	Euro	
Capacity to rental costs	80,248,186	85,040,347
Interconnection costs	47,895,157	43,987,556
Leases	16,154,276	15,840,391
Contents of internet	6,747,867	6,569,027
Other	549,649	644,757
	<u>151,595,135</u>	<u>152,082,078</u>

MEO—Serviços de Comunicações e Multimédia, S.A.
Notes to the Financial Statements (Continued)
As at 30 September 2014
(Amounts stated in Euros)

15. Supplies and external services

In the nine-month periods ended 30 September 2014 and 2013, this caption is made up as follows:

	9M14	9M13
	Euro	
Support services	67,329,889	70,088,008
Commissions	46,591,684	51,672,589
Maintenance and repairs	17,621,898	21,362,576
Specialized work	15,764,581	18,781,364
Electricity	10,648,875	11,135,506
Rentals	10,026,633	10,245,442
Provide access	6,158,950	6,201,547
Communications	3,354,241	3,956,948
Transportation	2,198,417	2,934,431
Other	4,632,576	1,116,249
	<u>184,327,744</u>	<u>197,494,660</u>

16. Income tax

In 2013, companies located in mainland Portugal are subject to Corporate Income Tax at a base rate of 25%, increased (1) up to a maximum of 1.5% of taxable income through a municipal tax, and (2) by a state surcharge levied at the rate of 3.0% on taxable income between Euro 1.5 million and Euro 7.5 million and at the rate of 5.0% on taxable income in excess of Euro 7.5 million.

As from 2014, companies located in mainland Portugal are subject to Corporate Income Tax at a base rate of 23%, increased (1) up to a maximum of 1.5% of taxable income through a municipal tax, and (2) by a state surcharge levied at the rates of 3.0% on taxable income between Euro 1.5 million and Euro 7.5 million, 5.0% on taxable income between Euro 7.5 million and Euro 35.0 million and 7.0% on taxable income in excess of Euro 35.0 million, resulting in a maximum aggregate tax rate of approximately 31.5% for taxable income higher than Euro 35.0 million.

Since the Company's tax profits in the nine-month periods ended 30 September 2014 and 2013 exceeded the Euro 35.0 million and Euro 7.5 million thresholds mentioned above, the Company applied the tax rate of 31.5% to compute its income tax estimate.

The Company's income taxes are computed based on the tax rate mentioned above and are determined on the basis of profit before-tax adjusted in accordance with tax legislation.

PT Portugal has adopted the tax consolidation regime in Portugal (currently known as the Special Regime for the Taxation of Groups of Companies), under which the provision for income taxes is determined on the basis of the estimated taxable income for all the companies in which PT Portugal holds at least 75% of the share capital and that are domiciled in Portugal and subject to Corporate Income Tax (IRC). PT Portugal is still waiting for the approval from the tax authorities in relation to the use of this tax consolidation regime in 2014, since PT Portugal only became the parent company of the group in Portugal as from 5 May 2014, following the contribution in kind made by Portugal Telecom to the Oi share capital increase consisting of its 100% interest in PT Portugal (Note 1). The Company is part of the Special Taxation Regime for Groups of Companies and, as a result, the income tax estimate and deductions made by third parties are recorded on the balance sheet as accounts payable and receivable of PT Portugal.

MEO—Serviços de Comunicações e Multimédia, S.A.
Notes to the Financial Statements (Continued)
As at 30 September 2014
(Amounts stated in Euros)

16. Income tax (Continued)

In the nine-month periods ended 30 September 2014 and 2013, the reconciliation between the expected tax by applying the nominal tax rate to income before taxes and the total income tax is as follows:

	9M14	9M13
	Euro	
Income before taxes	(869,953,846)	275,518,923
Nominal tax rate	31.5%	31.5%
Expected tax	(274,035,461)	86,788,461
Permanent differences ⁽ⁱ⁾	325,723,924	(38,871,277)
Adjustments to prior years' current income tax	4,306,443	(2,980,526)
Reversal of deferred taxes from previous years	(4,055,987)	1,495,180
Other	(578,994)	40,690
	51,359,925	46,472,528
Income tax		
Income tax-current	51,146,904	42,384,291
Deferred tax	213,021	4,088,237
	51,359,925	46,472,528

(i) Permanent differences are as follows:

	9M14	9M13
	Euro	
Equity method of accounting (Note 13)	1,034,661,138	(123,113,496)
Tax benefits	(560,038)	(545,332)
Other	(56,896)	257,950
	1,034,044,204	(123,400,878)
Nominal tax rate	31.5%	31.5%
	325,723,924	(38,871,277)

17. Earnings per share

Earnings per share for the nine-month periods ended 30 September 2014 and 2013 were computed as follows:

	9M14	9M13
	Euro	
Net income	(921,313,771)	229,046,395
Number of shares	9,400,000	9,400,000
Basic earnings per share	(98.01)	24.37

There are no situations that create a dilutive effect, so the diluted earnings per share are the same as basic earnings per share.

MEO—Serviços de Comunicações e Multimédia, S.A.
Notes to the Financial Statements (Continued)
As at 30 September 2014
(Amounts stated in Euros)

18. Guarantees

As at 30 September 2014 and 31 December 2013, the Company had presented the following guarantees in favour of third parties:

	<u>30 Sep 2014</u>	<u>31 Dec 2013</u>
	Euro	
Guarantees in favour of courts	180,543	105,370
Bank guarantees in favor of other entities:		
Anacom	18,000,000	24,000,000
Ministry of Justice	—	2,859,806
Outros	2,347,196	2,023,980
	<u>20,347,196</u>	<u>28,883,786</u>
Total guarantees	20,527,739	28,989,156
Commitments of purchase before:		
Fixed asset and content suppliers	3,083,611	8,981,302
Suppliers of inventories	17,233,504	8,264,400
Other services	10,168,742	12,387,759
	<u>30,485,857</u>	<u>29,633,461</u>

The bank guarantee provided in favour of Anacom as at 30 September 2014, in the amount of Euro 18 million, was requested by Anacom in the context of the auction of spectrum usage rights, and corresponds to the total amount of the three outstanding instalments.

As at 30 September 2014, the value for the bank guarantees provided in favour of other entities includes, essentially, the amount of Euro 1.5 million in respect of contracts to use stores.

As of 30 September 2014, Portugal Telecom had presented bank guarantees in favor of the tax authorities in relation to additional tax assessments received by Portugal Telecom regarding the tax consolidation of the years 2005 to 2010, thus including the tax contingencies of Meo, S.A. as well as tax contingencies of other entities included in the tax consolidation group, namely PT Comunicações, S.A. and Portugal Telecom. These bank guarantees totaled Euro 353 million as of 30 September 2014. In accordance with Portuguese tax legislation, Portugal Telecom has presented these guarantees and submitted a claim or an appeal to the tax authorities in order to be able to hold open discussions with the tax authorities and avoid the payment of a given tax assessment. In Portugal, these two conditions are required and must be complied with before the process can continue, regardless of the amount of the tax assessment or the likelihood of success of the appeal or the claim.

19. Events occurred after the balance sheet date

The financial statements as of and for the nine months period ended 30 September 2014 were approved by the Board of Directors and authorised for issuance on 13 January 2015.

On 1 December 2014, Oi entered into an exclusivity agreement with Altice, S.A. to allow both entities to negotiate and agree on the final terms of the sale of PT Portugal, excluding certain details. On 8 December 2014, the Board of Directors of Oi finalized the formalities to approve the general terms and conditions for the sale of all shares of PT Portugal to Altice Portugal, S.A., a wholly-owned subsidiary of Altice, S.A.. The sale substantially involves PT Portugal's operations in Portugal and Hungary. The effectiveness of the purchase and sale contract will depend on the approvals by the shareholders of Portugal Telecom SGPS, S.A., the meeting of which was initially scheduled for 12 January 2015 and then postponed to 22 January 2015, and by the proper regulatory entities. With this approval, Oi will transfer to Altice all of the shares issued by PT Portugal for an enterprise value of Euro 7.4 billion, adjusting for cash and debt and including an earn-out of Euro 500 million related to PT Portugal's generation of future

MEO—Serviços de Comunicações e Multimédia, S.A.
Notes to the Financial Statements (Continued)
As at 30 September 2014
(Amounts stated in Euros)

19. Events occurred after the balance sheet date (Continued)

revenue. The price to be paid by Altice will suffer adjustments usually adopted in similar transactions, in accordance with PT Portugal's cash holdings on the closing of this transaction.

On 29 December 2014, Meo, S.A. was merged into PT Comunicações and accordingly ceased to exist, but as its assets and liabilities were entirely transferred into PT Comunicações, the Company's activity will continue in the future. This merger produced effects as from 1 January 2014. Following this merger, PT Comunicações was renamed MEO—Serviços de Comunicações e Multimédia, S.A..

Financial Statements

AUDITORS' REPORT

Introduction

1. We have audited the accompanying financial statements of MEO—Serviços de Comunicações e Multimédia, S.A. ("the Company"), formerly named TMN—Telecomunicações Móveis Nacionais, S.A., which comprise the balance sheet as of 31 December 2013 that presents a total of 6,344,784,096 Euros and shareholders' equity of 5,596,922,716 Euros, including a net income of 336,146,179 Euros, the statements of income by nature, of changes in shareholders' equity and of cash flows for the year then ended and the corresponding notes.

Responsibilities

2. The preparation of financial statements that present a true and fair view of the financial position of the Company, the results of its operations, the changes in its shareholders' equity and its cash flows, as well as the adoption of adequate accounting principles and criteria and the maintenance of an appropriate system of internal control are the responsibility of the Company's Board of Directors. Our responsibility is to express a professional and independent opinion on these financial statements, based on our audit.

Scope

3. Our audit was performed in accordance with the auditing standards ("*Normas Técnicas e as Diretrizes de Revisão/Auditoria*") issued by the Portuguese Institute of Statutory Auditors ("*Ordem dos Revisores Oficiais de Contas*"), which require that the audit be planned and performed with the objective of obtaining reasonable assurance about whether the financial statements are free of material misstatement. An audit includes verifying, on a sample basis, evidence supporting the amounts and disclosures in the financial statements and assessing the significant estimates, based on judgements and criteria defined by the Board of Directors, used in their preparation. An audit also includes assessing the adequacy of the accounting principles used and their disclosure, taking into consideration the circumstances, verifying the applicability of the going concern concept and assessing the adequacy of the overall presentation of the financial statements. We believe that our audit provides a reasonable basis for expressing our opinion.

Opinion

4. In our opinion, the financial statements referred to in paragraph 1 above, present fairly, for the purpose explained in paragraph 5 below, in all material respects, the financial position of MEO—Serviços de Comunicações e Multimédia, S.A. as of 31 December 2013 and the results of its operations, the changes in its shareholders' equity and its cash flows for the year then ended, in conformity with generally accepted accounting principles in Portugal.

Emphases

5. The financial statements mentioned in paragraph 1 above refer to the Company on a standalone basis and were prepared in accordance with current legislation for approval and publication. The Company did not prepared consolidated financial statements as, in accordance with number 3 of article 7 of Decree-Law 158/2009, of 13 July 2009 was not required to do so, as its financial statements were included in the consolidated financial statements of Portugal Telecom, SGPS, S.A.. As described in Note 3.6, although the financial investments have been accounted for by the equity method, under which the Company's net profit for the year and shareholders' equity include the effect of consolidating the subsidiaries, the accompanying financial statements do not include the effects of a full consolidation of their assets, liabilities, revenues and costs.
6. As of 31 December 2013, the Company's financial investments included the wholly-owned subsidiary PT Móveis, S.A. ("PT Móveis"), which owned 100% interest in Bratel BV, a holding company that essentially owned the investment in Oi, S.A. and its controlling shareholders in the total amount of 2,589 million Euros. In connection with the business combination between Portugal Telecom, SGPS, S.A. ("PT SGPS") and Oi, as of 2 May 2014 this investment was sold to PT SGPS and PT Móveis incurred in a net loss of approximately 950 million Euros, of which 1,000 million Euros did not have an impact in the PT Móveis shareholders' equity as it corresponds to a transfer to net income of the cumulative amount of negative foreign currency translations adjustments that

were recorded directly in shareholders' equity between March 2011 (Oi's acquisition date) and 2 May 2014 (of which 885 million Euros recorded at 31 December 2013), while the remaining 50 million Euros corresponds to a capital gain reflecting the difference between the selling price and the carrying value of the investment in the books of PT Móveis.

Lisbon, 14 November 2014

Deloitte & Associados, SROC S.A.
Represented by João Luís Falua Costa da Silva

MEO—SERVIÇOS DE COMUNICAÇÕES E MULTIMÉDIA, S.A.
BALANCE SHEETS
31 DECEMBER 2013 AND 2012

	Notes	2013	2012
		Euro	
ASSETS			
Non-current assets			
Tangible fixed assets	6	489,308,105	530,538,646
Goodwill	7	10,169,655	10,169,655
Intangible assets	8	373,418,097	397,186,672
Financial investments—equity method of accounting	9,10	5,018,409,027	5,432,502,015
Other financial assets	12	132,018	17,802
Deferred tax assets	13	36,745,599	47,012,872
Total non-current assets		5,928,182,501	6,417,427,662
Current assets			
Inventories	14	25,145,510	21,346,581
Accounts receivable—trade	15	243,731,103	201,889,814
Unbilled revenues	15	90,207,873	104,201,086
Advances to suppliers		4,530,872	4,697,634
State and other public entities	16	991	275,246
Shareholders and group companies	10	26,807,572	—
Other accounts receivable	17	8,428,301	10,310,982
Deferrals	11	7,499,276	9,759,416
Cash and bank deposits	4	10,250,097	7,757,210
Total current assets		416,601,595	360,237,969
Total assets		6,344,784,096	6,777,665,631
SHAREHOLDERS' EQUITY			
Share capital	18	47,000,000	47,000,000
Legal reserve	18	9,400,000	9,400,000
Other reserves		(755,149)	(246,879)
Adjustments to financial assets	18	4,663,137,631	5,203,390,307
Retained earnings		541,994,055	291,096,512
Net (loss) / income	18	336,146,179	251,574,189
Total shareholders' equity		5,596,922,716	5,802,214,129
LIABILITIES			
Non-current liabilities			
Provisions	19	2,779	1,006
Loans obtained	20	231,429,085	341,311,519
Deferred tax liabilities	13	106,386	212,773
Other accounts payable	17	14,840,169	19,082,848
Other financial liabilities	12	24,170,305	34,932,378
Total non-current liabilities		270,548,724	395,540,524
Current liabilities			
Provisions	19	19,012,430	19,476,917
Loans obtained	20	23,260,651	40,402,346
Deferrals	11	41,462,295	52,281,265
Accounts payable to group companies	10	2,755,033	2,894,767
Suppliers	21	166,794,643	214,393,137
Investment suppliers	21	27,914,009	48,393,524
Accrued expenses	22	147,782,211	139,490,100
Advances from accounts receivable		3,527,750	3,883,876
State and other public entities	16	25,678,387	10,361,808
Other accounts payable	17	19,125,247	48,333,238
Total current liabilities		477,312,656	579,910,978
Total liabilities		747,861,380	975,451,502
Total liabilities and shareholders' equity		6,344,784,096	6,777,665,631

The accompanying notes form an integral part of these financial statements.

Accountant

The Board of Directors

MEO—SERVIÇOS DE COMUNICAÇÕES E MULTIMÉDIA, S.A.
INCOME STATEMENTS
FOR THE YEARS ENDED 31 DECEMBER 2013 AND 2012

	Notes	2013	2012
		Euro	
Services rendered	23	952,016,564	1,064,618,344
Sales	23	102,547,893	88,691,659
Subsidies to operation		10,402	31,191
Equity in earnings of affiliated companies, net	24	194,734,560	68,573,630
Own work capitalized	8	4,499,166	3,933,263
Costs of products sold	14	(113,023,015)	(107,376,947)
Direct costs	25	(198,571,074)	(225,254,423)
Marketing and publicity		(18,836,968)	(23,566,649)
Supplies and external services	26	(266,343,211)	(261,896,739)
Wages and salaries	27	(47,065,668)	(44,868,814)
Indirect taxes	28	(14,577,388)	(15,772,095)
Impairment of inventories ((losses)/reversals)	14	(1,592,073)	4,061,061
Impairment of accounts receivable ((losses)/reversals)	15	(9,832,211)	(11,166,860)
Provisions (increases/reductions)	19	(1,620,292)	(396,864)
Other income and gains	29	14,891,953	15,967,828
Other expenses and losses	30	(14,533,087)	(22,055,104)
INCOME BEFORE DEPRECIATION AND AMORTISATION, FINANCING EXPENSES AND TAXES .		582,705,551	533,522,481
Depreciation and amortisation ((losses)/reversals)	31	(168,231,485)	(180,786,175)
OPERATING INCOME (BEFORE FINANCING EXPENSES AND TAXES)		414,474,066	352,736,306
Interest and related income	32	438,187	1,382,653
Interest and related expenses	32	(18,819,781)	(22,464,897)
INCOME BEFORE TAXES		396,092,472	331,654,062
Income taxes	13	(59,946,293)	(80,079,873)
NET (LOSS) / INCOME		336,146,179	251,574,189
Basic earnings per share	33	35.76	26.76

The accompanying notes form an integral part of these financial statements.

Accountant

The Board of Directors

MEO—SERVIÇOS DE COMUNICAÇÕES E MULTIMÉDIA, S.A.
STATEMENTS OF CHANGES IN SHAREHOLDERS' EQUITY
FOR THE YEARS ENDED 31 DECEMBER 2012 AND 2013

		Share capital	Legal reserve	Other reserves	Adjustments to financial assets	Retained earnings	Net (loss)/ income	Total shareholders' equity
Euro								
Balance as at 1 January 2012	A	47,000,000	9,400,000	(189,875)	5,459,199,597	286,096,512	285,819,987	6,087,326,221
Changes:								
Foreign currency translation adjustments		—	—	—	(350,110,383)	—	—	(350,110,383)
Unpaid dividends		—	—	—	45,340,711	(45,340,711)	—	—
Other changes in shareholders' equity		—	—	(57,004)	48,960,382	—	—	48,903,378
	B	—	—	(57,004)	(255,809,290)	(45,340,711)	—	(301,207,005)
Net income	C						251,574,189	251,574,189
Comprehensive income	B+C							(49,632,816)
Operations with shareholders:								
Application of earnings		—	—	—	—	50,340,711	(285,819,987)	(235,479,276)
	D	—	—	—	—	50,340,711	(285,819,987)	(235,479,276)
Balance as at 31 December 2012	E=A+B+C+D	47,000,000	9,400,000	(246,879)	5,203,390,307	291,096,512	251,574,189	5,802,214,129
Changes:								
Foreign currency translation adjustments		—	—	—	(534,610,065)	—	—	(534,610,065)
Unpaid dividends		—	—	—	676,646	(676,646)	—	—
Other changes in shareholders' equity		—	—	(508,270)	(6,319,257)	—	—	(6,827,527)
	F	—	—	(508,270)	(540,252,676)	(676,646)	—	(541,437,592)
Net income	G						336,146,179	336,146,179
Comprehensive income	F+G							(205,291,413)
Operations with shareholders:								
Application of earnings		—	—	—	—	251,574,189	(251,574,189)	—
	H	—	—	—	—	251,574,189	(251,574,189)	—
Balance as at 31 December 2013	E+F+G+H	47,000,000	9,400,000	(755,149)	4,663,137,631	541,994,055	336,146,179	5,596,922,716

The accompanying notes form an integral part of these financial statements.

Accountant

The Board of Directors

MEO—SERVIÇOS DE COMUNICAÇÕES E MULTIMÉDIA, S.A.
STATEMENTS OF CASH FLOWS
FOR THE YEARS ENDED 31 DECEMBER 2013 AND 2012

	Notes	2013	2012
		Euro	
OPERATING ACTIVITIES			
Collections from clients		1,224,622,967	1,424,854,955
Payments to suppliers		(746,974,949)	(765,555,039)
Payments to employees		(46,321,075)	(48,749,295)
Cash flows from operations		431,326,943	610,550,621
Cash receipts (payments) relating to income taxes		(69,886,103)	(92,147,467)
Other cash payments, net	4.(a)	(101,668,460)	(85,798,643)
Cash flows from operating activities (1)		259,772,380	432,604,511
INVESTING ACTIVITIES			
Cash receipts resulting from:			
Tangible fixed assets		767,569	2,319,819
Intangible assets		282,836	336,507
Interest and related income		2,158,556	3,398,579
Dividends	4.(b)	67,900,000	5,000,000
		71,108,961	11,054,905
Payments resulting from:			
Tangible fixed assets		(126,374,727)	(163,204,445)
Intangible assets		(22,825,264)	(129,389,314)
		(149,199,991)	(292,593,759)
Cash flows from investing activities (2)		(78,091,030)	(281,538,854)
FINANCING ACTIVITIES			
Cash receipts resulting from:			
Loans obtained	4.(c)	251,999,195	47,025,471
Subsidies		10,402	31,191
		252,009,597	47,056,662
Payments resulting from:			
Loans repaid	4.(c)	(388,323,585)	(2,446,589)
Interest and related expenses		(42,874,475)	(5,226,344)
Dividends	18.4	—	(235,479,275)
		(431,198,060)	(243,152,208)
Cash flows from financing activities (3)		(179,188,463)	(196,095,546)
Change in cash and cash equivalents (4)=(1)+(2)+(3)		2,492,887	(45,029,889)
Cash and cash equivalents at the beginning of the period		7,757,210	52,787,099
Cash and cash equivalents at the end of the period	4.(d)	10,250,097	7,757,210

The accompanying notes form an integral part of these financial statements.

Accountant

The Board of Directors

TABLE OF CONTENTS

1.	Introduction	F-494
2.	Basis of presentation	F-495
3.	Main accounting policies, judgments and estimates	F-495
4.	Cash flows	F-503
5.	Changes in accounting policies and estimates and errors	F-504
6.	Tangible fixed assets	F-504
7.	Goodwill	F-505
8.	Intangible assets	F-506
9.	Financial investments—equity method of accounting	F-507
10.	Related parties	F-508
11.	Deferrals	F-513
12.	Other financial assets and liabilities	F-513
13.	Income taxes	F-514
14.	Inventories	F-517
15.	Accounts receivable and unbilled revenues	F-517
16.	State and other public entities	F-518
17.	Other accounts receivable and payable	F-519
18.	Shareholders' equity	F-519
19.	Provisions, contingent liabilities and contingent assets	F-521
20.	Loans obtained	F-523
21.	Suppliers	F-524
22.	Accrued expenses	F-525
23.	Services rendered and sales	F-525
24.	Equity in earnings of affiliated companies	F-525
25.	Direct costs	F-526
26.	Supplies and external services	F-526
27.	Wages and salaries	F-527
28.	Indirect taxes	F-527
29.	Other income and gains	F-527
30.	Other expenses and losses	F-528
31.	Depreciation and amortisation ((losses)/reversals)	F-528
32.	Interest and related income/expenses	F-528
33.	Earnings per share	F-529
34.	Guarantees and other financial commitments	F-529
35.	Events occurred after the balance sheet date	F-530
36.	Note added for translation	F-530

MEO—Serviços de Comunicações e Multimédia, S.A.
Annex to the Financial Statements
As of and for 31 December 2013
(Amounts expressed in Euros)

1. Introduction

MEO—Serviços de Comunicações e Multimédia, S.A. (the “Company” or “Meo, S.A.”), formerly named TMN—Telecomunicações Móveis Nacionais, S.A., was incorporated on 22 March 1991; its principal activity is to provide mobile telecommunications services, and it is licensed by the *Instituto das Comunicações de Portugal* (“ICP”), currently the ICP—*Autoridade Nacional de Comunicações* (“ANACOM”), to provide complementary (land-based) mobile telecommunications services in Portugal, under the terms of license ICP—011/TCM, dated 16 March 1992. By resolution of the ANACOM Board of Directors on 28 February 2007, the right to utilise these frequencies was renewed for an additional 15 years, i.e., until 16 March 2022. At the end of the year 2000, Meo, S.A. was licensed by ANACOM to do business in the international mobile telecommunications system, under the terms of license IMT 2000/UMTS, dated 19 December 2000, under ICP number 02 / UMTS, effective until 11 January 2016 with the possibility of subsequent renewal for an additional 15 years.

In December 2011, ANACOM notified Meo, S.A., in the context of an auction of spectrum held November 28-30, that it had acquired spectrum in the frequency bands at 800 MHz, 1.8 GHz and 2.6 GHz, for a total of 113 million Euros. This allows Meo, S.A. to provide 4G mobile services, through Long Term Evolution (“LTE”) technology, representing an evolution from GSM and UMTS technologies. Meo, S.A. was licensed to use these frequencies for an initial period of 15 years, renewable for an additional 15 years.

In addition, the Company may also provide other telecommunications services in Portugal, highlighted by the following:

- a) Meo, S.A. is registered to exercise the activity of telecommunications of public use;
- b) Meo, S.A. is licensed by ANACOM to provide land-line telephone service, under the terms of license ICP—010/99/99-SFT, and to establish and supply a public telecommunications network, under the terms of license ICP—017/99-RPT, both for the entirety of the Portuguese territory and dated 25 November 1999;
- c) Meo, S.A. is authorised to provide private virtual network services, having been assigned access code “70596.”

Among other regulations pursuant to Law 12/2008—Provision of Essential Public Services, as published in February 2008, the Company is afforded 6 months to bring suit against clients for non-payment, failing which, the debt lapses. In accordance with this Law, all electronic communications services (and not just landline telephone service) became subject to new regulations.

In 2008, in the context of the reorganisation process of the Portugal Telecom Group, Meo, S.A. acquired from Portugal Telecom, SGPS, S.A. (“PT SGPS” or “Portugal Telecom”) the stake it held in PT Acessos de Internet Wi-Fi, S.A. (“PT Wi-Fi”), which was merged into Meo, S.A., as of 1 January 2008.

Meo, S.A. holds one hundred percent of the share capital of PT Móveis—Serviços de Telecomunicações, SGPS, S.A. (“PT Móveis”). On 27 September 2010, PT Móveis sold to Telefónica Móviles, S.A. the 50% stake it held in the capital of Brasilcel N.V. (a joint venture controlling Vivo that was constituted at the end of 2002 between the Portugal Telecom Group—through PT Móveis—and the Telefónica Group—through Telefónica Móviles, S.A.). Subsequently, on 28 March 2011, Portugal Telecom completed the process of acquiring an effective stake of 25.3% in Telemar Norte Leste, S.A. (“Oi”) and 14.1% in Contax, S.A. and the agreements with the controlling shareholders of these companies, for a total of 8.437 billion Brazilian *Reais*. This investment was effected by the Portugal Telecom Group through Bratel Brasil, in which PT Móveis indirectly holds a 99% stake. The terms of these agreements allow Portugal Telecom to share decision-making power on the strategic financial and operating policies of the acquired companies, such that these are classified as jointly controlled entities, in accordance with the terms of IFRS 11—Joint Arrangements, and are recognised indirectly under the equity method. On 1 October 2013, Portugal Telecom, Oi and some of the principal shareholders of

MEO—Serviços de Comunicações e Multimédia, S.A.
Annex to the Financial Statements (Continued)
As of and for 31 December 2013
(Amounts expressed in Euros)

1. Introduction (Continued)

these entities signed a memorandum of understanding that establishes the essential principles for a merger proposal among PT, Oi and Oi's controlling shareholders with the objective of creating a single integrated company listed in Brazil. The Oi Group is a leading operator of telecommunications services in the Brazilian market and the largest operator of landline telecommunications in South America in terms of active clients, and Contax is one of the leading companies in corporate services and the leading company in contact centre services in Brazil.

On 30 November 2010, PT Portugal, SGPS, S.A. ("PT Portugal") sold to PT Comunicações, S.A. ("PT Comunicações") its entire stake in Meo, S.A., such that the Company came to be wholly owned by PT Comunicações.

Under the terms of article 7 of Decree-Law nº 158/2009, despite holding financial investments in group and associated companies, the Company is exempt from preparing consolidated financial statements since it is wholly owned, directly or indirectly, by Portugal Telecom, SGPS S.A. ("Portugal Telecom"), which in turn presents consolidated financial statements which include the financial statements of the Company and the entities in which it has a stake.

2. Basis of presentation

The financial statements annexed here were prepared in accordance with applicable provisions of Portuguese law, as set forth in Decree-Law nº 158/2009, which approved the *Sistema de Normalização Contabilística* ("SNC"), and in accordance with the conceptual framework, *Normas Contabilísticas e de Relato Financeiro* ("NCRF") and *Normas Interpretativas* issued, respectively, in notices 15652/2009, 15655/2009 and 15653/2009.

The Company first adopted the NCRF in 2010, applying NCRF 3 *Adoção Pela Primeira Vez Das NCRF* ("NCRF 3"), using 1 January 2009 as the transition date for the effects of presenting these financial statements. As provided in the Annex to Decree-Law nº 158/2009, the Company supplementarily applies the International Accounting Standards and International Financial Reporting Standards ("IAS/IFRS") and the respective interpretations ("SIC/IFRIC") of the IASB, to bridge gaps or omissions relating to specific aspects of some transactions or particular situations not provided for by the SNC.

3. Main accounting policies, judgments and estimates

The financial statements annexed here were prepared assuming ongoing operations. The main accounting policies adopted in preparing these financial statements are described below and were applied on a consistent basis, except as otherwise indicated.

3.1. Tangible fixed assets

Tangible fixed assets are recorded at the cost of acquisition or production, which includes the cost of purchase, any costs directly attributable to putting the assets in place in the conditions needed to operate as intended and, when applicable, the initial estimate of the costs that the company expects to incur in dismantling and removing the assets and restoring the respective premises where they were installed.

The subsequent expenses are included in the carrying amount for the asset only when it is probable that future economic benefits will flow to the Company and the cost can be reliably measured. Maintenance and repair costs not likely to generate future economic benefits are recognised as an expense in the period in which they are incurred.

MEO—Serviços de Comunicações e Multimédia, S.A.
Annex to the Financial Statements (Continued)
As of and for 31 December 2013
(Amounts expressed in Euros)

3. Main accounting policies, judgments and estimates (Continued)

Except for land that is not depreciated, depreciation of the other tangible fixed assets is recognised on a straight-line basis, as of such time as the asset is ready for use, with duodecimal imputation. The annual rates applied reflect the estimated useful life for each asset class, as follows:

<u>Asset class</u>	<u>Years of useful life</u>
Buildings and other constructions	3-50
Basic equipment	3-20
Transportation equipment	4-5
Administrative equipment	3-10
Other tangible fixed assets	4-8

The useful lives and the amortisation method are reviewed regularly, and the effect of any change in these estimates is recognised prospectively in the income statement.

Gains or losses stemming from a write-off or sale are determined as the difference between the amount received and the carrying amount for the asset, and are recognised in the income statement.

3.2. Leases

Leases are classified as financial leases if they transfer to the lessee substantially all the risks and rewards inherent to possessing the corresponding assets. All other leases are classified as operating leases. Leases are classified as a function of their substance and not their form.

Assets acquired by means of financial leases, as well as the corresponding liabilities, are recorded at the beginning of the lease at the lesser of the fair value of the assets and the present value of the minimum lease payments. The rents include financial expense and amortisation of the capital, wherein financial expenses are imputed in accordance with a constant periodic interest rate on the remaining balance of the liability.

In operating leases, rents owed are recognised as an expense on a linear basis during the lease period.

3.3. Concentrations of business activities and goodwill

Acquisitions of financial investments in subsidiary companies are recorded using the purchase method. The acquisition cost is determined by aggregating, at the acquisition date, the following components: (a) the fair value of the assets delivered or deliverable; (b) the fair value of the liabilities incurred or assumed; (c) the fair value of equity instruments issued by the Company in exchange for obtaining control over the subsidiary; and (d) the costs directly attributable to the acquisition. When applicable, the acquisition cost includes the effect of contingent payments agreed upon in the context of the transaction, and subsequent changes in such payments are recorded as a counter-entry to the corresponding goodwill.

Goodwill represents the excess of the acquisition cost over the fair value of the identifiable assets, liabilities and contingent liabilities of the acquired company, at the acquisition date, pursuant to NCRF 14 *Concentrações de Atividades Empresariais* ("NCRF 14"). If the difference between the acquisition cost and the fair value of the assets and liabilities acquired is negative, it is recognised as income for the year. Pursuant to the exception provided in NCRF 3, the Company applied the provisions of NCRF 14 only to acquisitions after 1 January 2009, such that the amounts of goodwill relating to acquisitions prior to such date were retained as initially calculated in accordance with the standard applicable at the time.

Goodwill arising from acquiring subsidiary companies is included on the balance sheet as "Goodwill."

Goodwill is not amortised, and is subject to tests for impairment on an annual basis or whenever there is indication of a loss of value. For purposes of impairment testing, goodwill is allocated to cash-generating

MEO—Serviços de Comunicações e Multimédia, S.A.
Annex to the Financial Statements (Continued)
As of and for 31 December 2013
(Amounts expressed in Euros)

3. Main accounting policies, judgments and estimates (Continued)

units. Any impairment loss is immediately recorded as an expense in the income statement for the period and cannot later be reversed.

3.4. Intangible assets

Intangible assets include, basically, (1) rights and licenses, (2) commercial goodwill, (3) terminal equipment assigned to clients pursuant to service contracts with them, and (4) development expenses. Intangible assets acquired separately are recorded at cost, less accrued amortisations and impairment losses.

Intangible assets are amortised on a straight-line basis in accordance with the following estimated useful lives:

<u>Asset class</u>	<u>Useful life</u>
License UMTS (3G)	Period of the license with a renewal period (until 2030)
License LTE (4G)	Period of the license with a renewal period (until 2042)
Rights over terminal equipment assigned to clients	Contractual terms (2 years)
Other intangible assets	3 years

The useful lives and method of amortising the various intangible assets are reviewed annually, and the effects of any changes in these estimates are recognised in the income statement prospectively.

Research expenses are recognised in the income statement when incurred. Development expenses are capitalized when the technical and economic feasibility of the product or process under development can be shown and the Company has the intention and capability to complete its development and begin marketing or using it, as provided in NCRF 6 *Activos Intangíveis*.

3.5. Impairments of tangible fixed assets and intangible assets

The Company tests for impairment its tangible and intangible assets whenever there is an event or change that indicates that the amount at which the asset is booked may not be recovered. Should there be such indication, the Company proceeds to determine the recoverable value of the asset, so as to determine the extent of the impairment loss. When it is not possible to determine the recoverable amount of an asset, the recoverable amount for the cash-generating unit to which such asset belongs is estimated.

In addition, in the specific case of terminal equipment assigned to clients pursuant to loyalty programme contracts, impairment is tested periodically, and the assets are fully written off in cases where the revenue associated with the client giving rise to the intangible asset is not assured.

The recoverable amount is determined as the higher of the sale price and the use value. The sale price is the amount that would be obtained by selling the asset in a transaction between knowledgeable independent entities, less the costs directly attributable to the sale. The use value derives from future cash flows as discounted to reflect the cost of capital and the specific risk of the asset.

Whenever the book value of the asset or of the cash-generating unit exceeds its recoverable amount, an impairment loss is recognised and recorded in the income statement.

MEO—Serviços de Comunicações e Multimédia, S.A.
Annex to the Financial Statements (Continued)
As of and for 31 December 2013
(Amounts expressed in Euros)

3. Main accounting policies, judgments and estimates (Continued)

3.6. Financial investments

Subsidiary companies are all the entities over which the Company has decision-making power over financial and operating policies, generally represented by more than half of the voting rights. Associated companies are entities over which the Company exercises significant influence, but does not have control, generally with stakes of between 20% and 50% of the voting rights.

Investments in the Company's subsidiaries are recorded using the equity method of accounting. In accordance with this method, financial investments are initially recorded at their acquisition cost and subsequently adjusted as a function of observed changes, after the acquisition, in the Company's interest in the net assets of the corresponding entities. The Company's results include its interest in the corresponding results of these entities.

Financial investments are tested whenever there is an indication that the asset may be impaired, and existing impairment losses are recorded as expenses in the income statement.

Unrealised gains in transactions with subsidiaries are eliminated in proportion to the Company's interest in them, with a counter-entry to the corresponding investment line item.

3.7. Accrual accounting

The Company records its revenue and expenses on an accrual basis, under which revenues and expenses are recognised to the extent they are generated or incurred, regardless of when they are received or paid, respectively.

3.8. Income taxes

Income taxes correspond to the sum of current and deferred taxes, which are recorded in the income statement except when they relate to items recorded directly in shareholders' equity, in which case they are likewise recorded in shareholders' equity.

Income taxes are estimated based on the estimate of the tax base under the *Imposto sobre o Rendimento das Pessoas Coletivas* ("IRC").

Portugal Telecom makes use of tax consolidation under the *Regime Especial de Tributação de Grupos de Sociedades* ("RETGS"), in which Meo, S.A. is included. Consequently, the estimated IRC amounts, less withholding effected by third parties and advance payments, are recorded on the balance sheet as accounts payable to Portugal Telecom.

The income taxes for the year recorded in the financial statements are calculated pursuant to NCRF 25 *Impostos Sobre o Rendimento*. In measuring income taxes for the year, in addition to the current tax determined based on pre-tax results as adjusted in accordance with tax law, the effects of temporary differences between the amounts of assets and liabilities for accounting purposes and the respective amounts for tax purposes are also taken into account. Deferred tax assets and liabilities are calculated and assessed annually, using the tax rates that are expected to be in effect at the date of the reversal of the temporary differences.

Deferred tax assets are recorded only when there is a reasonable expectation of sufficient future taxable profits to use them. At the balance sheet date, the temporary differences underlying the deferred tax assets are reappraised, for the purposes of recognising deferred tax assets that had gone unrecorded for not having fulfilled the conditions for recording, and/or reducing the amount of the deferred tax assets that are recognised as a function of current expectations of their future recovery.

MEO—Serviços de Comunicações e Multimédia, S.A.
Annex to the Financial Statements (Continued)
As of and for 31 December 2013
(Amounts expressed in Euros)

3. Main accounting policies, judgments and estimates (Continued)

3.9. Inventories

Inventories are recorded at the lesser of the acquisition cost and the net realisation value. The net realisation value represents the estimated sale price less all costs deemed necessary to complete the sale. The Company uses the average cost method.

Inventory impairment losses include the value of unutilised materials forecast by dint of technological obsolescence and/or turnover, as well as the difference of prices for materials whose realisation value is less than the average acquisition cost, to the extent that it exceeds the discount level considered normal in the business.

3.10. Accounts receivable from clients and other debtors

Accounts receivable from clients and other debtors are recognised initially at fair value, and are subsequently measured at cost or amortised cost, utilising the effective interest method, less impairment losses.

Impairments for debts of doubtful collection are calculated based on an evaluation of the estimated risks arising from non-collection of accounts receivable, and are recognised in the income statement in the period in which they arise.

3.11. Provisions, obligations and contingent liabilities

Provisions are recognised by the Company when there is a current obligation resulting from past events, provided it is probable that there will be an outlay of internal resources to settle such obligation and the amount of such outlay can be reasonably estimated. When any of these conditions is not fulfilled, the Company moves to disclose the events as contingent liabilities, unless the possibility of an outflow of funds is remote.

Provisions are recognised in an amount corresponding to the present value of the best estimate, at the reporting date, of the resources needed to settle the obligation. This estimate is determined considering the risks and uncertainties associated with the obligation. Provisions are reviewed at the end of each year and adjusted so as to reflect the best estimate at that date.

Obligations entailing the costs of dismantling and removing assets installed on others' property and restoring the respective premises are recognised when the assets start to be utilised and if it is possible to reliably estimate the respective obligation. The recognised amount of the obligation recognised corresponds to the present value of the obligation, and financial updating is recorded under "Other expenses and losses."

3.12. Loans obtained

Loans obtained are initially recognised at fair value, net of transaction costs incurred, and are subsequently presented at amortised cost, utilising the effective interest method.

3.13. Financial charges on loans obtained

The Company's policy is to capitalise the financial charges relating to loans obtained for the acquisition, construction or production of tangible assets. However, the Company has recognised financial charges as expenses when incurred, given that the construction period for the tangible and intangible assets has been relatively short.

MEO—Serviços de Comunicações e Multimédia, S.A.
Annex to the Financial Statements (Continued)
As of and for 31 December 2013
(Amounts expressed in Euros)

3. Main accounting policies, judgments and estimates (Continued)

3.14. Classification on the balance sheet

Assets realisable and liabilities due more than one year from the balance sheet date are classified, respectively, in non-current assets and liabilities, at their present value.

3.15. Transactions and balances in foreign currency

Transactions in foreign currency (i.e., not in the Company's functional currency) are recorded at the exchange rates at the dates of the transactions. Assets and liabilities expressed in foreign currency for which there is no agreement for setting the exchange rate are converted into Euros using the exchange rates in effect at the balance sheet date. Exchange rate differences, be they favourable or unfavourable, originating from differences between the exchange rates in effect at the date of the transactions and those in effect at the date of the collections or payments or at the balance sheet date, are recorded as revenue and expenses in the income statement.

At 31 December 2013 and 2012, assets and liabilities were converted to Euros based on the following exchange rates for the Euro, as published by Bank of Portugal (*Banco de Portugal*):

<u>Currency</u>	<u>2013</u>	<u>2012</u>
	Euro	
Swedish krona	8.8591	8.5820
Special Drawing Rights	1.1173	1.1658
American dollar	1.3791	1.3194
Swiss franc	1.2276	1.2072
Pound	0.8337	0.8161

3.16. Revenue

Revenue is measured at the fair value of the consideration received or receivable. Revenue to be recognised is netted of the estimated amount of refunds, discounts and other rebates, and does not include Value Added Tax ("VAT") and other taxes paid in connection with the sale.

Revenue from service provision is recognised with reference to the degree of completion of the transaction at the reporting date, provided all the following conditions are satisfied: (1) the amount of the revenue can be reliably measured; (2) it is probable that future economic benefits associated with the transaction will flow to the Company; (3) the expenses incurred or to be incurred in the transaction can be reliably measured; and (4) the degree of completion of the transaction at the reporting date can be reasonably estimated.

Revenues from telecommunications activities are recorded at their gross value, and unbilled amounts due or generated at the date of the financial statements, are recorded based on estimates and included under "Unbilled revenues." Differences between the estimated and actual amounts are recorded in the subsequent period.

Revenues relating to advances from clients are deferred, and are recognised only when the service is provided.

Revenues from international telecommunications services are calculated as a function of the termination rates established in bilateral agreements with the various telecommunications operators. These agreements also establish whether it is the operator of origin of the traffic that should present the credit to the operator of the destination country, or whether this latter must present the debit to the former.

The Company operates loyalty programmes for some of its customers, under which, as a function of consumption, clients have the right to loyalty points that can be exchanged for equipment, accessories and discounts on subsequent purchases of services. In the absence of specific SNC standards or

MEO—Serviços de Comunicações e Multimédia, S.A.
Annex to the Financial Statements (Continued)
As of and for 31 December 2013
(Amounts expressed in Euros)

3. Main accounting policies, judgments and estimates (Continued)

interpretations relating to this topic, the Company applies IFRIC 13 Customer Loyalty Programmes (“IFRIC 13”), in accordance with which it accounts for these operations as transactions containing multiple elements, such that the amount initially received is allocated between the revenue relating to the traffic consumed and the points that the customer obtains. Accordingly, the deferred revenue relating to the latter component is recognised when the points are used or expire.

Interest revenue is recognised based on the effective interest method.

3.17. Own work capitalized

Internal expenses incurred by the Company in forming fixed assets, essentially in respect of labour, are capitalized with a counter-entry to “Own work capitalized,” provided the following requirements are fulfilled: (a) the fixed assets that are developed are identifiable; (b) there is a strong probability that the fixed assets will generate future economic benefits; and (c) the development expenses are reliably measurable.

3.18. Financial assets and liabilities

Financial assets and liabilities are recognised on the balance sheet when the Company becomes party to the corresponding contractual provisions, and are classified at cost or amortised cost.

(a) Financial assets and liabilities at cost or amortised cost

Financial assets and liabilities are classified in the “at cost or amortised cost” category when they present the following characteristics: (a) they are on demand or have established maturities; (b) they have a fixed or determinable return associated with them; and (c) they neither are derivative financial instruments nor incorporate derivative financial instruments.

Financial assets and liabilities falling in this category are measured at cost or amortised cost, less accrued impairment losses (in the case of financial assets), and correspond essentially to the following line items of assets and liabilities included on the Company’s balance sheet:

- Loans obtained
- Shareholders and Group companies
- Accounts receivable—trade
- Suppliers and investment suppliers
- Unbilled revenues and accrued expenses
- Advances to suppliers and from clients
- State and other public entities
- Other accounts receivable and payable
- Other financial assets and liabilities
- Cash and bank deposits

The amortised cost is determined using the effective interest method. The effective interest rate is that which discounts exactly the estimated future payments or receipts during the expected life of the financial instrument in the net carrying amount of the financial asset or liability.

MEO—Serviços de Comunicações e Multimédia, S.A.
Annex to the Financial Statements (Continued)
As of and for 31 December 2013
(Amounts expressed in Euros)

3. Main accounting policies, judgments and estimates (Continued)

(b) Impairment of financial assets

Financial assets classified in the “at cost or amortised cost” category are tested for impairment at the end of each year. These financial assets are impaired when there is objective evidence that, as a result of one or more events occurring after initial recognition, their estimated future cash flows will be affected.

For financial assets measured at amortised cost, the impairment loss corresponds to the difference between the carrying amount of the asset and the present value of the new future estimated cash flows discounted at the respective original effective interest rate. For financial assets measured at cost, impairment loss corresponds to the difference between the carrying amount of the asset and the best estimate of the fair value of the asset.

Subsequently, if the impairment loss decreases as a result of an event occurring after the initial recognition of the loss, the impairment must be reversed per results. The reversal is effected only up to the limit of the amount that would be recognised (amortised cost) had the loss not been initially recorded.

Impairment losses and the respective reversals are recorded to the income statement essentially under “Impairment of accounts receivable ((losses)/reversals).”

(c) Derecognition of financial assets and liabilities

The Company derecognises financial assets only when its contractual rights to the cash flows from these assets expire, or when it transfers to another entity the financial assets and all the significant risks and benefits associated with their possession. Transferred financial assets in respect of which the Company has retained some significant risks and benefits are derecognised, provided control over them has been assigned.

The Company derecognises financial liabilities only when the corresponding obligation is settled, cancelled or expires.

3.19. Main accounting estimates and judgments

In preparing the financial statements in accordance with the NCRF, the Company’s Board of Directors uses estimates and assumptions that affect the application of policies and the amounts reported. The estimates and judgments are continuously evaluated and are based on the experience of past events and other factors, including expectations relating to future events deemed probable in light of the circumstances on which the estimates are based or as the result of information or experience. The most significant accounting estimates reflected in the financial statements are the following:

(a) Useful lives of tangible fixed assets and intangible assets

The Company utilised estimates to calculate the useful lives of tangible fixed assets and intangible assets.

(b) Recognition of provisions and impairments

The Company is party to a variety of ongoing judicial proceedings for which, based on the opinion of its lawyers, it used judgment to determine if it should recognise any provision in respect of these contingencies. Impairments for accounts receivable are calculated essentially based on the age of the accounts receivable, the risk profile of the clients and their financial situation.

The estimates were determined based on the best information available at the date the financial statements were prepared. As such, there may be events in subsequent periods that, not having been foreseeable at the time, were not considered in these estimates. In accordance with NCRF 4 *Políticas*

MEO—Serviços de Comunicações e Multimédia, S.A.
Annex to the Financial Statements (Continued)
As of and for 31 December 2013
(Amounts expressed in Euros)

3. Main accounting policies, judgments and estimates (Continued)

Contabilísticas, Alterações nas Estimativas Contabilísticas e Erros (“NCRF 4”), changes to these estimates that occur after the date of the financial statements are corrected in the income statement prospectively. For this reason and given the associated degree of uncertainty, actual results for the transactions in question may differ from the corresponding estimates.

3.20. Events occurred after the balance sheet date

Events occurred after the balance sheet date that provide additional information about conditions that existed at the balance sheet date are reflected in the financial statements. Events after the balance sheet date that provide information about conditions that arose after the balance sheet date are not reflected in the financial statements, and are only disclosed if deemed material.

4. Cash Flows

For the purposes of the statement of cash flows, “Cash and cash equivalents” includes cash, bank deposits immediately available and other short-term investments with elevated liquidity and initial maturities of up to three months, net of bank overdrafts, when applicable.

The Company is subject to liquidity risk if the sources of financing, such as available cash, operating cash flows and cash flows from disinvestment transactions and financing, do not meet existing needs, such as cash outflows relating to operations, investments, shareholder returns and the payment of principal and interest on debt. Based on the cash flows generated by its operations, available cash and the possibility of obtaining financing from Portugal Telecom in under the centralized cash management implemented in the Group, the Company believes it has the capacity to fulfil its obligations.

The statement of cash flows was prepared in accordance with NCRF 2 *Demonstração de Fluxos de Caixa*, with the following notable aspects:

(a) Other payments, net

This line item includes essentially Value Added Tax and spectrum fees paid to the regulator ICP—Anacom.

(b) Cash receipts resulting from dividends

In the years ended 31 December 2013 and 2012, this line item reflects dividends received from investee PT Móveis, in the amounts of 67,900,000 Euros and 5,000,000 Euros, respectively (Note 9).

(c) Receipts (payments) relating to loans obtained

In 2013 and 2012, payments resulting from loans obtained, net of cash receipts resulting from loans obtained, consisted of the following:

	2013	2012
	Euro	
Receipts obtained under commercial paper programmes (Note 20.3)	250,000,000	—
Leases and other loans obtained	(124,130)	(2,446,589)
Intercompany loans within centralized cash management	(46,200,260)	47,025,471
Reimbursement of the loans obtained to intercompany (Note 20.1)	(340,000,000)	—
	(136,324,390)	44,578,882

MEO—Serviços de Comunicações e Multimédia, S.A.
Annex to the Financial Statements (Continued)
As of and for 31 December 2013
(Amounts expressed in Euros)

4. Cash Flows (Continued)

(d) Cash and cash equivalents

At 31 December 2013 and 2012, this line item consisted of the following:

	2013	2012
	Euro	
Bank deposits immediately available	6,907,986	666,374
Cash	3,342,111	7,090,836
Cash and bank deposits	10,250,097	7,757,210

5. Changes in accounting policies and estimates and errors

No new or revised standards or interpretations were adopted in the year ended 31 December 2013, nor were there any voluntary changes in other accounting policies or changes in accounting estimates.

In the year ended 31 December 2013, no other new or revised standards or interpretations were issued that are not yet in force.

In the year ended 31 December 2013, there were no corrections of material errors from prior years.

6. Tangible fixed assets

6.1. Movement in tangible fixed assets

During the years ended 31 December 2013 and 2012, the movement in tangible fixed assets was as follows:

	2013							
	Land and natural resources	Buildings and other constructions	Basic equipment	Transportation equipment	Administrative equipment	Other tangible fixed assets	Tangible fixed assets in progress	Total
	Euro							
Gross value								
Opening balance . . .	1,022,830	361,009,230	1,177,171,210	8,939,324	338,724,314	5,937,300	68,998,892	1,961,803,100
Acquisitions	—	6,380,229	25,634,805	1,731,216	10,598,781	31,645	30,714,058	75,090,734
Disposals	—	(365,496)	(117,696)	(1,166,157)	(91,202)	—	—	(1,740,551)
Transfers and write-offs	—	469,952	(60,792,187)	(203,945)	(8,786,978)	(9,034)	(48,468,458)	(117,790,650)
Closing balance . . .	1,022,830	367,493,915	1,141,896,132	9,300,438	340,444,915	5,959,911	51,244,492	1,917,362,633
Accumulated depreciation and impairment losses								
Opening balance . . .	—	238,774,282	871,314,184	6,194,237	309,719,275	5,262,476	—	1,431,264,454
Depreciation of the period (Note 31) . .	—	11,815,702	80,042,417	1,185,568	20,444,348	167,236	—	113,655,271
Disposals	—	(45,589)	(94,879)	(1,034,443)	(65,858)	—	—	(1,240,769)
Transfers and write-offs	—	(4,665,016)	(88,291,419)	(155,750)	(22,505,510)	(6,734)	—	(115,624,428)
Closing balance . . .	—	245,879,379	862,970,303	6,189,612	307,592,255	5,422,978	—	1,428,054,528
Net value	1,022,830	121,614,536	278,925,829	3,110,826	32,852,660	536,933	51,244,492	489,308,105

MEO—Serviços de Comunicações e Multimédia, S.A.
Annex to the Financial Statements (Continued)
As of and for 31 December 2013
(Amounts expressed in Euros)

6. Tangible fixed assets (Continued)

	2012							Total
	Land and natural resources	Buildings and other constructions	Basic equipment	Transportation equipment	Administrative equipment	Other tangible fixed assets	Tangible fixed assets in progress	
	Euro							
Gross value								
Opening balance . . .	1,022,830	349,835,192	1,129,487,744	9,252,705	323,390,947	5,907,194	58,879,724	1,877,776,336
Acquisitions	—	7,270,676	34,816,306	705,678	9,765,698	30,106	50,514,093	103,102,557
Disposals	—	(16,156)	(68,284)	(980,394)	(94,949)	—	—	(1,159,783)
Transfers and write-offs	—	3,919,518	12,935,444	(38,665)	5,662,618	—	(40,394,925)	(17,916,010)
Closing balance . . .	<u>1,022,830</u>	<u>361,009,230</u>	<u>1,177,171,210</u>	<u>8,939,324</u>	<u>338,724,314</u>	<u>5,937,300</u>	<u>68,998,892</u>	<u>1,961,803,100</u>
Accumulated depreciation and impairment losses								
Opening balance . . .	—	227,023,601	803,787,019	5,593,181	288,466,022	5,038,866	—	1,329,908,689
Depreciation of the period (Note 31) . .	—	11,802,448	80,906,266	1,493,905	23,358,750	223,610	—	117,784,979
Disposals	—	(10,271)	(68,271)	(884,331)	(80,800)	—	—	(1,043,673)
Transfers and write-offs	—	(41,496)	(13,310,831)	(8,518)	(2,024,697)	—	—	(15,385,541)
Closing balance . . .	<u>—</u>	<u>238,774,282</u>	<u>871,314,183</u>	<u>6,194,237</u>	<u>309,719,275</u>	<u>5,262,476</u>	<u>—</u>	<u>1,431,264,454</u>
Net value	<u>1,022,830</u>	<u>122,234,948</u>	<u>305,857,027</u>	<u>2,745,087</u>	<u>29,005,039</u>	<u>674,824</u>	<u>68,998,892</u>	<u>530,538,646</u>

As concerns the activity in 2013 and 2012, it is worth noting the investments in tangible fixed assets allocated essentially toward reinforcing mobile data capacity and network quality and expanding the coverage of the 3G/3.5G and 4G networks.

6.2. Other situations relating to tangible fixed assets

In relation to tangible fixed assets, it is worth mentioning that at 31 December 2013, the Company had assets held by third parties in the net amount of 18,027,536 Euros.

7. Goodwill

Goodwill at 31 December 2013 and 2012, in the amount of 10,169,655 Euros, was determined in 2007 following the acquisition of investee PT Wi-Fi, a company that in 2008 was merged into Meo, S.A., as noted in Note 1.

MEO—Serviços de Comunicações e Multimédia, S.A.
Annex to the Financial Statements (Continued)
As of and for 31 December 2013
(Amounts expressed in Euros)

8. Intangible assets

During the years ended 31 December 2013 and 2012, the movement in intangible assets was as follows:

	2013			Total
	Industrial property and other rights	Other intangible assets	Intangible assets in progress	
	Euro			
Gross value				
Opening balance	847,610,560	2,994,846	1,243,424	851,848,830
Acquisitions	32,325,222	(1,101)	64,311	32,388,432
Disposals	(3,887,484)	—	—	(3,887,484)
Transfers and write-offs	(15,386,650)	—	(1,122,201)	(16,508,851)
Closing balance	860,661,648	2,993,745	185,534	863,840,927
Accumulated amortisation and impairment losses				
Opening balance	452,166,760	2,495,398	—	454,662,158
Amortisation (Nota 31)	54,403,423	172,791	—	54,576,214
Disposals	(2,411,218)	—	—	(2,411,218)
Transfers and write-offs	(16,404,324)	—	—	(16,404,324)
Closing balance	487,754,641	2,668,189	—	490,422,830
Intangible assets, net	372,907,007	325,556	185,534	373,418,097
	2012			
	Industrial property and other rights	Other intangible assets	Intangible assets in progress	Total
	Euro			
Gross value				
Opening balance	816,008,835	2,494,179	1,876,767	820,379,781
Acquisitions	37,424,538	91,842	199,317	37,715,697
Disposals	(472,319)	—	—	(472,319)
Transfers and write-offs	(5,350,494)	408,825	(832,660)	(5,774,329)
Closing balance	847,610,560	2,994,846	1,243,424	851,848,830
Accumulated amortisation and impairment losses				
Opening balance	393,156,855	2,394,281	—	395,551,136
Amortisation (Nota 31)	62,900,079	101,117	—	63,001,196
Disposals	(205,202)	—	—	(205,202)
Transfers and write-offs	(3,684,972)	—	—	(3,684,972)
Closing balance	452,166,760	2,495,398	—	454,662,158
Intangible assets, net	395,443,800	499,448	1,243,424	397,186,672

The acquisitions of intangible assets in the years ended 31 December 2013 and 2012 relate fundamentally to the expenses incurred under loyalty programme contracts with customers, which are amortised over their durations.

MEO—Serviços de Comunicações e Multimédia, S.A.
Annex to the Financial Statements (Continued)
As of and for 31 December 2013
(Amounts expressed in Euros)

8. Intangible assets (Continued)

At 31 December 2013, the net book value of “Industrial property and other rights” included essentially:

- An amount of 343 million Euros relating to the 3G and 4G licenses acquired in 2000 and 2011, respectively, corresponding to a gross amount of 500 million Euros net of accrued amortisation of 157 million Euros. The gross amount includes essentially:
 - (i) 133 million Euros relating to the UMTS license acquired in 2000;
 - (ii) 242 million Euros recorded in 2007, pursuant to the commitments assumed in 2000 by Meo, S.A. and the other mobile operators to contribute to the information company during the term of the license, and 11.5 million Euros recorded in 2009 relating to additional commitments under the terms of the UMTS license. At the date the license was assigned it was not possible to reliably determine how these commitments would be fulfilled, such that the Company did not record any asset or liability at that date;
 - (iii) 106 million Euros relating to the 4G license acquired in 2011.
- An amount of 25 million Euros relating to expenses incurred under post-paid mobile services customer loyalty contracts, which are to be amortised over the duration of the respective loyalty programme contracts (2 years); and
- An amount of 3.8 million Euros relating to software usage licenses.

During the years ended 31 December 2013 and 2012, the carrying amount of intangible assets included amounts in respect of personnel expenses of 4,499,166 Euros and 3,933,263 Euros, respectively, relating to own work capitalized.

In 2013 and 2012, the Company undertook research, development and innovation activities under which other operation expenses and fixed assets in the following amounts respectively were recognised:

	2013	2012
	Euro	
Tangible fixed assets	22,525,056	39,471,223
Intangible assets	433,893	976,270
Other operation expenses	3,670,307	3,688,018
Total	<u>26,629,256</u>	<u>44,135,511</u>

9. Financial investments—Equity method of accounting

During the years ended 31 December 2013 and 2012, the movement in this line item was as follows (Note 10.2):

	2013	2012
	Euro	
Investments in subsidiary companies		
Opening balance	5,432,502,015	5,670,077,380
Dividends (Note 4.b)	(67,900,000)	(5,000,000)
Equity method	(346,192,988)	(232,575,365)
Financial investments, net	<u>5,018,409,027</u>	<u>5,432,502,015</u>

MEO—Serviços de Comunicações e Multimédia, S.A.
Annex to the Financial Statements (Continued)
As of and for 31 December 2013
(Amounts expressed in Euros)

9. Financial investments—Equity method of accounting (Continued)

In the years ended 31 December 2013 and 2012, the movement in investments in subsidiary companies stemming from the application of the equity method was recorded as follows:

	2013	2012
	Euro	
Gains in affiliated companies net (Note 24)	194,737,007	68,574,455
Adjustments to financial assets (Note 18)	(540,929,995)	(301,149,820)
	(346,192,988)	(232,575,365)

10. Related parties

10.1. Shareholders and Group companies

At 31 December 2013 and 2012, the detail for “Shareholders and Group companies” under current assets and liabilities consisted of the following:

	2013	2012
	Euro	
DEBIT BALANCES		
Current		
Intercompany loans granted within centralized cash management	8,384,405	—
Accounts receivable from PT SGPS within tax consolidation ^(a)	18,423,167	—
Total debit balances with shareholders and group companies (Note 10.3)	26,807,572	—
CREDIT BALANCES		
Current		
Accounts payable from PT SGPS within tax consolidation ^(a)	—	613,816
Other	2,755,033	2,280,951
Total credit balances with shareholders and group companies (Note 10.3)	2,755,033	2,894,767

(a) In 2013, the line item reflected the amount receivable from PT SGPS corresponding to the difference between the advance payments and withholding effected in 2013 and the estimated IRC for 2013. In 2012, the estimated IRC exceeded advance payments and withholding, such that the company owed IRC to PT SGPS, the parent company for RETGS tax consolidation purposes.

10.2. Financial investments in subsidiary companies

As mentioned in Note 1, the Company is wholly owned by PT Comunicações, which in turn is wholly owned by PT Portugal, which in turn is held by Portugal Telecom. Consequently, all the companies that form part of the PT Group were deemed related parties of Meo, S.A., including not just its own subsidiaries, but also Portugal Telecom’s other subsidiary companies.

MEO—Serviços de Comunicações e Multimédia, S.A.
Annex to the Financial Statements (Continued)
As of and for 31 December 2013
(Amounts expressed in Euros)

10. Related parties (Continued)

The detail, at 31 December 2013 and 2012, of the financial investments in the Company's subsidiaries and the main financial information on these entities is as follows:

2013										
Company name	Headquarters	Assets	Liabilities	Services rendered and sales	Net (Loss) Income	Shareholders' equity	% held	Financial investments (Note 9)	Provision for financial investments (Note 19)	Share on net income (Note 24)
SUBSIDIARIES:										
PT Móveis	Av. Fontes Pereira de Melo, nº 40 1069-300 Lisboa Taguspark—Parque de Ciências e Tecnologia	5,039,111,722	20,702,695	—	194,737,007	5,018,409,027	100.0%	5,018,409,027	—	194,737,007
PT—Sistemas de Informação (PT-SI) ^(a)	Av. Jacques Delors Edifícios Inovação III e IV 2740-122 Porto Salvo	53,092,435	45,842,091	91,795,072	(2,446,656)	7,250,343	0.1%	—	2,779	(2,447)
								<u>5,018,409,027</u>	<u>2,779</u>	<u>194,734,560</u>
2012										
Company name	Headquarters	Assets	Liabilities	Services rendered and sales	Net (Loss) Income	Shareholders' equity	% held	Financial investments (Note 9)	Provision for financial investments (Note 19)	Share on net income (Note 24)
SUBSIDIARIES:										
PT Móveis	Av. Fontes Pereira de Melo, nº 40 1069-300 Lisboa Taguspark—Parque de Ciência e Tecnologia	5,468,958,645	36,456,630	—	68,576,645	5,432,502,015	100.0%	5,432,502,015	—	68,576,645
PT—Sistemas de Informação (PT-SI) ^(a)	Av. Jacques Delors Edifícios Inovação III e IV 2740- 122 Porto Salvo	69,905,903	60,882,617	110,995,705	(3,014,854)	9,023,286	0.1%	—	1,006	(3,015)
								<u>5,432,502,015</u>	<u>1,006</u>	<u>68,573,630</u>

(a) The shareholders' equity of this company includes ancillary contributions (*prestações acessórias*) in the amount of 10,028,970 Euros.

MEO—Serviços de Comunicações e Multimédia, S.A.
Annex to the Financial Statements (Continued)
As of and for 31 December 2013
(Amounts expressed in Euros)

10. Related parties (Continued)

The nature and details of the main credit balances with related parties at 31 December 2013 and 2012 are as follows:

	2013						
	Shareholders and Group companies (Note 10.1)	Suppliers	Investment suppliers	Accrued expenses	Deferrals	Other accounts payable (Note 17)	Total accounts payable
	euros						
PT Comunicações	2,753,989	38,051,789	889,662	33,608,523	53,090	74,946	75,431,999
PT SGPS	—	32,976	—	7,654	—	—	40,630
PT Contact	—	5,381,039	—	19,506,509	528	404	24,888,480
PT—SI	1,044	3,900,830	1,797,876	433,047	1,120	43,178	6,177,095
PT Inovação	—	1,418,626	3,398,356	39,663	81	1	4,856,727
PT Centro Corporativo	—	4,097,201	—	(974,116)	(3,257)	—	3,119,828
PT PRO	—	2,149,359	27,428	221,981	(7,798)	1,290	2,392,260
UNITEL	—	800,356	—	—	—	—	800,356
Other companies	—	1,443,202	—	(1,722,071)	126,559	5,133	(147,177)
	<u>2,755,033</u>	<u>57,275,378</u>	<u>6,113,322</u>	<u>51,121,190</u>	<u>170,323</u>	<u>124,952</u>	<u>117,560,198</u>

	2012							
	Loans obtained (Note 20)	Shareholders and Group companies (Note 10.1)	Suppliers	Investment suppliers	Accrued expenses	Deferrals	Other accounts Payable (Note 17)	Total accounts payable
	euros							
PT Comunicações	340,000,000	2,280,891	63,656,961	1,264,587	42,387,020	85,776	55,358	449,730,593
PT SGPS	37,803,523	613,816	525,647	—	82,291	—	—	39,025,277
PT Contact	—	—	9,332,546	—	12,947,303	1,114	153	22,281,116
PT Inovação	—	—	2,019,091	3,865,267	45,290	12	—	5,929,660
PT—SI	—	60	2,502,510	1,717,686	934,118	1,253	907	5,156,534
UNITEL	—	—	4,932,298	—	—	—	—	4,932,298
PT Centro Corporativo	—	—	1,581	683	3,539,650	(232)	—	3,541,682
PT PRO	—	—	1,854,742	30,806	143,277	8,132	200	2,037,157
Other companies	—	—	689,803	—	(2,021,576)	88,238	(2,017)	(1,245,552)
	<u>377,803,523</u>	<u>2,894,767</u>	<u>85,515,179</u>	<u>6,879,029</u>	<u>58,057,373</u>	<u>184,293</u>	<u>54,601</u>	<u>531,388,765</u>

MEO—Serviços de Comunicações e Multimédia, S.A.
Annex to the Financial Statements (Continued)
As of and for 31 December 2013
(Amounts expressed in Euros)

10. Related parties (Continued)

In the years ended 31 December 2013 and 2012, the nature and details of the main transactions with related parties are as follows:

	2013						
	Sales and services rendered	Costs of services rendered	Supplies and external services	Wages and salaries ^(a)	Other operating income and gain	Other operating expenses and losses	Net interest expenses
	Euro						
PT Comunicações	157,093,899	(126,458,306)	(29,936,990)	(4,827,835)	585,721	(2,102,956)	(2,936,476)
SIRESP Gestão Redes Digitais Segurança Emergência, SA	9,151,084	—	(21,930)	80,128	4,986,970	—	—
UNITEL	2,147,461	(1,448,566)	—	—	211,457	(203,339)	—
CV Móvel	742,082	(321,675)	—	—	23,705	(15,586)	—
Timor Telecom	724,866	(47,431)	—	7,440	1,988	(1,353)	—
PT—SI	675,546	(1,238)	(11,589,407)	1,958,679	—	801	—
PT Centro Corporativo	551,037	—	(20,047,940)	89,063	—	—	—
PT PRO	363,821	—	(9,282,246)	1,894,582	—	(4,151)	—
PT Inovação	291,724	—	(4,656,495)	34,759	—	(17,970)	—
PT Contact	201,724	0	(41,687,787)	2,026,885	0	0	—
CST	197,423	(119,296)	—	—	56,217	(8,893)	—
Other companies	676,761	(754,466)	(13,190)	1,751,857	84,143	(1,904,629)	(641,050)
	172,817,428	(129,150,978)	(117,235,985)	3,015,558	5,950,201	(4,258,076)	(3,577,526)
	2012						
	Sales and services rendered	Costs of services rendered	Supplies and external services	Wages and salaries ^(a)	Operating income and gain	Operating expenses and losses	Net interest expenses
	Euro						
PT Comunicações	107,445,442	(139,562,905)	(17,932,147)	(4,750,806)	610,843	(1,901,750)	(14,543,063)
SIRESP Gestão Redes Digitais Segurança Emergência, SA	8,880,580	(14,558)	(114)	86,010	4,235,896	—	—
UNITEL	1,781,222	(2,196,594)	—	—	136,938	(37,933)	—
CV Móvel	1,120,850	(404,413)	—	—	17,990	(32,906)	—
PT—SI	688,065	—	(15,740,207)	1,963,519	—	—	—
Timor Telecom	551,873	(96,764)	—	—	13,152	(372)	—
PT Centro Corporativo	450,597	—	(22,964,195)	106,051	—	7,728	—
PT PRO	407,283	—	(8,749,337)	1,786,252	—	(499)	—
PT Inovação	363,785	(77)	(4,706,860)	(13,874)	—	(17,970)	—
PT Contact	258,515	—	(37,074,794)	1,599,493	—	108	—
CST	176,890	(194,974)	—	—	12,530	(8,486)	—
Other companies	1,148,633	(680,559)	(12,344)	1,584,746	75,736	(1,875,786)	(1,665,098)
	123,273,735	(143,150,844)	(107,179,998)	2,361,391	5,103,085	(3,867,866)	(16,208,161)

(a) This line item includes personnel assigned to other companies in the Portugal Telecom Group, in the amounts of 6,855,925 Euros in 2013 and 6,348,474 Euros in 2012, which were invoiced to these entities and recognised as a deduction to “Wages and salaries.” The expenses supported by the Company on personnel assigned by other companies in the Portugal Telecom Group refer essentially to personnel assigned by PT Comunicações, which amounted to 4,163,590 Euros in 2013 and 4,233,652 Euros in 2012.

10.4. Other information

The compensation attributed to members of the Company’s corporate organs in the years ended 31 December 2013 and 2012 amounted to 40,000 Euros in both years and refer exclusively to fees for the legal review of accounts allocated to the Fiscal Council.

Compensation of the members of the Board of Directors is to be borne in full by PT Portugal.

MEO—Serviços de Comunicações e Multimédia, S.A.
Annex to the Financial Statements (Continued)
As of and for 31 December 2013
(Amounts expressed in Euros)

11. Deferrals

These line items consisted of the following at 31 December 2013 and 2012:

	2013	2012
	Euro	
PREPAID EXPENSES		
Current		
Direct costs	5,021,745	4,974,597
Maintenance	2,001,044	2,745,797
Rentals	338,419	311,317
Marketing and publicity	1,750	1,411,866
Other	136,318	315,839
Total prepaid expenses	7,499,276	9,759,416
DEFERRED INCOME		
Current		
Advance billing	26,574,634	30,925,007
Customer Loyalty Program	7,901,416	12,073,209
Penalties imposed to customers relating to violations of contracts	6,234,237	7,866,182
Other	752,008	1,416,867
Total deferred income	41,462,295	52,281,265

12. Other financial assets and liabilities

These line items consisted of the following at 31 December 2013 and 2012:

	2013	2012
	Euro	
OTHER FINANCIAL ASSETS		
Non-Current		
Accounts receivable—trade (Note 15)	128,127	15,847
Other	3,891	1,955
Total non-current	132,018	17,802
OTHER FINANCIAL LIABILITIES		
Non-Current		
Dismantling and removal of assets ^(a)	18,366,291	32,705,960
Other	5,804,014	2,226,418
Total non-current	24,170,305	34,932,378

(a) At 31 December 2013 and 2012, this line item reflects obligations to dismantle and remove assets installed on others' property and to restore the respective premises (Note 3.11).

MEO—Serviços de Comunicações e Multimédia, S.A.
Annex to the Financial Statements (Continued)
As of and for 31 December 2013
(Amounts expressed in Euros)

13. Income taxes

13.1. Framework

As of 1 January 2013, pursuant to a change in tax law in December of 2012, companies generally became subject to income tax under the *Imposto sobre o Rendimento das Pessoas Coletivas* (IRC) at the rate of 25%, plus (i) a municipal tax of up to 1.5% of the IRC tax base and (ii) a state tax of 3%, applicable to the tax base between 1.5 and 7.5 million Euros, and 5%, applicable to the tax base in excess of 7.5 million Euros (this limit was 10 million Euros in 2012), resulting in a maximum aggregate rate of approximately 31.5% for taxable profits in excess of 7.5 million Euros.

As of 2014, companies located in Continental Portugal will be taxed under the IRC at a base rate of 23%, plus (i) a Municipal Tax of up to 1.5% on the tax base, and (ii) a State Tax of 3.0% applicable to taxable profits between 1.5 and 7.5 million Euros, 5.0% applicable to taxable profits between 7.5 and 35 million Euros, and 7.0% applicable to taxable profits in excess of 35 million Euros, resulting in a maximum aggregate rate of approximately 31.5% for taxable profits in excess of 35 million Euros.

The Company's tax profit in 2013 and 2012 exceeded the 7.5 and 10 million Euro limits mentioned above, such that the Company applied a tax rate of 31.5% to calculate the income tax estimates, having corrected the effect of the tax rates applicable to taxable profit up to the above-referenced limits.

In calculating the taxable income to which the above-referenced tax rate is applied, excluded tax expenses and revenues are added to or deducted from accounting income.

The Company participates in the *Regime Especial de Tributação dos Grupos de Sociedades* ("RETGS") tax consolidation, where the parent company is PT SGPS, such that estimated income taxes and withholding effected by third parties are recorded on the balance sheet as PT SGPS accounts payable and receivable.

In accordance with applicable law, tax returns are subject to review and correction by the tax authorities for four years (five years for Social Security) except when there have been tax losses, when tax benefits have been conceded, or there are ongoing audits, complaints or challenges, in which cases, depending on the circumstances, the periods are extended or suspended. The Company's Board of Directors, as supported by information from its tax advisors, believes that any tax contingencies should not significantly affect the financial statements as of and for 31 December 2013, considering the provisions constituted and the existing expectations at the date hereof with respect to the resolution of the tax contingencies described in Note 19.

13.2. Deferred taxes

In measuring the expense relating to income taxes for the year, in addition to the current tax as determined based on income before taxes as adjusted in accordance with tax law, the effects resulting from temporary differences between income before taxes and taxable profits, originating in the year or in years prior, are also taken into account.

MEO—Serviços de Comunicações e Multimédia, S.A.
Annex to the Financial Statements (Continued)
As of and for 31 December 2013
(Amounts expressed in Euros)

13. Income taxes (Continued)

The movement in deferred tax assets during the years ended 31 December 2013 and 2012 was as follows:

	2013					Total
	Impairment of accounts receivable	Depreciation and amortisation of tangible assets	Impairment of inventories	Other provision and adjustments	Other temporary differences	
	Euro					
Opening balance	6,673,770	16,650,574	1,079,238	21,895,569	713,721	47,012,872
Increases (reductions)						
Net income	(2,850,133)	(2,704,060)	(98,428)	(5,735,394)	887,011	(10,501,004)
Shareholders' equity . . .	—	—	—	—	233,731	233,731
Closing balance	<u>3,823,637</u>	<u>13,946,514</u>	<u>980,810</u>	<u>16,160,175</u>	<u>1,834,463</u>	<u>36,745,599</u>
	2012					
	Impairment of accounts receivable	Depreciation and amortisation of tangible assets	Impairment of inventories	Other provision and adjustments	Other temporary differences	Total
	Euro					
Opening balance	—	20,501,141	—	22,775,930	736,725	44,013,796
Increases (reductions)						
Net income	6,673,770	(3,850,567)	1,079,238	(880,361)	(49,216)	2,972,864
Shareholders' equity . . .	—	—	—	—	26,212	26,212
Closing balance	<u>6,673,770</u>	<u>16,650,574</u>	<u>1,079,238</u>	<u>21,895,569</u>	<u>713,721</u>	<u>47,012,872</u>

The movement in deferred tax liabilities during the years ended 31 December 2013 and 2012 was as follows:

	2013
	Other temporary differences
	Euro
Opening balance	212,773
Increases (reductions)	
Net income	(106,387)
Closing balance	<u>106,386</u>
	2012
	Other temporary differences
	Euro
Opening balance	319,159
Increases (reductions)	
Net income	(106,386)
Closing balance	<u>212,773</u>

MEO—Serviços de Comunicações e Multimédia, S.A.
Annex to the Financial Statements (Continued)
As of and for 31 December 2013
(Amounts expressed in Euros)

13. Income taxes (Continued)

13.3. Tax rate reconciliation

In the years ended 31 December 2013 and 2012, the reconciliation between the theoretical amount resulting from applying the nominal tax rate to income before taxes and the income tax expense is as follows:

	2013	2012
	Euro	
Income before taxes	396,092,472	331,654,062
Nominal tax rate	31.5%	31.5%
Expected tax	124,769,129	104,471,030
Permanent differences ⁽ⁱ⁾	(62,547,845)	(22,024,852)
Reversal of deferred taxes from previous years	1,629,471	(4,533,837)
Surplus of prior year accrued income tax	(3,980,526)	2,132,056
Other	76,064	35,476
	59,946,293	80,079,873
Income tax		
Income tax-current	49,551,676	83,159,123
Deferred tax	10,394,617	(3,079,250)
	59,946,293	80,079,873

(i) Permanent differences consist of the following:

	2013	2012
	Euro	
Equity method of accounting (Note 24)	(194,734,560)	(68,573,630)
Tax benefits	(978,486)	(1,057,306)
Recognition of capital gains and losses	331,367	(8,342)
Provisions and adjustments not deductible for tax purposes	(1,993,569)	840,940
Other	(1,189,340)	(1,121,826)
	(198,564,588)	(69,920,164)
Nominal tax rate	31.5%	31.5%
	(62,547,845)	(22,024,852)

13.4. Other Information

In accordance with Law 40/2005, of 3 August, which approved the SIFIDE—*Sistema de Incentivos Fiscais em Investigação e Desenvolvimento Empresarial*, the Company applied in 2013 for business research and development tax incentives relating to 2012 in the amount of 572,669 Euros.

Under Law 10/2009 of 10 March, which approved the RFAI—*Regime Fiscal de Apoio ao Investimento*, the Company's periodic income tax return for 2012 included a deduction in the amount of 2,344,049 Euros, based on significant investments in new generation broadband networks.

During the 2013 financial year, Law 49/2013, of 16 July 2013, established a *Crédito Fiscal Extraordinário ao Investimento*, which is a deduction from IRC collection in the amount of 20% of investment expenses relating to operating assets carried out after 1 June 2013. In companies participating in RETGS tax consolidation, the deduction will be effected based on the tax base of the Group and the limitations provided in the law, and amounts that cannot be deducted can be utilised in the five subsequent tax periods, under the same conditions. The Company is evaluating whether it will use this benefit or not, as

MEO—Serviços de Comunicações e Multimédia, S.A.
Annex to the Financial Statements (Continued)
As of and for 31 December 2013
(Amounts expressed in Euros)

13. Income taxes (Continued)

a function of investment made in 2013 in the maximum amount of 5,008,055.93 Euros that can be considered eligible, and for this reason has not reflected this situation in the financial statements.

14. Inventories

This line item consisted of the following at 31 December 2013 and 2012:

	2013			2012		
	Gross value	Impairment losses	Net value	Gross value	Impairment losses	Net value
	Euro					
Goods	39,732,401	(15,955,792)	23,776,609	34,344,331	(14,459,940)	19,884,391
Raw materials and consumables	1,587,017	(218,116)	1,368,901	1,584,085	(121,895)	1,462,190
	41,319,418	(16,173,908)	25,145,510	35,928,416	(14,581,835)	21,346,581

In 2013 and 2012, the costs of products sold and materials consumables were determined as follows:

	2013			2012		
	Goods	Materials	Total	Goods	Materials	Total
	Euro					
Opening balance	34,344,331	1,584,085	35,928,416	43,860,085	1,607,738	45,467,823
Purchases	153,919,624	402,758	154,322,382	126,406,613	412,345	126,818,958
Adjustments	(38,258,322)	2,349,957	(35,908,365)	(31,080,007)	2,098,589	(28,981,418)
Closing balance	39,732,401	1,587,017	41,319,418	34,344,331	1,584,085	35,928,416
Costs of products sold and materials consumables	110,273,232	2,749,783	113,023,015	104,842,360	2,534,587	107,376,947

The accrued inventory impairment losses in the years ended 31 December 2013 and 2012 were as follows:

	2013			2012		
	Goods	Materials	Total	Goods	Materials	Total
	Euro					
Opening balance	14,459,940	121,895	14,581,835	18,365,977	276,919	18,642,896
Increases	2,763,151	96,221	2,859,372	11,551	—	11,551
Reversals	(1,267,299)	—	(1,267,299)	(3,917,588)	(155,024)	(4,072,612)
Closing balance	15,955,792	218,116	16,173,908	14,459,940	121,895	14,581,835

15. Accounts receivable and unbilled revenues

At 31 December 2013 and 2012, these line items consisted of the following:

	2013			2012		
	Gross value	Impairment losses	Net value	Gross value	Impairment losses	Net value
	Euro					
Trade accounts receivable— current assets	329,562,219	(85,831,116)	243,731,103	295,799,651	(93,909,837)	201,889,814
Trade accounts receivable— non-current assets (Note 12)	128,127	—	128,127	15,847	—	15,847
Accounts receivable	329,690,346	(85,831,116)	243,859,230	295,815,498	(93,909,837)	201,905,661
Unbilled revenues	90,207,873	—	90,207,873	104,201,086	—	104,201,086
	419,898,219	(85,831,116)	334,067,103	400,016,584	(93,909,837)	306,106,747

MEO—Serviços de Comunicações e Multimédia, S.A.
Annex to the Financial Statements (Continued)
As of and for 31 December 2013
(Amounts expressed in Euros)

15. Accounts receivable and unbilled revenues (Continued)

In the years ended 31 December 2013 and 2012, the change in accrued impairment losses on debts receivable from clients was as follows:

	2013	2012
	Euro	
Opening balance	93,909,837	98,875,939
Increases (reversals)	9,832,211	11,166,860
Utilizations ^(a)	(17,910,932)	(16,132,962)
Closing balance	<u>85,831,116</u>	<u>93,909,837</u>

(a) This line item refers to the use of accrued impairment losses to face of credits of doubtful collection that were deemed uncollectible and that were fully adjusted.

The Company is exposed to credit risk due to the possibility a counterparty might not fulfil its contractual obligations, resulting in financial loss. Credit risk relates essentially to accounts receivable for services rendered to clients and is monitored regularly with the following objectives: (a) limiting the credit extended to clients, considering the respective profile and the age of the accounts receivable; (b) monitoring trends in the level of credit extended; (c) regularly testing for impairment of amounts receivable; and (d) analyzing market risk where the client is located. The Company is not exposed to any significant credit risk relating to any particular client, as its accounts receivable derive from a large number of clients.

At 31 December 2013 and 2012, the age of client accounts receivable, net of impairment losses, was as follows:

	2013			2012		
	Accounts receivable from group companies	Accounts receivable from other companies	Total	Accounts receivable from group companies	Accounts receivable from other companies	Total
	Euro					
Unexpired balance	83,563,701	42,809,016	126,372,717	21,994,249	40,473,715	62,467,964
Expired balance						
0-60 days	1,885,313	14,299,812	16,185,125	3,626,042	24,364,021	27,990,063
60-90 days	684,849	2,135,507	2,820,356	1,109,927	3,587,679	4,697,606
90-180 days	834,315	4,051,858	4,886,173	1,601,762	5,496,429	7,098,191
180-360 days	543,243	5,500,154	6,043,397	(353,868)	9,569,072	9,215,204
360-720 days	(125,678)	5,620,149	5,494,471	1,706,213	5,014,934	6,721,147
More than 720 days	1,005,415	81,051,576	82,056,991	1,013,634	82,701,852	83,715,486
Accounts receivable	<u>88,391,158</u>	<u>155,468,072</u>	<u>243,859,230</u>	<u>30,697,959</u>	<u>171,207,702</u>	<u>201,905,661</u>

16. State and other public entities

As of 31 December 2013 and 2012, the debit and credit balances with the State and Other Public Entities were as follows:

	2013		2012	
	Debit balances	Credit balances	Debit balances	Credit balances
	Euro			
Value added tax	—	23,691,396	—	8,731,468
Social security taxes	—	982,036	—	896,308
Personnel income taxes	—	980,507	—	723,989
Other taxes	991	24,448	275,246	10,043
	<u>991</u>	<u>25,678,387</u>	<u>275,246</u>	<u>10,361,808</u>

MEO—Serviços de Comunicações e Multimédia, S.A.
Annex to the Financial Statements (Continued)
As of and for 31 December 2013
(Amounts expressed in Euros)

17. Other accounts receivable and payable

As of 31 December 2013 and 2012, these line items consisted of the following:

	2013	2012
	Euro	
OTHER ACCOUNTS RECEIVABLE		
Current		
Group companies (Note 10.3)	321,140	943,457
Other accounts receivable	8,107,161	9,367,525
Total other accounts receivable	8,428,301	10,310,982
OTHER ACCOUNTS PAYABLE		
Non-Current		
License LTE ^(a)	14,840,169	19,082,848
Total non-current	14,840,169	19,082,848
Current		
Commitments related to the license UMTS	8,354,115	35,555,145
License LTE ^(a)	6,000,000	6,000,000
Commissions payable to agents	2,128,921	3,293,131
Group companies (Note 10.3)	124,952	54,601
Other accounts payable	2,517,259	3,430,361
Total current	19,125,247	48,333,238
Total other accounts payable	33,965,416	67,416,086

(a) These items correspond to the present value of the amounts owed in the context of the acquisition of the 4G license, completed in December 2011. The payment plan established for the amounts owed at 31 December 2013 provides for payment in 4 annual instalments of 6 million Euros each, the last is payable in January 2017, for an aggregate of 24 million Euros, where the present value at 31 December 2013 amounts to 20,840,169 Euros.

18. Shareholders' equity

18.1. Share capital

As of 31 December 2013 and 2012, the Company's share capital was fully subscribed and paid-in, amounting to 47,000,000 Euros, and was represented by 9,400,000 book-entry shares, with a nominal value of 5 Euros each. The Company's share capital is wholly held by PT Comunicações (Note 1).

18.2. Legal reserve

Commercial law and the Company's bylaws establish that at least 5% of annual net income must be allocated to reinforce the legal reserve until it represents 20% of the share capital. This reserve cannot be distributed other than in the event of the liquidation of the company, but can be utilised to absorb losses, after exhausting all other reserves, or for incorporation in the capital.

As of 31 December 2013 and 2012, the legal reserve was fully constituted in accordance with applicable commercial law, amounting to 9,400,000 Euros.

MEO—Serviços de Comunicações e Multimédia, S.A.
Annex to the Financial Statements (Continued)
As of and for 31 December 2013
(Amounts expressed in Euros)

18. Shareholders' equity (Continued)

18.3. Adjustments to financial assets

During the years ended 31 December 2013 and 2012, the movement in this line item was as follows:

	Unpaid dividends	Foreign currency exchange differences ^(a)	Other changes in shareholders' equity ^(b)	Total
	Euro			
Balance as at 1 January 2012	5,689,039,641	(229,436,015)	(404,029)	5,459,199,597
Equity method	—	(350,110,383)	48,960,382	(301,150,001)
Dividends not received from PT Móveis	45,340,711	—	—	45,340,711
Balance as at 31 December 2012	5,734,380,352	(579,546,398)	48,556,353	5,203,390,307
Equity method	—	(534,610,065)	(6,319,256)	(540,929,321)
Dividends not received from PT Móveis	676,645	—	—	676,645
Balance as at 31 December 2013	5,735,056,997	(1,114,156,463)	42,237,097	4,663,137,631

(a) This line item basically reflects the Company's interest in changes in shareholders' equity in PT Móveis other than those arising from the interest in the net (loss)/income of this investee. In 2013 and 2012, this line item reflected essentially negative adjustments for exchange rate conversion, due to the depreciation of the Brazilian *Real* against the Euro in the investment held indirectly in the Oi Group, which was acquired on 28 March 2011 by Bratel Brasil, as noted in Note 1.

(b) In 2012, the other changes in shareholders' equity due to application of the equity method relate essentially to a gain recorded by Bratel Brasil, in the amount of 49 million Euros, relating to the Oi Group's corporate reorganisation in March 2012.

The variations relating to application of the equity method were recorded by counter-entry for the appreciated financial investments in accordance with the equity method as follows:

	2013	2012
	Euro	
Investments in subsidiaries and associated companies (Note 9)	(540,929,995)	(301,149,820)
Provision for negative financial investments (Note 19)	674	(181)
	(540,929,321)	(301,150,001)

18.4. Allocation of earnings

In 2012, as resolved at the General Shareholders' Meeting held on 28 March 2012, the net earnings for 2011, in the total amount of 285,819,986.56 Euros, were allocated as follows: (1) 235,479,275.19 Euros for dividend distribution, and (2) 50,340,711.37 Euros for retained earnings.

In 2013, as resolved at the General Shareholders' Meeting held on 27 March 2013, the entire net earnings for 2012, in the total amount of 251,574,188.89 Euros, were transferred to "Retained earnings."

MEO—Serviços de Comunicações e Multimédia, S.A.
Annex to the Financial Statements (Continued)
As of and for 31 December 2013
(Amounts expressed in Euros)

19. Provisions, contingent liabilities and contingent assets

19.1. Movements in the provisions

During the years ended 31 December 2013 and 2012, the movements in the provisions were as follows:

	2013				Total
	Tax claims	Other litigation	Provision for negative financial investments (Note 10)	Other provisions	
	Euro				
Opening balance	3,583,639	10,981,608	1,006	4,911,670	19,477,923
Increases	754,139	—	1,773	1,977,312	2,733,224
Reductions	(979,369)	(131,790)	—	—	(1,111,159)
Utilizations	(2,084,779)	—	—	—	(2,084,779)
Closing balance	1,273,630	10,849,818	2,779	6,888,982	19,015,209

	2012				Total
	Tax claims	Other Litigation	Provision for negative financial investments (Note 10)	Other provisions	
	Euro				
Opening balance	3,613,271	11,284,872	—	5,043,895	19,942,038
Increases	1,461,158	—	1,006	—	1,462,164
Reductions	(628,805)	(303,264)	—	(132,225)	(1,064,294)
Utilizations	(33,063)	—	—	—	(33,063)
Other movements	(828,922)	—	—	—	(828,922)
Closing balance	3,583,639	10,981,608	1,006	4,911,670	19,477,923

The provisions for negative financial investments are allocated to deal with losses in investee companies that have negative shareholders' equity (Note 10), and are calculated as a function of the percentage of interest in the capital of these companies. The movements in these provisions during the years ended 31 December 2013 and 2012 were as follows:

	2013	2012
	Euro	
Losses in subsidiaries and associated companies (Note 24)	2,447	825
Adjustments to financial assets (Note 18)	(674)	181
	1,773	1,006

19.2. Proceedings with probable losses

The provisions for taxes are allocated to handle various tax contingencies relating to IRC and Social Security, among other taxes and charges.

The provisions for ongoing judicial proceedings are allocated to handle liabilities arising from proceedings brought against the Company, estimated based on information from its lawyers.

At 31 December 2013 and 2012, the Company, in accordance with NCRF 21 *Provisões, Passivos Contingentes e Ativos Contingentes* ("NCRF 21") and based on the opinion of internal and external legal counsel, had classified a variety of ongoing judicial and arbitral actions and tax contingencies as

MEO—Serviços de Comunicações e Multimédia, S.A.
Annex to the Financial Statements (Continued)
As of and for 31 December 2013
(Amounts expressed in Euros)

19. Provisions, contingent liabilities and contingent assets (Continued)

proceedings with probable losses, to bear the probable outflow of resources as a result of these proceedings. The nature of these proceedings is as follows:

	<u>2013</u>	<u>2012</u>
	Euro	
Legal proceedings		
Civil contingencies	10,245,469	10,084,018
Labor contingencies	24,632	286,871
Other contingencies	579,717	610,719
	<u>10,849,818</u>	<u>10,981,608</u>
Tax contingencies	1,273,630	3,583,639
	<u>12,123,448</u>	<u>14,565,247</u>

19.3. Proceedings with possible losses

At 31 December 2013 and 2012, the Company, in accordance with NCRF 21 and based on the opinion of internal and external legal counsel, had classified a variety of ongoing judicial and arbitral actions and tax contingencies as proceedings with possible losses. The nature of these proceedings is as follows:

	<u>2013</u>	<u>2012</u>
	Euro	
Legal proceedings		
Civil contingencies ^(a)	780,759	8,203,539
Labor contingencies	1,683	—
Other contingencies	2,180,597	3,869,544
	<u>2,963,039</u>	<u>12,073,083</u>

(a) At 31 December 2012, this line item included a Noxitel proceeding in the amount of 6,000,000 Euros, regarding breach of contract, which ended in 2013 without any penalty for the Company.

The Board of Directors believes that any corrections resulting from audits/inspections of tax returns by the tax authorities will not have a significant effect on the financial statements as of and for 31 December 2013, considering the provisions constituted and the expectations at the date hereof with respect to the final resolution of the above-referenced matters.

19.4. Other proceedings

The Company received additional IRC assessments relating to the financial years from 2004 to 2010, and the tax audit report relating to 2010, which essentially question the deductibility of certain financial costs, in the total amount of 204 million Euros of taxes. The Company disagrees with these assessments and conclusions, and considers, based on the opinion of its tax counsel, that there are solid arguments to oppose the position of the tax authorities.

19.5. Contingent assets

The value of contingent assets at 31 December 2013 amounted to approximately 4.6 million Euros, referring essentially to proceedings brought by the company against third parties, relating to situations of breach of 2G equipment sales contracts, service provision and lack of payment for Wi-Fi service.

MEO—Serviços de Comunicações e Multimédia, S.A.
Annex to the Financial Statements (Continued)
As of and for 31 December 2013
(Amounts expressed in Euros)

20. Loans obtained

Loans obtained as of 31 December 2013 and 2012 consisted of the following:

	2013		2012	
	Non-current	Current	Non-current	Current
	Euro			
Intragroup loans (Note 10)	—	—	340,000,000	—
Centralized cash management (Note 10) .	—	—	—	37,803,523
Commercial programme	230,000,000	20,000,000	—	—
Other financings	—	2,020,914	—	21,719
Leases	1,429,085	1,239,737	1,311,519	2,577,104
	<u>231,429,085</u>	<u>23,260,651</u>	<u>341,311,519</u>	<u>40,402,346</u>

20.1. Intragroup loans

In June 2010, the Company obtained advances from PT Portugal, its previous shareholder, in the amount of 500,000,000 Euros, which did not have an established maturity. On 30 November 2010, these advances were assigned by PT Portugal to PT Comunicações at their respective nominal amount, in the context of the sale by the former to the latter of the financial interest in Meo, S.A. On 2 December 2011, the Company repaid the amount of 160,000,000 Euros relating to these advances and on 1 March 2013 it repaid the remaining 340,000,000 Euros (Note 4).

20.2. Centralised cash management

As of March 2006, Portugal Telecom began to centralise all receipts and payments of the Group companies headquartered in Portugal. The loans obtained by the Company pursuant to this centralized cash management system have short-term maturities and bear interest at market rates.

20.3. Commercial paper programme

On 25 June 1999, Portugal Telecom established a Framework Agreement for the Issuance of Commercial Paper, in which the Company participates, which was amended several times and had, at 31 December 2013, a maximum amount of 3,500,000,000 Euros. The agreement is in effect until 7 July 2015, and is automatically renewable for successive 2-year periods, until 7 July 2025, except if terminated by any of the parties.

On 1 June 2000, Portugal Telecom established a Framework Agreement for the Issuance of Commercial Paper, in which the Company participates, which was amended several times and had, at 31 December 2013, a maximum amount of 3,000,000,000 Euros. The contract is in effect until 1 June 2014, and is automatically renewable for successive 2-year periods, until 1 June 2020, except if terminated by any of the parties.

At 31 December 2012, the Company was not using any amount under these programmes. During 2013, the Company used an amount of 250,000,000 Euros (Note 4), which was outstanding at the end of the year.

20.4. Leases

Financial lease obligations result essentially from: (i) vehicle leases, which generally include purchase options; and (ii) rights to use transmission capacity over fibre optic circuits.

MEO—Serviços de Comunicações e Multimédia, S.A.
Annex to the Financial Statements (Continued)
As of and for 31 December 2013
(Amounts expressed in Euros)

20. Loans obtained (Continued)

As of 31 December 2013 and 2012, the Company had recorded the following assets in the balance sheet under the financial lease regime:

	2013			2012		
	Gross value	Accumulated depreciation	Carrying value	Gross value	Accumulated depreciation	Carrying value
Euro						
Tangible fixed assets						
Transport equipment	3,940,616	1,595,861	2,344,755	4,797,856	2,986,250	1,811,606
Other tangible fixed assets	736,562	433,200	303,362	737,926	272,224	465,702
	<u>4,677,178</u>	<u>2,029,061</u>	<u>2,648,117</u>	<u>5,535,782</u>	<u>3,258,474</u>	<u>2,277,308</u>
Intangible assets						
Industrial property and other rights	2,864,046	2,266,332	597,714	2,864,046	1,311,650	1,552,396
	<u>7,541,224</u>	<u>4,295,393</u>	<u>3,245,831</u>	<u>8,399,828</u>	<u>4,570,124</u>	<u>3,829,704</u>

The maturity of the minimum payments for the financial leases at 31 December 2013 and 2012 was as follows:

	2013			2012		
	Capital	Interest	Total	Capital	Interest	Total
Euro						
Up to 1 year	1,239,737	97,059	1,336,796	2,577,104	203,515	2,780,619
Between 1 and 2 years	713,538	45,516	759,054	671,392	48,671	720,063
Between 2 and 3 years	291,938	26,549	318,487	501,782	14,337	516,119
Between 3 and 4 years	250,342	15,016	265,358	67,735	5,397	73,132
Between 4 and 5 years	121,090	6,365	127,455	70,610	1,667	72,277
More than 5 years	52,177	393	52,570	—	—	—
	<u>2,668,822</u>	<u>190,898</u>	<u>2,859,720</u>	<u>3,888,623</u>	<u>273,587</u>	<u>4,162,210</u>

21. Suppliers

At 31 December 2013 and 2012, “Trade Suppliers” and “Investment suppliers” line items consisted of the following:

	2013	2012
	Euro	
Trade suppliers		
Current	162,474,110	209,491,363
Invoices to be issued	4,320,533	4,901,774
	<u>166,794,643</u>	<u>214,393,137</u>
Investment suppliers		
Current	24,020,629	46,601,212
Invoices to be issued	3,893,380	1,792,312
	<u>27,914,009</u>	<u>48,393,524</u>

MEO—Serviços de Comunicações e Multimédia, S.A.
Annex to the Financial Statements (Continued)
As of and for 31 December 2013
(Amounts expressed in Euros)

22. Accrued expenses

At 31 December 2013 and 2012, this line item consisted of the following:

	2013	2012
	Euro	
Support services	55,519,444	48,931,816
Commissions	32,235,530	20,123,148
Direct costs of services rendered	19,565,533	18,013,062
Other supplies and external services	11,333,716	9,379,785
Litigation and Notaries	9,014,706	1,227,675
Charges for vacations, vacation subsidies and other payroll costs . . .	6,576,148	6,179,096
Specialized work	6,338,406	5,817,463
Interest and other financial expenses payable ^(a)	1,836,321	27,519,410
Other	5,362,407	2,298,645
	147,782,211	139,490,100

(a) The decrease in the balance of this line item relates essentially to repayment of advances to PT Comunicações (Note 20.1).

23. Services rendered and sales

In the years ended 31 December 2013 and 2012, these line items consisted of the following:

	2013	2012
	Euro	
Services rendered		
Billing	888,263,041	977,459,009
Interrelation	53,019,889	68,409,374
Operators roaming	10,733,634	18,749,961
Sales	102,547,893	88,691,659
	1,054,564,457	1,153,310,003

24. Equity in earnings of affiliated companies

In the years ended 31 December 2013 and 2012, the gains and losses in affiliated companies, arising from application of the equity method of accounting (Notes 10.2 and 13.3), were recognised through counter-entries to the following line items:

	2013	2012
	Euro	
Financial investments (Note 9)		
PT Móveis	194,737,007	68,576,645
PT Sistemas de Informação	—	(2,190)
	194,737,007	68,574,455
Provision for negative financial investments (Note 19)		
PT Sistemas de Informação	(2,447)	(825)
	194,734,560	68,573,630

MEO—Serviços de Comunicações e Multimédia, S.A.
Annex to the Financial Statements (Continued)
As of and for 31 December 2013
(Amounts expressed in Euros)

25. Direct costs

In the financial years ended 31 December 2013 and 2012, this line item consisted of the following:

	<u>2013</u>	<u>2012</u>
	Euro	
Rental costs for capacity	109,817,252	116,950,631
Interconnection costs	58,079,681	74,815,235
Leases	21,287,425	20,898,905
Contents of internet and mobile service	8,631,042	12,377,473
Other	755,674	212,179
	<u>198,571,074</u>	<u>225,254,423</u>

26. Supplies and external services

In the financial years ended 31 December 2013 and 2012, this line item consisted of the following:

	<u>2013</u>	<u>2012</u>
	Euro	
Support services	92,036,982	84,095,238
Commissions	70,766,272	64,287,368
Specialized work	25,024,286	31,483,543
Maintenance and repairs	29,356,171	30,835,907
Electricity	15,153,555	14,167,250
Rentals	13,669,486	12,405,388
Disposal of space	8,203,280	6,483,923
Communications	5,170,197	5,935,293
Transportation	3,809,897	4,070,337
Other	3,153,085	8,132,492
	<u>266,343,211</u>	<u>261,896,739</u>

At 31 December 2013 and 2012, the Company's future liabilities for operating leases had the following maturities:

	<u>2013</u>	<u>2012</u>
	Euro	
Up to 1 year	53,265,651	61,647,285
Between 1 and 2 years	13,658,387	40,467,372
Between 2 and 3 years	11,066,696	11,149,980
Between 3 and 4 years	9,845,863	9,395,535
Between 4 and 5 years	8,736,038	8,279,865
More than 5 years	23,696,640	26,024,967
	<u>120,269,275</u>	<u>156,965,004</u>

MEO—Serviços de Comunicações e Multimédia, S.A.
Annex to the Financial Statements (Continued)
As of and for 31 December 2013
(Amounts expressed in Euros)

27. Wages and salaries

In the financial years ended 31 December 2013 and 2012, this line item consisted of the following:

	<u>2013</u>	<u>2012</u>
	Euro	
Salaries	37,569,513	35,607,140
Social Security charges	7,964,807	8,025,560
Healthcare	582,896	574,649
Training	426,949	181,315
Social events	269,209	227,052
Other	252,294	253,098
	<u>47,065,668</u>	<u>44,868,814</u>

28. Indirect taxes

In the financial years ended 31 December 2013 and 2012, this line item consisted of the following:

	<u>2013</u>	<u>2012</u>
	Euro	
Anacom taxes	13,772,974	15,256,934
Value Added Tax	303,542	16,275
Other	500,872	498,886
	<u>14,577,388</u>	<u>15,772,095</u>

29. Other income and gains

In the financial years ended 31 December 2013 and 2012, the detail for this line item was as follows:

	<u>2013</u>	<u>2012</u>
	Euro	
Supplemental income ^(a)	8,197,625	9,917,138
Interest due	1,737,568	1,918,363
Recovery of accounts receivable	1,905,591	1,655,043
Gains on exchange rate differences	1,447,051	1,316,873
Gains in inventories	183,906	261,121
Other	1,420,212	899,290
	<u>14,891,953</u>	<u>15,967,828</u>

(a) This line item includes essentially income from renting out space.

MEO—Serviços de Comunicações e Multimédia, S.A.
Annex to the Financial Statements (Continued)
As of and for 31 December 2013
(Amounts expressed in Euros)

30. Other expenses and losses

In the financial years ended 31 December 2013 and 2012, this line item consisted of the following:

	2013	2012
	Euro	
Write-off of tangible fixed assets ^(a)	1,921,812	2,400,905
Losses in inventories	1,758,740	1,503,287
Losses on exchange rate differences	1,458,853	1,434,249
Discounts granted	326,162	362,514
Direct write-off of accounts receivable	243,190	310,136
Other ^(b)	8,824,330	16,044,013
	14,533,087	22,055,104

(a) The amounts in this line item in 2013 and 2012 are explained essentially by write-offs due to the process of inventorying hardware and software.

(b) This item essentially reflects non-recurring adjustments to handle collection risk for certain accounts receivable.

31. Depreciation and amortisation ((losses)/reversals)

This line item in the financial years ended 31 December 2013 and 2012 consisted of the following:

	2013	2012
	Euro	
Tangible fixed assets (Note 6)	113,655,271	117,784,979
Intangible assets (Note 8)	54,576,214	63,001,196
	168,231,485	180,786,175

32. Interest and related income/expenses

In the financial years ended 31 December 2013 and 2012, these line items consisted of the following:

	2013	2012
	Euro	
Interest and related income		
Interest income	410,326	468,450
Other	27,861	914,203
	438,187	1,382,653
Interest and related expenses		
Interest expense	18,043,431	18,364,882
Bank commissions and expenses	474,685	610,516
Finance leases	144,752	166,137
Other	156,913	3,323,362
	18,819,781	22,464,897

MEO—Serviços de Comunicações e Multimédia, S.A.
Annex to the Financial Statements (Continued)
As of and for 31 December 2013
(Amounts expressed in Euros)

32. Interest and related income/expenses (Continued)

The details for interest income and expense in the financial years ended 31 December 2013 and 2012 are as follows:

	2013	2012
	Euro	
Interest income		
Short-term investments	410,326	463,290
Intragroup loans	—	5,160
	410,326	468,450
Interest expense		
Intragroup loans	16,202,563	16,213,321
Other ^(a)	1,840,868	2,151,561
	18,043,431	18,364,882

(a) This line item essentially reflects the effect of the financial updating of the liability associated with the acquisition of the 4G/LTE license (Note 17), completed in December 2011.

33. Earnings per share

Earnings per share in the financial years ended 31 December 2013 and 2012 were calculated as follows:

	2013	2012
	Euro	
Net income	336,146,179	251,574,189
Number of shares	9,400,000	9,400,000
Basic earnings per share	35.76	26.76

There are no situations that give rise to dilution, such that diluted earnings per share are equal to basic earnings per share.

34. Guarantees and other financial commitments

At 31 December 2013 and 2012, the Company had the following guarantees and other financial commitments in favour of third parties:

	2013	2012
	Euro	
Guarantees in favour of courts	105,370	112,031
Bank guarantees in favor of other entities:		
Anacom	24,000,000	30,000,000
Ministry of Justice	2,859,806	2,863,418
Other	2,023,980	2,397,784
	28,883,786	35,261,202
Total guarantees	28,989,156	35,373,233
Commitments of purchase before:		
Fixed asset and content suppliers	8,981,302	21,383,567
Suppliers of inventories	8,264,400	30,193,567
Other services	12,387,759	14,608,520
	29,633,461	66,185,654

MEO—Serviços de Comunicações e Multimédia, S.A.
Annex to the Financial Statements (Continued)
As of and for 31 December 2013
(Amounts expressed in Euros)

34. Guarantees and other financial commitments (Continued)

The bank guarantee provided in favour of Anacom at 31 December 2013, in the amount of 24,000,000 Euros, was requested by Anacom in the context of the auction of spectrum usage rights, and corresponds to the total amount of the outstanding instalments (Note 17).

At 31 December 2013, the value for the bank guarantees provided in favour of other entities includes, essentially, the amount of 1.5 million Euros in respect of contracts to use stores.

The commitments of purchase refer to: (i) orders placed and not satisfied, essentially to acquire telecommunications infrastructure and equipment, in the normal course of business, in the total amount of 17,245,702 Euros; and (ii) service orders placed and not satisfied, in the normal course of business, in the amount of 12,387,759 Euros.

35. Events occurred after the balance sheet date

The financial statements as of and for the year ended 31 December 2013 were approved by the Board of Directors and authorised for issuance on 4 February 2014, and are still subject to approval at the General Shareholders' Meeting, under the terms of applicable commercial law in Portugal.

There were no significant events after 31 December 2013 that would require adjustments or disclosure in these financial statements.

36. Note added for translation

The accompanying financial statements are a translation of financial statements originally issued in Portuguese in conformity with NCRS, some of which may not conform to or be required by generally accepted accounting principles in other countries. In the event of discrepancies, the Portuguese language version prevails.

TMN

Financial Statements

AUDITORS' REPORT

Introduction

1. We have audited the accompanying financial statements of TMN—Telecomunicações Móveis Nacionais, S.A. (“the Company”), presently denominated MEO—Serviços de Comunicações e Multimédia, S.A., which comprise the balance sheet as of 31 December 2012 that presents a total of 6,777,665,631 Euros and shareholders’ equity of 5,802,214,129 Euros, including a net income of 251,574,189 Euros, the statements of income by nature, of changes in shareholders’ equity and of cash flows for the year then ended and the corresponding notes.

Responsibilities

2. The preparation of financial statements that present a true and fair view of the financial position of the Company, the results of its operations, the changes in its shareholders’ equity and its cash flows, as well as the adoption of adequate accounting principles and criteria and the maintenance of an appropriate system of internal control are the responsibility of the Company’s Board of Directors. Our responsibility is to express a professional and independent opinion on these financial statements, based on our audit.

Scope

3. Our audit was performed in accordance with the auditing standards (“*Normas Técnicas e as Diretrizes de Revisão/Auditoria*”) issued by the Portuguese Institute of Statutory Auditors (“*Ordem dos Revisores Oficiais de Contas*”), which require that the audit be planned and performed with the objective of obtaining reasonable assurance about whether the financial statements are free of material misstatement. An audit includes verifying, on a sample basis, evidence supporting the amounts and disclosures in the financial statements and assessing the significant estimates, based on judgements and criteria defined by the Board of Directors, used in their preparation. An audit also includes assessing the adequacy of the accounting principles used and their disclosure, taking into consideration the circumstances, verifying the applicability of the going concern concept and assessing the adequacy of the overall presentation of the financial statements. We believe that our audit provides a reasonable basis for expressing our opinion.

Opinion

4. In our opinion, the financial statements referred to in paragraph 1 above, present fairly, for the purpose explained in paragraph 5 below, in all material respects, the financial position of TMN—Telecomunicações Móveis Nacionais, S.A. as of 31 December 2012 and the results of its operations, the changes in its shareholders’ equity and its cash flows for the year then ended, in conformity with generally accepted accounting principles in Portugal.

Emphases

5. The financial statements mentioned in paragraph 1 above refer to the Company on a standalone basis and were prepared in accordance with current legislation for approval and publication. The Company did not prepared consolidated financial statements as, in accordance with number 3 of article 7 of Decree-Law 158/2009, of 13 July 2009 was not required to do so, as its financial statements were included in the consolidated financial statements of Portugal Telecom, SGPS, S.A.. As described in Note 3.6, although the financial investments have been accounted for by the equity method, under which the Company’s net profit for the year and shareholders’ equity include the effect of consolidating the subsidiaries, the accompanying financial statements do not include the effects of a full consolidation of their assets, liabilities, revenues and costs.
6. As of 31 December 2012, the Company’s financial investments included the wholly-owned subsidiary PT Móveis, S.A. (“PT Móveis”), which owned 100% interest in Bratel BV, a holding company that essentially owned the investment in Oi, S.A. and its controlling shareholders in the total amount of 2,979 million Euros. In connection with the business combination between Portugal Telecom, SGPS, S.A. (“PT SGPS”) and Oi, as of 2 May 2014 this investment was sold to PT SGPS and PT Móveis incurred in a net loss of approximately 950 million Euros, of which 1,000 million Euros did not have an impact in the PT Móveis shareholders’ equity as it corresponds to a transfer to net income of the cumulative amount of negative foreign currency translations adjustments that

were recorded directly in shareholders' equity between March 2011 (Oi's acquisition date) and 2 May 2014 (of which 350 million Euros recorded at 31 December 2012), while the remaining 50 million Euros corresponds to a capital gain reflecting the difference between the selling price and the carrying value of the investment in the books of PT Móveis.

Lisbon, 14 November 2014

Deloitte & Associados, SROC S.A.
Represented by João Luís Falua Costa da Silva

TMN—TELECOMUNICAÇÕES MÓVEIS NACIONAIS, S.A.

BALANCE SHEETS

31 DECEMBER 2012 AND 2011

(Translation of balance sheets originally issued in Portuguese—Note 36)

	Notes	2012	2011
		Euros	
ASSETS			
Non-current assets			
Tangible fixed assets	6	530,538,646	547,867,647
Goodwill	7	10,169,655	10,169,655
Intangible assets	8	397,186,672	424,828,645
Financial investments—equity method of accounting	9,10	5,432,502,015	5,670,077,380
Other financial assets	12	17,802	95,951,774
Deferred tax assets	13	47,012,872	44,013,796
Total non-current assets		6,417,427,662	6,792,908,897
Current assets			
Inventories	14	21,346,581	26,824,927
Trade receivables	15	201,889,814	214,143,349
Unbilled revenues	15	104,201,086	133,859,939
Advances to suppliers		4,697,634	4,867,787
State and other public entities	16	275,246	2,859
Shareholders and group companies	10	—	9,221,948
Other accounts receivable	17	10,310,982	12,724,421
Deferrals	11	9,759,416	6,784,356
Other financial assets	12	—	37,124,881
Cash and bank deposits	4	7,757,210	52,787,099
Total current assets		360,237,969	498,341,566
Total assets		6,777,665,631	7,291,250,463
SHAREHOLDERS' EQUITY			
Share capital	18	47,000,000	47,000,000
Legal reserve	18	9,400,000	9,400,000
Other reserves		(246,879)	(189,875)
Adjustments to financial assets	18	5,203,390,307	5,459,199,597
Retained earnings		291,096,512	286,096,512
Net income	18	251,574,189	285,819,987
Total shareholders' equity		5,802,214,129	6,087,326,221
LIABILITIES			
Non-current liabilities			
Provisions	19	1,006	—
Loans obtained	20	341,311,519	343,367,496
Deferrals		—	640,167
Deferred tax liabilities	13	212,773	319,159
Other accounts payable	17	19,082,848	23,087,862
Other financial liabilities	12	34,932,378	130,517,511
Total non-current liabilities		395,540,524	497,932,195
Current liabilities			
Provisions	19	19,476,917	19,942,038
Loans obtained	20	40,402,346	6,487,175
Deferrals	11	52,281,265	54,129,554
Accounts payable to group companies	10	2,894,767	8,892,468
Trade payables	21	214,393,137	196,985,401
Investment suppliers	21	48,393,524	83,399,284
Accrued expenses	22	139,490,100	146,232,661
Advances from clients		3,883,876	3,262,332
State and other public entities	16	10,361,808	11,463,232
Other accounts payable	17	48,333,238	138,073,021
Other financial liabilities	12	—	37,124,881
Total current liabilities		579,910,978	705,992,047
Total liabilities		975,451,502	1,203,924,242
Total liabilities and shareholders' equity		6,777,665,631	7,291,250,463

The accompanying notes form an integral part of these financial statements

The Accountant

The Board of Directors

TMN—TELECOMUNICAÇÕES MÓVEIS NACIONAIS, S.A.

INCOME STATEMENTS
FOR THE YEARS ENDED 31 DECEMBER 2012 AND 2011

(Translation of statements of changes in shareholders' equity originally issued in Portuguese—Note 36)

	Notes	2012	2011
Euros			
Services rendered	23	1,064,618,344	1,151,092,469
Sales	23	88,691,659	92,923,147
Operating subsidies		31,191	—
Earnings of affiliated companies, net	24	68,573,630	50,340,710
Own work capitalized	8	3,933,263	2,909,014
Costs of products sold	14	(107,376,947)	(109,304,435)
Direct costs	25	(225,254,423)	(226,266,258)
Marketing and publicity		(23,566,649)	(29,617,992)
External Supplies and Services	26	(261,896,739)	(279,553,388)
Wages and salaries	27	(44,868,814)	(48,041,638)
Indirect taxes	28	(15,772,095)	(15,388,176)
Impairment of inventories ((losses)/reversals)	14	4,061,061	1,402,513
Impairment of accounts receivable ((losses)/reversals) . . .	15	(11,166,860)	(5,006,649)
Provisions (increases/reductions)	19	(396,864)	2,622,488
Other income	29	15,967,828	18,375,806
Other expenses	30	(22,055,104)	(19,422,408)
INCOME BEFORE DEPRECIATION AND AMORTISATION, FINANCING EXPENSES AND TAXES		533,522,481	587,065,203
Depreciation and amortisation ((increase)/decrease)	31	(180,786,175)	(194,421,638)
OPERATING INCOME (BEFORE FINANCING EXPENSES AND TAXES)		352,736,306	392,643,565
Interest and related income	32	1,382,653	5,627,127
Interest and related expenses	32	(22,464,897)	(22,928,249)
INCOME BEFORE TAXES		331,654,062	375,342,443
Income tax	13	(80,079,873)	(89,522,456)
NET INCOME		251,574,189	285,819,987
Earnings per share	33	26.76	30.41

The accompanying notes form an integral part of these financial statements.

The Accountant

The Board of Directors

TMN—TELECOMUNICAÇÕES MÓVEIS NACIONAIS, S.A.
STATEMENTS OF CHANGES IN SHARHOLDERS' EQUITY
FOR THE YEARS ENDED 31 DECEMBER 2012 AND 2011

(Translation of statements of changes in shareholders' equity originally issued in Portuguese)

		Share capital	Legal Reserve	Other reserves	Adjustment to financial assets
					Euros
Balance at 1 January 2011	A	47,000,000	9,400,000	—	1,863
Changes:					
Foreign currency translation adjustments		—	—	—	(229,436,015)
Unpaid dividends		—	—	—	5,689,037,476
Other changes in shareholders' equity		—	—	(189,875)	(403,727)
	B	—	—	(189,875)	5,459,197,734
Net income	C				
Comprehensive income	B+C				
Repayment of supplementary capital contributions		—	—	—	—
Application of earnings	D	—	—	—	—
Balance at 31 December 2011	E=A+B+C+D	47,000,000	9,400,000	(189,875)	5,459,199,597
Changes:					
Foreign currency translation adjustments		—	—	—	(350,110,383)
Unpaid dividends		—	—	—	45,340,711
Other changes in shareholders' equity		—	—	(57,004)	48,960,382
	F	—	—	(57,004)	(255,809,290)
Net income	G				
Comprehensive income	F+G				
Operations with shareholders:					
Application of earnings		—	—	—	—
	H	—	—	—	—
Balance at 31 December 2012	E+F+G+H	47,000,000	9,400,000	(246,879)	5,203,390,307

F-536

The accompanying notes form an integral part of these financial statements

The Accountant

TMN—TELECOMUNICAÇÕES MÓVEIS NACIONAIS, S.A.

**STATEMENTS OF CASH FLOW
FOR THE YEARS ENDED 31 DECEMBER 2012 AND 2011**

(Translation of statements of cash flow originally issued in Portuguese—Note 36)

	Notes	2012	2011
		Euros	
OPERATING ACTIVITIES			
Collections from clients		1,424,854,955	1,457,483,992
Payments to suppliers		(765,555,039)	(761,958,533)
Payments to employees		(48,749,295)	(48,939,460)
Cash flow from operations		610,550,621	646,585,999
Cash receipts relating to income taxes		(92,147,467)	(83,616,092)
Other cash payments, net	4.(a)	(85,798,643)	(86,958,286)
Cash flow from operating activities (1)		432,604,511	476,011,621
INVESTING ACTIVITIES			
Cash receipts relating to:			
Tangible fixed assets		2,319,819	5,024,534
Intangible assets		336,507	1,845,902
Interest and related income		3,398,579	7,793,018
Dividends	4.(b)	5,000,000	—
		11,054,905	14,663,454
Payments relating to:			
Tangible fixed assets		(163,204,445)	(115,187,130)
Intangible assets		(129,389,314)	(52,482,083)
		(292,593,759)	(167,669,213)
Cash flow from investing activities (2)		(281,538,854)	(153,005,759)
FINANCING ACTIVITIES			
Cash receipts relating to:			
Loans obtained	4.(c)	47,025,471	—
Subsidies		31,191	—
		47,056,662	—
Cash payments relating to:			
Loans obtained	4.(c)	(2,446,589)	(268,195,368)
Interest and related expenses		(5,226,344)	(13,462,864)
Dividends	18	(235,479,275)	—
		(243,152,208)	(281,658,232)
Cash flow from financing activities (3)		(196,095,546)	(281,658,232)
Change in cash and cash equivalents (4)=(1)+(2)+(3) .		(45,029,889)	41,347,630
Cash and cash equivalents at the beginning of the period .		52,787,099	11,439,469
Cash and cash equivalents at the end of the period . . .	4.(d)	7,757,210	52,787,099

The accompanying notes form an integral part of these financial statements

The Accountant

The Board of Directors

CONTENTS

1.	Introductory note	F-539
2.	Basis of presentation	F-540
3.	Main accounting policies, judgements and estimates	F-540
4.	Cash flow	F-548
5.	Changes in accounting policies and estimates and errors	F-549
6.	Tangible fixed assets	F-549
7.	Goodwill	F-550
8.	Intangible assets	F-551
9.	Investments—Equity method	F-552
10.	Related parties	F-553
11.	Deferrals	F-558
12.	Other financial assets and liabilities	F-559
13.	Income tax	F-559
14.	Inventories	F-562
15.	Accounts receivable and unbilled revenues	F-563
16.	State and other public entities	F-565
17.	Other receivables and payables	F-565
18.	Shareholders' equity	F-566
19.	Provisions, contingent liabilities and contingent assets	F-567
20.	Loans obtained	F-569
21.	Trade payables	F-570
22.	Accrued expenses	F-571
23.	Services rendered and sales	F-571
24.	Equity in earnings of affiliated companies	F-571
25.	Direct costs	F-572
26.	Supplies and external services	F-572
27.	Personnel costs	F-573
28.	Indirect taxes and rates	F-573
29.	Other income	F-574
30.	Other expenses	F-574
31.	Depreciation and amortization	F-574
32.	Interest and related income/expenses	F-575
33.	Earnings per share	F-575
34.	Guarantees and other financial commitments	F-576
35.	Post balance sheet date occurrences	F-576
36.	Note added for translation	F-576

TMN—Telecomunicações Móveis Nacionais, S.A.
Notes to the financial statements
As of 31 December 2012
(Amounts expressed in euros)

1. Introductory note

TMN—Telecomunicações Móveis Nacionais, S.A. (“the Company” or “TMN”) was founded on 22 March 1991, its main activity being the rendering mobile communication services. It is licenced by *Instituto das Comunicações de Portugal* (“ICP”), currently ICP—*Autoridade Nacional de Comunicações* (“ANACOM”) to render complementary telecommunications services—mobile land services—on national territory, under the terms of the ICP—011/TCM license of 16 March 1992. In accordance with a decision of the Board of Directors of ANACOM of 28 February 2007 the right to use these frequencies was renewed for an additional period of 15 years, up to 16 March 2022. At the end of 2000, TMN was licensed by ANACOM to exploit international mobile communication services under the terms of the IMT 2000/UMTS license of 19 December 2000 under number ICP—02 / UMTS up to 11 January 2016, with the possibility of being renewed for an additional period of 15 years.

In December 2011, TMN was notified by ANACOM, under a spectrum auction carried out between 28 and 30 November that it had acquired a spectrum in the 800 MHz, 1.8 GHz and 2.6 GHz frequency bands for 113 million euros. This enables TMN to render fourth generation mobile services, through Long Term Evolution (“LTE”) technology, which corresponds to evolution of the GSM and UMTS technologies. TMN was licenced to use these frequencies for an initial period of 15 years, renewable for an additional period of 15 years.

In addition the Company can render other telecommunication services in Portugal, including:

- a) TMN is registered to exercise public telecommunication services;
- b) TMN is licensed by ANACOM to render land line telephone services under the terms of ICP—010/99/99-SFT license and to establish and supply a public telecommunications network under the terms of ICP—017/99-RPT license, both for the whole national territory, dated 25 November 1999;
- c) TMN is authorized to render private virtual network services, the access code “70596” having been attributed to it.

In February 2008, Law 12/2008—rendering of Essential Public Services was published, in accordance with which the Company was given a period of 6 months to bring legal action against clients for non-payment, after which, if nothing is done, the liability lapses. In accordance with the law all electronic communication services (and not only land line telephone services) became subject to the new rules.

In 2008, under the Portugal Telecom Group reorganization process, TMN acquired from Portugal Telecom, SGPS, S.A. (“PT SGPS” or “Portugal Telecom”), the participation it held in PT Acessos de Internet Wi-Fi, S.A (“PT Wi-Fi”) having merged it into TMN, effective as of 1 January 2008.

TMN is the sole shareholder of PT Móveis—Serviços de Telecomunicações, SGPS, S.A. (“PT Móveis”). On 27 September 2010, PT Móveis sold to Telefónica Móviles, S.A. the 50% participation that it held in Brasilcel N.V. (a joint venture that controls Vivo, that was founded at the end of 2002 between the Portugal Telecom Group—through PT Móveis—and the Telefónica Group—through Telefónica Móviles, S.A.). Subsequently, on 28 March 2011, Portugal Telecom completed the acquisition process of effective participations of 25.3% in Telemar Norte Leste, S.A. (“Oi”) and 14.1% in Contax, S.A. from the controlling shareholders of the companies for 8,437 million Brazilian Reals. This investment was made by the Portugal Telecom Group through the company Bratel Brasil, in which PT Móveis has an indirect participation of 99%. The terms of the agreements enable Portugal Telecom to share decision making power on financial and operating strategies of the companies acquired and so they have been classified as jointly controlled entities in accordance with IAS 31—Joint Ventures. Consequently, as permitted by the standard, the entities acquired were consolidated proportionately in the consolidated financial statements of Portugal Telecom for 2012, the participations being recognized indirectly in the individual non-consolidated financial statements in accordance with the equity method in the same way as investments in subsidiaries. The Oi Group is the leading operator in telecommunication services in the Brazilian market and the largest land line telecommunication service operator in the South American

TMN—Telecomunicações Móveis Nacionais, S.A.
Notes to the financial statements (Continued)
As of 31 December 2012
(Amounts expressed in euros)

1. Introductory note (Continued)

market in terms of active clients and Contax is one of the leading companies in corporate services and is the leading company in contact service centers in Brazil.

On 30 November 2010 PT Portugal, SGPS, S.A. (“PT Portugal”) sold to PT Comunicações, S.A. (“PT Comunicações”) the entire participation it held in TMN, and so the Company became wholly owned by PT Comunicações.

Under the terms of article 7 of Decree-Law 158/2009, despite having investments in group and associated companies, the Company is exempt from preparing consolidated financial statements since it is directly or indirectly wholly owned by Portugal Telecom, SGPS S.A. (“Portugal Telecom”), which in turn presents consolidated financial statements which include the financial statements of the Company and its subsidiaries.

2. Basis of presentation

The accompanying financial statements were prepared in accordance with the applicable provisions of Portuguese law, as set forth in Decree-Law 158/2009, which approved the Accounting System (*Sistema de Normalização Contabilística*—“SNC”), and in accordance with the conceptual framework, Accounting and Financial Statement Standards (*Normas Contabilísticas e de Relato Financeiro*—“NCRF”) and Interpretation Standards (*Normas Interpretativas*) issued in notices 15652/2009, 15655/2009 and 15653/2009, respectively. The Company first adopted NCRF in 2010, applying NCRF 3—*Adoção Pela Primeira Vez Das NCRF* (“NCRF 3”) is using 1 January 2009 as the transition date for the purpose of presenting these financial statements. As provided for in the Attachment to Decree-Law 158/2009, the Company also applies the International Accounting Standards and International Financial Reporting Standards (“IAS/IFRS”) and respective interpretations (“SIC/IFRIC”) of the IASB, to cover the gaps or omissions relating to specific matters of some transactions or particular situations not provided for by the SNC.

3. Main accounting policies, judgments and estimates

The accompanying financial statements were prepared on a going concern basis. The main accounting policies adopted in preparing these financial statements are explained below and were applied on a consistent basis, unless otherwise indicated.

3.1. Tangible fixed assets

Tangible fixed assets are recorded at the cost of acquisition or production, which includes purchase cost, any costs directly attributable to putting the assets in place in the condition needed to operate as intended and, when applicable, the initial estimated cost the Company expects to incur to dismantle and remove the assets and restore to their original condition the locations in which they were installed.

Subsequent costs are added to the book value for the asset only when it is probable that future economic benefits will flow to the Company and the cost can be reliably measured. Maintenance and repair costs not likely to generate future economic benefits are recognized as an expense in the period in which they are incurred.

TMN—Telecomunicações Móveis Nacionais, S.A.
Notes to the financial statements (Continued)
As of 31 December 2012
(Amounts expressed in euros)

3. Main accounting policies, judgments and estimates (Continued)

Except for land that is not depreciated, depreciation of the other tangible fixed assets is recognized on a straight-line monthly basis, as from the time the asset is ready for use. The annual rates applied reflect the estimated useful life for each asset class, as follows:

<u>Class of asset</u>	<u>Years of useful life</u>
Buildings and other constructions	3-50
Machinery and equipment	3-20
Transport equipment	4-5
Administrative equipment	3-10
Other tangible fixed assets	4-8

The useful lives and the depreciation method are reviewed regularly, the effect of any change in these estimates being recognized prospectively in the income statement.

Gains or losses resulting from a write-off or sale are determined as the difference between the amount received and the book value of the asset, and are recognized in the income statement.

3.2. Leases

Leases are classified as finance leases if they transfer to the lessee substantially all the risks and rewards inherent to possessing the corresponding assets. All other leases are classified as operating leases. Leases are classified based on their substance and not their form.

Assets acquired under finance lease contracts, as well as the corresponding liabilities, are recorded at the beginning of the lease at the lesser of the fair value of the assets and the present value of the minimum lease payments. The lease payments include financial expense and amortization of the capital, financial expenses being imputed in accordance with a constant periodic interest rate on the remaining balance of the liability.

In leases considered as operating leases, the lease payments are recognized as an expense on a straight-line basis over the lease period.

3.3. Concentration of business activities and goodwill

Acquisitions of investments in subsidiary companies are recorded using the purchase method. Acquisition cost is determined as the aggregate, at the acquisition date, of the following components: (a) the fair value of the assets received or receivable; (b) the fair value of the liabilities incurred or assumed; (c) the fair value of equity instruments issued by the Company in exchange for obtaining control over the subsidiary; and (d) the costs directly attributable to the acquisition. When applicable, acquisition cost includes the effect of contingent payments agreed for the transaction, and subsequent changes in such payments are recorded by corresponding entry to the corresponding goodwill.

Goodwill corresponds to the excess of acquisition cost over the fair value of the identifiable assets, liabilities and contingent liabilities of the acquired company, at the acquisition date, in accordance with NCRF 14 *Concentrações de Atividades Empresariais*—"NCRF 14" (Concentration of business activities). If the difference between cost and the fair value of the assets and liabilities acquired is negative, it is recognized as income for the year. Considering the exception provided for in NCRF 3, the Company applied the provisions of NCRF 14 only to acquisitions after 1 January 2009, so that the amounts of goodwill relating to acquisitions prior to that date were retained as initially calculated in accordance with the standard applicable at the time.

Goodwill resulting from the acquisition of subsidiary companies is included on the balance sheet caption "Goodwill."

TMN—Telecomunicações Móveis Nacionais, S.A.
Notes to the financial statements (Continued)
As of 31 December 2012
(Amounts expressed in euros)

3. Main accounting policies, judgments and estimates (Continued)

Goodwill is not amortized, being subject to impairment tests on an annual basis or whenever there are indications of a possible loss in value. For purposes of testing impairment, goodwill is allocated to cash-generating units. Any impairment loss is immediately recorded as an expense in the income statement for the period and cannot later be reversed.

3.4. Intangible assets

Intangible assets include, basically (1) rights and licenses, (2) commercial lease rights, (3) terminal equipment assigned to clients under service contracts, and (4) the cost of development activities. Intangible assets acquired separately are recorded at cost, less accumulated amortisation and impairment losses.

Intangible assets are amortised on a straight-line basis in accordance with the following estimated useful lives:

<u>Class of asset</u>	<u>Useful life</u>
UMTS (3G) license	Period of the license with a renewal period (up to 2030)
LTE (4G) license	Period of the license with a renewal period (up to 2042))
Rights over terminal equipment assigned to clients	Contract period (2 Years)
Other intangible assets	3 years

The useful lives and method of amortizing the various intangible assets are reviewed annually, and the effect of any changes in these estimates being recognized prospectively in the income statement.

Research expenses are recognized in the income statement when incurred. Development expenses are capitalized when the technical and economic feasibility of the product or process being developed can be shown and the Company has the intention and capability to complete its development and begin marketing or using it, as provided for in NCRF 6 *Activos Intangíveis* (Intangible assets).

3.5. Impairment of tangible fixed assets and intangible assets

The Company makes impairment tests of its tangible and intangible assets whenever there is an event or change that indicates that the amount at which the asset is recorded may not be recovered. Where there are such indications, the Company determines the recoverable amount of the asset, so as to determine the extent of the impairment loss. When it is not possible to determine the recoverable amount of an asset, the recoverable amount for the cash-generating unit to which the asset belongs is estimated.

In addition, in the specific case of terminal equipment assigned to clients under loyalty contracts, impairment is tested periodically, and the assets are fully written off in cases where the revenue associated with the client giving rise to the intangible asset is not assured.

The recoverable amount is determined as the greater of the sales price and value in use. The sales price is the amount that would be obtained by selling the asset in a transaction between independent knowledgeable entities, fewer costs directly attributable to the sale. Value in use results from future cash flows discounted to reflect the cost of capital and the specific risk of the asset.

Whenever the book value of the asset or of the cash-generating unit exceeds its recoverable amount, an impairment loss is recognized and recorded in the income statement.

TMN—Telecomunicações Móveis Nacionais, S.A.
Notes to the financial statements (Continued)
As of 31 December 2012
(Amounts expressed in euros)

3. Main accounting policies, judgments and estimates (Continued)

3.6. Financial investments

Subsidiary companies are all the entities over which the Company has decision-making power over their financial and operating policies, generally represented by more than half of the voting rights. Associated companies are entities over which the Company exercises significant influence, but do not have control, generally with participations of between 20% and 50% of the voting rights.

Investments in the Company's subsidiaries are recorded using the equity method of accounting.

In accordance with this method, investments are initially recorded at cost and subsequently adjusted based on post-acquisition changes in the Company's interest in the net assets of the corresponding entities. The Company's results include its interest in the corresponding results of these entities.

Investments are tested whenever there are indications that the asset may be impaired, the impairment losses are recorded as expenses in the income statement.

Gains obtained in transactions with subsidiaries are eliminated in proportion to the Company's interest in them, with a corresponding entry to the investment caption.

3.7. Accruals basis

The Company records its income and expenses on an accruals basis, under which income and expenses are recognized as they are generated or incurred, regardless of when they are received or paid, respectively.

3.8. "Qualified Technological Equipment" operations

In prior years the Company entered into "Qualified Technological Equipment" ("QTE") operations under which it sold telecommunication equipment to certain foreign investors. At the same time the investors entered into lease contracts for the equipment with entities founded specifically for the purpose, which signed conditional sales contracts of that equipment with the Company. The Company maintains legal title to the equipment.

The operations correspond to sale and lease-back transactions, the equipment remaining recorded on the balance sheet. Therefore, the Company recorded a current and non-current asset for the sales amount of the equipment and a current and non-current liability for the amount of the lease payments not yet due in the other assets and financial liabilities captions, respectively (Note 12).

In 2012 the contracts in force were terminated early and so the corresponding assets and liabilities were derecognized on the balance sheet.

3.9. Income tax

Income tax corresponds to the sum of current and deferred tax, which are recorded in the income statement except when they relate to items recorded directly in shareholders' equity, in which case they are also recorded in shareholders' equity.

Income tax is estimated based on the estimated taxable income for Corporate Income tax purposes.

Portugal Telecom uses the tax consolidation regime under the *Regime Especial de Tributação de Grupos de Sociedades* ("RETGS"), in which TMN is included. Consequently, estimated Corporate Income Tax, less amounts withheld by third parties and payments in advance, are recorded on the balance sheet as accounts payable to Portugal Telecom.

Income tax for the year recorded in the financial statements is calculated in accordance with NCRF 25 *Impostos Sobre o Rendimento* (Income Tax). In measuring income tax for the year, in addition to current tax determined based on pre-tax results adjusted in accordance with tax law, the effect of temporary

TMN—Telecomunicações Móveis Nacionais, S.A.
Notes to the financial statements (Continued)
As of 31 December 2012
(Amounts expressed in euros)

3. Main accounting policies, judgments and estimates (Continued)

differences between the amounts of assets and liabilities for accounting purposes and the respective amounts for tax purposes are also taken into account. Deferred tax assets and liabilities are calculated annually, using the tax rates that are expected to be in effect on the date of the temporary differences reverse.

Deferred tax assets are recorded only when there is reasonable expectation of the existence of sufficient future taxable profit to use them. At the balance sheet date, the temporary differences underlying the deferred tax assets are reappraised, for the purpose of recognizing unrecorded deferred tax assets due to not having fulfilled the conditions required for recording them, and/or decreasing the amount of the deferred tax assets recognized, due to the current expectation of their future recovery.

3.10. Inventories

Inventories are recorded at the lower of cost and net realizable value. Net realizable value represents estimated sale price less all the estimated costs necessary to complete the sale. The Company uses the average cost method.

Inventory impairment losses include the value of expected unused materials due to technological obsolescence and/or turnover, as well as price differences of materials, the realizable value is less than the average cost, to the extent that it exceeds the discount level considered normal in the business.

3.11. Trade and other accounts receivable

Trade and other accounts receivable are recognized initially at fair value, and are subsequently measured at cost or amortized cost, utilizing the effective interest rate method, less impairment losses.

Impairment of debts of doubtful collection is calculated based on an evaluation of the estimated risks arising from non-collection of accounts receivable, and is recognized in the income statement in the period in which it arises.

3.12. Provisions, liabilities and contingent liabilities

Provisions are recognized by the Company when there is a current obligation resulting from past events, provided it is probable that there will be an outlay of internal resources to settle the obligation and the amount of the outlay can be reasonably estimated. When any of these conditions is not fulfilled, the Company discloses the events as contingent liabilities, unless the possibility of an outflow of funds is remote.

Provisions are recognized at the amount corresponding to the present value of the best estimate, at the reporting date, of the resources needed to settle the liability. The estimate is determined considering the risks and uncertainties associated with the liability. Provisions are reviewed at the end of each year and adjusted so as to reflect the best estimate at that date.

Liabilities relating to costs of dismantling and removing assets installed on third party property and restoring the respective premises to their original condition are recognized when the assets start to be utilized and if it is possible to reliably estimate the respective liability. The amount of the liability recognized corresponds to the present value of the liability, adjustments being recognized in the caption "Other expenses."

3.13. Loans obtained

Loans obtained are initially recognized at fair value, net of transaction costs incurred, and are subsequently adjusted to amortized cost, using the effective interest method.

TMN—Telecomunicações Móveis Nacionais, S.A.
Notes to the financial statements (Continued)
As of 31 December 2012
(Amounts expressed in euros)

3. Main accounting policies, judgments and estimates (Continued)

3.14. Financial expenses on loans obtained

The Company has the policy of capitalizing financial charges relating to loans obtained for the acquisition, construction or production of tangible assets. However, the Company has recognized financial charges as expenses when incurred, given that the construction period for the tangible and intangible assets has been relatively short.

3.15. Balance sheet classification

Assets realizable and liabilities payable in more than one year from the balance sheet date are classified, respectively, as non-current assets and liabilities, at their present value.

3.16. Foreign currency balances and transactions

Foreign currency transactions (those not in the Company's functional currency) are recorded at the exchange rates at the dates of the transactions. Assets and liabilities expressed in foreign currency for which there is no agreement for fixing the exchange rate are translated to Euros using the exchange rates in effect at the balance sheet date. Favorable and unfavorable exchange rate differences, resulting from differences between the exchange rates in effect at the date of the transactions and those in effect at the date of the collections or payments or at the balance sheet date, are recorded as income and expenses in the income statement.

At 31 December 2012 and 2011 assets and liabilities were translated to Euros at the following exchange rates in relation to Euro, as published by Bank of Portugal:

<u>Currency</u>	<u>2012</u>	<u>2011</u>
	<u>Euros</u>	
Swedish Crown	8.5820	8.9120
Special Drawing Right	1.1658	1.1865
US Dollar	1.3194	1.2939
Swiss Franc	1.2072	1.2156
Pound Sterling	<u>0.8161</u>	<u>0.8353</u>

3.17. Revenue

Revenue is measured at the fair value of the consideration received or receivable. Income to be recognized is net of the estimated amount of returns, discounts and other rebates, and does not include Value Added Tax ("VAT") and other taxes paid in connection with the sale.

Revenue from services rendered is recognized by reference to the degree of completion of the transaction at the reporting date, provided that all the following conditions are satisfied: (1) the amount of income can be reliably measured; (2) it is probable that future economic benefits associated with the transaction will flow to the Company; (3) the expenses incurred or to be incurred in the transaction can be reliably measured; and (4) the degree of completion of the transaction at the reporting date can be reasonably estimated.

Revenue from telecommunications activities is recorded at gross value, and unbilled amounts due or generated at the date of the financial statements, are recorded based on estimates and included in the caption "Unbilled income." Differences between the estimated and actual amounts are recorded in the subsequent period.

Revenue relating to advances from clients is deferred, and recognized only when the service is provided.

TMN—Telecomunicações Móveis Nacionais, S.A.
Notes to the financial statements (Continued)
As of 31 December 2012
(Amounts expressed in euros)

3. Main accounting policies, judgments and estimates (Continued)

Revenue from international telecommunications services is calculated based on the termination rates established in bilateral agreements with the various telecommunications operators. The agreements also establish whether it is the operator of origin of the traffic that should present the credit to the operator of the destination country, or whether the latter must present the debit to the former.

The Company operates loyalty programs for some of its customers, under which, based on consumption, clients have the right to loyalty points that can be exchanged for equipment, accessories and discounts on subsequent purchases of services. In the absence of specific SNC standards or interpretations relating to this topic, the Company applies IFRIC 13 Customer Loyalty Programs (“IFRIC 13”), in accordance with which it records these operations as transactions containing multiple elements, such that the amount initially received is allocated between the income relating to the traffic consumed and the points that the customer obtained. Accordingly, the deferred revenue relating to the latter component is recognized when the points are used or expire.

Interest revenue is recognized based on the effective interest method.

3.18. Own work capitalized

Internal expenses incurred by the Company in developing fixed assets, essentially relating to labor, are capitalized with a corresponding entry to the caption “Own work capitalized,” provided the following requirements are fulfilled: (a) the fixed assets developed are identifiable; (b) there is a strong probability that the fixed assets will generate future economic benefits; and (c) the development expenses can be reliably measured.

3.19. Financial assets and liabilities

Financial assets and liabilities are recognized on the balance sheet when the Company becomes party to the corresponding contractual provisions, and are classified as cost or amortized cost.

(a) Financial assets and liabilities at cost or amortized cost

Financial assets and liabilities are classified in the “at cost or amortized cost” category when they present the following characteristics: (a) they are on demand or have established maturities; (b) they have an associated fixed or determinable return; and (c) they are not a derivative financial instrument and do not incorporate a derivative financial instrument.

Financial assets and liabilities considered in this category are measured at cost or amortized cost, less accumulated impairment losses (in the case of financial assets), and correspond essentially to the following asset and liability captions included on the Company’s balance sheet:

- Loans obtained
- Shareholders and Group companies
- Trade receivables
- Trade payables and investment suppliers
- Accrued income and expenses
- Advances to suppliers and from clients
- State and other public entities
- Other receivables and payables
- Other financial assets and liabilities
- Cash and bank deposits

TMN—Telecomunicações Móveis Nacionais, S.A.
Notes to the financial statements (Continued)
As of 31 December 2012
(Amounts expressed in euros)

3. Main accounting policies, judgments and estimates (Continued)

Amortized cost is determined using the effective interest method. The effective interest rate is that which exactly discounts the estimated future payments or receipts during the expected life of the financial instrument to the net book value of the financial asset or liability.

(b) Impairment of financial assets

Financial assets classified in the “at cost or amortized cost” category are subject to impairment tests at the end of each year. The financial assets are impaired when there is objective evidence that, as a result of one or more events occurring after initial recognition, their estimated future cash flows will be affected.

For financial assets measured at amortized cost, impairment loss corresponds to the difference between the book value of the asset and the present value of the new estimated future cash flows discounted at the respective original effective interest rate. For financial assets measured at cost, impairment loss corresponds to the difference between the book value of the asset and the best estimate of the fair value of the asset.

If the impairment loss decreases subsequently as a result of an event occurring after initial recognition of the loss, the impairment must be reversed to results. The reversal is carried out only up to the limit of the amount that would be recognized (amortized cost) had the loss not been initially recorded.

Impairment losses and the respective reversals are recorded in the income statement essentially under the caption “Impairment of accounts receivable ((losses)/reversals).

(c) Derecognition of financial assets and liabilities

The Company derecognizes financial assets only when the contractual rights to the cash flows from the assets expire, or when the financial assets and all the significant risks and benefits associated with their ownership are transferred to another entity. Financial assets transferred for which the Company has retained some significant risks and benefits are derecognized, provided that control over them has been ceded.

The Company derecognizes financial liabilities only when the corresponding obligation is settled, cancelled or expires.

3.20. Main accounting estimates and judgments

In preparing the financial statements in accordance with the NCRF, the Company’s Board of Directors uses estimates and assumptions that affect the application of policies and the amounts reported. The estimates and judgments are continuously evaluated and are based on the experience of past events and other factors, including expectations relating to future events deemed probable in light of the circumstances on which the estimates are based or as the result of information or experience acquired. The most significant accounting estimates reflected in the financial statements are the following:

(a) Useful life of tangible and intangible fixed assets

The Company uses estimates to calculate the useful lives of tangible and intangible fixed assets.

(b) Recognition of provisions and impairment losses

The Company is party to several ongoing legal proceedings for which, based on the opinion of its lawyers, it used its judgment to determine if it should recognize any provision in respect of the contingencies. Impairment of accounts receivable is calculated essentially based on the age of the accounts receivable, the risk profile of the clients and their financial situation.

The estimates were determined based on the best information available at the date the financial statements were prepared. However, there may be events in subsequent periods that, not being foreseeable at the time, were not considered in these estimates. In accordance with NCRF 4 *Políticas*

TMN—Telecomunicações Móveis Nacionais, S.A.
Notes to the financial statements (Continued)
As of 31 December 2012
(Amounts expressed in euros)

3. Main accounting policies, judgments and estimates (Continued)

Contabilísticas, Alterações nas Estimativas Contabilísticas e Erros—“NCRF 4” (Accounting policies, Changes in accounting estimates and Errors), changes to the estimates that occur after the date of the financial statements are corrected prospectively in the income statement. Therefore, given the associated degree of uncertainty, actual results for the transactions in question may differ from the corresponding estimates.

3.21. Post balance sheet date occurrences

Events occurring after the balance sheet date that provide additional information about conditions that existed at the balance sheet date are reflected in the financial statements. Events that occur after the balance sheet date that provide information on conditions that occur after the balance sheet date are not reflected in the financial statements, and are only disclosed if deemed material.

4. Cash flow

For the purposes of the statement of cash flow, “Cash and cash equivalents” includes cash, bank deposits repayable on demand and other very liquid short-term investments with initial maturities of up to three months, net of bank overdrafts, when applicable.

The Company is subject to liquidity risk if the sources of financing, such as cash, operating cash flows and cash flows from divestment transactions and financing, do not meet the existing needs, such as operating cash outflows, investments, shareholder returns and the payment of principal and interest on debt. Based on the cash flows generated by its operations, available cash and the possibility of obtaining financing from Portugal Telecom under the centralized cash management system implemented in the Group, the Company believes it has the capacity to comply with its obligations.

The statement of cash flows was prepared in accordance with NCRF 2 *Demonstração de Fluxos de Caixa* (Statement of Cash Flow), with the following notable aspects:

(a) Other payments, net

This caption includes essentially Value Added Tax and spectrum fees paid to the regulator ICP—Anacom.

(b) Dividend income

In the years ended 31 December 2012 this caption corresponds to dividends received from the subsidiary PT Móveis, in the amount 5,000,000 Euros (Note 9).

(c) Receipts (payments) relating to loans obtained

In 2012 and 2011, payments relating to loans obtained, net of cash receipts relating to loans obtained, is made up as follows:

	2012	2011
	Euros	
Financing under the centralized treasury system	47,025,471	(52,799,489)
Repayment of financing obtained under the commercial paper program (Note 20.3)	—	(49,900,000)
Repayment of shareholders’ loans from Group companies (Note 20.1)	—	(160,000,000)
Finance lease contracts and other financing	(2,446,589)	(5,495,879)
	44,578,882	(268,195,368)

TMN—Telecomunicações Móveis Nacionais, S.A.
Notes to the financial statements (Continued)
As of 31 December 2012
(Amounts expressed in euros)

4. Cash flow (Continued)

(d) Cash and cash equivalents

This caption was made up as follows at 31 December 2012 and 2011:

	2012	2011
	Euros	
Bank deposits repayable on demand	666,374	45,609,699
Cash	7,090,836	7,177,400
Cash and bank deposits	7,757,210	52,787,099

5. Changes in accounting policies and estimates and errors

No new or revised standards or interpretations were adopted in the year ended 31 December 2012, nor were there any voluntary changes in other accounting policies or changes in accounting estimates.

In the year ended 31 December 2012, no other new or revised standards or interpretations were issued that are not yet in force.

In the year ended 31 December 2012 there were no corrections of material prior year errors.

6. Tangible fixed assets

6.1. Changes in tangible fixed assets

The changes in tangible fixed assets in the years ended 31 December 2012 and 2011 were as follows:

	2012							
	Land and natural resources	Buildings and other constructions	Basic equipment	Transport equipment	Administrative equipment	Other tangible fixed assets	Tangible fixed assets in progress	Total
	Euros							
Gross value								
Opening balance	1.022.830	349.835.192	1.129.487.744	9.252.705	323.390.947	5.907.194	58.879.724	1.877.776.336
Acquisitions	—	7.270.676	34.816.306	705.678	9.765.698	30.106	50.514.093	103.102.557
Disposals	—	(16.156)	(68.284)	(980.394)	(94.949)	—	—	(1.159.783)
Transfers and write-offs	—	3.919.518	12.935.444	(38.665)	5.662.618	—	(40.394.925)	(17.916.010)
Closing Balance	1.022.830	361.009.230	1.177.171.210	8.939.324	338.724.314	5.937.300	68.998.892	1.961.803.100
Accumulated amortization and impairment losses								
Opening balance	—	227.023.601	803.787.019	5.593.181	288.466.022	5.038.866	—	1.329.908.689
Amortization for the year (Note 3.1)	—	11.802.448	80.906.266	1.493.905	23.358.750	223.610	—	117.784.979
Disposals	—	(10.271)	(68.271)	(884.331)	(80.800)	—	—	(1.043.673)
Transfers and write-offs	—	(41.496)	(13.310.831)	(8.518)	(2.024.697)	—	—	(15.385.541)
Closing Balance	—	238.774.282	871.314.183	6.194.237	309.719.275	5.262.476	—	1.431.264.454
Tangible fixed assets, net	1.022.830	122.234.948	305.857.027	2.745.087	29.005.039	674.824	68.998.892	530.538.646

TMN—Telecomunicações Móveis Nacionais, S.A.
Notes to the financial statements (Continued)
As of 31 December 2012
(Amounts expressed in euros)

6. Tangible fixed assets (Continued)

	2011							Total
	Land and natural resources	Buildings and other constructions	Basic equipment	Transport equipment	Administrative equipment	Other tangible fixed assets	Tangible fixed assets in progress	
	Euros							
Gross value								
Opening balance	1.022.830	341.233.141	1.591.188.514	10.208.220	302.373.816	5.610.439	41.906.824	2.293.543.784
Acquisitions	—	4.320.398	69.884.312	297.245	10.369.717	296.755	46.914.347	132.082.774
Disposals	—	(14.747)	(540.149.558)	(1.091.551)	(94.036)	—	—	(541.349.892)
Transfers and write-offs	—	4.296.400	8.564.476	(161.209)	10.741.450	—	(29.941.447)	(6.500.330)
Closing Balance	1.022.830	349.835.192	1.129.487.744	9.252.705	323.390.947	5.907.194	58.879.724	1.877.776.336
Accumulated amortization and impairment losses								
Opening balance	—	215.399.495	1.254.440.149	4.895.738	264.482.957	4.456.213	—	1.743.674.552
Amortization for the year (Note 3.1)	—	12.352.551	89.499.668	1.729.142	24.836.958	582.653	—	129.000.972
Disposals	—	(8.459)	(537.362.237)	(981.259)	(57.243)	—	—	(538.409.198)
Transfers and write-offs	—	(719.986)	(2.790.562)	(50.440)	(796.650)	—	—	(4.357.637)
Closing Balance	—	227.023.601	803.787.018	5.593.181	288.466.022	5.038.866	—	1.329.908.689
Tangible fixed assets, net	1.022.830	122.811.591	325.700.726	3.659.524	34.924.925	868.328	58.879.724	547.867.647

The changes in 2012 include investment in tangible fixed assets to be used essentially to increase the capacity of mobile data and quality of the network and expansion of the coverage of the 3G/3,5G and 4G networks;

The changes in 2011 include investments in tangible fixed assets to be used essentially to expand the capacity coverage of the 3G/3,5G network. The sale of basic equipment in 2011 in the net book value of 2.8 million euros, corresponds essentially to sale of the 2G network equipment, which was substituted throughout the year by equipment to render fourth generation services (4G).

6.2. Other matters relating to tangible fixed assets

In prior years, TMN carried out operations with property reserve with foreign investors for the sale of certain telecommunications equipment of its basic network. At the same time the investors signed lease contracts for the equipment with entities founded specifically for the purpose, which in turn signed conditional sales contracts for the equipment with TMN, for the amount of the initial sale. In 2012 the contracts in force were terminated early without significant cost to the Company.

At 31 December 2012 the Company had tangible fixed assets with a net book value of 19,797,082 euros in the hands of third parties.

7. Goodwill

Goodwill at 31 December 2012 and 2011, in the amount of 10,169,655 Euros, was determined in 2007 following the acquisition of the subsidiary PT Wi-Fi, a company that in 2008 was merged into Meo, S.A., as mentioned in Note 1.

TMN—Telecomunicações Móveis Nacionais, S.A.
Notes to the financial statements (Continued)
As of 31 December 2012
(Amounts expressed in euros)

8. Intangible assets

The changes in intangible assets in the years ended 31 December 2012 and 2011 were as follows:

	2012			Total
	Industrial property and other rights	Other intangible assets	Intangible assets in progress	
	Euros			
Gross value				
Opening balance	816,008,835	2,494,179	1,876,767	820,379,781
Acquisitions	37,424,538	91,842	199,317	37,715,697
Disposals	(472,319)	—	—	(472,319)
Transfers and write-offs	(5,350,494)	408,825	(832,660)	(5,774,329)
Closing Balance	847,610,560	2,994,846	1,243,424	851,848,830
Accumulated amortization and impairment losses				
Opening balance	393,156,855	2,394,281	—	395,551,136
Amortization for the year (Note 3.1)	62,900,079	101,117	—	63,001,196
Disposals	(205,202)	—	—	(205,202)
Transfers and write-offs	(3,684,972)	—	—	(3,684,972)
Closing Balance	452,166,760	2,495,398	—	454,662,158
Intangible assets, net	395,443,800	499,448	1,243,424	397,186,672
	2011			
	Industrial property and other rights	Other intangible assets	Intangible assets in progress	Total
	Euros			
Gross value				
Opening balance	671,511,305	2,494,179	302,921	674,308,405
Acquisitions	146,100,488	—	1,870,727	147,971,215
Disposals	(69,481)	—	—	(69,481)
Transfers and write-offs	(1,533,477)	—	(296,881)	(1,830,358)
Closing Balance	816,008,835	2,494,179	1,876,767	820,379,781
Accumulated amortization and impairment losses				
Opening balance	328,921,955	1,978,187	—	330,900,142
Amortization for the year (Note 31)	65,004,572	416,094	—	65,420,666
Disposals	(52,313)	—	—	(52,313)
Transfers and write-offs	(717,359)	—	—	(717,359)
Closing Balance	393,156,855	2,394,281	—	395,551,136
Intangible assets, net	422,851,980	99,898	1,876,767	424,828,645

The acquisitions of intangible assets in the year ended 31 December 2012 relate fundamentally to expenses incurred under loyalty program contracts entered into with clients.

The acquisitions of intangible assets in the year ended 31 December 2011 correspond essentially to (1) the acquisition of rights to use 4G network frequencies (LTE) under which an intangible asset of 106.1 million euros, corresponding to the present value of 113 million euros payable to Anacom, was recorded (Notes 1 and 17) and (2) the present value of terminal equipment ceded to clients under service contracts with them.

TMN—Telecomunicações Móveis Nacionais, S.A.
Notes to the financial statements (Continued)
As of 31 December 2012
(Amounts expressed in euros)

8. Intangible assets (Continued)

At 31 December 2012 the net book value of the caption “Industrial property and other rights” included essentially:

- The amount of 360 million euros relating to the 3G and 4G licenses acquired in 2000 and 2011, respectively, corresponding to a gross amount of 500 million euros net of accumulated amortization of 140 million euros. The gross amount includes essentially:
 - (i) 133 million euros relating to the UMTS license acquired in 2000;
 - (ii) 242 million euros recorded in 2007, under commitments assumed in 2000 by TMN and the other mobile operators to make contributions to the information society during the term of the license, and 11.5 million Euros recorded in 2009 relating to additional commitments under the terms of the UMTS license. At the date the license was granted it was not possible to reliably determine how these commitments would be realized, and so the Company did not record any asset or liability at that date;
 - (iii) 106 million euros relating to the 4G license acquired in 2011.
- The amount of 29 million Euros relating to the cost incurred under post-paid mobile service customer loyalty contracts, which are amortized over the duration of the respective loyalty program contracts (2 years); and
- The amount of 3 million euros relating to software utilization licenses.

During the years ended 31 December 2012 and 2011, the book value of intangible assets included 3,933,263 euros 2,909,014 euros, respectively, for personnel expenses relating to own work capitalized.

In 2012 and 2011 the Company carried out research, development and innovation activities for which other operation expenses and fixed assets in the following amounts were recognized:

	2012	2011
	Euros	
Tangible fixed assets	39,471,223	39,408,128
Intangible assets	976,270	470,687
Operating costs	3,688,018	3,616,135
Total	44,135,511	43,494,950

9. Investments—Equity method

During the years ended 31 December 2012 and 2011 the changes in this caption were as follows (Note 10.2):

	2012	2011
	Euros	
Investment in subsidiary companies		
Opening balance	5,670,077,380	5,849,576,875
Equity method	(232,575,365)	(179,499,495)
Dividends	(5,000,000)	—
Financial investments, net	5,432,502,015	5,670,077,380

TMN—Telecomunicações Móveis Nacionais, S.A.
Notes to the financial statements (Continued)
As of 31 December 2012
(Amounts expressed in euros)

9. Investments—Equity method (Continued)

In the years ended 31 December 2012 and 2011 changes in investments in subsidiary companies resulting from application of the equity method were recorded as follows:

	2012	2011
	Euros	
Gain on subsidiaries (Note 24)	68,574,455	50,340,710
Adjustment in investments (Note 18)	(301,149,820)	(229,840,205)
	(232,575,365)	(179,499,495)

10. Related parties

10.1. Shareholders and group companies

At 31 December 2012 and 2011 the current asset and liability captions “Shareholders and Group companies” were made up as follows:

	2012	2011
	Euros	
DEBIT BALANCES		
Loans granted under the centralized treasury system (Note 10.3)	—	9,221,948
Total debit balances with shareholders and Group companies	—	9,221,948
CREDIT BALANCES		
Accounts payable to PT SGPS under the tax consolidation (RETGS)(a) . . .	613,816	8,892,468
Others	2,280,951	—
Total credit balances with shareholders and Group companies (Note 10.3)	2,894,767	8,892,468

(a) This caption corresponds to accounts payable to PT SGPS under the tax consolidation (RETGS) and relate to estimated Corporate Income Tax, less withholdings at source made by third parties and payments on account.

10.2. Investments in subsidiaries

As mentioned in Note 1, the Company is wholly owned by PT Comunicações, which in turn is wholly owned by PT Portugal, which in turn is owned by Portugal Telecom. Consequently, all the companies that form part of the PT Group were considered as related parties of TMN, including not just its own subsidiaries, but also Portugal Telecom’s other subsidiary companies.

TMN—Telecomunicações Móveis Nacionais, S.A.
Notes to the financial statements (Continued)
As of 31 December 2012
(Amounts expressed in euros)

10. Related parties (Continued)

Details of the investments in the Company's subsidiaries and the main financial information of these entities at 31 December 2012 and 2011 is as follows:

		2012								
Company	Head office	Asset	Liability	Services rendered and sales	Net income	Equity	% held	Financial Investment (Note 9)	Provision for financial investing	Proportion of net income (Note 24)
Subsidiaries										
PT Móveis	Av. Fontes Pereira de Melo, nº 40 1069-300 Lisbon	5,468,958,645	36,456,630	—	68,576,645	5,432,502,015	100.0%	5,432,502,015	—	68,576,645
PT—Sistemas de Informação (PT-SI) (a)	Taguspark—Parque de Ciência e Tecnologia Av. Jacques Delors Edifícios Inovação III e IV 2740-122 Porto Salvo	69,905,903	60,882,617	110,995,705	(3,014,854)	9,023,286	0.1%	—	1,006	(3,015)
								<u>5,432,502,015</u>	<u>1,006</u>	<u>68,573,630</u>
		2011								
Company	Head office	Asset	Liability	Services rendered and sales	Net income	Equity	% held	Financial Investment (Note 9)	Proportion of net income (Note 24)	
Subsidiaries										
PT Móveis	Av. Fontes Pereira de Melo, nº 40 1069-300 Lisbon	5,691,958,493	21,883,304	—	50,338,276	567007518900.0%	100.0%	5,670,075,189	50,338,276	
PT—Sistemas de Informação (PT-SI) (a)	Taguspark—Parque de Ciência e Tecnologia Av. Jacques Delors Edifícios Inovação III e IV 2740-122 Porto Salvo	71,490,375	59,270,750	125,548,899	2,434,436	1221962500.0%	0.1%	2,191	2,434	
								<u>5,670,077,380</u>	<u>50,340,710</u>	

(a) The shareholders' equity of this company includes supplementary capital contributions in the amount of 10,028,970 Euros.

10.3. Balances and transactions with related parties

In addition to debit and credit balances included in "Shareholders and Group companies," as shown above, the Company also has accounts receivable from and payable to related parties under other assets and liabilities captions.

TMN—Telecomunicações Móveis Nacionais, S.A.
Notes to the financial statements (Continued)
As of 31 December 2012
(Amounts expressed in euros)

10. Related parties (Continued)

The nature and details of the main debit balances with related parties at 31 December 2012 and 2011 are as follows:

	2012						
	Trade receivables	Accrued receivables	Deferrals	Advances to suppliers	Other accounts receivable (Note 17)	Total debit balances	
	Euros						
PT Comunicações	18,824,226	4,397,504	698,136	—	942,337	24,862,203	
Unitel SARL	3,369,729	—	—	—	—	3,369,729	
PT—SI	494,551	32,469	708,381	—	45	1,235,446	
Portugal Telecom Inovação, SA ("PT Inovação")	62,807	13,337	365,260	388,397	—	829,801	
PT Centro Corporativo S.A. ("PT Centro Corporativo")	641,312	28,528	—	—	—	669,840	
PT PRO, Serviços Administrativos de Gestão Partilhados, SA ("PT PRO")	593,937	19,131	—	—	91	613,159	
PT Contact-Telemarketing e Serviços de Informática, SA ("PT Contact") .	370,078	11,915	—	—	—	381,993	
CST-Companhia Santomense Telecomunicações, SARL ("CST") .	133,862	—	—	—	—	133,862	
Other companies	671,226	(82,890)	—	19,266	984	608,586	
	<u>25,161,728</u>	<u>4,419,994</u>	<u>1,771,777</u>	<u>407,663</u>	<u>943,457</u>	<u>32,704,619</u>	
	2011						
	Trade receivables	Accrued receivables	Shareholders and Group companies (Note 10.1)	Deferrals	Advances to suppliers	Other accounts receivable (Note 17)	Total debit balances
	Euros						
PT Comunicações	16,916,597	16,328,323	—	625,883	—	292,910	34,163,713
PT SGPS	1,488	—	9,221,948	—	—	191,372	9,414,808
Unitel SARL	2,099,877	—	—	—	—	—	2,099,877
PT—SI	404,641	10,521	—	1,377,516	—	—	1,792,678
PT Contact	488,169	14,551	—	—	—	—	502,720
PT PRO	335,563	22,927	—	—	—	8,492	366,982
Timor Telecom	317,585	—	—	—	—	—	317,585
PT Centro Corporativo .	158,398	33,971	—	—	—	—	192,369
Other companies	575,528	(280,985)	—	—	1,226	79	295,848
	<u>21,297,846</u>	<u>16,129,308</u>	<u>9,221,948</u>	<u>2,003,399</u>	<u>1,226</u>	<u>492,853</u>	<u>49,146,580</u>

TMN—Telecomunicações Móveis Nacionais, S.A.
Notes to the financial statements (Continued)
As of 31 December 2012
(Amounts expressed in euros)

10. Related parties (Continued)

The nature and details of the main credit balances with related parties at 31 December 2012 and 2011 are as follows:

	2012							
	Loans obtained (Note 20)	Shareholders and Group companies (Note 10.1)	Trade payables	Investment suppliers	Accrued expenses	Deferrals	Other payables (Note 17)	Total credit balances
	Euros							
PT Comunicações	340,000,000	2,280,891	63,656,961	1,264,587	42,387,020	85,776	55,358	449,730,593
PT SGPS	37,803,523	613,816	525,647	—	82,291	—	—	39,025,277
PT Contact	—	—	9,332,546	—	12,947,303	1,114	153	22,281,116
PT Inovação	—	—	2,019,091	3,865,267	45,290	12	—	5,929,660
PT—SI	—	60	2,502,510	1,717,686	934,118	1,253	907	5,156,534
UNITEL	—	—	4,932,298	—	—	—	—	4,932,298
PT Centro Corporativo	—	—	1,581	683	3,539,650	(232)	—	3,541,682
PT PRO	—	—	1,854,742	30,806	143,277	8,132	200	2,037,157
Other companies	—	—	689,803	—	(2,021,576)	88,238	(2,017)	(1,245,552)
	377,803,523	2,894,767	85,515,179	6,879,029	58,057,373	184,293	54,601	531,388,765

	2011							
	Loans obtained (Note 20)	Shareholders and Group companies (Note 10.1)	Trade payables	Investment suppliers	Accrued expenses	Deferrals	Other payables (Note 17)	Total credit balances
	Euros							
PT Comunicações	340,000,000	—	39,870,331	22,430,311	32,638,994	114,608	2,931,156	437,985,400
PT Contact	—	—	10,167,646	530,766	13,085,093	807	17,754	23,802,066
PT Centro Corporativo	—	—	6,104,530	91,466	5,259,448	903	1,100	11,457,447
PT SGPS	—	8,892,468	391,241	—	23,639	—	—	9,307,348
PT Inovação	—	—	960,200	5,954,248	77,809	2,540	—	6,994,797
PT—SI	—	—	2,016,196	3,238,142	656,857	181	—	5,911,376
UNITEL	—	—	3,041,768	—	—	—	—	3,041,768
PT PRO	—	—	2,514,606	276,575	192,375	1,156	8,327	2,993,039
Other companies	—	—	484,006	1,648	(450,529)	48,493	(3,015)	80,603
	340,000,000	8,892,468	65,550,524	32,523,156	51,483,686	168,688	2,955,322	501,573,844

TMN—Telecomunicações Móveis Nacionais, S.A.
Notes to the financial statements (Continued)
As of 31 December 2012
(Amounts expressed in euros)

10. Related parties (Continued)

The nature and details of the main transactions with related parties in the years ended 31 December 2012 and 2011 are as follows:

	2012						
	Services rendered and sales	Direct cost of services rendered	Supplies and services	Personnel costs (a)	Other income	Other costs	Net interest expense
	Euros						
PT Comunicações	107.445.442	(139.562.905)	(17.932.147)	(4.750.806)	610.843	(1.901.750)	(14.543.063)
SIRESP Gestão Redes Digitais							
Segurança Emergência, SA	8.880.580	(14.558)	(114)	86.010	4.235.896	—	—
UNITEL	1.781.222	(2.196.594)	—	—	136.938	(37.933)	—
PT—SI	1.120.850	(404.413)	—	—	17.990	(32.906)	—
PT Centro Corporativo	688.065	—	(15.740.207)	1.963.519	—	—	—
CV Móvel	551.873	(96.764)	—	—	13.152	(372)	—
PT PRO	450.597	—	(22.964.195)	106.051	—	7.728	—
PT Inovação	407.283	—	(8.749.337)	1.786.252	—	(499)	—
Timor Telecom	363.785	(77)	(4.706.860)	(13.874)	—	(17.970)	—
PT Contact	258.515	—	(37.074.794)	1.599.493	—	108	—
CST	176.890	(194.974)	—	—	12.530	(8.486)	—
Other companies	1.148.633	(680.559)	(12.344)	1.584.746	75.736	(1.875.786)	(1.665.098)
	123.273.735	(143.150.844)	(107.179.998)	2.361.391	5.103.085	(3.867.866)	(16.208.161)
	2011						
	Services rendered and sales	Direct cost of services rendered	Supplies and services	Personnel costs (a)	Other income	Other costs	Net interest expense
	Euros						
PT Comunicações	45.067.096	(116.663.536)	(14.988.424)	(5.047.528)	1.018.884	(1.882.941)	(21.624.023)
SIRESP Gestão Redes Digitais							
Segurança Emergência, SA	8.385.788	(30.300)	(577)	85.188	5.557.738	—	—
UNITEL	2.139.258	(2.926.561)	—	—	31.206	(149.999)	(4)
PT—SI	619.096	—	(17.676.690)	1.855.514	3	—	—
PT Centro Corporativo	532.132	—	(19.915.554)	98.922	1	—	—
CV Móvel	484.901	(100.282)	—	—	53.219	(33.960)	—
PT PRO	395.722	—	(10.213.851)	1.458.903	2	—	—
PT Inovação	376.983	—	(4.813.417)	(25.470)	2	(17.825)	—
Timor Telecom	350.270	(68.190)	—	—	3.822	(3.027)	—
PT Contact	256.746	—	(39.380.036)	1.219.475	2	—	—
CST	191.095	(53.458)	—	—	843	(2.824)	—
Other companies	708.923	(61.462)	(108.583)	38.218	26.268	(1.147.801)	(21.828)
	59.508.010	(119.903.789)	(107.097.132)	(316.778)	6.691.990	(3.238.377)	(21.645.855)

(a) This caption includes personnel assigned to other companies of the Portugal Telecom Group, in the amounts of 6,348,474 euros in 2012 and 5,451,835 euros in 2011, which were invoiced to these entities and recognized as a deduction from "Wages and salaries." The expenses borne by the Company on personnel assigned by other companies of the Portugal Telecom Group refer essentially to personnel assigned by PT Comunicações, which amounted to 4,233,652 euros in 2012 and 4,934,242 euros in 2011.

TMN—Telecomunicações Móveis Nacionais, S.A.
Notes to the financial statements (Continued)
As of 31 December 2012
(Amounts expressed in euros)

10. Related parties (Continued)

10.4. Other information

The remuneration attributed to members of the Company's corporate boards in the years ended 31 December 2012 and 2011 were as follows:

	<u>2012</u>	<u>2011</u>
	Euros	
Board of Directors		
Fixed remuneration	—	850,972
Variable remuneration	—	384,875
Audit Board		
Statutory audit fees	<u>40,000</u>	<u>50,000</u>
	<u>40,000</u>	<u>1,285,847</u>

Remuneration of the members of the Board of Directors became fully borne by PT Portugal.

11. Deferrals

These captions were made up as follows at 31 December 2012 and 2011:

	<u>2012</u>	<u>2011</u>
	Euros	
EXPENSES TO BE RECOGNIZED		
Current		
Direct costs	4,974,597	4,833,160
Maintenance and repairs	2,745,797	1,412,231
Marketing and publicity	1,411,866	583
Rent and lease	311,317	356,351
Others	<u>315,839</u>	<u>182,031</u>
Total current	<u>9,759,416</u>	<u>6,784,356</u>
INCOME TO BE RECOGNIZED		
Current		
Pre- billing	30,925,007	32,746,299
Client loyalty program	12,073,209	11,586,233
Indemnities for non- contractual compliance by clients	7,866,182	7,339,783
Others	<u>1,416,867</u>	<u>2,457,239</u>
Total current	<u>52,281,265</u>	<u>54,129,554</u>

TMN—Telecomunicações Móveis Nacionais, S.A.
Notes to the financial statements (Continued)
As of 31 December 2012
(Amounts expressed in euros)

12. Other financial assets and liabilities

These captions were made up as follows at 31 December 2012 and 2011:

	2012	2011
	Euros	
Other Financial Assets		
Non- current		
Costumers (note 15)	15,847	96,073
Accounts receivable related to QTE operations(a)	—	95,849,637
Others	1,955	6,064
Total Non-current	17,802	95,951,774
Current		
Accounts receivable related to QTE operations(a)	—	37,124,881
Total corrente	—	37,124,881
Total dos outros ativos financeiros	17,802	133,076,655
Other Financial Liabilities		
Non-current		
Accounts payable related to QTE operations(a)	—	95,849,637
Others (b)	34,932,378	34,667,874
Total Non-current	34,932,378	130,517,511
Current		
Accounts payable related to QTE operations(a)	—	37,124,881
Total current	—	37,124,881
Total other financial liabilities	34,932,378	167,642,392

(a) As explained in Note 3.8, in prior years the Company entered into QTE operations under which it recognized accounts receivable and payable of the same amount, corresponding to the amount of the sale of equipment and the amount of income not yet due under the lease contracts for the equipment, respectively. In 2012 the contracts signed for these operations were terminated early without significant costs for the Company.

(b) At 31 December 2012 and 2011 this caption reflected essentially obligations to dismantle and remove assets installed on third party property and to restore the respective locations to their original condition (Note 3.12), in the amounts of 32,705,960 euros and 32,388,113 euros, respectively.

13. Income tax

13.1. Framework

In 2011 the Company was subject to Corporate Income Tax at the rate of 25%, plus a municipal tax of up to 1.5% on taxable income and a state surcharge of 2.5% on taxable income in excess of 2 million euros, totaling an aggregate maximum of 29.0%. In 2012 the Company is subject to Corporate Income Tax at the rate of 25% plus (i) a municipal tax of up to 1.5% on taxable income and (ii) a state surcharge of 3% and 5% on taxable income between 1.5 and 10 million euros and on taxable income exceeding 10 million euros, respectively, resulting in a maximum aggregate rate of 31.5%. The Company's taxable income for 2012 and 2011 exceeded the above mentioned 10 million and 2 million euro limits and so it applied the tax rates of 31.5% and 29.0% to calculate estimated income tax for 2012 and 2011, respectively, having adjusted the effect of the tax rates applicable to taxable income up to the limits referred to above.

In the calculation of taxable income, to which the tax rates referred to earlier are applicable, costs and income not acceptable for tax purposes are deducted or added to the accounting results.

TMN—Telecomunicações Móveis Nacionais, S.A.
Notes to the financial statements (Continued)
As of 31 December 2012
(Amounts expressed in euros)

13. Income tax (Continued)

The Company is included in the tax consolidation (*Regime Especial de Tributação dos Grupos de Sociedades*—“RETGS”) in which the parent company, PT SGPS, is dominant, and so estimated income tax and withholdings by third parties are recorded on the balance sheet as accounts payable to and receivable from PT SGPS.

In accordance with current legislation, tax returns are subject to review and correction by the tax authorities for four years (five years for Social Security) except when there have been tax losses, tax benefits have been granted, or there are ongoing inspections, complaints or challenges, in which case, depending on the circumstances, the periods are extended or suspended. The Company’s Board of Directors believes, supported by information from its tax advisors that any tax contingencies should not significantly affect the financial statements as of 31 December 2012, considering the provisions recorded and the existing expectations at this time regarding the resolution of the tax contingencies described in Note 19.

13.2. Deferred tax

In determining income tax expense for the year, in addition to current tax determined based on income before tax adjusted in accordance with tax legislation, the effect of temporary differences between income before tax and taxable income, arising in the year or in prior years, are also taken into account.

The changes in deferred tax assets during the years ended 31 December 2012 and 2011 were as follows:

	2012					Total
	Impairment of accounts receivable	Depreciation and amortization of fixed assets	Impairment of inventories	Provisions and adjustments	Other temporary differences	
	Euros					
Opening balance . . .	—	20,501,141	—	22,775,930	736,725	44,013,796
Increase/(decrease)						
Net income	6,673,770	(3,850,567)	1,079,238	(880,361)	(49,216)	2,972,864
Equity	—	—	—	—	26,212	26,212
Closing balance . . .	6,673,770	16,650,574	1,079,238	21,895,569	713,721	47,012,872
	2011					
		Depreciation and amortization of fixed assets		Provisions and adjustments	Other temporary differences	Total
	Euros					
Opening balance		25,947,162		22,492,302	418,717	48,858,181
Increase/(decrease)						
Net income		(7,073,096)		(1,523,986)	179,153	(8,417,929)
Equity		—		—	80,385	80,385
Change in the tax rate						
Net income		1,627,075		1,807,614	51,540	3,486,229
Equity		—		—	6,930	6,930
Closing balance		20,501,141		22,775,930	736,725	44,013,796

TMN—Telecomunicações Móveis Nacionais, S.A.
Notes to the financial statements (Continued)
As of 31 December 2012
(Amounts expressed in euros)

13. Income tax (Continued)

The changes in deferred tax liabilities in the years ended 31 December 2012 and 2011 were as follows:

	2012	
	Other temporary differences	Total
	Euros	
Opening balance	319,159	319,159
Increase/(decrease)		
Net income	(106,386)	(106,386)
Closing balance	212,773	212,773
	2011	
	Other temporary differences	Total
	Euros	
Beginning balance	391,772	391,772
Increase/(decrease)		
Net result	(97,943)	(97,943)
Change in the tax rate		
Net result	25,330	25,330
Closing balance	319,159	319,159

13.3. Reconciliation of the tax rate

In the years ended 31 December 2012 and 2011, reconciliation between the theoretical amount resulting from applying the nominal tax rate to income before tax and income tax expense is as follows:

	2012	2011
	Euros	
Income before tax	331,654,062	375,342,443
Nominal tax rate	31.5%	29.0%
Expected tax	104,471,030	108,849,308
Permanent differences (i)	(22,024,852)	(14,614,284)
Reversal of prior year deferred tax	(4,533,837)	(877,941)
Insufficiency /excess of prior year income tax	2,132,056	(708,292)
Impact of change in the rate on the calculation of deferred tax (ii)	—	(3,460,899)
Others	35,476	334,564
	80,079,873	89,522,456
Income tax		
Current tax	83,159,123	84,663,369
Deferred tax	(3,079,250)	4,859,087
	80,079,873	89,522,456

TMN—Telecomunicações Móveis Nacionais, S.A.
Notes to the financial statements (Continued)
As of 31 December 2012
(Amounts expressed in euros)

13. Income tax (Continued)

(i) Permanent differences are made up as follows:

	2012	2011
	Euros	
Effect of applying the equity method (Note 24)	(68,573,630)	(50,340,710)
Tax benefits	(1,057,306)	(629,560)
Difference between the accounting and tax gains and losses	(8,342)	(606,594)
Provisions and impairment losses not considered for deferred tax purposes	840,940	773,867
Others	(1,121,826)	408,915
	(69,920,164)	(50,394,082)
Nominal tax rate	31.5%	29.0%
	(22,024,852)	(14,614,284)

(ii) This caption corresponds to the impact of a change in the tax rate used to calculate deferred tax, from 29.0% to 31.5% on 31 December 2010 and 2011, respectively, as a result of the change in tax legislation at the end of 2011

13.4. Other information

In accordance with Law 40/2005 of 3 August, which approved the SIFIDE—*Sistema de Incentivos Fiscais em Investigação e Desenvolvimento Empresarial* (System of Tax Incentives for Investigation and Business Development), in 2012 the Company presented its application for 2011 in the amount of 417,152 euros.

The Company included a deduction of 2,344,049 Euros in its tax return for 2012 in accordance with Law 10/2009 of 10 March, which approved the RFAI—*Regime Fiscal de Apoio ao Investimento* (Tax Regime for the Support of Investment), based on significant investments made in new generation broadband networks.

14. Inventories

This caption was made up as follows at 31 December 2012 and 2011:

	2012			2011		
	Gross value	Impairment losses	Net value	Gross value	Impairment losses	Net value
	Euros					
Goods	34,344,331	(14,459,940)	19,884,391	43,860,085	(18,365,977)	25,494,108
Raw, subsidiary and consumable materials	1,584,085	(121,895)	1,462,190	1,607,738	(276,919)	1,330,819
	35,928,416	(14,581,835)	21,346,581	45,467,823	(18,642,896)	26,824,927

TMN—Telecomunicações Móveis Nacionais, S.A.
Notes to the financial statements (Continued)
As of 31 December 2012
(Amounts expressed in euros)

14. Inventories (Continued)

The cost of raw, subsidiary and consumable materials consumed in 2012 and 2011 was determined as follows:

	2012			2011		
	Goods	Materials	Total	Goods	Materials	Total
	Euros					
Opening balance	43,860,085	1,607,738	45,467,823	48,419,220	1,711,251	50,130,471
Purchases	126,406,613	412,345	126,818,958	139,252,811	444,445	139,697,256
Adjustments	(31,080,007)	2,098,589	(28,981,418)	(37,799,268)	2,743,799	(35,055,469)
Closing balance	<u>34,344,331</u>	<u>1,584,085</u>	<u>35,928,416</u>	<u>43,860,085</u>	<u>1,607,738</u>	<u>45,467,823</u>
Cost of products sold and materials consumed	<u>104,842,360</u>	<u>2,534,587</u>	<u>107,376,947</u>	<u>106,012,678</u>	<u>3,291,757</u>	<u>109,304,435</u>

The changes in accumulated impairment losses on inventories in 2012 and 2011 were as follows:

	2012			2011		
	Goods	Materials	Total	Goods	Materials	Total
	Euros					
Opening balance	18,365,977	276,919	18,642,896	20,032,839	12,570	20,045,409
Increase	11,551	—	11,551	566,068	—	566,068
Reversal	(3,917,588)	(155,024)	(4,072,612)	(1,547,981)	(420,600)	(1,968,581)
Other changes	—	—	—	(684,949)	684,949	—
Closing balance	<u>14,459,940</u>	<u>121,895</u>	<u>14,581,835</u>	<u>18,365,977</u>	<u>276,919</u>	<u>18,642,896</u>

15. Accounts receivable and unbilled revenues

These captions were made up as follows at 31 December 2012 and 2011:

	2012			2011		
	Gross value	Impairment losses	Net value	Gross value	Impairment losses	Net value
	Euros					
Trade accounts receivable— current assets	295,799,651	(93,909,837)	201,889,814	313,019,288	(98,875,939)	214,143,349
Trade accounts receivable— non-current assets	15,847	—	15,847	96,073	—	96,073
Trade receivables	<u>295,815,498</u>	<u>(93,909,837)</u>	<u>201,905,661</u>	<u>313,115,361</u>	<u>(98,875,939)</u>	<u>214,239,422</u>
Unbilled revenues	104,201,086	—	104,201,086	133,859,939	—	133,859,939
	<u>400,016,584</u>	<u>(93,909,837)</u>	<u>306,106,747</u>	<u>446,975,300</u>	<u>(98,875,939)</u>	<u>348,099,361</u>

TMN—Telecomunicações Móveis Nacionais, S.A.
Notes to the financial statements (Continued)
As of 31 December 2012
(Amounts expressed in euros)

15. Accounts receivable and unbilled revenues (Continued)

The changes in accumulated impairment losses on trade accounts receivable in 2012 and 2011 were as follows:

	2012	2011
	Euros	
Opening balance	98,875,939	114,325,998
Increase/(reversal)	11,166,860	5,006,649
Utilization (a)	(16,132,962)	(20,456,708)
Closing balance	93,909,837	98,875,939

(a) This caption corresponds to the utilization of accumulated impairment losses to cover doubtful receivables that were considered as uncollectible and had been fully adjusted.

The Company is exposed to credit risk due to the possibility that a counterparty might not fulfill its contractual obligations, resulting in financial loss. Credit risk relates essentially to accounts receivable for services rendered to clients and is monitored regularly with the following objectives: (a) limiting the credit extended to clients, considering their respective profiles and the age of the accounts receivable; (b) monitoring evolution of the level of credit extended; (c) regularly testing of amounts receivable for impairment; and (d) analyzing market risk where the client is located. The Company is not exposed to any significant credit risk relating to any particular client, as its accounts receivable result from a large number of clients.

The aging of accounts receivable net of impairment losses at 31 December 2012 and 2011 was as follows:

	2012			2011		
	Receivables from PT Group companies	Receivables from other companies	Total	Receivables from PT Group companies	Receivables from other companies	Total
	Euros					
Balance not yet due	21,994,249	40,473,715	62,467,964	18,989,514	66,250,113	85,239,627
Balance due						
0-60 days	3,626,042	24,364,021	27,990,063	1,103,922	19,441,106	20,545,028
60-90 days	1,109,927	3,587,679	4,697,606	(295,843)	2,230,515	1,934,672
90-180 days	1,601,762	5,496,429	7,098,191	857,764	5,473,053	6,330,817
180-360 days	(353,868)	9,569,072	9,215,204	745,419	5,405,615	6,151,034
360-720 days	1,706,213	5,014,934	6,721,147	282,831	1,172,843	1,455,674
More than 720 days	1,013,634	82,701,852	83,715,486	858,501	91,724,069	92,582,570
Trade receivables	30,697,959	171,207,702	201,905,661	22,542,108	191,697,314	214,239,422

TMN—Telecomunicações Móveis Nacionais, S.A.
Notes to the financial statements (Continued)
As of 31 December 2012
(Amounts expressed in euros)

16. State and other public entities

The debit and credit balances with the State and other public entities at 31 December 2012 and 2011 are made up as follows:

	2012		2011	
	Debit balance	Credit balance	Debit balance	Credit balance
	Euros			
Value Added Tax	—	8,731,468	—	9,897,766
Social Security	—	896,308	—	886,421
Income tax withholdings	—	723,989	—	672,078
Other taxes	275,246	10,043	2,859	6,967
	275,246	10,361,808	2,859	11,463,232

17. Other receivables and payables

These captions were made up as follows at 31 December 2012 and 2011:

	2012	2011
	Euros	
OTHER RECEIVABLES		
Current		
Group companies (Note 10)	943,457	492,853
Personnel	185,586	43,781
Sundry invoicing	—	11,184
Community subsidies	—	—
Other debtors	9,181,939	12,176,603
Total current	10,310,982	12,724,421
Accumulated impairment losses	—	—
Total other receivables	10,310,982	12,724,421
OTHER PAYABLES		
Non-current		
License LTE	19,082,848	23,087,862
Total Non-current	19,082,848	23,087,862
Current		
Commitments relating to the UMTS licence	35,555,145	34,742,823
LTE licenses	6,000,000	83,000,000
Agents' commission	3,293,131	2,376,975
Related parties (note 10)	54,601	2,955,322
Other creditors	3,430,361	14,997,901
Total current	48,333,238	138,073,021
Total other payables	67,416,086	161,160,883

TMN—Telecomunicações Móveis Nacionais, S.A.
Notes to the financial statements (Continued)
As of 31 December 2012
(Amounts expressed in euros)

18. Shareholders' equity

18.1. Capital

At 31 December 2012 and 2011 the Company's share capital was fully paid up and amounted to 47,000,000 Euros, being represented by 9,400,000 nominal shares of 5 Euros each. The Company's share capital is fully owned by PT Comunicações (Note 1).

18.2. Legal reserve

Commercial legislation and the Company's bylaws establish that at least 5% of annual net income must be appropriated to a legal reserve until the reserve represents 20% of share capital. The reserve cannot be distributed other than in the event of the liquidation of the company, but can be used to absorb losses, after all the other reserves have been exhausted, or for incorporation into capital.

At 31 December 2012 and 2011 the legal reserve was fully constituted in accordance with applicable commercial legislation and amounted to 9,400,000 Euros.

18.3. Adjustments to financial assets

The changes in this caption in 2012 and 2011 were as follows:

	Unpaid dividends	Foreign currency exchanges differences	Other changes in shareholders' equity(b)	Total
	Euros			
Balance at 1 January 2011 . . .	2,165	—	(302)	1,863
Equity method	—	(229,436,015)	(403,727)	(229,839,742)
Unappropriated profit of PT Móveis	5,689,037,476	—	—	5,689,037,476
Balance at 31 December 2011	5,689,039,641	(229,436,015)	(404,029)	5,459,199,597
Equity method	—	(350,110,383)	48,960,382	(301,150,001)
Unappropriated profit of PT Móveis	45,340,711	—	—	45,340,711
Balance at 31 December 2012	5,734,380,352	(579,546,398)	48,556,353	5,203,390,307

(a) This caption corresponds basically to the Company's participation in other changes in shareholders' equity of PT Móveis not resulting from participation in the net result of the subsidiary. In 2012 and 2011 this caption corresponded essentially to negative translation adjustments resulting from depreciation of the Brazilian Real in relation to the Euro in the investment held indirectly in the Oi Group, which was acquired on 28 March 2011 by Bratel Brasil, as explained in Note 1.

(b) The other changes in shareholders' equity in 2012 resulting from application of the equity method relate essentially to gain recorded by Bratel Brasil, in the amount of 49 million euros, resulting from the Oi Group's corporate reorganization in March 2012.

The changes relating to application of the equity method were recorded by corresponding entry to investments recorded in accordance with the equity method as follows:

	2012	2011
	Euros	
Equity investments in subsidiary and associated companies (Note 9)	(301,149,820)	(229,840,205)
Provision for negative investments (Note 19)	(181)	463
	(301,150,001)	(229,839,742)

TMN—Telecomunicações Móveis Nacionais, S.A.
Notes to the financial statements (Continued)
As of 31 December 2012
(Amounts expressed in euros)

18. Shareholders' equity (Continued)

18.4. Appropriation of earnings

In 2011, as decided at the Shareholders' General Meeting held on 25 March 2011, net earnings for 2010, amounting to 5,889,053,625 euros, were appropriated in full to retained earnings.

In 2012, as decided at the Shareholders' General Meeting held on 28 March 2012, net earnings for 2011, amounting to 285,819,986.56 euros, were appropriated as follows: (1) dividends to be distributed of 235,479,275.19 euros; (2) retained earnings of 50,340,711.37 euros.

19. Provisions, contingent liabilities and contingent assets

19.1. Changes in provisions

The changes in provisions in 2012 and 2011 were as follows:

	2012				
	Taxes	Legal processes in progress	Negative investments (Note 10)	Other provisions	Total
			Euros		
Opening balance	3,613,271	11,284,872	—	5,043,895	19,942,038
Increase	1,461,158	—	1,006	—	1,462,164
Decrease	(628,805)	(303,264)	—	(132,225)	(1,064,294)
Utilization	(33,063)	—	—	—	(33,063)
Other changes	(828,922)	—	—	—	(828,922)
Closing balance	3,583,639	10,981,608	1,006	4,911,670	19,477,923

	2011				
	Taxes	Legal processes in progress	Negative investments (Note 10)	Other provisions	Total
			Euros		
Opening balance	3,175,235	15,586,554	463	35,098,297	53,860,549
Increase	789,524	—	—	1,241,158	2,030,682
Decrease	(351,488)	(4,301,682)	(463)	—	(4,653,633)
Other changes	—	—	—	(31,295,560)	(31,295,560)
Closing balance	3,613,271	11,284,872	—	5,043,895	19,942,038

The provision for negative investments is to cover losses in subsidiaries that have negative shareholders' equity (Note 10), and is calculated based on the percentage participation in the capital of these companies. The changes in the provisions in the years ended 31 December 2012 and 2011 were as follows:

	2012	2011
	Euros	
Equity method		
Losses in subsidiary and associated companies (Note 24)	825	—
Adjustments to financial assets (Note 18)	181	(463)
	1.006	(463)

TMN—Telecomunicações Móveis Nacionais, S.A.
Notes to the financial statements (Continued)
As of 31 December 2012
(Amounts expressed in euros)

19. Provisions, contingent liabilities and contingent assets (Continued)

19.2. Processes with probable loss

The provision for taxes is to cover several Corporate Income Tax and Social Security contingencies, as well as other taxes and rates.

The provision for legal processes in progress is to cover liabilities resulting from processes brought against the Company, estimated based on information from its lawyers.

At 31 December 2012 and 2011 the Company, based on the opinion of its internal and external lawyers, classified several legal and arbitration processes in progress and tax contingencies as of probable loss and so it recorded provisions in accordance with NCRF 21—Provisions, Contingent Liabilities and Contingent Assets to cover the probable outflow of resources. The nature of the processes is as follows:

	2012	2011
	Euros	
Legal processes in progress		
Civil responsibility	10,084,018	10,147,398
Labour responsibility	286,871	462,161
Other responsibilities	610,719	675,313
	10,981,608	11,284,872
Tax contingencies	3,583,639	3,613,271
	14,565,247	14,898,143

Processes with possible loss

At 31 December 2012 and 2011, the Company, based on the opinion of its internal and external lawyers, classified several legal and arbitration processes in progress and tax contingencies as of possible loss in accordance with NCRF. The nature of the processes is as follows:

	2012	2011
	Euros	
Legal processes in progress		
Civil responsibility (a)	8,203,539	455,394
Other responsibilities	3,869,544	4,153,953
	12,073,083	4,609,347

(a) The increase in these processes in relation to the preceding year results essentially from the new Noxitel process, dated May 2012, in the amount of 6,000,000 euros, regarding non-contractual compliance, which ended in 2013 without any penalty for the Company.

The Board of Directors believes that any corrections resulting from revisions/inspections of tax returns by the tax authorities will not have a significant effect on the financial statements as of 31 December 2012, considering the provisions recorded and the expectations at this time with respect to the final resolution of the above mentioned matters.

19.3. Other processes

The Company received additional Corporate Income Tax assessments relating to the financial years 2004 to 2009, and a tax inspection report relating to 2010, which essentially question the deductibility of certain financial costs, in the total amount tax amount of 198.5 million euros. The Company disagrees with these assessments and conclusions, and considers, based on the opinion of its tax consultants, that there are solid arguments to oppose the position of the tax authorities.

TMN—Telecomunicações Móveis Nacionais, S.A.
Notes to the financial statements (Continued)
As of 31 December 2012
(Amounts expressed in euros)

19. Provisions, contingent liabilities and contingent assets (Continued)

19.4. Contingent assets

Contingent assets at 31 December 2012 amounted to approximately 4.4 million Euros and correspond essentially to processes brought by the Company against third parties, relating to situations of breach of 2G equipment sales contracts, the rendering of services and lack of payment for Wi-Fi services.

20. Loans obtained

Loans obtained at 31 December 2012 and 2011 are made up as follows:

	2012		2011	
	Non-current	Current	Non-current	Current
	Euros			
Loans from Group companies (Note 10) . .	340,000,000	—	340,000,000	—
Centralized treasury system (Note 10)	—	37,803,523	—	—
Finance leasing	1,311,519	2,577,104	3,367,496	6,375,667
Other financing	—	21,719	—	111,508
	341,311,519	40,402,346	343,367,496	6,487,175

20.1. Loans from Group companies

In June 2010 the Company obtained shareholders' loans from PT Portugal, its previous shareholder, in the amount of 500,000,000 Euros, which did not have an established maturity. On 30 November 2010, these advances were ceded by PT Portugal to PT Comunicações at their nominal amount, under the sale of the participation in TMN. On 2 December 2011, the Company repaid the amount of 160,000,000 Euros relating to these shareholders' loans (Note 4).

20.2. Centralized treasury

Starting on March 2006 Portugal Telecom began centralizing all receipts and payments of the Group companies headquartered in Portugal. The loans obtained by the Company under the centralized cash management system have short-term maturities and bear interest at market rates.

20.3. Commercial paper

On 25 June 1999 Portugal Telecom established a Framework Agreement for the Issuance of Commercial Paper, in which the Company participates, which has been amended several times and at 31 December 2012 was for a maximum of 3,500,000,000 Euros. The framework agreement is in effect until 7 July 2013, and is automatically renewable for successive 2-year periods, until 7 July 2025, unless it is terminated by any of the parties.

On 1 June 2000 Portugal Telecom established a Framework Agreement for the Issuance of Commercial Paper, in which the Company participates, which has been amended several times and, at 31 December 2013, was for a maximum amount of 3,000,000,000 Euros. The contract is in effect until 1 June 2014 and is automatically renewable for successive 2-year periods, until 1 June 2020, unless it is terminated by any of the parties.

At 31 December 2012 and 2011 the Company was not drawn any amount under these programs. In 2011 the Company repaid 49,900,000 euros which was outstanding at 31 December 2010 (Note 4).

20.4. Finance leasing

Financial lease obligations result essentially from: (i) vehicle leases, which generally include purchase options upon termination; and (ii) rights to use transmission capacity over fiber optic circuits.

TMN—Telecomunicações Móveis Nacionais, S.A.
Notes to the financial statements (Continued)
As of 31 December 2012
(Amounts expressed in euros)

20. Loans obtained (Continued)

At 31 December 2012 and 2011 the Company had the following assets recorded on the balance sheet under the finance lease:

	2012			2011		
	Gross value	Accumulated depreciation	Net value	Gross value	Accumulated depreciation	Net Value
	Euros					
Tangible fixed assets						
Transport equipment	4,797,856	2,986,250	1,811,606	5,667,617	3,108,984	2,558,633
Other tangible fixed assets	737,926	272,224	465,702	181,688	68,133	113,555
	<u>5,535,782</u>	<u>3,258,474</u>	<u>2,277,308</u>	<u>5,849,305</u>	<u>3,177,117</u>	<u>2,672,188</u>
Intangible assets						
Industrial property and other rights	2,864,046	1,311,650	1,552,396	14,678,357	8,233,175	6,445,182
	<u>8,399,828</u>	<u>4,570,124</u>	<u>3,829,704</u>	<u>20,527,662</u>	<u>11,410,292</u>	<u>9,117,370</u>

The minimum finance lease contractual payments at 31 December 2012 and 2011 mature as follows

	2012			2011		
	Principal	Interest	Total	Principal	Interest	Total
	Euros					
Up to 1 year	2,577,104	203,515	2,780,619	6,375,667	677,434	7,053,101
From 1 to 2 years	671,392	48,671	720,063	1,675,843	166,696	1,842,539
From 2 to 3 years	501,782	14,337	516,119	1,271,558	57,100	1,328,658
From 3 to 4 years	67,735	5,397	73,132	410,978	4,903	415,881
From 4 to 5 years	70,610	1,667	72,277	9,117	276	9,393
	<u>3,888,623</u>	<u>273,587</u>	<u>4,162,210</u>	<u>9,743,163</u>	<u>906,409</u>	<u>10,649,572</u>

21. Trade payables

The captions “Trade payables” and “Investment suppliers” at 31 December 2012 and 2011 are made up as follows:

	2012	2011
	Euros	
Trade payables		
Current account	209,491,363	185,888,913
Invoices pending approval	4,901,774	11,096,488
	<u>214,393,137</u>	<u>196,985,401</u>
Investment suppliers		
Current account	46,601,212	77,483,995
Invoices pending approval	1,792,312	5,915,289
	<u>48,393,524</u>	<u>83,399,284</u>

TMN—Telecomunicações Móveis Nacionais, S.A.
Notes to the financial statements (Continued)
As of 31 December 2012
(Amounts expressed in euros)

22. Accrued expenses

This caption was made up as follows at 31 December 2012 and 2011:

	2012	2011
	Euros	
Support services	48,931,816	62,231,272
Accrued interest and other financial expenses	27,519,410	13,404,600
Commissions	20,123,148	19,098,275
Direct cost of services rendered and other costs with telecommunications operators	18,013,062	21,918,065
Other supplies and services	10,607,460	12,001,596
Accrued vacation pay, subsidies and other personnel costs	6,179,096	9,588,617
Specialized work	5,817,463	5,307,959
Others	2,298,645	2,682,277
	139,490,100	146,232,661

23. Services rendered and sales

These captions were made up as follows for the years ended 31 December 2012 and 2011:

	2012	2011
	Euros	
Services rendered		
Invoicing	977,459,009	1,025,591,698
Interconnection	68,409,374	99,057,908
Roaming operators	18,749,961	26,442,863
Sales	88,691,659	92,923,147
	1,153,310,003	1,244,015,616

24. Equity in earnings of affiliated companies

This caption is made up as follows for the years ended 31 December 2012 and 2011:

	2012	2011
	Euros	
Gain and loss on subsidiaries		
Gain	68,576,645	50,340,710
Loss	(3,015)	—
	68,573,630	50,340,710

TMN—Telecomunicações Móveis Nacionais, S.A.
Notes to the financial statements (Continued)
As of 31 December 2012
(Amounts expressed in euros)

24. Equity in earnings of affiliated companies (Continued)

Gain and loss on subsidiaries resulting from application of the equity method in the years ended 31 December 2012 and 2011 (Notes 10.2 and 13.3) were recognized by corresponding entry to the following captions:

	2012	2011
	Euros	
Financial Investments (Note 9)		
PT Móveis	68,576,645	50,338,276
PT Sistemas de Informação	(2,190)	2,434
	68,574,455	50,340,710
Provision for negative financial investments (Note 19)		
PT Sistemas de Informação	(825)	—
	68,573,630	50,340,710

25. Direct costs

This caption is made up as follows for the years ended 31 December 2012 and 2011:

	2012	2011
	Euros	
Cost of capacity rent	116,950,631	91,186,377
Interconnection cost	74,815,235	97,281,185
Rent of base stations	20,898,905	20,813,007
Contents of internet and mobile service	12,377,473	16,847,207
Others	212,179	138,482
	225,254,423	226,266,258

26. Supplies and external services

This caption is made up as follows for the years ended 31 December 2012 and 2011:

	2012	2011
	Euros	
Support services	84,095,238	85,295,264
Commission	64,287,368	75,824,545
Specialized work	31,483,543	35,464,858
Maintenance and repairs	30,835,907	31,552,232
Electricity	14,167,250	15,010,358
Rent and lease	12,405,388	13,907,860
Communication	5,935,293	6,276,255
Transport	4,070,337	4,023,148
Fuel, water and other liquids	1,120,578	1,087,134
Travel and lodging	1,110,897	915,873
Insurance	755,284	879,084
Installing, assembling and disconnecting	550,045	259,739
Fees	538,935	444,606
Others (a)	10,540,676	8,612,432
	261,896,739	279,553,388

TMN—Telecomunicações Móveis Nacionais, S.A.
Notes to the financial statements (Continued)
As of 31 December 2012
(Amounts expressed in euros)

26. Supplies and external services (Continued)

The Company's future liability under operating lease contracts matured as follows at 31 December 2012 and 2011:

	<u>2012</u>	<u>2011</u>
	Euros	
Up to 1 year	61,647,285	45,587,612
From 1 to 2 years	40,467,372	12,734,528
From 2 to 3 years	11,149,980	11,639,819
From 3 to 4 years	9,395,535	10,164,841
From 4 to 5 years	8,279,865	8,478,445
More than 5 years	26,024,967	30,135,491
	<u>156,965,004</u>	<u>118,740,736</u>

27. Personnel costs

This caption is made up as follows for the years ended 31 December 2012 and 2011:

	<u>2012</u>	<u>2011</u>
	Euros	
Remuneration	35,607,140	38,414,021
Social charges	8,025,560	8,114,875
Healthcare	574,649	602,108
Social action	227,052	229,095
Training	181,315	433,564
Others	253,098	247,975
	<u>44,868,814</u>	<u>48,041,638</u>

28. Indirect taxes and rates

This caption is made up as follows for the years ended 31 December 2012 and 2011:

	<u>2012</u>	<u>2011</u>
	Euros	
Anacom rates	15,256,934	16,557,661
Value Added Tax ^(a)	16,275	(1,645,062)
Others	498,886	475,577
	<u>15,772,095</u>	<u>15,388,176</u>

(a) This caption in 2011 includes the reversal of costs recorded in prior years relating to Value Added Tax on credit notes issued to clients as the Company believes it will be recovered.

TMN—Telecomunicações Móveis Nacionais, S.A.
Notes to the financial statements (Continued)
As of 31 December 2012
(Amounts expressed in euros)

29. Other income

This caption is made up as follows for the years ended 31 December 2012 and 2011:

	2012	2011
	Euros	
Supplementary income ^(a)	9,917,138	11,350,431
Interest on overdue payments	1,918,363	2,272,280
Recovery of receivables	1,655,043	1,192,075
Exchange gain	1,316,873	2,698,409
Gain on inventories	261,121	687,380
Others	899,290	175,231
	15,967,828	18,375,806

(a) This caption includes essentially income from the rent of space

30. Other expenses

This caption is made up as follows for the years ended 31 December 2012 and 2011:

	2012	2011
	Euros	
Write-off of tangible fixed assets ^(a)	2,400,905	126,168
Losses on inventories	1,503,287	1,774,341
Losses on exchange rate differences	1,434,249	2,711,971
Financial discount allowed	362,514	456,871
Uncollectible receivables	310,136	3,485,196
Others ^(b)	16,044,013	10,867,861
	22,055,104	19,422,408

(a) The increase in this caption in 2012 is due essentially to the substitution of hardware and software equipment due to updating of the NGIN platform that resulted in its write-off.

(b) This item essentially reflects non-recurring adjustments to cover the collection risk of certain accounts receivable.

31. Depreciation and amortization

This caption is made up as follows for the years ended 31 December 2012 and 2011:

	2012	2011
	Euros	
Tangible fixed assets (Note 6)	117,784,979	129,000,972
Intangible assets (Note 8)	63,001,196	65,420,666
	180,786,175	194,421,638

TMN—Telecomunicações Móveis Nacionais, S.A.
Notes to the financial statements (Continued)
As of 31 December 2012
(Amounts expressed in euros)

32. Interest and related income/expenses

These captions are made up as follows for the years ended 31 December 2012 and 2011:

	2012	2011
	Euros	
Interest and related income		
Interest income	468,450	5,414,562
Others	914,203	212,565
	1,382,653	5,627,127
Interest and related expenses		
Interest expense	18,364,882	22,155,201
Finance leasing	166,137	169,742
Commission and other bank charges	610,516	97,582
Others	3,323,362	505,724
	22,464,897	22,928,249

Interest income and expense for the years ended 31 December 2012 and 2011 are made up as follows:

	2012	2011
	Euros	
Interest income		
Term deposits	463,290	5,378,575
Group companies	5,160	35,987
	468,450	5,414,562
Interest cost		
Group companies	16,213,321	21,620,363
Bank loans	2,014	1,863
Others ^(a)	2,149,547	532,975
	18,364,882	22,155,201

(a) The increase in this caption is due essentially to the effect of updating the liability for the acquisition of the 4G/LTE license (Note 17), concluded in December 2011.

33. Earnings per share

Earnings per share for the years ended 31 December 2012 and 2011 were calculated as follows:

	2012	2011
	Euros	
Net income	251,574,189	285,819,987
Number of shares	9,400,000	9,400,000
Basic earnings per share	26.76	30.41

There are no situations that result in dilution and so diluted earnings per share are the same as basic earnings per share.

TMN—Telecomunicações Móveis Nacionais, S.A.
Notes to the financial statements (Continued)
As of 31 December 2012
(Amounts expressed in euros)

34. Guarantees and other financial commitments

At 31 December 2012 and 2011 the Company had the following guarantees and other financial commitments in favour of third parties:

	2012	2011
	Euros	
Bank guarantees in favour of the courts	112,031	109,116
Bank guarantees requested by the Company in favour of third parties:		
Anacom	30,000,000	15,000,000
Tax administration	2,863,418	2,874,128
Others	2,397,784	2,206,927
	35,261,202	20,081,055
Total guarantees	35,373,233	20,190,171
Purchase commitments to:		
Suppliers of fixed assets	21,383,567	34,286,840
Suppliers of inventories	30,193,567	20,826,447
Others	14,608,520	9,433,834
	66,185,654	64,547,121

The bank guarantee provided in favor of Anacom at 31 December 2012, in the amount of 30,000,000 Euros, was requested by Anacom in the auction of spectrum usage rights, and corresponds to the total amount of the outstanding instalments (Note 17).

The bank guarantees provided in favor of other entities at 31 December 2012 includes essentially the amount of 1.7 million Euros in respect of contracts to use shops.

The purchase commitments refer to: (i) orders placed and not satisfied, essentially to acquire telecommunications infrastructure and equipment, in the normal course of business, in the total amount of 51,577,134 euros; and (ii) service orders for the supply of services placed and not satisfied, in the normal course of business, in the amount of 14,608,520 euros.

35. Post balance sheet date occurrences

The financial statements as of 31 December 2012 were approved by the Board of Directors and authorized for issuance on 20 February 2013, being still subject to approval at the Shareholders' General Meeting, under the terms of applicable commercial legislation in Portugal.

There have been no significant events after 31 December 2012 that would require adjustments or disclosure in the accompanying financial statements.

36. Note added for translation

The accompanying financial statements are a translation of financial statements originally issued in Portuguese in conformity with the NCRF, some of which may not conform to or be required by generally accepted accounting principles in other countries. In the event of discrepancies, the Portuguese language version prevails.

THE SENIOR SECURED NOTES ISSUER

Altice Financing S.A.
3, boulevard Royal
L-2449 Luxembourg

THE SENIOR NOTES ISSUER

Altice Finco S.A.
3, boulevard Royal
L-2449 Luxembourg

LEGAL ADVISERS TO THE ISSUERS

*as to matters of
U.S. federal, New York
and English law*

Ropes & Gray International LLP
5 New Street Square
London EC4A 3BF
United Kingdom

*as to matters of
Israeli law*

**Meitar Liguornik Geva
Leshem Tal**
16 Abba Hillel Rd.
Ramat Gan 52506, Israel

*as to matters of
Luxembourg law*

Luther
Aerogolf Center, 1B, Heienhaff,
L-1736 Senningerberg
Luxembourg

*as to matters of
Portuguese law*

Uría Menéndez—Proença de Carvalho
Edifício Rodrigo Uría
Rua Duque de Palmela, 23
1250-097—Lisboa
Portugal

*as to matters of
Swiss law*

Holenstein attorneys-at-law Ltd
Utoquai 29/31
CH-8008 Zurich
Switzerland

*as to matters of
Dominican law*

Castillo y Castillo
Ave. Lope de Vega No. 4
Santo Domingo
Dominican Republic

LEGAL ADVISERS TO THE INITIAL PURCHASERS

*as to matters of
U.S. federal, New York
and English law*

Latham & Watkins (London) LLP
99 Bishopsgate
London EC2M 3XF
United Kingdom

*as to matters of
Israeli law*

Goldfarb Seligman & Co.
Electra Tower
98 Yigal Alon Street
Tel Aviv 67891, Israel

*as to matters of
Luxembourg law*

Elvinger, Hoss & Prussen
2, Place Winston Churchill
BP 425
L-2014 Luxembourg

*as to matters of
Portuguese law*

Cuatrecasas Gonçalves Pereira
Praça Marquês de Pombal, 2
1250-160 Lisbon
Portugal

*as to matters of
Swiss law*

Pestalozzi Attorneys at Law Ltd
Loewenstrasse 1
CH-8001 Zurich
Switzerland

*as to matters of
Dominican law*

Pellerano & Herrera
10 John F Kennedy Ave
Santo Domingo
Dominican Republic

INDEPENDENT AUDITORS FOR THE ISSUER

Deloitte Audit; Société à responsabilité limitée

560, rue de Neudorf
L-2220 Luxembourg

TRUSTEE AND PRINCIPAL PAYING AGENT LEGAL ADVISER TO THE TRUSTEE

**Deutsche Bank AG,
London Branch**
Winchester House
1 Great Winchester Street
London EC2N 2DB
United Kingdom

White & Case LLP
5 Old Broad Street
London EC2N 1DW
United Kingdom

**EURO TRANSFER AGENT AND
EURO REGISTRAR**

Deutsche Bank Luxembourg S.A.
2, Boulevard Konrad Adenauer
L-1115 Luxembourg
Luxembourg

**US PAYING AGENT, US TRANSFER AGENT
US REGISTRAR**

Deutsche Bank Trust Company Americas
60 Wall Street, 16th Floor
New York, New York 10005
USA

SECURITY AGENT

Citibank, N.A., London Branch
Citigroup Centre, 25 Canada Square
Canary Wharf
London, E14 5LB
United Kingdom

You should rely only on the information contained in these Listing Particulars. None of the Issuers (or any of their affiliates) or any of the Initial Purchasers has authorized anyone to provide you with different information. None of the Issuers (or any of its affiliates) or any of the Initial Purchasers is making an offer of the New Notes in any jurisdiction where this offer is not permitted. You should not assume that the information contained in these Listing Particulars are accurate at any date other than the date on the front of these Listing Particulars.

TABLE OF CONTENTS

GENERAL DESCRIPTION OF OUR BUSINESS AND THE OFFERING.....	1
SIMPLIFIED CORPORATE AND FINANCING STRUCTURE.....	19
THE OFFERING.....	23
SUMMARY FINANCIAL INFORMATION AND OTHER DATA.....	30
RISK FACTORS.....	51
THE TRANSACTIONS.....	111
USE OF PROCEEDS.....	113
CAPITALIZATION.....	115
PRO FORMA FINANCIAL INFORMATION OF THE GROUP.....	117
PT PORTUGAL UNAUDITED COMBINED ADJUSTED FINANCIAL INFORMATION.....	154
PT PORTUGAL PRE-CLOSING UNAUDITED COMBINED PRO FORMA BALANCE SHEET.....	168
MANAGEMENT’S DISCUSSION AND ANALYSIS OF FINANCIAL CONDITION AND RESULTS OF OPERATIONS OF THE GROUP.....	171
MANAGEMENT’S DISCUSSION AND ANALYSIS OF FINANCIAL CONDITION AND RESULTS OF OPERATIONS OF THE PT PORTUGAL GROUP.....	236
MANAGEMENT’S DISCUSSION AND ANALYSIS OF FINANCIAL CONDITION AND RESULTS OF OPERATIONS OF ODO.....	266
INDUSTRY AND MARKET OVERVIEW.....	279
DESCRIPTION OF OUR BUSINESS.....	302
DESCRIPTION OF PT PORTUGAL’S BUSINESS.....	337
REGULATORY.....	350
MANAGEMENT AND GOVERNANCE.....	395
PRINCIPAL SHAREHOLDER.....	397
CERTAIN RELATIONSHIPS AND RELATED PARTY TRANSACTIONS.....	398
DESCRIPTION OF OTHER INDEBTEDNESS.....	401
DESCRIPTION OF SENIOR SECURED NOTES.....	434
DESCRIPTION OF SENIOR NOTES.....	535
BOOK-ENTRY, DELIVERY AND FORM.....	625
TRANSFER RESTRICTIONS.....	631
TAX CONSIDERATIONS.....	634
CERTAIN EMPLOYEE BENEFIT PLAN CONSIDERATIONS.....	643
CORPORATE AND FINANCING STRUCTURE.....	646
LIMITATION ON VALIDITY AND ENFORCEABILITY OF THE GUARANTEES AND THE SECURITY INTERESTS.....	652
PLAN OF DISTRIBUTION.....	678
LEGAL MATTERS.....	682
ENFORCEMENT OF JUDGMENTS.....	683
AUDITORS.....	688
LISTING AND GENERAL INFORMATION.....	689
GLOSSARY.....	G-1
INDEX TO FINANCIAL STATEMENTS.....	F-1

€2,317 million (equivalent)

\$2,060,000,000 6⁵/₈% Senior Secured Notes due 2023

€500,000,000 5¹/₄% Senior Secured Notes due 2023

issued by

ALTICE FINANCING S.A.

\$385,000,000

7⁵/₈% Senior Notes due 2025

issued by

ALTICE FINCO S.A.



Joint Lead Bookrunners

Goldman Sachs International

J.P. Morgan

Credit Suisse

Deutsche Bank

Morgan Stanley

BNP PARIBAS

Crédit Agricole CIB

Banca IMI

Citigroup

HSBC

Nomura

RBC Capital Markets

Société Générale

UniCredit Bank

LISTING PARTICULARS
